



**THE DATASHEET OF  
SPMWH22296Q7SGW0S1**



Middle Power LED Series  
2835 0.5W 9V Ra90 Hot bin

# LM283BS+



## Designed for better lm/\$ (Lamps)

### Features & Benefits

- 0.5W Class mid power LED
- Standard form factor for design flexibility (2.8 × 3.5 x 0.65mm)



## Table of Contents

1.	Characteristics	-----	3
2.	Product Code Information	-----	6
3.	Typical Characteristics Graphs	-----	16
4.	Outline Drawing & Dimension	-----	19
5.	Reliability Test Items & Conditions	-----	20
6.	Soldering Conditions	-----	21
7.	Tape & Reel	-----	22
8.	Label Structure	-----	25
9.	Packing Structure	-----	26
10.	Precautions in Handling & Use	-----	30

## 1. Characteristics

### a) Absolute Maximum Rating

Item	Symbol	Rating	Unit	Condition
Ambient / Operating Temperature	$T_a$	-40 ~ +85	°C	-
Storage Temperature	$T_{stg}$	-40 ~ +85	°C	-
LED Junction Temperature	$T_j$	115	°C	-
Forward Current	$I_F$	70	mA	-
Peak Pulsed Forward Current	$I_{FP}$	140	mA	Duty 1/10, pulse width 10ms
Assembly Process Temperature	-	260 <10	°C s	-
ESD (HBM)	-	2	kV	-

**Note:**

Proper current derating must be observed to maintain junction temperature below the maximum at all time.

**b) Electro-optical Characteristics** ( $I_F = 60 \text{ mA}$ ,  $T_s = 25 \text{ }^\circ\text{C}$ )

Item	Unit	Rank	Bin	Min.	Typ.	Max.
Forward Voltage (VF)	V	SG or SK	GZ	8.8	-	9.1
			G1	9.1	-	9.4
			G2	9.4	-	9.7
			G3	9.7	-	10.0
Color Rendering Index (Ra)	-	7		90	-	-
Special CRI (R9)	-	-		50		
Thermal Resistance (junction to solder point)	$^\circ\text{C/W}$			-	15	-
Beam Angle	$^\circ$			-	120	-

**Note:**

Samsung maintains measurement tolerance of: forward voltage =  $\pm 0.2 \text{ V}$ , CRI =  $\pm 3$ , R9 =  $\pm 6.5$

**b) Electro-optical Characteristics (I<sub>F</sub> = 60 mA, T<sub>s</sub> = 25 °C)**

Item	CRI (R <sub>a</sub> ) Min.	Nominal CCT (K)	Bin	60mA	
				Min.	Max.
Luminous Flux (Φ <sub>v</sub> )	90	2700	S1	51.5	56.5
		3000	S1	53.0	58.0
		3500	S1	54.5	59.5
		4000	S1	56.0	61.0
		5000	S1	58.0	63.0
		5700	S1	57.5	62.5
		6500	S1	55.5	60.5

**Note:**

Samsung maintains measurement tolerance of: forward voltage = ±0.2V, luminous flux = ±5 %, CRI = ±3, R9 = ±6.5

## 2. Product Code Information

1	2	3	4	5	6	7	8	9	10	11	12	13	14	15	16	17	18
S	P	M	W	H	2	2	2	9	6	Q	7	S	G	R	0	S	1

Digit	PKG Information	Code	Specification			
1 2 3	Samsung Package Middle Power	SPM	Middle power			
4 5	Color	WH	White			
6	Product Version	2	1st version			
7 8 9	Form Factor	229	2.8 x 3.5 x 0.65 mm; 2 pads; 1chip;			
10	Sorting Current (mA)	6	60 mA			
11	Chromaticity Coordinates	Q	Hot temp			
12	CRI	7	Min. 90			
13 14	Forward Voltage (V)	SG or SK	8.8~10.0	Bin Code	GZ	8.8 ~ 9.1
					G1	9.1 ~ 9.4
					G2	9.4 ~ 9.7
					G3	9.7 ~ 10.0
			SG : 4,000ea per reel ,SK : 16,000ea per reel			
15 16	CCT (K)	W☆	2700	Bin Code:	W1, W2, W3, W4, W5, W6, W7, W8, W9, WA, WB, WC, WD, WE, WF, WG	
		V☆	3000		V1, V2, V3, V4, V5, V6, V7, V8, V9, VA, VB, VC, VD, VE, VF, VG	
		U☆	3500		U1, U2, U3, U4, U5, U6, U7, U8, U9, UA, UB, UC, UD, UE, UF, UG	
		T☆	4000		T1, T2, T3, T4, T5, T6, T7, T8, T9, TA, TB, TC, TD, TE, TF, TG	
		R☆	5000		R1, R2, R3, R4, R5, R6, R7, R8, R9,RA,RB,RC,RD,RE,RF,RG	
		Q☆	5700		Q1, Q2, Q3, Q4, Q5, Q6, Q7, Q8, Q9,QA,QB,QC,QD,QE,QF,QG	
		P☆	6500		P1, P2, P3, P4, P5, P6, P7, P8, P9,PA,PB,PC,PD,PE,PF,PG	
			☆ : "0" (Whole bin) "M" (Quarter bin) or "K" (kitting bin)			
17 18	Luminous Flux	S1	Bin Code	S1		

**a) Luminous Flux Bins ( $I_f = 60 \text{ mA}$ ,  $T_s = 25^\circ\text{C}$ )**

CRI ( $R_a$ ) Min.	Nominal CCT (K)	Product Code	Flux Bin	Flux Range ( $\Phi_v$ , lm)
90	2700	SPMWH22296Q7SGW☆S1	S1	51.5 ~ 56.5
	3000	SPMWH22296Q7SGV☆S1	S1	53.0 ~ 58.0
	3500	SPMWH22296Q7SGU☆S1	S1	54.5 ~ 59.5
	4000	SPMWH22296Q7SGT☆S1	S1	56.0 ~ 61.0
	5000	SPMWH22296Q7SGR☆S1	S1	58.0 ~ 63.0
	5700	SPMWH22296Q7SGQ☆S1	S1	57.5 ~ 62.5
	6500	SPMWH22296Q7SGP☆S1	S1	55.5 ~ 60.5

**Note:**

"☆" can be "0" (Whole bin), "M" (Quarter bin) or "K" (Kitting bin) of the color binning

## b) Kitting rule

### 1) Kitting bin Concept

1. Under agreement between customer and SAMSUNG ELECTRONICS, SAMSUNG can supply kitting bin (VF, Color, Im).
2. A forward voltage (VF) of kitting bin is combined by a pair of same VF rank such as (GZ+GZ), (G1+G1), (G2+G2) or (G3+G3).
3. A Chromaticity Coordinates of kitting bin is mixed by kitting procedure.(below kitting simulation)

### [Kitting example]

D	E	F	G
9	A	B	C
5	6	7	8
1	2	3	4

### [Binning Information]

	Bin #1	Bin #2
VF	GZ	GZ
	G1	G1
	G2	G2
	G3	G3
CIE	1, 2, 5 bin	C, F, G bin
	6, 7, A, B bin	6, 7, A, B bin
	3, 4, 8 bin	9, D, E bin

c) Color Bins ( $I_F = 60 \text{ mA}$ ,  $T_s = 25 \text{ }^\circ\text{C}$ )

CRI ( $R_a$ ) Min.	Nominal CCT (K)	Product Code	Color Rank	Chromaticity Bins
90	2700	SPMWH22296Q7SGW0S1	W0 (Whole bin)	W1, W2, W3, W4, W5, W6, W7, W8, W9, WA, WB, WC, WD, WE, WF, WG
		SPMWH22296Q7SGWMS1	WM (Quarter bin)	W6, W7, WA, WB
		SPMWH22296Q7SGWKS1	WK (Kitting bin)	W1, W2, W3, W4, W5, W6, W7, W8, W9, WA, WB, WC, WD, WE, WF, WG
3000	3000	SPMWH22296Q7SGV0S1	V0 (Whole bin)	V1, V2, V3, V4, V5, V6, V7, V8, V9, VA, VB, VC, VD, VE, VF, VG
		SPMWH22296Q7SGVMS1	VM (Quarter bin)	V6, V7, VA, VB
		SPMWH22296Q7SGVKS1	VK (Kitting bin)	V1, V2, V3, V4, V5, V6, V7, V8, V9, VA, VB, VC, VD, VE, VF, VG
3500	3500	SPMWH22296Q7SGU0S1	U0 (Whole bin)	U1, U2, U3, U4, U5, U6, U7, U8, U9, UA, UB, UC, UD, UE, UF, UG
		SPMWH22296Q7SGUMS1	UM (Quarter bin)	U6, U7, UA, UB
		SPMWH22296Q7SGUKS1	UK (Kitting bin)	U1, U2, U3, U4, U5, U6, U7, U8, U9, UA, UB, UC, UD, UE, UF, UG
4000	4000	SPMWH22296Q7SGT0S1	T0 (Whole bin)	T1, T2, T3, T4, T5, T6, T7, T8, T9, TA, TB, TC, TD, TE, TF, TG
		SPMWH22296Q7SGTMS1	TM (Quarter bin)	T6, T7, TA, TB
		SPMWH22296Q7SGTKS1	TK (Kitting bin)	T1, T2, T3, T4, T5, T6, T7, T8, T9, TA, TB, TC, TD, TE, TF, TG
5000	5000	SPMWH22296Q7SGR0S1	R0 (Whole bin)	R1, R2, R3, R4, R5, R6, R7, R8, R9, RA, RB, RC, RD, RE, RF, RG
		SPMWH22296Q7SGRMS1	RM (Quarter bin)	R6, R7, RA, RB
		SPMWH22296Q7SGRKS1	RK (Kitting bin)	R1, R2, R3, R4, R5, R6, R7, R8, R9, RA, RB, RC, RD, RE, RF, RG
5700	5700	SPMWH22296Q7SGQ0S1	Q0 (Whole bin)	Q1, Q2, Q3, Q4, Q5, Q6, Q7, Q8, Q9, QA, QB, QC, QD, QE, QF, QG
		SPMWH22296Q7SGQMS1	QM (Quarter bin)	Q6, Q7, QA, QB
		SPMWH22296Q7SGQKS1	QK (Kitting bin)	Q1, Q2, Q3, Q4, Q5, Q6, Q7, Q8, Q9, QA, QB, QC, QD, QE, QF, QG
6500	6500	SPMWH22296Q7SGP0S1	P0 (Whole bin)	P1, P2, P3, P4, P5, P6, P7, P8, P9, PA, PB, PC, PD, PE, PF, PG
		SPMWH22296Q7SGPMS1	PM (Quarter bin)	P6, P7, PA, PB
		SPMWH22296Q7SGPKS1	PK (Kitting bin)	P1, P2, P3, P4, P5, P6, P7, P8, P9, PA, PB, PC, PD, PE, PF, PG

d) Voltage Bins ( $I_f = 60 \text{ mA}$ ,  $T_s = 25 \text{ °C}$ )

CRI ( $R_a$ ) Min.	Nominal CCT (K)	Product Code	Voltage Rank	Voltage Bin	Voltage Range (V)
-	-	-		GZ	8.8 ~ 9.1
			SG	G1	9.1 ~ 9.4
			or		
			SK	G2	9.4 ~ 9.7
				G3	9.7 ~ 10.0

e) Chromaticity Region & Coordinates ( $I_F = 60 \text{ mA}$ ,  $T_s = 25 \text{ }^\circ\text{C}$ )

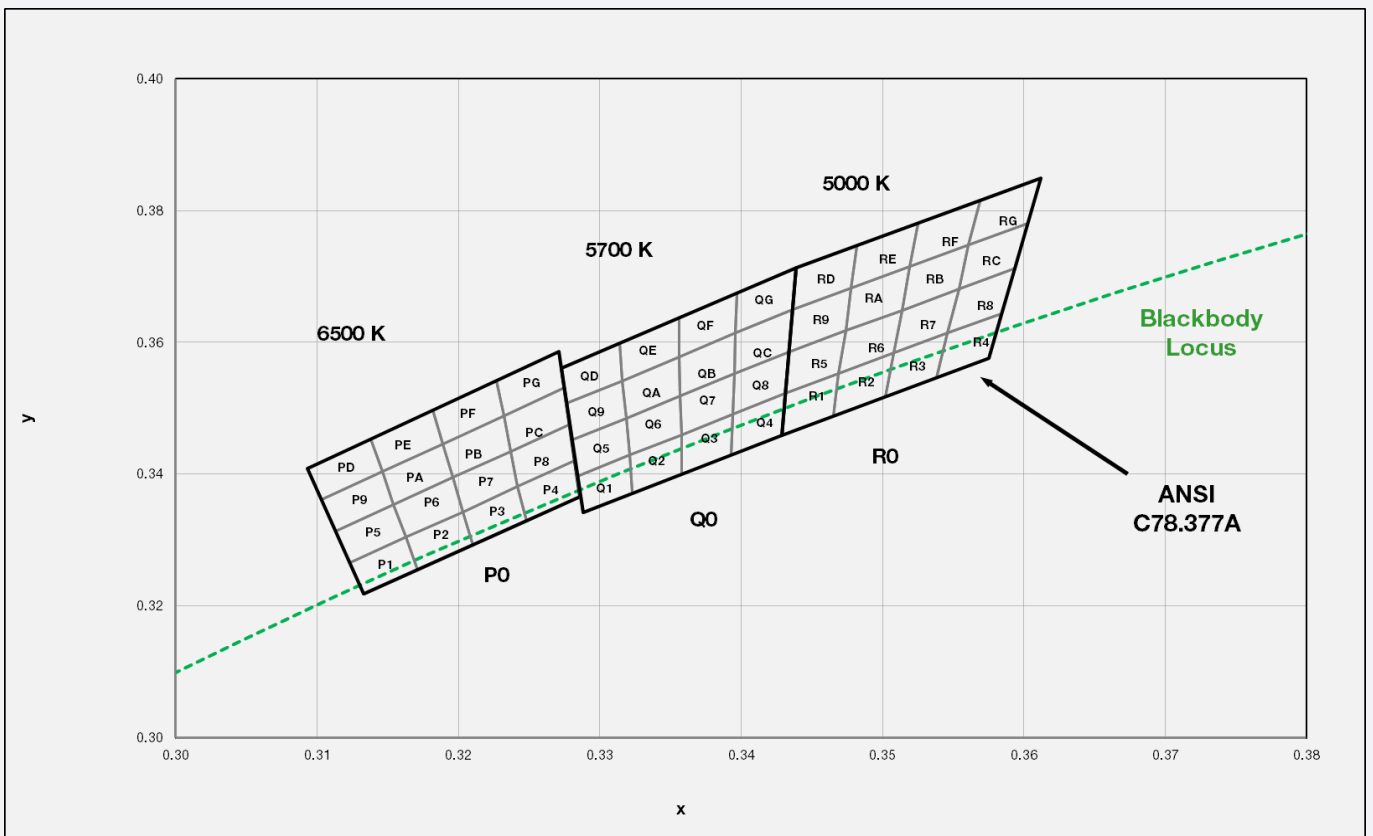
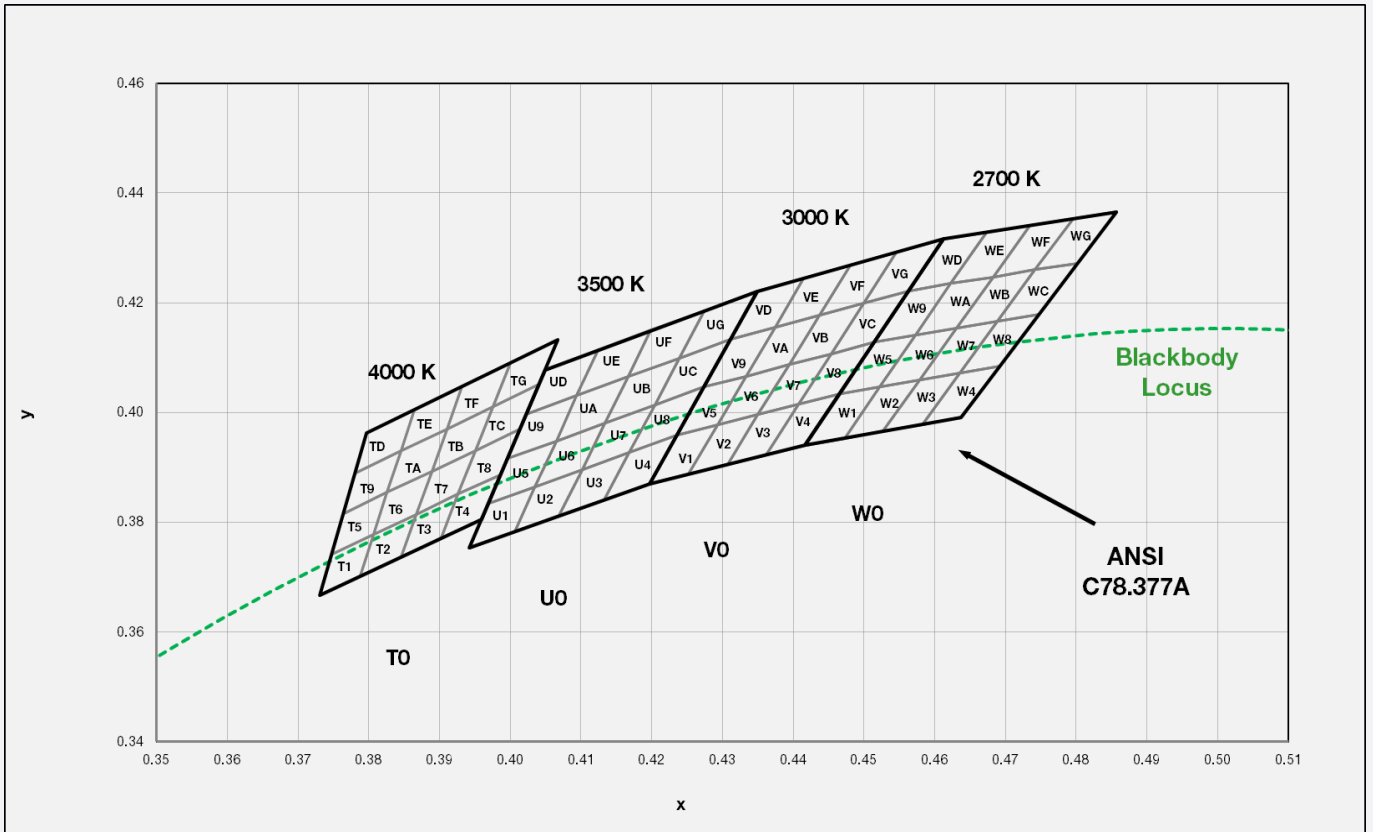

## e) Chromaticity Region &amp; Coordinates

Region	CIE x	CIE y	Region	CIE x	CIE y
<b>W rank (2700 K)</b>					
W1	0.4417	0.3940	W9	0.4515	0.4128
	0.4472	0.3953		0.4573	0.4141
	0.4522	0.4047		0.4623	0.4235
	0.4466	0.4034		0.4563	0.4222
W2	0.4472	0.3953	WA	0.4573	0.4141
	0.4527	0.3966		0.4631	0.4153
	0.4579	0.4059		0.4683	0.4247
	0.4522	0.4047		0.4623	0.4235
W3	0.4527	0.3966	WB	0.4631	0.4153
	0.4582	0.3978		0.4689	0.4166
	0.4635	0.4072		0.4742	0.4260
	0.4579	0.4059		0.4683	0.4247
W4	0.4582	0.3978	WC	0.4689	0.4166
	0.4637	0.3991		0.4747	0.4179
	0.4692	0.4085		0.4802	0.4272
	0.4635	0.4072		0.4742	0.4260
W5	0.4466	0.4034	WD	0.4563	0.4222
	0.4522	0.4047		0.4623	0.4235
	0.4573	0.4141		0.4673	0.4329
	0.4515	0.4128		0.4612	0.4316
W6	0.4522	0.4047	WE	0.4623	0.4235
	0.4579	0.4059		0.4683	0.4247
	0.4631	0.4153		0.4735	0.4341
	0.4573	0.4141		0.4673	0.4329
W7	0.4579	0.4059	WF	0.4683	0.4247
	0.4635	0.4072		0.4742	0.4260
	0.4689	0.4166		0.4796	0.4354
	0.4631	0.4153		0.4735	0.4341
W8	0.4635	0.4072	WG	0.4742	0.4260
	0.4692	0.4085		0.4802	0.4272
	0.4747	0.4179		0.4857	0.4366
	0.4689	0.4166		0.4796	0.4354

Region	CIE x	CIE y	Region	CIE x	CIE y
<b>V rank (3000 K)</b>					
V1	0.4197	0.3870	V9	0.4273	0.4046
	0.4252	0.3888		0.4333	0.4066
	0.4293	0.3977		0.4374	0.4155
	0.4235	0.3958		0.4311	0.4133
V2	0.4252	0.3888	VA	0.4333	0.4066
	0.4307	0.3905		0.4394	0.4087
	0.4350	0.3996		0.4437	0.4178
	0.4293	0.3977		0.4374	0.4155
V3	0.4307	0.3905	VB	0.4394	0.4087
	0.4362	0.3923		0.4454	0.4107
	0.4408	0.4015		0.4500	0.4200
	0.4350	0.3996		0.4437	0.4178
V4	0.4362	0.3923	VC	0.4454	0.4107
	0.4417	0.3940		0.4515	0.4128
	0.4466	0.4034		0.4563	0.4222
	0.4408	0.4015		0.4500	0.4200
V5	0.4235	0.3958	VD	0.4311	0.4133
	0.4293	0.3977		0.4374	0.4155
	0.4333	0.4066		0.4415	0.4245
	0.4273	0.4046		0.4349	0.4221
V6	0.4293	0.3977	VE	0.4374	0.4155
	0.4350	0.3996		0.4437	0.4178
	0.4394	0.4087		0.4481	0.4269
	0.4333	0.4066		0.4415	0.4245
V7	0.4350	0.3996	VF	0.4437	0.4178
	0.4408	0.4015		0.4500	0.4200
	0.4454	0.4107		0.4546	0.4292
	0.4394	0.4087		0.4481	0.4269
V8	0.4408	0.4015	VG	0.4500	0.4200
	0.4466	0.4034		0.4563	0.4222
	0.4515	0.4128		0.4612	0.4316
	0.4454	0.4107		0.4546	0.4292

## e) Chromaticity Region &amp; Coordinates

Region	CIE x	CIE y	Region	CIE x	CIE y
<b>U rank (3500 K)</b>					
U1	0.3942	0.3753	U9	0.3995	0.3916
	0.4006	0.3782		0.4065	0.3948
	0.4035	0.3865		0.4094	0.4031
	0.3969	0.3834		0.4022	0.3997
U2	0.4006	0.3782	UA	0.4065	0.3948
	0.4069	0.3812		0.4134	0.3981
	0.4102	0.3896		0.4167	0.4065
	0.4035	0.3865		0.4094	0.4031
U3	0.4069	0.3812	UB	0.4134	0.3981
	0.4133	0.3841		0.4204	0.4013
	0.4168	0.3927		0.4239	0.4099
	0.4102	0.3896		0.4167	0.4065
U4	0.4133	0.3841	UC	0.4204	0.4013
	0.4197	0.3870		0.4273	0.4046
	0.4235	0.3958		0.4311	0.4133
	0.4168	0.3927		0.4239	0.4099
U5	0.3969	0.3834	UD	0.4022	0.3997
	0.4035	0.3865		0.4094	0.4031
	0.4065	0.3948		0.4124	0.4114
	0.3995	0.3916		0.4049	0.4078
U6	0.4035	0.3865	UE	0.4094	0.4031
	0.4102	0.3896		0.4167	0.4065
	0.4134	0.3981		0.4199	0.4150
	0.4065	0.3948		0.4124	0.4114
U7	0.4102	0.3896	UF	0.4167	0.4065
	0.4168	0.3927		0.4239	0.4099
	0.4204	0.4013		0.4274	0.4185
	0.4134	0.3981		0.4199	0.4150
U8	0.4168	0.3927	UG	0.4239	0.4099
	0.4235	0.3958		0.4311	0.4133
	0.4273	0.4046		0.4349	0.4221
	0.4204	0.4013		0.4274	0.4185

Region	CIE x	CIE y	Region	CIE x	CIE y
<b>T rank (4000 K)</b>					
T1	0.3731	0.3667	T9	0.3764	0.3815
	0.3788	0.3702		0.3826	0.3854
	0.3807	0.3778		0.3845	0.3930
	0.3748	0.3741		0.3781	0.3889
T2	0.3788	0.3702	TA	0.3826	0.3854
	0.3845	0.3736		0.3889	0.3892
	0.3867	0.3814		0.3910	0.3970
	0.3807	0.3778		0.3845	0.3930
T3	0.3845	0.3736	TB	0.3889	0.3892
	0.3902	0.3771		0.3951	0.3931
	0.3926	0.3851		0.3975	0.4011
	0.3867	0.3814		0.3910	0.3970
T4	0.3902	0.3771	TC	0.3951	0.3931
	0.3959	0.3805		0.4013	0.3969
	0.3986	0.3887		0.4040	0.4051
	0.3926	0.3851		0.3975	0.4011
T5	0.3748	0.3741	TD	0.3781	0.3889
	0.3807	0.3778		0.3845	0.3930
	0.3826	0.3854		0.3865	0.4006
	0.3764	0.3815		0.3797	0.3963
T6	0.3807	0.3778	TE	0.3845	0.3930
	0.3867	0.3814		0.3910	0.3970
	0.3889	0.3892		0.3932	0.4048
	0.3826	0.3854		0.3865	0.4006
T7	0.3867	0.3814	TF	0.3910	0.3970
	0.3926	0.3851		0.3975	0.4011
	0.3951	0.3931		0.4000	0.4091
	0.3889	0.3892		0.3932	0.4048
T8	0.3926	0.3851	TG	0.3975	0.4011
	0.3986	0.3887		0.4040	0.4051
	0.4013	0.3969		0.4067	0.4133
	0.3951	0.3931		0.4000	0.4091

e) Chromaticity Region & Coordinates

Region	CIE x	CIE y	Region	CIE x	CIE y
<b>R rank (5000 K)</b>					
R1	0.3429	0.3459	R9	0.3434	0.3586
	0.3465	0.3489		0.3474	0.3618
	0.3469	0.3553		0.3478	0.3682
	0.3431	0.3523		0.3436	0.3650
R2	0.3465	0.3489	RA	0.3474	0.3618
	0.3502	0.3518		0.3514	0.3649
	0.3508	0.3584		0.3519	0.3715
	0.3469	0.3553		0.3478	0.3682
R3	0.3502	0.3518	RB	0.3514	0.3649
	0.3538	0.3547		0.3554	0.3681
	0.3546	0.3614		0.3561	0.3748
	0.3508	0.3584		0.3519	0.3715
R4	0.3538	0.3547	RC	0.3554	0.3681
	0.3575	0.3576		0.3594	0.3713
	0.3584	0.3644		0.3603	0.3781
	0.3546	0.3614		0.3561	0.3748
R5	0.3431	0.3523	RD	0.3436	0.3650
	0.3469	0.3553		0.3478	0.3682
	0.3474	0.3618		0.3482	0.3747
	0.3434	0.3586		0.3439	0.3713
R6	0.3469	0.3553	RE	0.3478	0.3682
	0.3508	0.3584		0.3519	0.3715
	0.3514	0.3649		0.3525	0.3781
	0.3474	0.3618		0.3482	0.3747
R7	0.3508	0.3584	RF	0.3519	0.3715
	0.3546	0.3614		0.3561	0.3748
	0.3554	0.3681		0.3569	0.3815
	0.3514	0.3649		0.3525	0.3781
R8	0.3546	0.3614	RG	0.3561	0.3748
	0.3584	0.3644		0.3603	0.3781
	0.3594	0.3713		0.3612	0.3849
	0.3554	0.3681		0.3569	0.3815

Region	CIE x	CIE y	Region	CIE x	CIE y
<b>Q rank (5700 K)</b>					
Q1	0.3288	0.3342	Q9	0.3280	0.3452
	0.3323	0.3372		0.3319	0.3485
	0.3321	0.3429		0.3316	0.3542
	0.3284	0.3397		0.3276	0.3507
Q2	0.3323	0.3372	QA	0.3319	0.3485
	0.3358	0.3401		0.3357	0.3519
	0.3358	0.3460		0.3356	0.3578
	0.3321	0.3429		0.3316	0.3542
Q3	0.3358	0.3401	QB	0.3357	0.3519
	0.3393	0.3430		0.3395	0.3553
	0.3394	0.3491		0.3396	0.3614
	0.3358	0.3460		0.3356	0.3578
Q4	0.3393	0.3430	QC	0.3395	0.3553
	0.3429	0.3459		0.3434	0.3586
	0.3431	0.3523		0.3436	0.3650
	0.3394	0.3491		0.3396	0.3614
Q5	0.3284	0.3397	QD	0.3276	0.3507
	0.3321	0.3429		0.3316	0.3542
	0.3319	0.3485		0.3314	0.3599
	0.3280	0.3452		0.3273	0.3561
Q6	0.3321	0.3429	QE	0.3316	0.3542
	0.3358	0.3460		0.3356	0.3578
	0.3357	0.3519		0.3356	0.3637
	0.3319	0.3485		0.3314	0.3599
Q7	0.3358	0.3460	QF	0.3356	0.3578
	0.3394	0.3491		0.3396	0.3614
	0.3395	0.3553		0.3397	0.3675
	0.3357	0.3519		0.3356	0.3637
Q8	0.3394	0.3491	QG	0.3396	0.3614
	0.3431	0.3523		0.3436	0.3650
	0.3434	0.3586		0.3439	0.3713
	0.3395	0.3553		0.3397	0.3675

## e) Chromaticity Region &amp; Coordinates

Region	CIE x	CIE y	Region	CIE x	CIE y
<b>P rank (6500 K)</b>					
P1	0.3133	0.3218	P9	0.3113	0.3314
	0.3171	0.3255		0.3154	0.3354
	0.3163	0.3305		0.3146	0.3404
	0.3123	0.3266		0.3103	0.3361
P2	0.3171	0.3255	PA	0.3154	0.3354
	0.3210	0.3292		0.3196	0.3395
	0.3203	0.3343		0.3189	0.3446
	0.3163	0.3305		0.3146	0.3404
P3	0.3210	0.3292	PB	0.3196	0.3395
	0.3248	0.3329		0.3237	0.3435
	0.3242	0.3382		0.3232	0.3489
	0.3203	0.3343		0.3189	0.3446
P4	0.3248	0.3329	PC	0.3237	0.3435
	0.3286	0.3366		0.3279	0.3476
	0.3282	0.3421		0.3275	0.3531
	0.3242	0.3382		0.3232	0.3489
P5	0.3123	0.3266	PD	0.3103	0.3361
	0.3163	0.3305		0.3146	0.3404
	0.3154	0.3354		0.3138	0.3453
	0.3113	0.3314		0.3093	0.3409
P6	0.3163	0.3305	PE	0.3146	0.3404
	0.3203	0.3343		0.3189	0.3446
	0.3196	0.3395		0.3182	0.3498
	0.3154	0.3354		0.3138	0.3453
P7	0.3203	0.3343	PF	0.3189	0.3446
	0.3242	0.3382		0.3232	0.3489
	0.3237	0.3435		0.3227	0.3542
	0.3196	0.3395		0.3182	0.3498
P8	0.3242	0.3382	PG	0.3232	0.3489
	0.3282	0.3421		0.3275	0.3531
	0.3279	0.3476		0.3271	0.3586
	0.3237	0.3435		0.3227	0.3542

**Note:** Samsung maintains measurement tolerance of:  $C_x, C_y = \pm 0.005$

### 3. Typical Characteristics Graphs

#### a) Spectrum Distribution ( $I_f = 60 \text{ mA}$ , $T_s = 25 \text{ }^\circ\text{C}$ )

CCT: 2700 K (90 CRI)

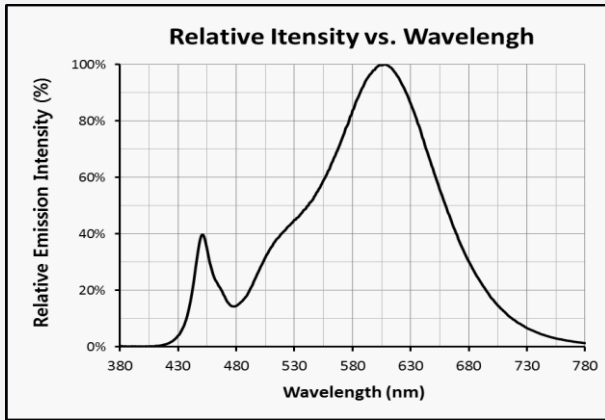

CCT: 3000 K (90 CRI)

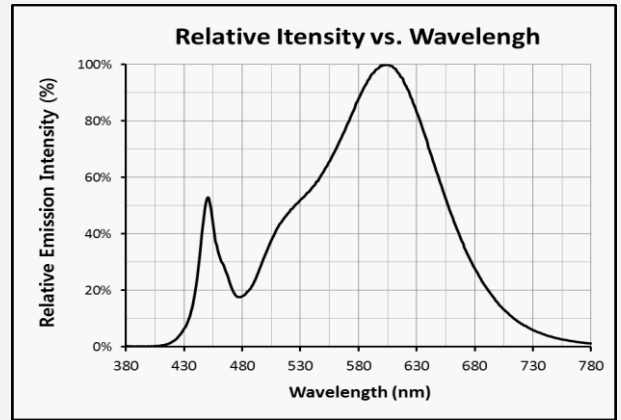

CCT: 3500 K (80 CRI)

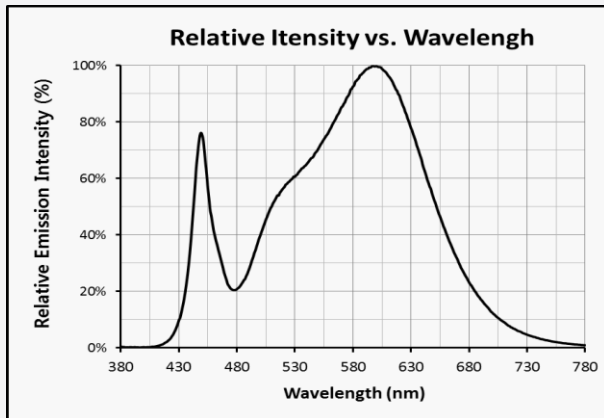

CCT: 4000 K (80 CRI)

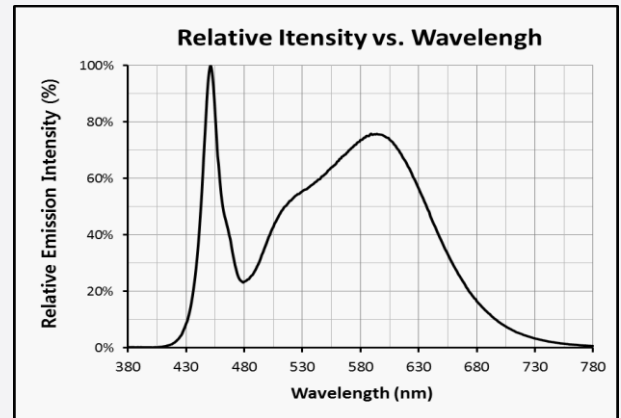

CCT: 5000 K (90 CRI)

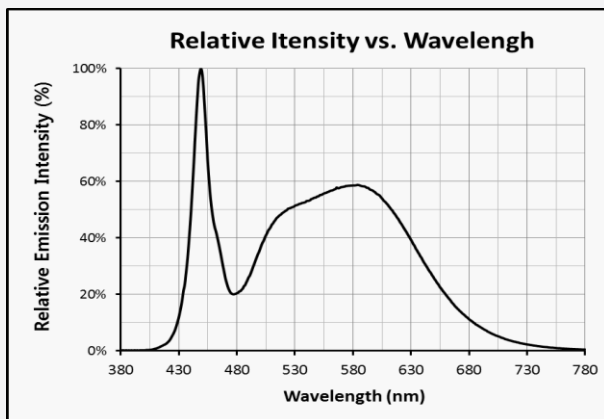

CCT: 5700 K (90 CRI)

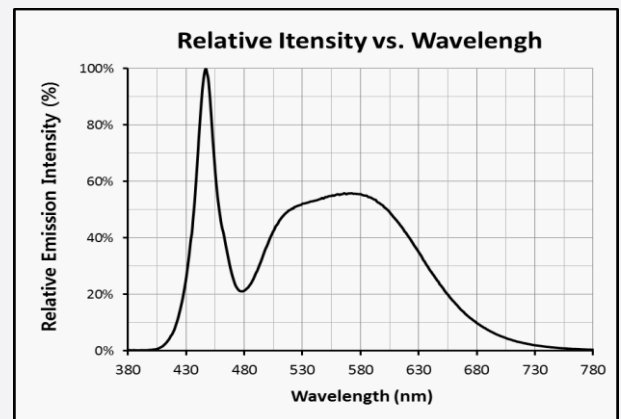

CCT: 6500 K (90 CRI)

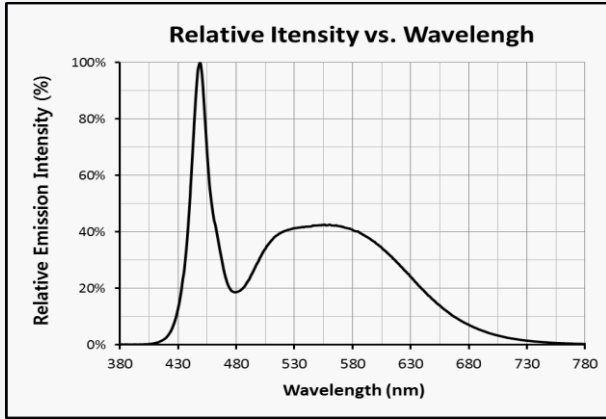

**b) Forward Current Characteristics ( $T_s = 25^\circ\text{C}$ )**

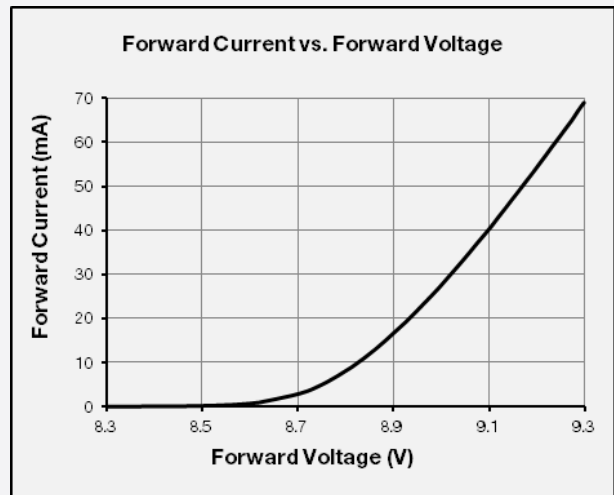
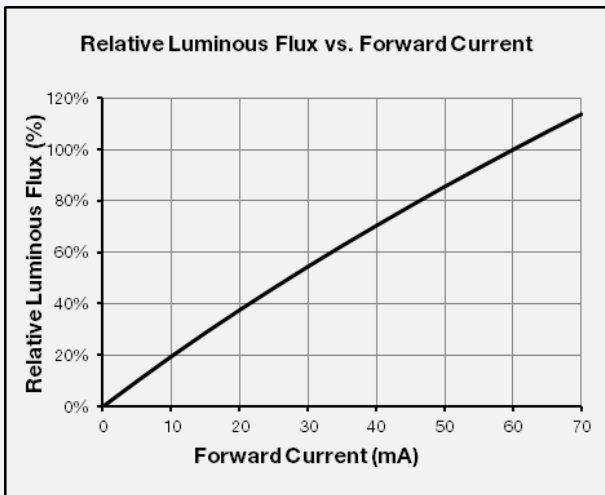

**c) Temperature Characteristics ( $I_F = 60\text{ mA}$ )**

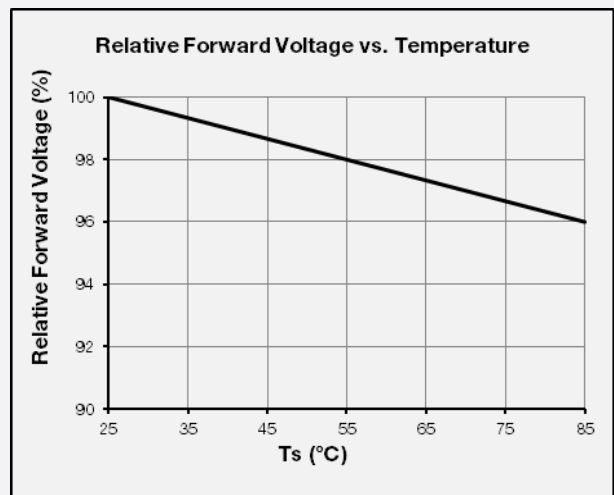
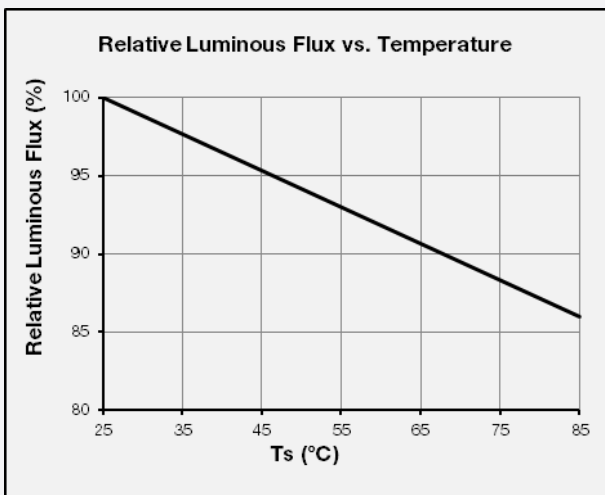

d) Color Shift Characteristics ( $I_f = 60 \text{ mA}$ ,  $T_s = 25 \text{ }^\circ\text{C}$ )

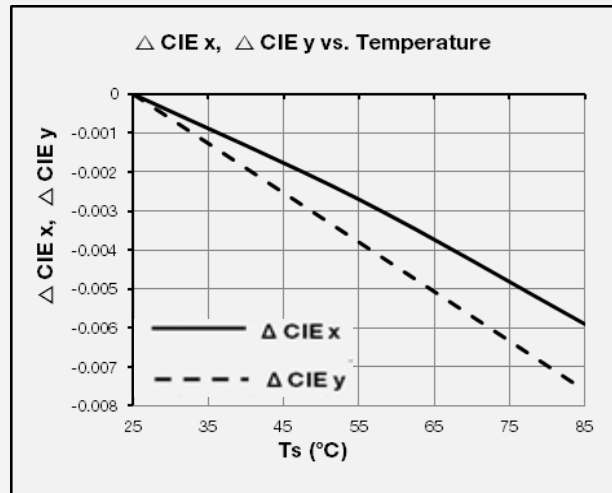
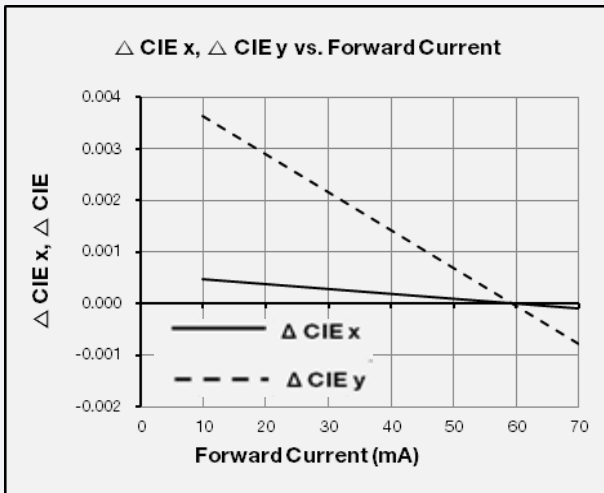

e) Derating Curve

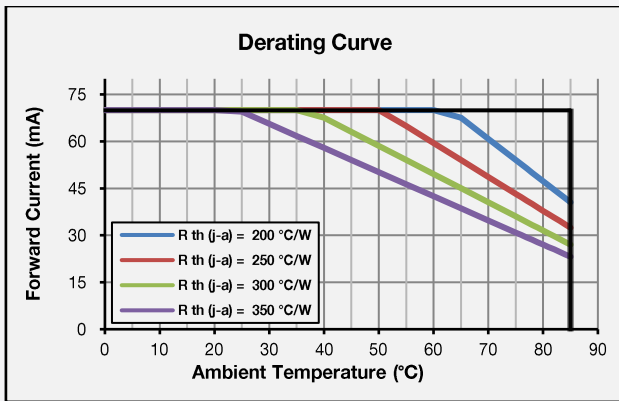

f) Beam Angle Characteristics ( $I_f = 60 \text{ mA}$ ,  $T_s = 25 \text{ }^\circ\text{C}$ )

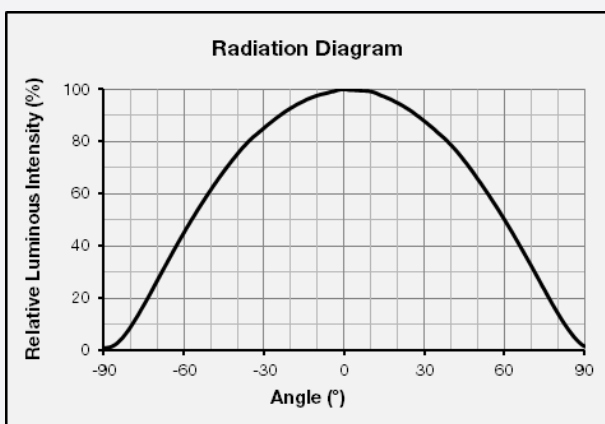

#### 4. Outline Drawing & Dimension

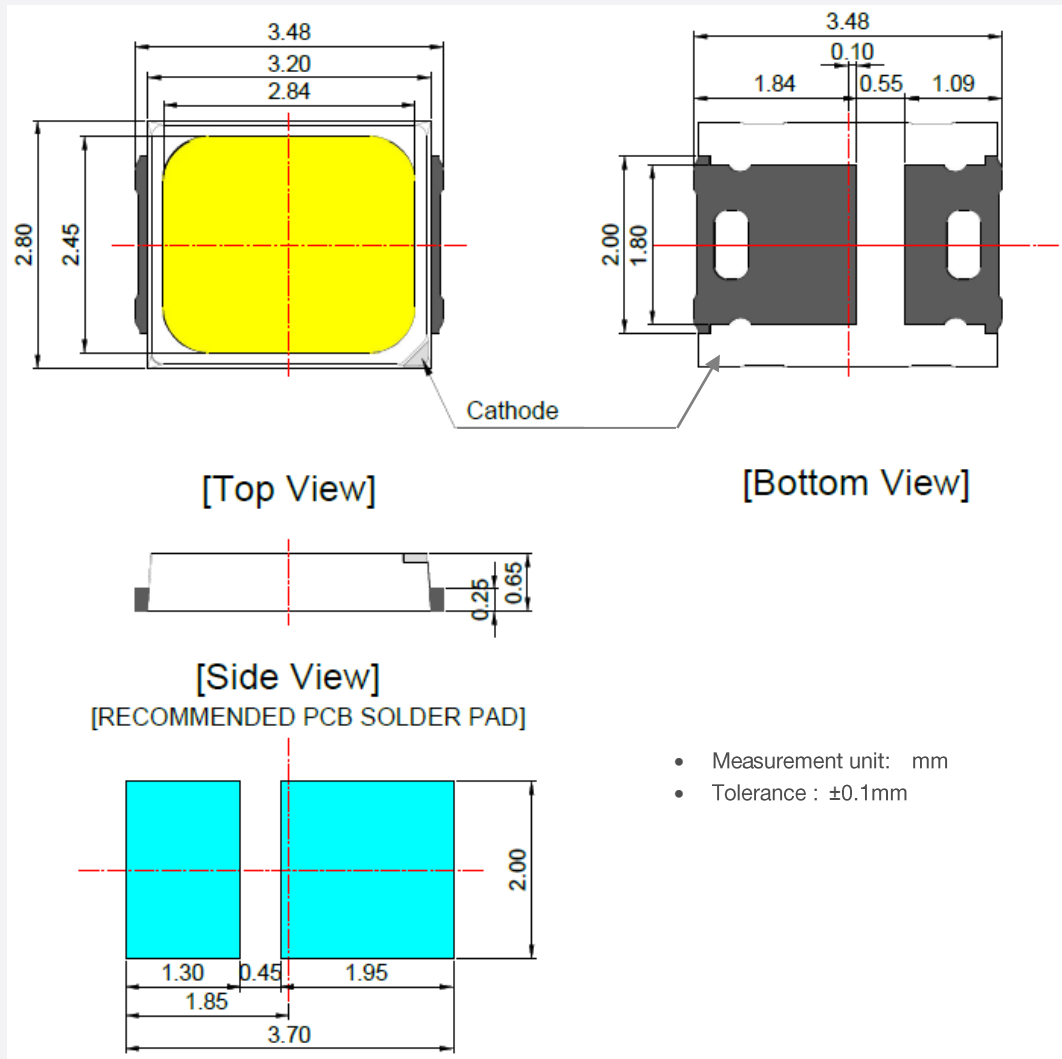

#### Notes:

- 1)  $T_s$  point and measurement method:
  - ① Measure one point at the cathode pad, if necessary remove PSR of PCB to reach  $T_s$  point.
  - ② All pads must be soldered to the PCB to dissipate heat properly, otherwise the LED can be damaged.

#### Precautions:

- 1) Pressure on the LEDs will influence to the reliability of the LEDs. Precautions should be taken to avoid strong pressure on the LEDs. Do not put stress on the LEDs during heating.
- 2) Re-soldering should not be done after the LEDs have been soldered. If re-soldering is unavoidable, LED's characteristics should be carefully checked before and after such repair.
- 3) Do not stack assembled PCBs together. Since materials of LEDs is soft, abrasion between two PCB assembled with LED might cause catastrophic failure of the LEDs.

## 5. Reliability Test Items & Conditions

### a) Test Items

Test Item	Test Condition	Test Hour / Cycle	Sample No.
Room Temperature Life Test	25 °C, DC 70 mA	1000 h	22
High Temperature Life Test	85 °C, DC 70 mA	1000 h	22
High Temperature Humidity Life Test	60 °C, 90 % RH, DC 70 mA	1000 h	22
Low Temperature Life Test	-40 °C, DC 70 mA	1000 h	22
Powered Temperature Cycle Test	-45 °C ~ 85 °C, each 20 min, on/off 5 min Temp. Change time 100min, DC 70 mA	100 cycles	22
Temperature Cycling	-45 °C / 15 min ↔ 125 °C / 15 min	200 cycles	100
High Temperature Storage	85 °C	1000 h	11
Low Temperature Storage	-40 °C	1000 h	11

ESD (HBM)



$R_1$ : 10 M $\Omega$   
 $R_2$ : 1.5 k $\Omega$   
 $C$ : 100 pF  
 $V$ :  $\pm 2$  kV

5 times

30

### b) Criteria for Judging the Damage

Item	Symbol	Test Condition ( $T_s = 25$ °C)	Limit	
			Min	Max
Forward Voltage	$V_F$	$I_F = 60$ mA	Init. Value * 0.9	Init. Value * 1.1
Luminous Flux	$\Phi_v$	$I_F = 60$ mA	Init. Value * 0.7	Init. Value * 1.1

## 6. Soldering Conditions

### a) Reflow Conditions (Pb free)

Reflow frequency: 2 times max.

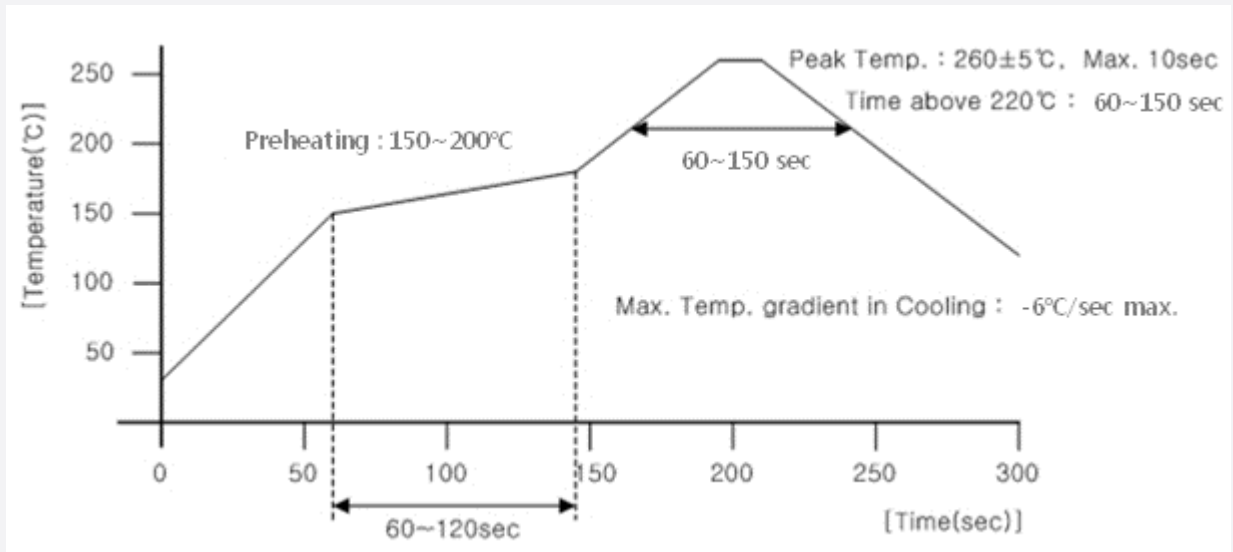

### b) Manual Soldering Conditions

Not more than 5 seconds @ max. 300 °C, under soldering iron.

## 7. Tape & Reel

### a) Taping Dimension

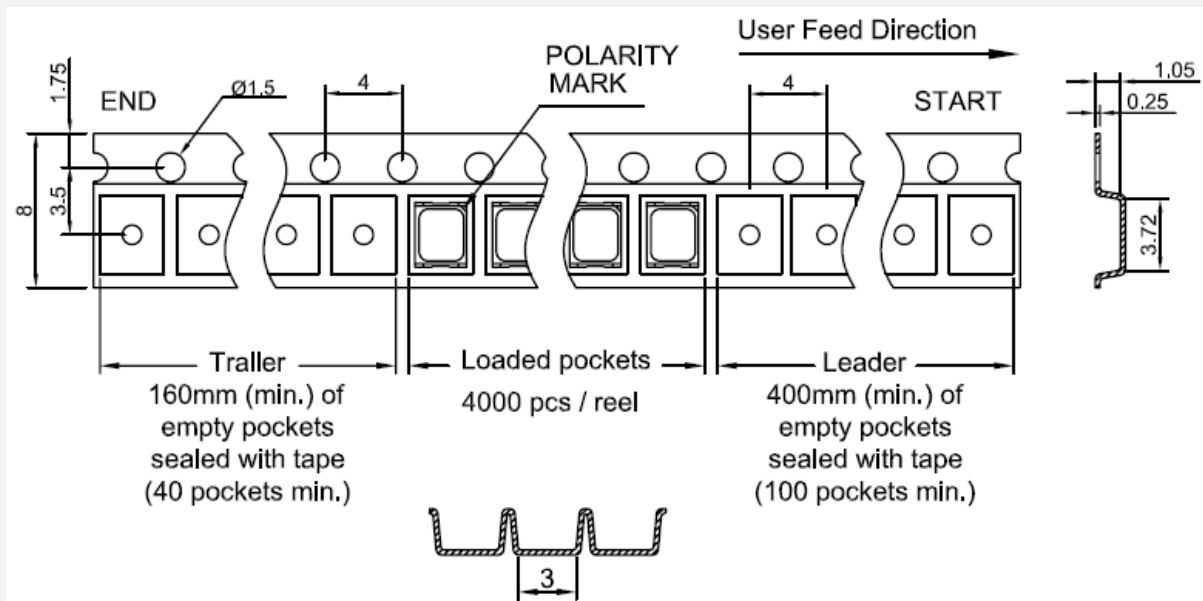

## b) Reel Dimension (max 4,000 pcs)

(unit: mm)

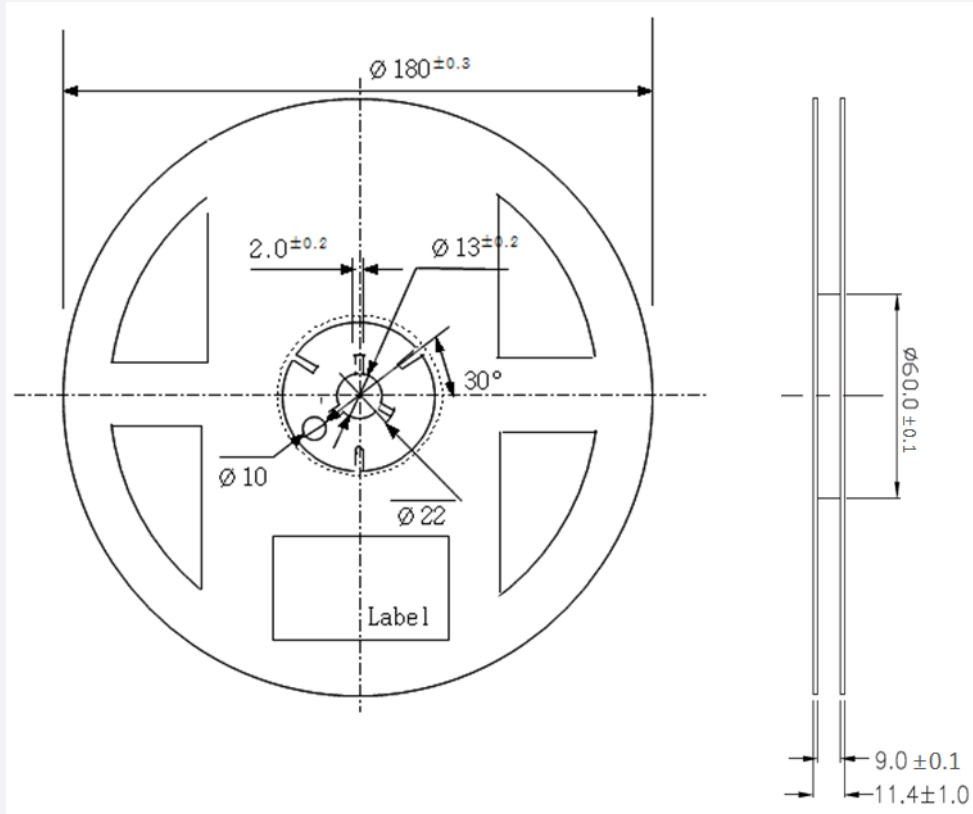
**Notes:**

- 1) Quantity: The quantity/reel is 4,000 pcs
- 2) All dimensions are millimeters (tolerance :  $\pm 0.2$ mm)
- 3) Packaging: P/N, Manufacturing data code no. and quantity are indicated on the aluminum packing bag

c) Reel Dimension (max 16,000 pcs)

(unit: mm)

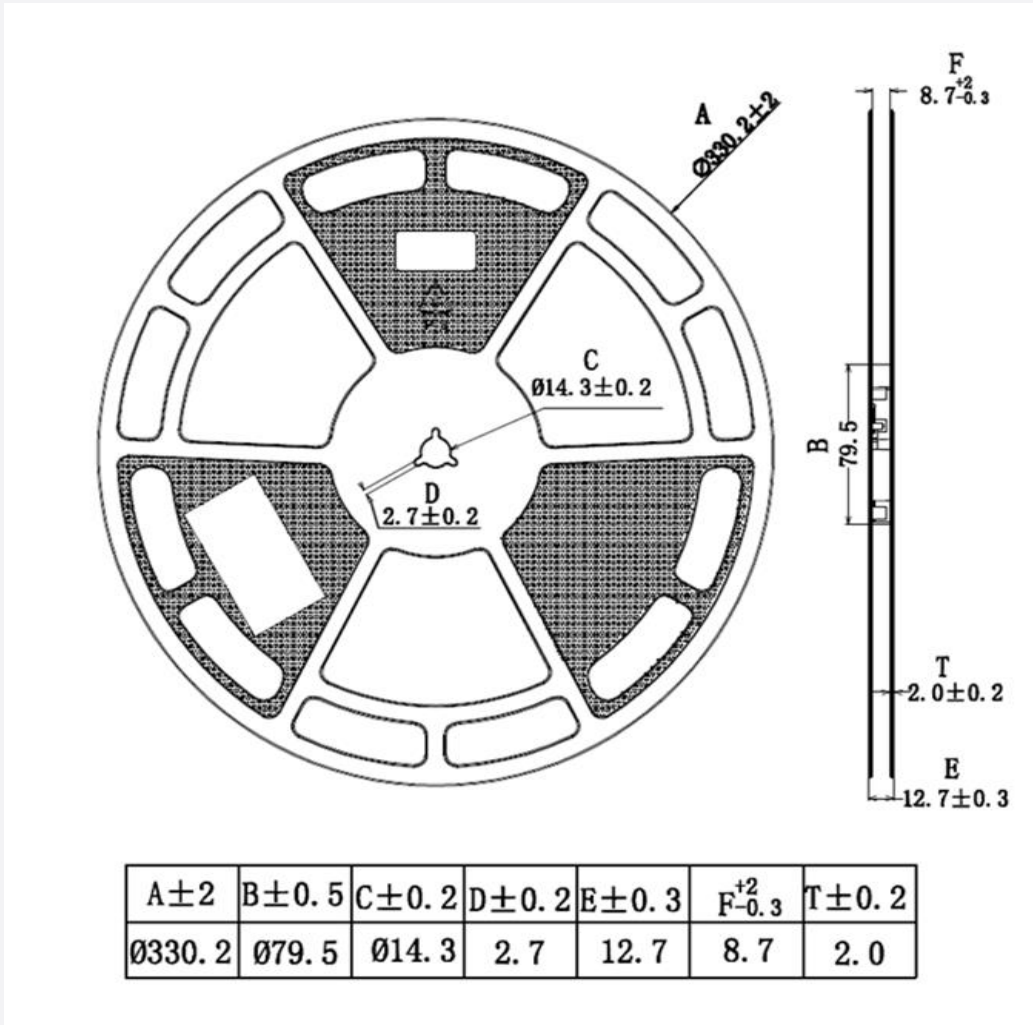

**Notes:**

- 1) Quantity: The quantity/reel is 16,000 pcs
- 2) All dimensions are millimeters (tolerance : ±0.2mm)
- 3) Packaging: P/N, Manufacturing data code no. and quantity are indicated on the aluminum packing bag

## 8. Label Structure

### a) Label Structure

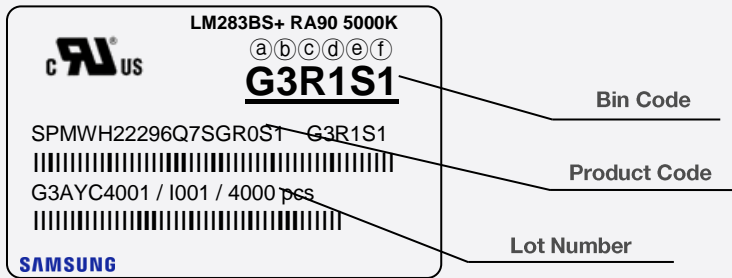

Note: Denoted bin code and product code above is only an example (see description on page 6)

Bin Code:

- ⒶⒷ: Forward Voltage bin (refer to page 10)
- ⒸⒹ: Chromaticity bin (refer to page 11-18)
- ⒺⒻ: Luminous Flux bin (refer to page 7)

### b) Lot Number

The lot number is composed of the following characters:



①②③④⑤⑥⑦⑧⑨ / IⒶⒷⒸ / 4,000 pcs

- ①② : Production site (G3 or GP : Shenzhen, China)
- ③ : Product state (A: Normal, B: Bulk, C: First Production, R: Reproduction, S: Sample)
- ④ : Year (Z: 2015, A: 2016, B: 2017...)
- ⑤ : Month (1~9, A, B, C)
- ⑥ : Day (1~9, A, B~V)
- ⑦⑧⑨ ⒶⒷⒸ : Product serial number

## 9. Packing Structure

### a) Packing Process

#### Reel

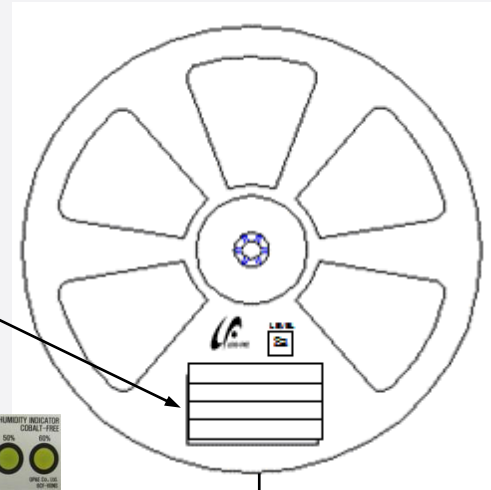
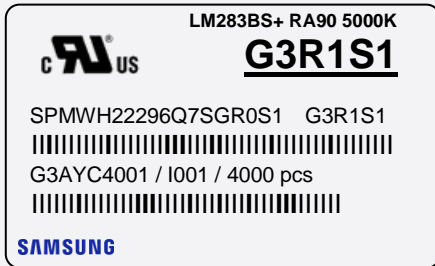

#### Aluminum Vinyl Packing Bag

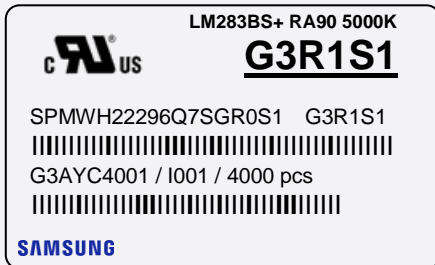

#### Outer Box

Material: Paper (SW3B(B))

Type	Size (mm)			Note
	L	W	H	
7 inch L	245 ± 5	220 ± 5	182 ± 5	Up to 10 reels
7 inch S	245 ± 5	220 ± 5	86 ± 5	Up to 5 reels

#### ① Side Label

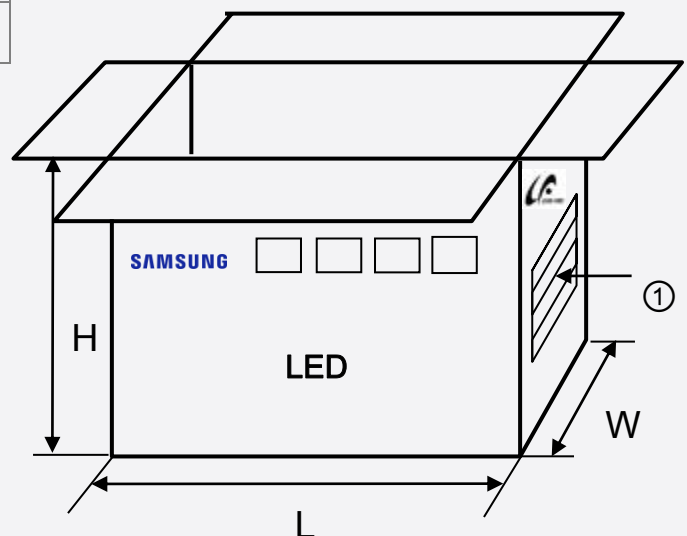
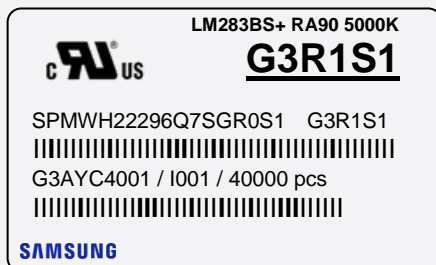

b) Packing Process (The quantity of PKG on the Reel to be Max 16,000 pcs)

Reel

LM283BS+ RA90 5000K  
**G3R1S1**  
 SPMWH22296Q7SKR0S1 G3R1S1  
 G3AYC4001 / IOAA / 16000 pcs  
**SAMSUNG**

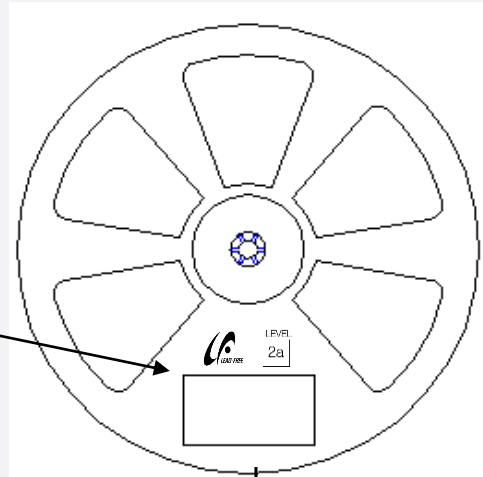

Aluminum Vinyl Packing Bag

LM283BS+ RA90 5000K  
**G3R1S1**  
 SPMWH22296Q7SKR0S1 G3R1S1  
 G3AYC4001 / IOAA / 16000 pcs  
**SAMSUNG**



Outer Box

LM283BS+ RA90 5000K  
**G3R1S1**  
 SPMWH22296Q7SKR0S1 G3R1S1  
 G3AYC4001 / IOAA / 480000 pcs  
**SAMSUNG**

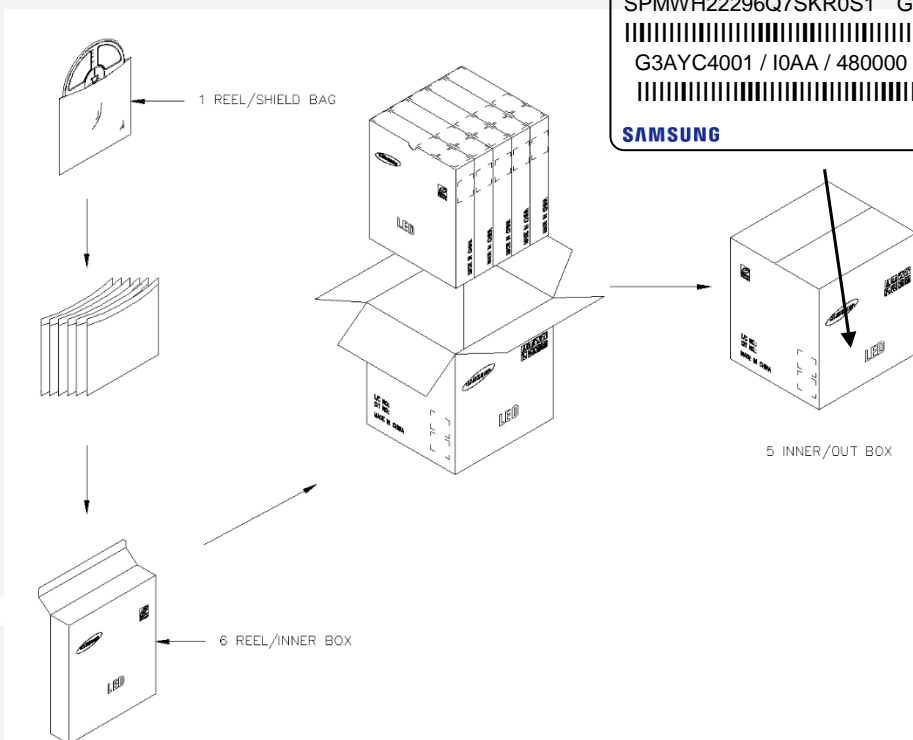

b) Packing Process for kitting

Reel

Kitting 'A'

LM283BS+ RA90 ★K  
**C** **RU** **US** **G3★1S1**  
 SPMWH22296Q7SG★KS1 G3★1S1  
 G3AW94001 / I001 / 4000 pcs  
**SAMSUNG**

Kitting 'B'

LM283BS+ RA90 ★K  
**C** **RU** **US** **G3★CS1**  
 SPMWH22296Q7SG★KS1 G3★CS1  
 G3AW94001 / I001 / 4000 pcs  
**SAMSUNG**

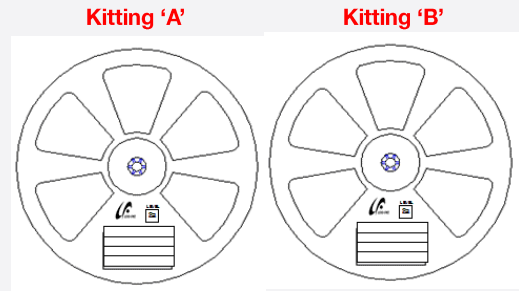

Aluminum Vinyl Packing Bag

Kitting 'A'

LM283BS+ RA90 ★K  
**C** **RU** **US** **G3★1S1**  
 SPMWH22296Q7SG★KS1 G3★1S1  
 G3AW94001 / I001 / 4000 pcs  
**SAMSUNG**

Kitting 'B'

LM283BS+ RA90 ★K  
**C** **RU** **US** **G3★CS1**  
 SPMWH22296Q7SG★KS1 G3★CS1  
 G3AW94001 / I001 / 4000 pcs  
**SAMSUNG**

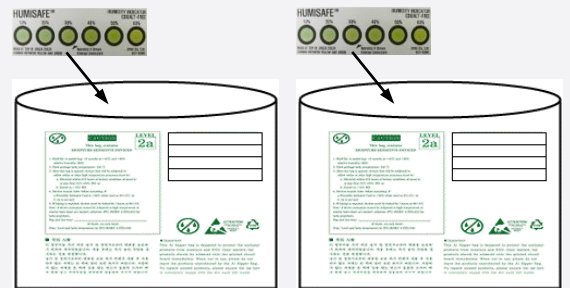

Outer Box

Kitting 'A'

LM283BS+ RA90 ★K  
**C** **RU** **US** **G3★1S1**  
 SPMWH22296Q7SG★KS1 G3★1S1  
 G3AW94001 / I001 / 20000 pcs  
**SAMSUNG** [BOX Label]

Kitting 'B'

LM283BS+ RA90 ★K  
**C** **RU** **US** **G3★CS1**  
 SPMWH22296Q7SG★KS1 G3★CS1  
 G3AW94001 / I001 / 20000 pcs  
**SAMSUNG** [BOX Label]

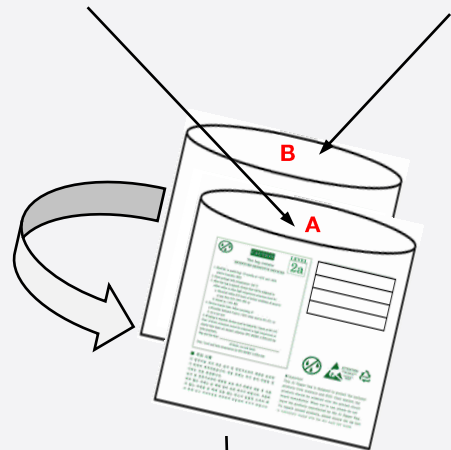

Material: Paper (SW3B(B))

Type	Size (mm)			Note
	L	W	H	
7 inch L	245 ± 5	220 ± 5	182 ± 5	Up to 10 reels

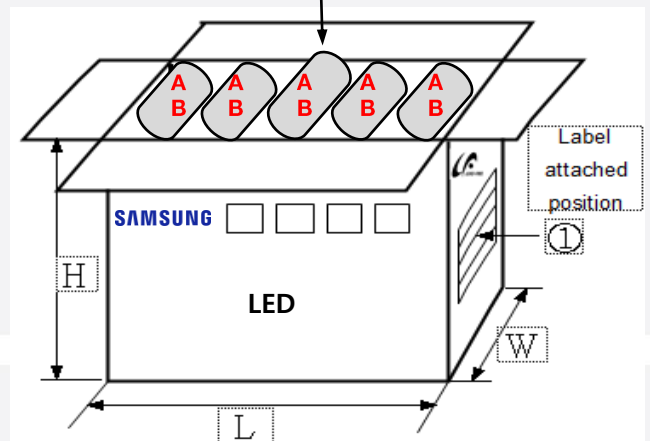

c) Aluminum Vinyl Packing Bag



**CAUTION**

This bag contains  
**MOISTURE SENSITIVE DEVICES**

**LEVEL**

**2a**

1. Shelf life in sealed bag: 12 months at <40°C and <90% relative humidity (RH)
2. Peak package body temperature: 240 °C
3. After this bag is opened, devices that will be subjected to reflow solder or other high temperature processes must be:
  - a. Mounted within 672 hours at factory conditions of equal to or less than 30°C /60% RH, or
  - b. Stored at <10% RH
4. Devices require bake, before mounting, if:
  - a. Humidity Indicator Card is >/60% when read at 23±5°C, or
  - b. 2a is not met.
5. If baking is required, devices must be baked for 10 ~ 24 hours at 60±5°C

Note: If device containers cannot be subjected to high temperature or shorter bake times are desired, reference IPC/JEDEC J-STD-033 for bake procedure,

Bag seal due date: \_\_\_\_\_  
(If blank, see code label)

Note: Level and body temperature by IPC/JEDEC J-STD-020

LM283BS+ RA90 5000K



**G3R1S1**

SPMWH22296Q7SGR0S1 G3R1S1  
 ══  
 G3AYC4001 / I001 / 4,000 pcs  
 ══

SAMSUNG



LEAD-FREE





ATTENTION  
OBSERVE PRECAUTIONS  
FOR HANDLING  
ELECTROSTATIC  
SENSITIVE  
DEVICES



OTHER

**■ 주의 사항**

이 알루미늄 지퍼 백은 습기 및 정전기로부터 제품을 보호하기 위하여 제작되었습니다. 개봉 후에는 즉시 솔더 작업을 실시하는 것을 권장합니다.

습기 및 정전기로부터 제품을 보호 하기 위해서 개봉 후 사용하지 않는 자재는 본 팩에 넣어 보관 하시기 바랍니다. 사용하지 않는 자재를 본 팩에 넣을 때는 반드시 동봉된 드라이 팩과 함께 넣고 지퍼부분을 완전하게 밀봉하여 주시기 바랍니다.

**■ Important**

This Al Zipper bag is designed to protect the enclosed products from moisture and ESD. Once opened, the products should be soldered onto the printed circuit board immediately. When not in use, please do not leave the products unprotected by the Al Zipper Bag. To repack unused products., please ensure the zip-lock is completely sealed with the dry pack left inside.

d) Humidity Indicator Card inside Aluminum Vinyl Bag

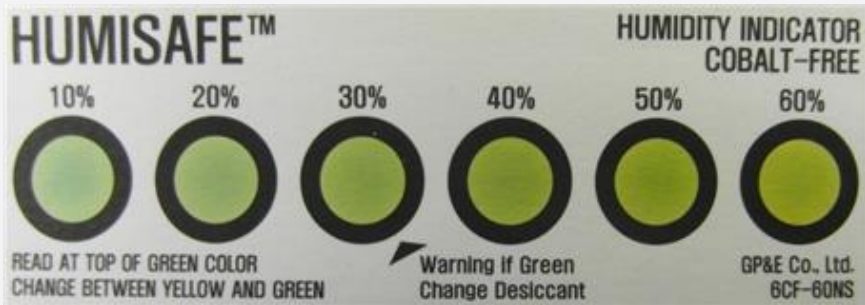

## 10. Precautions in Handling & Use

- 1) For over-current protection, users are recommended to apply resistors connected in series with the LEDs to mitigate sudden change of the forward current caused by shift of forward voltage.
- 2) This device should not be used in any type of fluid such as water, oil, organic solvent, etc. When cleaning is required, IPA is recommended as the cleaning agent. Some solvent-based cleaning agent may damage the silicone resins used in the device.
- 3) When the device is in operation, the forward current should be carefully determined considering the maximum ambient temperature and corresponding junction temperature.
- 4) LEDs must be stored in a clean environment. If the LEDs are to be stored for three months or more after being shipped from Samsung, they should be packed with a nitrogen-filled container (shelf life of sealed bags is 12 months at temperature 0~40 °C, 0~90 % RH).
- 5) After storage bag is opened, device subjected to soldering, solder reflow, or other high temperature processes must be:
  - a. Mounted within 672 hours (28 days) at an assembly line with a condition of no more than 30 °C / 60 % RH<sup>\*Note 1</sup>, or
  - b. Mounted within 24 hours (1 day) at an assembly line with a condition of more than 30 °C / 70 % RH<sup>\*Note 2</sup>, or
  - c. Stored at <10 % RH.

\*Note 1, 2: IPC/JEDEC J-STD-033A, Recommended Equivalent Total Floor Life Table

Package Type and Body Thickness	Moisture Sensitivity Level	Maximum Percent Relative Humidity						Temperature
		40%	50%	60%	70%	80%	90%	
Body Thickness <2.1mm	Level 2a	∞	∞	28	1	1	1	30°C
		∞	∞	∞	2	1	1	25°C
		∞	∞	∞	2	2	1	20°C

- 6) Repack unused devices with anti-moisture packing, fold to close any opening and then store in a dry place.
- 7) Devices require baking before mounting, if humidity card reading is >60 % at 23 ± 5 °C.
- 8) Devices must be baked for 10~24 hours at 60 ± 5 °C, if baking is required.
- 9) The LEDs are sensitive to the static electricity and surge current. It is recommended to use a wrist band or anti-electrostatic glove when handling the LEDs. If voltage exceeding the absolute maximum rating is applied to LEDs, it may cause damage or even destruction to LED devices. Damaged LEDs may show some unusual characteristics such as increase in leakage current, lowered turn-on voltage, or abnormal lighting of LEDs at low current.
- 10) VOCs (Volatile Organic Compounds) can be generated from adhesives, flux, hardener or organic additives used in luminaires (fixtures). Transparent LED silicone encapsulant is permeable to those chemicals and they may lead to a discoloration of encapsulant when they exposed to heat or light. This phenomenon can cause a significant loss of light emitted (output) from the luminaires. In order to prevent these problems, we recommend users to know the physical properties of materials used in luminaires and they must be carefully selected.
- 11) Risk of sulfurization (or tarnishing)
 

The LED from Samsung uses a silver-plated lead frame and its surface color may change to black (or dark colored) when it is exposed to sulfur (S), chlorine (Cl) or other halogen compound. Sulfurization of lead frame may cause intensity degradation, change of chromaticity coordinates and, in extreme cases, open circuit. It requires caution. Due to possible sulfurization of lead frame, LED should not be used and stored together with oxidizing substances made of materials such as rubber, plain paper, lead solder cream, etc.

# Legal and additional information.

## [About Samsung Electronics Co., Ltd.](#)

Samsung inspires the world and shapes the future with transformative ideas and technologies. The company is redefining the worlds of TVs, smartphones, wearable devices, tablets, digital appliances, network systems, and memory, system LSI, foundry and LED solutions. For the latest news, please visit the Samsung Newsroom at [news.samsung.com](http://news.samsung.com).

Copyright © 2018 Samsung Electronics Co., Ltd. All rights reserved.  
Samsung is a registered trademark of Samsung Electronics Co., Ltd.  
Specifications and designs are subject to change without notice. Non-metric weights and measurements are approximate. All data were deemed correct at time of creation. Samsung is not liable for errors or omissions. All brand, product, service names and logos are trademarks and/or registered trademarks of their respective owners and are hereby recognized and acknowledged.

Samsung Electronics Co., Ltd.  
95, Samsung 2-ro  
Giheung-gu  
Yongin-si, Gyeonggi-do, 446-711  
KOREA

[www.samsungled.com](http://www.samsungled.com)

**SAMSUNG**

## Looking for pricing, stock, or lifecycle information?

Click below to explore more details on WIN SOURCE:

- ⊖ [View SPMWH22296Q7SGW0S1](#) on WIN SOURCE
- ⊖ [Samsung](#) Information

## Optimize Your Supply Chain with WIN SOURCE Solutions

- ✓ Global Sourcing Solution
- ✓ Obsolete Management
- ✓ Cost Control Management
- ✓ Shortage Management
- ✓ Alternative Solution
- ✓ Excess Inventory Management