



**THE DATASHEET OF
SPHWAHDNL251ZT3Q6**



[About Samsung Electronics Co., Ltd.](#)

Samsung Electronics Co. Ltd inspires the world and shapes the future with transformative ideas and technologies. The company is redefining the worlds of TVs, smartphones, wearable devices, tablets, digital appliances, network systems, and semiconductor and LED solutions. For the latest news, please visit the Samsung Newsroom at <http://news.samsung.com>.

Copyright 2019 Samsung Electronics Co., Ltd. All rights reserved.
Samsung Electronics reserves the right to modify, at its sole discretion, the design, packaging, specifications, and features shown herein without notice at any time.

Samsung Electronics Co., Ltd.
Samsung-ro 1, Giheung-gu, Yongin-si,
Gyeonggi-do, 17113 Korea

www.samsungled.com



Samsung LED
Retail
Lighting Solutions

Increasing Demand for High Color Quality



Perfect Atmosphere Created by Light

Carefully tuned light intensity and color can influence customers' behavior. It can lead customers to stay longer in the store and eventually result in sales increase



Adam de Guerra_Design Director, Glowing Structure (Light. Space. Design Summit, March 2019 Australia)

Lightings Go Natural

Market demands for more accurate rendering of natural color increased significantly from 4% to 49%



Energy Efficient Light Source

Industry-leading Efficacy

Superior performance based on advanced LED technologies, Samsung COB series provide the industry-leading light efficacy



High Reliability

Metal substrate and small chip structure enable low thermal resistance and high reliability



High Color Quality

High Color Consistency

All COB LEDs are available in 2-step MacAdam ellipse and also 1-step

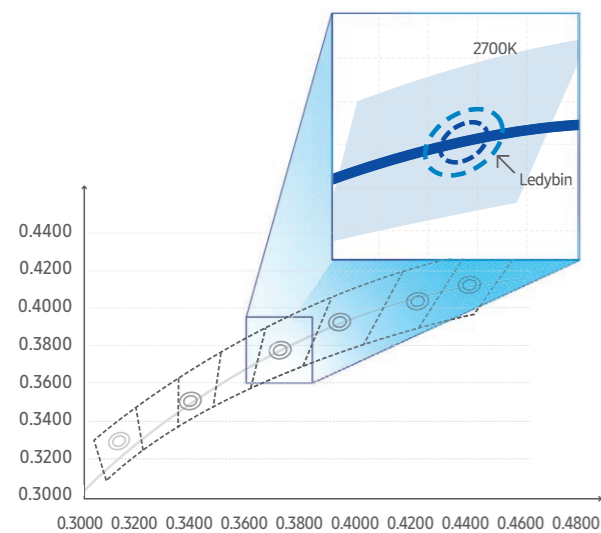

Superior Color Rendering

Ultra High CRI (Ra 95+): Typ. R9 ≈ 90



Advanced Spectrum Engineering

Samsung spectrum engineering creates the special color for retail lighting



One Stop Solution

A wide range of wattage and CRI options

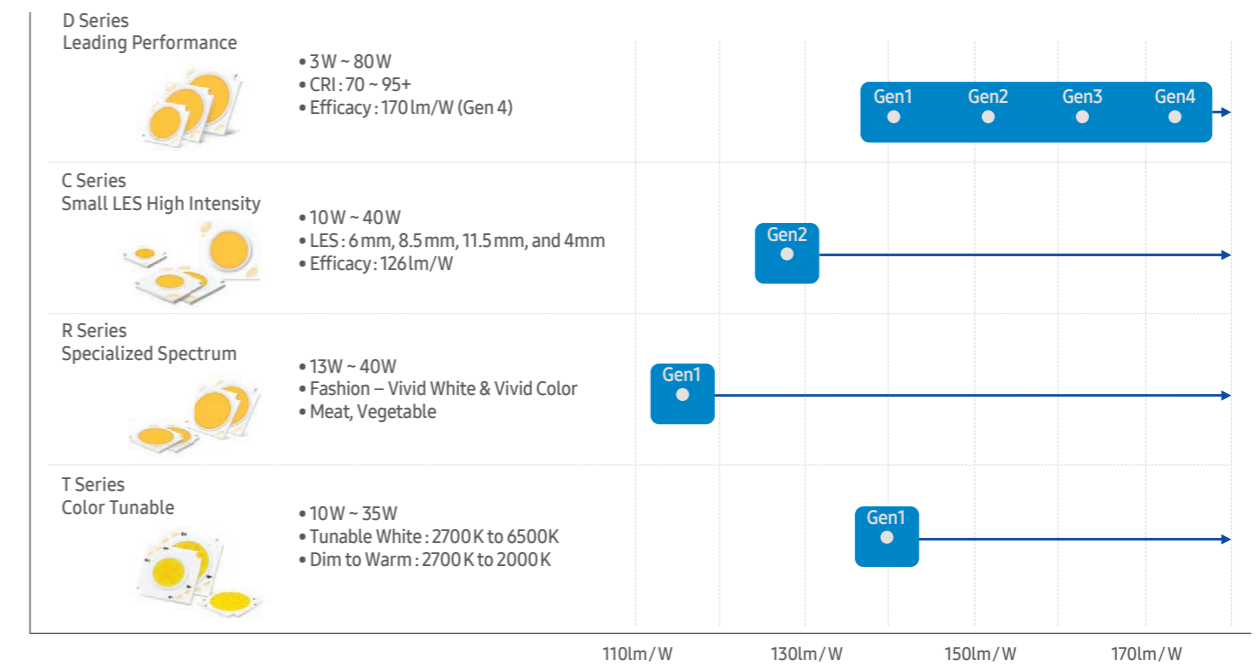

D-Series

Flawless Lighting, Anywhere

Selective quality standards certify superior lights for all applications

D-series with Leading Performance

Industry-leading performance in a wide range of wattage and CRI options

The industry-leading performance



A wide range of wattage and CRI options

| D-series | Model LES | Wattage | | | | | | | | | | |
|---|-----------|---------|----|----|-----|-----|-----|-----|-----|-----|-----|-----|
| | | 3W | 6W | 9W | 13W | 16W | 19W | 26W | 33W | 40W | 60W | 80W |
| Gen 1 D1 rank: 143lm/W D0 rank: 136lm/W | CRI 70+ | | | | | | | | | | ● | ● |
| | CRI 80+ | ● | ● | ● | ● | ● | ● | ● | ● | ● | ● | ● |
| | CRI 90+ | ● | ● | ● | ● | ● | ● | ● | ● | ● | ● | ● |
| Gen 2 D2 rank: 151lm/W | CRI 70+ | | | ● | ● | ● | ● | ● | ● | ● | ● | ● |
| | CRI 80+ | ● | ● | ● | ● | ● | ● | ● | ● | ● | ● | ● |
| | CRI 90+ | ● | ● | ● | ● | ● | ● | ● | ● | ● | ● | ● |
| Gen 3 D3 rank: 161lm/W | CRI 70+ | | | ● | ● | ● | ● | ● | ● | ● | ● | ● |
| | CRI 80+ | ● | ● | ● | ● | ● | ● | ● | ● | ● | ● | ● |
| | CRI 90+ | ● | ● | ● | ● | ● | ● | ● | ● | ● | ● | ● |



D-series Gen 3

| T _j =85°C | LC003D Gen 3 | LC006D Gen 3 | LC009D Gen 3 | LC013D Gen 3 | LC016D Gen 3 | LC019D Gen 3 | LC026D Gen 3 | LC033D Gen 3 | LC040D Gen 3 | LC060D Gen 3 | LC080D Gen 3 | |
|----------------------|-----------------|---------------|---------------|---------------|----------------|----------------|----------------|----------------|-----------------|-----------------|-----------------|-------|
| LES | 9.8mm | | | 14.5mm | | | | 22 mm | | | | |
| Typical | 33.8V | | | | | | | | | | | 50.7V |
| | 3.0W (90mA) | 6.1W (180mA) | 9.1W (270mA) | 12.2W (360mA) | 15.2W (450mA) | 18.3W (540mA) | 24.3W (720mA) | 30.4W (900mA) | 36.5W (1080mA) | 54.8W (1080mA) | 82.1W (1620mA) | |
| Max. | 8.7W (230mA) | 17.4W (460mA) | 26.1W (690mA) | 34.8W (920mA) | 43.5W (1150mA) | 52.2W (1380mA) | 69.6W (1840mA) | 86.9W (2300mA) | 104.3W (2760mA) | 152.9W (2760mA) | 229.3W (4140mA) | |
| Size | 13.5mm x 13.5mm | | | 19mm x 19mm | | | | 28mm x 28mm | | | | |

Color Variation

* CRI: Minimum

| Product | CRI90+ | | | | | CRI80+ | | | | | | | CRI70+ | | |
|----------------|--------|-------|-------|-------|-------|--------|-------|-------|-------|-------|-------|-------|--------|-------|-------|
| | 2700K | 3000K | 3500K | 4000K | 5000K | 2700K | 3000K | 3500K | 4000K | 5000K | 5700K | 6500K | 3000K | 4000K | 5000K |
| LC003D Gen3 | 0 | 0 | 0 | 0 | 0 | 0 | 0 | 0 | 0 | 0 | 0 | 0 | | | |
| LC006D Gen3 | 0 | 0 | 0 | 0 | 0 | 0 | 0 | 0 | 0 | 0 | 0 | 0 | | | |
| LC009D Gen3 | 0 | 0 | 0 | 0 | 0 | 0 | 0 | 0 | 0 | 0 | 0 | 0 | 0 | 0 | 0 |
| LC013D Gen3 | 0 | 0 | 0 | 0 | 0 | 0 | 0 | 0 | 0 | 0 | 0 | 0 | 0 | 0 | 0 |
| LC016D Gen3 | 0 | 0 | 0 | 0 | 0 | 0 | 0 | 0 | 0 | 0 | 0 | 0 | 0 | 0 | 0 |
| LC019D Gen3 | 0 | 0 | 0 | 0 | 0 | 0 | 0 | 0 | 0 | 0 | 0 | 0 | 0 | 0 | 0 |
| LC026D Gen3 | 0 | 0 | 0 | 0 | 0 | 0 | 0 | 0 | 0 | 0 | 0 | 0 | 0 | 0 | 0 |
| LC033D Gen3 | 0 | 0 | 0 | 0 | 0 | 0 | 0 | 0 | 0 | 0 | 0 | 0 | 0 | 0 | 0 |
| LC040D Gen3 | 0 | 0 | 0 | 0 | 0 | 0 | 0 | 0 | 0 | 0 | 0 | 0 | 0 | 0 | 0 |
| LC060D Gen3 | 0 | 0 | 0 | 0 | 0 | 0 | 0 | 0 | 0 | 0 | 0 | 0 | 0 | 0 | 0 |
| LC080D Gen3 | 0 | 0 | 0 | 0 | 0 | 0 | 0 | 0 | 0 | 0 | 0 | 0 | 0 | 0 | 0 |
| MacAdam 2-Step | 0 | 0 | 0 | 0 | | 0 | 0 | 0 | 0 | | | | | | |
| MacAdam 3-Step | 0 | 0 | 0 | 0 | 0 | 0 | 0 | 0 | 0 | 0 | 0 | 0 | 0 | 0 | 0 |

Specifications

| Product | CRI | CCT (K) | Color Rank | Part Number | T _j = 85°C | | I _F (mA) V _F (V) | | |
|---|-------------------|---|-------------------|-------------------|-------------------------|-------------------------------|---|-----|----------------|
| | | | | | Luminous Flux Typ. (lm) | Luminous Efficacy Typ. (lm/W) | | | |
|  LC003D Gen 3 | 80+ | 2700 | MacAdam 2step | SPHWAHDNA25YZW2D3 | 475 | 156 | 90mA 33.8V | | |
| | | | MacAdam 3step | SPHWAHDNA25YZW3D3 | | | | | |
| | | 3000 | MacAdam 2step | SPHWAHDNA25YZV2D3 | 499 | 164 | | | |
| | | | MacAdam 3step | SPHWAHDNA25YZV3D3 | | | | | |
| | | 3500 | MacAdam 2step | SPHWAHDNA25YZU2D3 | 514 | 169 | | | |
| | | | MacAdam 3step | SPHWAHDNA25YZU3D3 | | | | | |
| | | 4000 | MacAdam 2step | SPHWAHDNA25YZT2D3 | 524 | 172 | | | |
| | | | MacAdam 3step | SPHWAHDNA25YZT3D3 | | | | | |
| | | 5000 | MacAdam 3step | SPHWAHDNA25YZR3D3 | 529 | 174 | | | |
| | | 5700 | MacAdam 3step | SPHWAHDNA25YZQ3D3 | 529 | 174 | | | |
| | | 6500 | MacAdam 3step | SPHWAHDNA25YZP3D3 | 524 | 172 | | | |
| | |  LC006D Gen 3 | 90+ | 2700 | MacAdam 2step | SPHWAHDNA27YZW2D3 | | 407 | 134 |
| | | | | | MacAdam 3step | SPHWAHDNA27YZW3D3 | | | |
| | | | | 3000 | MacAdam 2step | SPHWAHDNA27YZV2D3 | | 428 | 141 |
| MacAdam 3step | SPHWAHDNA27YZV3D3 | | | | | | | | |
| 3500 | MacAdam 2step | | | SPHWAHDNA27YZU2D3 | 441 | 145 | | | |
| | MacAdam 3step | | | SPHWAHDNA27YZU3D3 | | | | | |
| 4000 | MacAdam 2step | | | SPHWAHDNA27YZT2D3 | 450 | 148 | | | |
| | MacAdam 3step | | | SPHWAHDNA27YZT3D3 | | | | | |
| 5000 | MacAdam 3step | | | SPHWAHDNA27YZR3D3 | 453 | 149 | | | |
|  LC006D Gen 3 | 80+ | | | 2700 | MacAdam 2step | SPHWAHDNB25YZW2D3 | 946 | 155 | 180mA 33.8V |
| | | MacAdam 3step | SPHWAHDNB25YZW3D3 | | | | | | |
| | | 3000 | MacAdam 2step | SPHWAHDNB25YZV2D3 | 994 | 163 | | | |
| | | | MacAdam 3step | SPHWAHDNB25YZV3D3 | | | | | |
| | | 3500 | MacAdam 2step | SPHWAHDNB25YZU2D3 | 1023 | 168 | | | |
| | | | MacAdam 3step | SPHWAHDNB25YZU3D3 | | | | | |
| | | 4000 | MacAdam 2step | SPHWAHDNB25YZT2D3 | 1043 | 171 | | | |
| | | | MacAdam 3step | SPHWAHDNB25YZT3D3 | | | | | |
| | | 5000 | MacAdam 3step | SPHWAHDNB25YZR3D3 | 1052 | 173 | | | |
| | | 5700 | MacAdam 3step | SPHWAHDNB25YZQ3D3 | 1052 | 173 | | | |
| | | 6500 | MacAdam 3step | SPHWAHDNB25YZP3D3 | 1043 | 171 | | | |
| | |  LC006D Gen 3 | 90+ | 2700 | MacAdam 2step | SPHWAHDNB27YZW2D3 | 809 | 133 | |
| | | | | | MacAdam 3step | SPHWAHDNB27YZW3D3 | | | |
| | | | | 3000 | MacAdam 2step | SPHWAHDNB27YZV2D3 | 851 | 140 | |
| MacAdam 3step | SPHWAHDNB27YZV3D3 | | | | | | | | |
| 3500 | MacAdam 2step | | | SPHWAHDNB27YZU2D3 | 877 | 144 | | | |
| | MacAdam 3step | | | SPHWAHDNB27YZU3D3 | | | | | |
| 4000 | MacAdam 2step | | | SPHWAHDNB27YZT2D3 | 895 | 147 | | | |
| | MacAdam 3step | | | SPHWAHDNB27YZT3D3 | | | | | |
| 5000 | MacAdam 3step | SPHWAHDNB27YZR3D3 | 902 | 148 | | | | | |

Specifications

D-series



| Product | CRI | CCT (K) | Color Rank | Part Number | T _j = 85°C | | I _F (mA) V _F (V) |
|---|------|---------------|-------------------|-------------------|-------------------------|-------------------------------|---|
| | | | | | Luminous Flux Typ. (lm) | Luminous Efficacy Typ. (lm/W) | |
|  LC009D Gen 3 | 70+ | 3000 | MacAdam 3step | SPHWAHDNC23YZV3D3 | 1594 | 174 | 270mA 33.8V |
| | | 4000 | MacAdam 3step | SPHWAHDNC23YT3D3 | 1624 | 177 | |
| | | 5000 | MacAdam 3step | SPHWAHDNC23YZR3D3 | 1653 | 180 | |
| | 80+ | 2700 | MacAdam 2step | SPHWAHDNC25YZW2D3 | 1405 | 154 | |
| | | | MacAdam 3step | SPHWAHDNC25YZW3D3 | | | |
| | | 3000 | MacAdam 2step | SPHWAHDNC25YZV2D3 | 1476 | 162 | |
| | | | MacAdam 3step | SPHWAHDNC25YZV3D3 | | | |
| | | 3500 | MacAdam 2step | SPHWAHDNC25YZU2D3 | 1519 | 166 | |
| | | | MacAdam 3step | SPHWAHDNC25YZU3D3 | | | |
| | | 4000 | MacAdam 2step | SPHWAHDNC25YT2D3 | 1550 | 170 | |
| | | | MacAdam 3step | SPHWAHDNC25YT3D3 | | | |
| | | 5000 | MacAdam 3step | SPHWAHDNC25YZR3D3 | 1563 | 171 | |
| | 5700 | | MacAdam 3step | SPHWAHDNC25YZQ3D3 | 1563 | 171 | |
| | 6500 | MacAdam 3step | SPHWAHDNC25YZP3D3 | 1550 | 170 | | |
| | 90+ | 2700 | MacAdam 2step | SPHWAHDNC27YZW2D3 | 1202 | 132 | |
| | | | MacAdam 3step | SPHWAHDNC27YZW3D3 | | | |
| | | 3000 | MacAdam 2step | SPHWAHDNC27YZV2D3 | 1264 | 139 | |
| | | | MacAdam 3step | SPHWAHDNC27YZV3D3 | | | |
| 3500 | | MacAdam 2step | SPHWAHDNC27YZU2D3 | 1302 | 143 | | |
| | | MacAdam 3step | SPHWAHDNC27YZU3D3 | | | | |
| 4000 | | MacAdam 2step | SPHWAHDNC27YT2D3 | 1329 | 146 | | |
| | | MacAdam 3step | SPHWAHDNC27YT3D3 | | | | |
| 5000 | | MacAdam 3step | SPHWAHDNC27YZR3D3 | 1340 | 147 | | |
| 70+ | 3000 | MacAdam 3step | SPHWAHDND23YZV3D3 | 2094 | 171 | 360mA 33.8V | |
| | | 4000 | MacAdam 3step | SPHWAHDND23YT3D3 | 2133 | | 174 |
| | | 5000 | MacAdam 3step | SPHWAHDND23YZR3D3 | 2171 | | 177 |
| | 80+ | 2700 | MacAdam 2step | SPHWAHDND25YZW2D3 | 1845 | | 152 |
| | | | MacAdam 3step | SPHWAHDND25YZW3D3 | | | |
| | | 3000 | MacAdam 2step | SPHWAHDND25YZV2D3 | 1939 | | 159 |
| | | | MacAdam 3step | SPHWAHDND25YZV3D3 | | | |
| | | 3500 | MacAdam 2step | SPHWAHDND25YZU2D3 | 1996 | | 164 |
| | | | MacAdam 3step | SPHWAHDND25YZU3D3 | | | |
| | | 4000 | MacAdam 2step | SPHWAHDND25YT2D3 | 2036 | | 167 |
| | | | MacAdam 3step | SPHWAHDND25YT3D3 | | | |
| | | 5000 | MacAdam 3step | SPHWAHDND25YZR3D3 | 2053 | | 169 |
| | 5700 | MacAdam 3step | SPHWAHDND25YZQ3D3 | 2053 | 169 | | |
| | 6500 | MacAdam 3step | SPHWAHDND25YZP3D3 | 2036 | 167 | | |
| | 90+ | 2700 | MacAdam 2step | SPHWAHDND27YZW2D3 | 1579 | | 130 |
| | | | MacAdam 3step | SPHWAHDND27YZW3D3 | | | |
| | | 3000 | MacAdam 2step | SPHWAHDND27YZV2D3 | 1661 | | 137 |
| | | | MacAdam 3step | SPHWAHDND27YZV3D3 | | | |
| 3500 | | MacAdam 2step | SPHWAHDND27YZU2D3 | 1710 | 141 | | |
| | | MacAdam 3step | SPHWAHDND27YZU3D3 | | | | |
| 4000 | | MacAdam 2step | SPHWAHDND27YT2D3 | 1745 | 143 | | |
| | | MacAdam 3step | SPHWAHDND27YT3D3 | | | | |
| 5000 | | MacAdam 3step | SPHWAHDND27YZR3D3 | 1760 | 145 | | |

| Product | CRI | CCT (K) | Color Rank | Part Number | T _j = 85°C | | I _F (mA) V _F (V) |
|---|------|---------------|-------------------|-------------------|-------------------------|-------------------------------|---|
| | | | | | Luminous Flux Typ. (lm) | Luminous Efficacy Typ. (lm/W) | |
|  LC016D Gen 3 | 70+ | 3000 | MacAdam 3step | SPHWAHDNE23YZV3D3 | 2697 | 176 | 450mA 33.8V |
| | | 4000 | MacAdam 3step | SPHWAHDNE23YT3D3 | 2747 | 180 | |
| | | 5000 | MacAdam 3step | SPHWAHDNE23YZR3D3 | 2797 | 183 | |
| | 80+ | 2700 | MacAdam 2step | SPHWAHDNE25YZW2D3 | 2376 | 156 | |
| | | | MacAdam 3step | SPHWAHDNE25YZW3D3 | | | |
| | | 3000 | MacAdam 2step | SPHWAHDNE25YZV2D3 | 2497 | 164 | |
| | | | MacAdam 3step | SPHWAHDNE25YZV3D3 | | | |
| | | 3500 | MacAdam 2step | SPHWAHDNE25YZU2D3 | 2570 | 169 | |
| | | | MacAdam 3step | SPHWAHDNE25YZU3D3 | | | |
| | | 4000 | MacAdam 2step | SPHWAHDNE25YT2D3 | 2622 | 172 | |
| | | | MacAdam 3step | SPHWAHDNE25YT3D3 | | | |
| | | 5000 | MacAdam 3step | SPHWAHDNE25YZR3D3 | 2644 | 174 | |
| | 5700 | MacAdam 3step | SPHWAHDNE25YZQ3D3 | 2644 | 174 | | |
| | 6500 | MacAdam 3step | SPHWAHDNE25YZP3D3 | 2622 | 172 | | |
| | 90+ | 2700 | MacAdam 2step | SPHWAHDNE27YZW2D3 | 2033 | 134 | |
| | | | MacAdam 3step | SPHWAHDNE27YZW3D3 | | | |
| | | 3000 | MacAdam 2step | SPHWAHDNE27YZV2D3 | 2139 | 141 | |
| | | | MacAdam 3step | SPHWAHDNE27YZV3D3 | | | |
| 3500 | | MacAdam 2step | SPHWAHDNE27YZU2D3 | 2203 | 145 | | |
| | | MacAdam 3step | SPHWAHDNE27YZU3D3 | | | | |
| 4000 | | MacAdam 2step | SPHWAHDNE27YT2D3 | 2248 | 148 | | |
| | | MacAdam 3step | SPHWAHDNE27YT3D3 | | | | |
| 5000 | | MacAdam 3step | SPHWAHDNE27YZR3D3 | 2267 | 149 | | |
| 70+ | 3000 | MacAdam 3step | SPHWAHDNF23YZV3D3 | 3220 | 175 | 540mA 33.8V | |
| | | 4000 | MacAdam 3step | SPHWAHDNF23YT3D3 | 3280 | | 179 |
| | | 5000 | MacAdam 3step | SPHWAHDNF23YZR3D3 | 3339 | | 182 |
| | 80+ | 2700 | MacAdam 2step | SPHWAHDNF25YZW2D3 | 2837 | | 155 |
| | | | MacAdam 3step | SPHWAHDNF25YZW3D3 | | | |
| | | 3000 | MacAdam 2step | SPHWAHDNF25YZV2D3 | 2982 | | 163 |
| | | | MacAdam 3step | SPHWAHDNF25YZV3D3 | | | |
| | | 3500 | MacAdam 2step | SPHWAHDNF25YZU2D3 | 3069 | | 168 |
| | | | MacAdam 3step | SPHWAHDNF25YZU3D3 | | | |
| | | 4000 | MacAdam 2step | SPHWAHDNF25YT2D3 | 3130 | | 171 |
| | | | MacAdam 3step | SPHWAHDNF25YT3D3 | | | |
| | | 5000 | MacAdam 3step | SPHWAHDNF25YZR3D3 | 3157 | | 173 |
| | 5700 | MacAdam 3step | SPHWAHDNF25YZQ3D3 | 3157 | 173 | | |
| | 6500 | MacAdam 3step | SPHWAHDNF25YZP3D3 | 3130 | 171 | | |
| | 90+ | 2700 | MacAdam 2step | SPHWAHDNF27YZW2D3 | 2428 | | 133 |
| | | | MacAdam 3step | SPHWAHDNF27YZW3D3 | | | |
| | | 3000 | MacAdam 2step | SPHWAHDNF27YZV2D3 | 2554 | | 140 |
| | | | MacAdam 3step | SPHWAHDNF27YZV3D3 | | | |
| 3500 | | MacAdam 2step | SPHWAHDNF27YZU2D3 | 2630 | 144 | | |
| | | MacAdam 3step | SPHWAHDNF27YZU3D3 | | | | |
| 4000 | | MacAdam 2step | SPHWAHDNF27YT2D3 | 2684 | 147 | | |
| | | MacAdam 3step | SPHWAHDNF27YT3D3 | | | | |
| 5000 | | MacAdam 3step | SPHWAHDNF27YZR3D3 | 2707 | 148 | | |

D-series

Specifications

D-series

| Product | CRI | CCT (K) | Color Rank | Part Number | T _j = 85°C | | I _F (mA) V _F (V) |
|---|---------------|-------------------|-------------------|-------------------|-------------------------|-------------------------------|---|
| | | | | | Luminous Flux Typ. (lm) | Luminous Efficacy Typ. (lm/W) | |
|  LC026D Gen 3 | 70+ | 3000 | MacAdam 3step | SPHWAHDNG23YZV3D3 | 4230 | 174 | 720mA 33.8V |
| | | 4000 | MacAdam 3step | SPHWAHDNG23YZT3D3 | 4308 | 177 | |
| | | 5000 | MacAdam 3step | SPHWAHDNG23YZR3D3 | 4387 | 180 | |
| | 80+ | 2700 | MacAdam 2step | SPHWAHDNG25YZW2D3 | 3727 | 153 | |
| | | | MacAdam 3step | SPHWAHDNG25YZW3D3 | | | |
| | | 3000 | MacAdam 2step | SPHWAHDNG25YZV2D3 | 3917 | 161 | |
| | | | MacAdam 3step | SPHWAHDNG25YZV3D3 | | | |
| | | 3500 | MacAdam 2step | SPHWAHDNG25YZU2D3 | 4032 | 166 | |
| | | | MacAdam 3step | SPHWAHDNG25YZU3D3 | | | |
| | 4000 | MacAdam 2step | SPHWAHDNG25YZT2D3 | 4112 | 169 | | |
| | | MacAdam 3step | SPHWAHDNG25YZT3D3 | | | | |
| | 90+ | 5000 | MacAdam 3step | SPHWAHDNG25YZR3D3 | 4147 | 170 | |
| | | | MacAdam 3step | SPHWAHDNG25YZQ3D3 | | | |
| | | 6500 | MacAdam 3step | SPHWAHDNG25YZP3D3 | 4112 | 169 | |
| | | | MacAdam 3step | SPHWAHDNG27YZW2D3 | | | |
| | | 2700 | MacAdam 3step | SPHWAHDNG27YZW3D3 | 3190 | 131 | |
| | | | MacAdam 3step | SPHWAHDNG27YZV2D3 | | | |
| | | 3000 | MacAdam 2step | SPHWAHDNG27YZV3D3 | 3355 | 138 | |
| | | | MacAdam 3step | SPHWAHDNG27YZV3D3 | | | |
| | 3500 | MacAdam 2step | SPHWAHDNG27YZU2D3 | 3455 | 142 | | |
| MacAdam 3step | | SPHWAHDNG27YZU3D3 | | | | | |
| 4000 | MacAdam 2step | SPHWAHDNG27YZT2D3 | 3526 | 145 | | | |
| | MacAdam 3step | SPHWAHDNG27YZT3D3 | | | | | |
| 5000 | MacAdam 3step | SPHWAHDNG27YZR3D3 | 3556 | 146 | | | |
| | MacAdam 3step | SPHWAHDNG27YZR3D3 | | | | | |
|  LC033D Gen 3 | 70+ | 3000 | MacAdam 3step | SPHWAHDNH23YZV3D3 | 5235 | 172 | 900mA 33.8V |
| | | 4000 | MacAdam 3step | SPHWAHDNH23YZT3D3 | 5332 | 175 | |
| | | 5000 | MacAdam 3step | SPHWAHDNH23YZR3D3 | 5429 | 178 | |
| | 80+ | 2700 | MacAdam 2step | SPHWAHDNH25YZW2D3 | 4612 | 152 | |
| | | | MacAdam 3step | SPHWAHDNH25YZW3D3 | | | |
| | | 3000 | MacAdam 2step | SPHWAHDNH25YZV2D3 | 4847 | 159 | |
| | | | MacAdam 3step | SPHWAHDNH25YZV3D3 | | | |
| | | 3500 | MacAdam 2step | SPHWAHDNH25YZU2D3 | 4989 | 164 | |
| | | | MacAdam 3step | SPHWAHDNH25YZU3D3 | | | |
| | | 4000 | MacAdam 2step | SPHWAHDNH25YZT2D3 | 5089 | 167 | |
| | | | MacAdam 3step | SPHWAHDNH25YZT3D3 | | | |
| | | 5000 | MacAdam 3step | SPHWAHDNH25YZR3D3 | 5132 | 169 | |
| | | | MacAdam 3step | SPHWAHDNH25YZQ3D3 | | | |
| | | 6500 | MacAdam 3step | SPHWAHDNH25YZP3D3 | 5089 | 167 | |
| | | | MacAdam 3step | SPHWAHDNH25YZP3D3 | | | |

| Product | CRI | CCT (K) | Color Rank | Part Number | T _j = 85°C | | I _F (mA) V _F (V) |
|---|---------------|-------------------|-------------------|-------------------|-------------------------|-------------------------------|---|
| | | | | | Luminous Flux Typ. (lm) | Luminous Efficacy Typ. (lm/W) | |
|  LC033D Gen 3 | 90+ | 2700 | MacAdam 2step | SPHWAHDNH27YZW2D3 | 3947 | 130 | 900mA 33.8V |
| | | | MacAdam 3step | SPHWAHDNH27YZW3D3 | | | |
| | | 3000 | MacAdam 2step | SPHWAHDNH27YZV2D3 | 4152 | 136 | |
| | | | MacAdam 3step | SPHWAHDNH27YZV3D3 | | | |
| | | 3500 | MacAdam 2step | SPHWAHDNH27YZU2D3 | 4276 | 141 | |
| | | | MacAdam 3step | SPHWAHDNH27YZU3D3 | | | |
| | 4000 | MacAdam 2step | SPHWAHDNH27YZT2D3 | 4364 | 143 | | |
| | | MacAdam 3step | SPHWAHDNH27YZT3D3 | | | | |
| | 5000 | MacAdam 3step | SPHWAHDNH27YZR3D3 | 4401 | 145 | | |
| | | MacAdam 3step | SPHWAHDNH27YZR3D3 | | | | |
| | 70+ | 3000 | MacAdam 3step | SPHWAHDNK23YZV3D3 | 6440 | 176 | |
| | | | MacAdam 3step | SPHWAHDNK23YZT3D3 | | | |
| MacAdam 3step | | | SPHWAHDNK23YZR3D3 | | | | |
| 80+ | | 2700 | MacAdam 2step | SPHWAHDNK25YZW2D3 | 5675 | 155 | |
| | | | MacAdam 3step | SPHWAHDNK25YZW3D3 | | | |
| | | 3000 | MacAdam 2step | SPHWAHDNK25YZV2D3 | 5963 | 163 | |
| | | | MacAdam 3step | SPHWAHDNK25YZV3D3 | | | |
| | | 3500 | MacAdam 2step | SPHWAHDNK25YZU2D3 | 6138 | 168 | |
| | | | MacAdam 3step | SPHWAHDNK25YZU3D3 | | | |
| 4000 | MacAdam 2step | SPHWAHDNK25YZT2D3 | 6261 | 172 | | | |
| | MacAdam 3step | SPHWAHDNK25YZT3D3 | | | | | |
| 5000 | MacAdam 3step | SPHWAHDNK25YZR3D3 | 6313 | 173 | | | |
| | MacAdam 3step | SPHWAHDNK25YZQ3D3 | | | | | |
| | MacAdam 3step | SPHWAHDNK25YZP3D3 | | | | | |
| 90+ | 2700 | MacAdam 2step | SPHWAHDNK27YZW2D3 | 4856 | 133 | | |
| | | MacAdam 3step | SPHWAHDNK27YZW3D3 | | | | |
| | 3000 | MacAdam 2step | SPHWAHDNK27YZV2D3 | 5108 | 140 | | |
| | | MacAdam 3step | SPHWAHDNK27YZV3D3 | | | | |
| | 3500 | MacAdam 2step | SPHWAHDNK27YZU2D3 | 5260 | 144 | | |
| | | MacAdam 3step | SPHWAHDNK27YZU3D3 | | | | |
| | 4000 | MacAdam 2step | SPHWAHDNK27YZT2D3 | 5369 | 147 | | |
| | | MacAdam 3step | SPHWAHDNK27YZT3D3 | | | | |
| | 5000 | MacAdam 3step | SPHWAHDNK27YZR3D3 | 5415 | 148 | | |
| | | MacAdam 3step | SPHWAHDNK27YZR3D3 | | | | |

D-series

Specifications

D-series

| Product | CRI | CCT (K) | Color Rank | Part Number | T _j = 85°C | | I _f (mA) V _F (V) |
|--|---------------|---------|-------------------|-------------------|-------------------------|-------------------------------|---|
| | | | | | Luminous Flux Typ. (lm) | Luminous Efficacy Typ. (lm/W) | |
|  LC060D Gen 3 | 70+ | 3000 | MacAdam 3step | SPHWAHDNL231ZV3D3 | 9518 | 174 | 1080mA 50.7V |
| | | 4000 | MacAdam 3step | SPHWAHDNL231ZT3D3 | 9694 | 177 | |
| | | 5000 | MacAdam 3step | SPHWAHDNL231ZR3D3 | 9870 | 180 | |
| | 80+ | 2700 | MacAdam 2step | SPHWAHDNL251ZW2D3 | 8386 | 153 | |
| | | | MacAdam 3step | SPHWAHDNL251ZW3D3 | | | |
| | | 3000 | MacAdam 2step | SPHWAHDNL251ZV2D3 | 8813 | 161 | |
| | | | MacAdam 3step | SPHWAHDNL251ZV3D3 | | | |
| | | 3500 | MacAdam 2step | SPHWAHDNL251ZU2D3 | 9071 | 166 | |
| | | | MacAdam 3step | SPHWAHDNL251ZU3D3 | | | |
| | | 4000 | MacAdam 2step | SPHWAHDNL251ZT2D3 | 9253 | 169 | |
| | | | MacAdam 3step | SPHWAHDNL251ZT3D3 | | | |
| | | 5000 | MacAdam 3step | SPHWAHDNL251ZR3D3 | 9330 | 170 | |
| | | 5700 | MacAdam 3step | SPHWAHDNL251ZQ3D3 | 9330 | 170 | |
| | | 6500 | MacAdam 3step | SPHWAHDNL251ZP3D3 | 9253 | 169 | |
| | | 90+ | 2700 | MacAdam 2step | SPHWAHDNL271ZW2D3 | 7177 | |
| | MacAdam 3step | | | SPHWAHDNL271ZW3D3 | | | |
| | 3000 | | MacAdam 2step | SPHWAHDNL271ZV2D3 | 7549 | 138 | |
| | | | MacAdam 3step | SPHWAHDNL271ZV3D3 | | | |
| | 3500 | | MacAdam 2step | SPHWAHDNL271ZU2D3 | 7774 | 142 | |
| | | | MacAdam 3step | SPHWAHDNL271ZU3D3 | | | |
| | 4000 | | MacAdam 2step | SPHWAHDNL271ZT2D3 | 7934 | 145 | |
| MacAdam 3step | | | SPHWAHDNL271ZT3D3 | | | | |
| 5000 | MacAdam 3step | | SPHWAHDNL271ZR3D3 | 8002 | 146 | | |

| Product | CRI | CCT (K) | Color Rank | Part Number | T _j = 85°C | | I _f (mA) V _F (V) |
|--|---------------|---------|-------------------|-------------------|-------------------------|-------------------------------|---|
| | | | | | Luminous Flux Typ. (lm) | Luminous Efficacy Typ. (lm/W) | |
|  LC080D Gen 3 | 70+ | 3000 | MacAdam 3step | SPHWAHDNM231ZV3D3 | 14115 | 172 | 1620mA 50.7V |
| | | 4000 | MacAdam 3step | SPHWAHDNM231ZT3D3 | 14376 | 175 | |
| | | 5000 | MacAdam 3step | SPHWAHDNM231ZR3D3 | 14637 | 178 | |
| | 80+ | 2700 | MacAdam 2step | SPHWAHDNM251ZW2D3 | 12437 | 151 | |
| | | | MacAdam 3step | SPHWAHDNM251ZW3D3 | | | |
| | | 3000 | MacAdam 2step | SPHWAHDNM251ZV2D3 | 13069 | 159 | |
| | | | MacAdam 3step | SPHWAHDNM251ZV3D3 | | | |
| | | 3500 | MacAdam 2step | SPHWAHDNM251ZU2D3 | 13452 | 164 | |
| | | | MacAdam 3step | SPHWAHDNM251ZU3D3 | | | |
| | | 4000 | MacAdam 2step | SPHWAHDNM251ZT2D3 | 13721 | 167 | |
| | | | MacAdam 3step | SPHWAHDNM251ZT3D3 | | | |
| | | 5000 | MacAdam 3step | SPHWAHDNM251ZR3D3 | 13836 | 168 | |
| | | 5700 | MacAdam 3step | SPHWAHDNM251ZQ3D3 | 13836 | 168 | |
| | | 6500 | MacAdam 3step | SPHWAHDNM251ZP3D3 | 13721 | 167 | |
| | | 90+ | 2700 | MacAdam 2step | SPHWAHDNM271ZW2D3 | 10643 | |
| | MacAdam 3step | | | SPHWAHDNM271ZW3D3 | | | |
| | 3000 | | MacAdam 2step | SPHWAHDNM271ZV2D3 | 11195 | 136 | |
| | | | MacAdam 3step | SPHWAHDNM271ZV3D3 | | | |
| | 3500 | | MacAdam 2step | SPHWAHDNM271ZU2D3 | 11529 | 140 | |
| | | | MacAdam 3step | SPHWAHDNM271ZU3D3 | | | |
| | 4000 | | MacAdam 2step | SPHWAHDNM271ZT2D3 | 11766 | 143 | |
| MacAdam 3step | | | SPHWAHDNM271ZT3D3 | | | | |
| 5000 | MacAdam 3step | | SPHWAHDNM271ZR3D3 | 11867 | 144 | | |

D-series

D-series Gen 2







| T _j =85°C | LC003D Gen 2 | LC006D Gen 2 | LC009D Gen 2 | LC013D Gen 2 | LC016D Gen 2 | LC019D Gen 2 | LC026D Gen 2 | LC033D Gen 2 | LC040D Gen 2 | LC060D Gen 2 | LC080D Gen 2 | |
|----------------------|-------------------|--------------------|--------------------|--------------------|---------------------|---------------------|--------------------|---------------------|----------------------|----------------------|---------------------|--|
| LES | 9.8mm | | | 14.5mm | | | | 22 mm | | | | |
| Typical | 34.6 V | | | | | | | | | | 52 V | |
| | 3.1 W (90 mA) | 6.2 W (180 mA) | 9.4 W (270 mA) | 12.5 W (360 mA) | 15.6 W (450 mA) | 18.7 W (540 mA) | 24.9 W (720 mA) | 31.1 W (900 mA) | 37.4 W (1080 mA) | 56.1 W (1080 mA) | 84.2 W (1620 mA) | |
| Max. | 8.6 W (230 mA) | 17.2 W (460 mA) | 25.9 W (690 mA) | 34.5 W (920 mA) | 43.1 W (1150 mA) | 51.8 W (1380 mA) | 69 W (1840 mA) | 86.2 W (2300 mA) | 103.5 W (2760 mA) | 143.4 W (2760 mA) | 215 W (4140 mA) | |
| Size | 13.5mm x 13.5mm | | | 19mm x 19mm | | | | 28mm x 28mm | | | | |

Color Variation

* CRI: Minimum

| Product | CRI95+ | | | | | CRI90+ | | | | | CRI80+ | | | | | | CRI70+ | | | |
|----------------|--------|-------|-------|-------|-------|--------|-------|-------|-------|-------|--------|-------|-------|-------|-------|-------|--------|-------|-------|-------|
| | 2700K | 3000K | 3500K | 4000K | 5000K | 2700K | 3000K | 3500K | 4000K | 5000K | 2700K | 3000K | 3500K | 4000K | 5000K | 5700K | 6500K | 3000K | 4000K | 5000K |
| LC003D Gen2 | | | | | | 0 | 0 | 0 | 0 | 0 | 0 | 0 | 0 | 0 | 0 | 0 | 0 | | | |
| LC006D Gen2 | | | | | | 0 | 0 | 0 | 0 | 0 | 0 | 0 | 0 | 0 | 0 | 0 | 0 | | | |
| LC009D Gen2 | | | | | | 0 | 0 | 0 | 0 | 0 | 0 | 0 | 0 | 0 | 0 | 0 | 0 | 0 | 0 | 0 |
| LC013D Gen2 | 0 | 0 | 0 | 0 | 0 | 0 | 0 | 0 | 0 | 0 | 0 | 0 | 0 | 0 | 0 | 0 | 0 | 0 | 0 | 0 |
| LC016D Gen2 | 0 | 0 | 0 | 0 | 0 | 0 | 0 | 0 | 0 | 0 | 0 | 0 | 0 | 0 | 0 | 0 | 0 | 0 | 0 | 0 |
| LC019D Gen2 | 0 | 0 | 0 | 0 | 0 | 0 | 0 | 0 | 0 | 0 | 0 | 0 | 0 | 0 | 0 | 0 | 0 | 0 | 0 | 0 |
| LC026D Gen2 | 0 | 0 | 0 | 0 | 0 | 0 | 0 | 0 | 0 | 0 | 0 | 0 | 0 | 0 | 0 | 0 | 0 | 0 | 0 | 0 |
| LC033D Gen2 | 0 | 0 | 0 | 0 | 0 | 0 | 0 | 0 | 0 | 0 | 0 | 0 | 0 | 0 | 0 | 0 | 0 | 0 | 0 | 0 |
| LC040D Gen2 | 0 | 0 | 0 | 0 | 0 | 0 | 0 | 0 | 0 | 0 | 0 | 0 | 0 | 0 | 0 | 0 | 0 | 0 | 0 | 0 |
| LC060D Gen2 | | | | | | 0 | 0 | 0 | 0 | 0 | 0 | 0 | 0 | 0 | 0 | 0 | 0 | 0 | 0 | 0 |
| LC080D Gen2 | | | | | | 0 | 0 | 0 | 0 | 0 | 0 | 0 | 0 | 0 | 0 | 0 | 0 | 0 | 0 | 0 |
| MacAdam 2-Step | 0 | 0 | 0 | 0 | | 0 | 0 | 0 | 0 | | 0 | 0 | 0 | 0 | | | | | | |
| MacAdam 3-Step | 0 | 0 | 0 | 0 | 0 | 0 | 0 | 0 | 0 | 0 | 0 | 0 | 0 | 0 | 0 | 0 | 0 | 0 | 0 | 0 |

Specifications

| Product | CRI | CCT (K) | Color Rank | Part Number | T _j = 85°C | | I _F (mA) V _F (V) | | |
|---|-------------------|---|-------------------|-------------------|-------------------------|-------------------------------|---|-----|----------------|
| | | | | | Luminous Flux Typ. (lm) | Luminous Efficacy Typ. (lm/W) | | | |
|  LC003D Gen 2 | 80+ | 2700 | MacAdam 2step | SPHWAHDNA25YZW2D2 | 459 | 147 | 90mA 34.6V | | |
| | | | MacAdam 3step | SPHWAHDNA25YZW3D2 | | | | | |
| | | 3000 | MacAdam 2step | SPHWAHDNA25YZV2D2 | 483 | 155 | | | |
| | | | MacAdam 3step | SPHWAHDNA25YZV3D2 | | | | | |
| | | 3500 | MacAdam 2step | SPHWAHDNA25YZU2D2 | 501 | 161 | | | |
| | | | MacAdam 3step | SPHWAHDNA25YZU3D2 | | | | | |
| | | 4000 | MacAdam 2step | SPHWAHDNA25YZT2D2 | 507 | 163 | | | |
| | | | MacAdam 3step | SPHWAHDNA25YZT3D2 | | | | | |
| | | 5000 | MacAdam 3step | SPHWAHDNA25YZR3D2 | 513 | 165 | | | |
| | | 5700 | MacAdam 3step | SPHWAHDNA25YZQ3D2 | 513 | 165 | | | |
| | | 6500 | MacAdam 3step | SPHWAHDNA25YZP3D2 | 507 | 163 | | | |
| | |  LC006D Gen 2 | 90+ | 2700 | MacAdam 2step | SPHWAHDNA27YZW2D2 | | 388 | 125 |
| | | | | | MacAdam 3step | SPHWAHDNA27YZW3D2 | | | |
| | | | | 3000 | MacAdam 2step | SPHWAHDNA27YZV2D2 | | 406 | 130 |
| MacAdam 3step | SPHWAHDNA27YZV3D2 | | | | | | | | |
| 3500 | MacAdam 2step | | | SPHWAHDNA27YZU2D2 | 419 | 135 | | | |
| | MacAdam 3step | | | SPHWAHDNA27YZU3D2 | | | | | |
| 4000 | MacAdam 2step | | | SPHWAHDNA27YZT2D2 | 427 | 137 | | | |
| | MacAdam 3step | | | SPHWAHDNA27YZT3D2 | | | | | |
| 5000 | MacAdam 3step | | | SPHWAHDNA27YZR3D2 | 430 | 138 | | | |
|  LC006D Gen 2 | 80+ | | | 2700 | MacAdam 2step | SPHWAHDNB25YZW2D2 | 924 | 148 | 180mA 34.6V |
| | | MacAdam 3step | SPHWAHDNB25YZW3D2 | | | | | | |
| | | 3000 | MacAdam 2step | SPHWAHDNB25YZV2D2 | 971 | 156 | | | |
| | | | MacAdam 3step | SPHWAHDNB25YZV3D2 | | | | | |
| | | 3500 | MacAdam 2step | SPHWAHDNB25YZU2D2 | 1001 | 161 | | | |
| | | | MacAdam 3step | SPHWAHDNB25YZU3D2 | | | | | |
| | | 4000 | MacAdam 2step | SPHWAHDNB25YZT2D2 | 1024 | 164 | | | |
| | | | MacAdam 3step | SPHWAHDNB25YZT3D2 | | | | | |
| | | 5000 | MacAdam 3step | SPHWAHDNB25YZR3D2 | 1030 | 165 | | | |
| | | 5700 | MacAdam 3step | SPHWAHDNB25YZQ3D2 | 1030 | 165 | | | |
| | | 6500 | MacAdam 3step | SPHWAHDNB25YZP3D2 | 1018 | 163 | | | |
| | |  LC006D Gen 2 | 90+ | 2700 | MacAdam 2step | SPHWAHDNB27YZW2D2 | 786 | 126 | |
| | | | | | MacAdam 3step | SPHWAHDNB27YZW3D2 | | | |
| | | | | 3000 | MacAdam 2step | SPHWAHDNB27YZV2D2 | 824 | 132 | |
| MacAdam 3step | SPHWAHDNB27YZV3D2 | | | | | | | | |
| 3500 | MacAdam 2step | | | SPHWAHDNB27YZU2D2 | 853 | 137 | | | |
| | MacAdam 3step | | | SPHWAHDNB27YZU3D2 | | | | | |
| 4000 | MacAdam 2step | | | SPHWAHDNB27YZT2D2 | 870 | 140 | | | |
| | MacAdam 3step | | | SPHWAHDNB27YZT3D2 | | | | | |
| 5000 | MacAdam 3step | SPHWAHDNB27YZR3D2 | 874 | 140 | | | | | |

Specifications

D-series

| Product | CRI | CCT (K) | Color Rank | Part Number | T _j = 85°C | | I _F (mA) V _F (V) |
|---|------|---------------|-------------------|-------------------|-------------------------|-------------------------------|---|
| | | | | | Luminous Flux Typ. (lm) | Luminous Efficacy Typ. (lm/W) | |
|  LC009D Gen 2 | 70+ | 3000 | MacAdam 3step | SPHWAHDNC23YZV3D2 | 1578 | 161 | 270mA 34.6V |
| | | 4000 | MacAdam 3step | SPHWAHDNC23YZT3D2 | 1654 | 169 | |
| | | 5000 | MacAdam 3step | SPHWAHDNC23YZR3D2 | 1707 | 174 | |
| | 80+ | 2700 | MacAdam 2step | SPHWAHDNC25YZW2D2 | 1342 | 144 | |
| | | | MacAdam 3step | SPHWAHDNC25YZW3D2 | | | |
| | | 3000 | MacAdam 2step | SPHWAHDNC25YZV2D2 | 1418 | 152 | |
| | | | MacAdam 3step | SPHWAHDNC25YZV3D2 | | | |
| | | 3500 | MacAdam 2step | SPHWAHDNC25YZU2D2 | 1459 | 156 | |
| | | | MacAdam 3step | SPHWAHDNC25YZU3D2 | | | |
| | | 4000 | MacAdam 2step | SPHWAHDNC25YZT2D2 | 1494 | 160 | |
| | | | MacAdam 3step | SPHWAHDNC25YZT3D2 | | | |
| | | 5000 | MacAdam 3step | SPHWAHDNC25YZR3D2 | 1506 | 161 | |
| | 5700 | MacAdam 3step | SPHWAHDNC25YZQ3D2 | 1506 | 161 | | |
| | 6500 | MacAdam 3step | SPHWAHDNC25YZP3D2 | 1488 | 159 | | |
| | 90+ | 2700 | MacAdam 2step | SPHWAHDNC27YZW2D2 | 1152 | 123 | |
| | | | MacAdam 3step | SPHWAHDNC27YZW3D2 | | | |
| | | 3000 | MacAdam 2step | SPHWAHDNC27YZV2D2 | 1206 | 129 | |
| | | | MacAdam 3step | SPHWAHDNC27YZV3D2 | | | |
| 3500 | | MacAdam 2step | SPHWAHDNC27YZU2D2 | 1245 | 133 | | |
| | | MacAdam 3step | SPHWAHDNC27YZU3D2 | | | | |
| 4000 | | MacAdam 2step | SPHWAHDNC27YZT2D2 | 1273 | 136 | | |
| | | MacAdam 3step | SPHWAHDNC27YZT3D2 | | | | |
| 5000 | | MacAdam 3step | SPHWAHDNC27YZR3D2 | 1278 | 137 | | |
| 70+ | 3000 | MacAdam 3step | SPHWAHDND23YZV3D2 | 2106 | 161 | 360mA 34.6V | |
| | | MacAdam 3step | SPHWAHDND23YZT3D2 | 2173 | 166 | | |
| | | MacAdam 3step | SPHWAHDND23YZR3D2 | 2207 | 169 | | |
| | 80+ | 2700 | MacAdam 2step | SPHWAHDND25YZW2D2 | 1764 | | 142 |
| | | | MacAdam 3step | SPHWAHDND25YZW3D2 | | | |
| | | 3000 | MacAdam 2step | SPHWAHDND25YZV2D2 | 1857 | | 149 |
| | | | MacAdam 3step | SPHWAHDND25YZV3D2 | | | |
| | | 3500 | MacAdam 2step | SPHWAHDND25YZU2D2 | 1915 | | 154 |
| | | | MacAdam 3step | SPHWAHDND25YZU3D2 | | | |
| | | 4000 | MacAdam 2step | SPHWAHDND25YZT2D2 | 1950 | | 157 |
| | | | MacAdam 3step | SPHWAHDND25YZT3D2 | | | |
| | | 5000 | MacAdam 3step | SPHWAHDND25YZR3D2 | 1967 | | 158 |
| | 5700 | MacAdam 3step | SPHWAHDND25YZQ3D2 | 1967 | 158 | | |
| | 6500 | MacAdam 3step | SPHWAHDND25YZP3D2 | 1938 | 156 | | |
| | 90+ | 2700 | MacAdam 2step | SPHWAHDND27YZW2D2 | 1509 | | 121 |
| | | | MacAdam 3step | SPHWAHDND27YZW3D2 | | | |
| | | 3000 | MacAdam 2step | SPHWAHDND27YZV2D2 | 1580 | | 127 |
| | | | MacAdam 3step | SPHWAHDND27YZV3D2 | | | |
| 3500 | | MacAdam 2step | SPHWAHDND27YZU2D2 | 1635 | 131 | | |
| | | MacAdam 3step | SPHWAHDND27YZU3D2 | | | | |
| 4000 | | MacAdam 2step | SPHWAHDND27YZT2D2 | 1670 | 134 | | |
| | | MacAdam 3step | SPHWAHDND27YZT3D2 | | | | |
| 5000 | | MacAdam 3step | SPHWAHDND27YZR3D2 | 1674 | 134 | | |

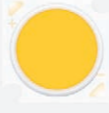
| Product | CRI | CCT (K) | Color Rank | Part Number | T _j = 85°C | | I _F (mA) V _F (V) |
|---|---------------|-------------------|-------------------|-------------------|-------------------------|-------------------------------|---|
| | | | | | Luminous Flux Typ. (lm) | Luminous Efficacy Typ. (lm/W) | |
|  LC013D Gen 2 | 95+ | 2700 | MacAdam 2step | SPHWAHDND28YZW2D2 | 1223 | 98 | 360mA 34.6V |
| | | | MacAdam 3step | SPHWAHDND28YZW3D2 | | | |
| | | 3000 | MacAdam 2step | SPHWAHDND28YZV2D2 | 1285 | 103 | |
| | | | MacAdam 3step | SPHWAHDND28YZV3D2 | | | |
| | | 3500 | MacAdam 2step | SPHWAHDND28YZU2D2 | 1337 | 107 | |
| | | | MacAdam 3step | SPHWAHDND28YZU3D2 | | | |
| | 4000 | MacAdam 2step | SPHWAHDND28YZT2D2 | 1379 | 111 | | |
| | | MacAdam 3step | SPHWAHDND28YZT3D2 | | | | |
| | 70+ | 3000 | MacAdam 3step | SPHWAHDNE23YZV3D2 | 2617 | 168 | |
| | | | MacAdam 3step | SPHWAHDNE23YZT3D2 | 2701 | 173 | |
| | | | MacAdam 3step | SPHWAHDNE23YZR3D2 | 2742 | 176 | |
| | | 2700 | MacAdam 2step | SPHWAHDNE25YZW2D2 | 2293 | 147 | |
| MacAdam 3step | | | SPHWAHDNE25YZW3D2 | | | | |
| MacAdam 2step | | | SPHWAHDNE25YZV2D2 | 2423 | 156 | | |
| 80+ | 3000 | MacAdam 3step | SPHWAHDNE25YZV3D2 | | | | |
| | | MacAdam 2step | SPHWAHDNE25YZU2D2 | 2513 | 161 | | |
| | 3500 | MacAdam 3step | SPHWAHDNE25YZU3D2 | | | | |
| | | MacAdam 2step | SPHWAHDNE25YZT2D2 | 2558 | 164 | | |
| | 4000 | MacAdam 3step | SPHWAHDNE25YZT3D2 | | | | |
| | | MacAdam 2step | SPHWAHDNE25YZR3D2 | 2581 | 166 | | |
| | 5000 | MacAdam 3step | SPHWAHDNE25YZQ3D2 | 2581 | 166 | | |
| | | MacAdam 3step | SPHWAHDNE25YZP3D2 | 2558 | 164 | | |
| | 90+ | 2700 | MacAdam 2step | SPHWAHDNE27YZW2D2 | 1967 | 126 | 450mA 34.6V |
| MacAdam 3step | | | SPHWAHDNE27YZW3D2 | | | | |
| 3000 | | | MacAdam 2step | SPHWAHDNE27YZV2D2 | 2084 | 134 | |
| | | | MacAdam 3step | SPHWAHDNE27YZV3D2 | | | |
| 3500 | | | MacAdam 2step | SPHWAHDNE27YZU2D2 | 2146 | 138 | |
| | | | MacAdam 3step | SPHWAHDNE27YZU3D2 | | | |
| 4000 | | MacAdam 2step | SPHWAHDNE27YZT2D2 | 2189 | 141 | | |
| | | MacAdam 3step | SPHWAHDNE27YZT3D2 | | | | |
| 5000 | | MacAdam 3step | SPHWAHDNE27YZR3D2 | 2209 | 142 | | |
| | | 2700 | MacAdam 2step | SPHWAHDNE28YZW2D2 | 1575 | 101 | |
| | | | MacAdam 3step | SPHWAHDNE28YZW3D2 | | | |
| | | 3000 | MacAdam 2step | SPHWAHDNE28YZV2D2 | 1655 | 106 | |
| | MacAdam 3step | | SPHWAHDNE28YZV3D2 | | | | |
| | 3500 | MacAdam 2step | SPHWAHDNE28YZU2D2 | 1722 | 111 | | |
| MacAdam 3step | | SPHWAHDNE28YZU3D2 | | | | | |
| 95+ | 4000 | MacAdam 2step | SPHWAHDNE28YZT2D2 | 1776 | 114 | | |
| | | MacAdam 3step | SPHWAHDNE28YZT3D2 | | | | |
| | 5000 | MacAdam 2step | SPHWAHDNE28YZR3D2 | 1791 | 115 | | |
| | | MacAdam 3step | SPHWAHDNE28YZR3D2 | | | | |

D-series

Specifications

D-series

| Product | CRI | CCT (K) | Color Rank | Part Number | T _j = 85°C | | I _F (mA) V _F (V) | |
|---|---------------|---------------|-------------------|-------------------|-------------------------|-------------------------------|---|----------------|
| | | | | | Luminous Flux Typ. (lm) | Luminous Efficacy Typ. (lm/W) | | |
|  LC019D Gen 2 | 70+ | 3000 | MacAdam 3step | SPHWAHDNF23YZV3D2 | 3107 | 166 | 540mA 34.6V | |
| | | 4000 | MacAdam 3step | SPHWAHDNF23YZT3D2 | 3207 | 172 | | |
| | | 5000 | MacAdam 3step | SPHWAHDNF23YZR3D2 | 3256 | 174 | | |
| | 80+ | 2700 | MacAdam 2step | SPHWAHDNF25YZW2D2 | 2728 | 146 | | |
| | | | MacAdam 3step | SPHWAHDNF25YZW3D2 | | | | |
| | | 3000 | MacAdam 2step | SPHWAHDNF25YZV2D2 | 2877 | 154 | | |
| | | | MacAdam 3step | SPHWAHDNF25YZV3D2 | | | | |
| | | 3500 | MacAdam 2step | SPHWAHDNF25YZU2D2 | 2965 | 159 | | |
| | | | MacAdam 3step | SPHWAHDNF25YZU3D2 | | | | |
| | | 4000 | MacAdam 2step | SPHWAHDNF25YZT2D2 | 3026 | 162 | | |
| | | | MacAdam 3step | SPHWAHDNF25YZT3D2 | | | | |
| | | 5000 | MacAdam 3step | SPHWAHDNF25YZR3D2 | 3059 | 164 | | |
| | | | 5700 | MacAdam 3step | SPHWAHDNF25YZQ3D2 | 3059 | | 164 |
| | | | 6500 | MacAdam 3step | SPHWAHDNF25YZP3D2 | 3026 | | 162 |
| | | 90+ | 2700 | MacAdam 2step | SPHWAHDNF27YZW2D2 | 2336 | | 125 |
| | MacAdam 3step | | | SPHWAHDNF27YZW3D2 | | | | |
| | 3000 | | MacAdam 2step | SPHWAHDNF27YZV2D2 | 2449 | 131 | | |
| | | | MacAdam 3step | SPHWAHDNF27YZV3D2 | | | | |
| | 3500 | | MacAdam 2step | SPHWAHDNF27YZU2D2 | 2539 | 136 | | |
| | | | MacAdam 3step | SPHWAHDNF27YZU3D2 | | | | |
| | 4000 | | MacAdam 2step | SPHWAHDNF27YZT2D2 | 2594 | 139 | | |
| | | | MacAdam 3step | SPHWAHDNF27YZT3D2 | | | | |
| | 5000 | | MacAdam 3step | SPHWAHDNF27YZR3D2 | 2596 | 139 | | |
| | | | 2700 | MacAdam 2step | SPHWAHDNF28YZW2D2 | 1880 | | 101 |
| | | | | MacAdam 3step | SPHWAHDNF28YZW3D2 | | | |
| | 95+ | | 3000 | MacAdam 2step | SPHWAHDNF28YZV2D2 | 1976 | | 106 |
| | | MacAdam 3step | | SPHWAHDNF28YZV3D2 | | | | |
| 3500 | | MacAdam 2step | SPHWAHDNF28YZU2D2 | 2056 | 110 | | | |
| | | MacAdam 3step | SPHWAHDNF28YZU3D2 | | | | | |
| 4000 | | MacAdam 2step | SPHWAHDNF28YZT2D2 | 2121 | 114 | | | |
| | | MacAdam 3step | SPHWAHDNF28YZT3D2 | | | | | |
| 5000 | | MacAdam 3step | SPHWAHDNF28YZR3D2 | 2138 | 114 | | | |
| | | 70+ | 3000 | MacAdam 3step | SPHWAHDNG23YZV3D2 | 4063 | 163 | 720mA 34.6V |
| | 4000 | | MacAdam 3step | SPHWAHDNG23YZT3D2 | 4193 | 168 | | |
| 5000 | MacAdam 3step | | SPHWAHDNG23YZR3D2 | 4258 | 171 | | | |
| 80+ | 2700 | MacAdam 2step | SPHWAHDNG25YZW2D2 | 3580 | 144 | | | |
| | | MacAdam 3step | SPHWAHDNG25YZW3D2 | | | | | |
| | 3000 | MacAdam 2step | SPHWAHDNG25YZV2D2 | 3762 | 151 | | | |
| | | MacAdam 3step | SPHWAHDNG25YZV3D2 | | | | | |
| | 3500 | MacAdam 2step | SPHWAHDNG25YZU2D2 | 3872 | 155 | | | |
| | | MacAdam 3step | SPHWAHDNG25YZU3D2 | | | | | |
| | 4000 | MacAdam 2step | SPHWAHDNG25YZT2D2 | 3950 | 159 | | | |
| | | MacAdam 3step | SPHWAHDNG25YZT3D2 | | | | | |
| | 5000 | MacAdam 3step | SPHWAHDNG25YZR3D2 | 3983 | 160 | | | |
| | | 5700 | MacAdam 3step | SPHWAHDNG25YZQ3D2 | 3983 | 160 | | |
| | | 6500 | MacAdam 3step | SPHWAHDNG25YZP3D2 | 3950 | 159 | | |

| Product | CRI | CCT (K) | Color Rank | Part Number | T _j = 85°C | | I _F (mA) V _F (V) | | |
|---|-------------------|-------------------|-------------------|-------------------|-------------------------|-------------------------------|---|----------------|-----|
| | | | | | Luminous Flux Typ. (lm) | Luminous Efficacy Typ. (lm/W) | | | |
|  LC026D Gen 2 | 90+ | 2700 | MacAdam 2step | SPHWAHDNG27YZW2D2 | 3064 | 123 | 720mA 34.6V | | |
| | | | MacAdam 3step | SPHWAHDNG27YZW3D2 | | | | | |
| | | 3000 | MacAdam 2step | SPHWAHDNG27YZV2D2 | 3223 | 129 | | | |
| | | | MacAdam 3step | SPHWAHDNG27YZV3D2 | | | | | |
| | | 3500 | MacAdam 2step | SPHWAHDNG27YZU2D2 | 3319 | 133 | | | |
| | | | MacAdam 3step | SPHWAHDNG27YZU3D2 | | | | | |
| | | 4000 | MacAdam 2step | SPHWAHDNG27YZT2D2 | 3387 | 136 | | | |
| | | | MacAdam 3step | SPHWAHDNG27YZT3D2 | | | | | |
| | | 5000 | MacAdam 3step | SPHWAHDNG27YZR3D2 | 3416 | 137 | | | |
| | | | 2700 | MacAdam 2step | SPHWAHDNG28YZW2D2 | 2470 | | 99 | |
| | | | | MacAdam 3step | SPHWAHDNG28YZW3D2 | | | | |
| | | 95+ | 3000 | MacAdam 2step | SPHWAHDNG28YZV2D2 | 2596 | | 104 | |
| | MacAdam 3step | | | SPHWAHDNG28YZV3D2 | | | | | |
| | 3500 | | MacAdam 2step | SPHWAHDNG28YZU2D2 | 2701 | 108 | | | |
| | | | MacAdam 3step | SPHWAHDNG28YZU3D2 | | | | | |
| | 4000 | | MacAdam 2step | SPHWAHDNG28YZT2D2 | 2786 | 112 | | | |
| | | | MacAdam 3step | SPHWAHDNG28YZT3D2 | | | | | |
| | 5000 | MacAdam 3step | SPHWAHDNG28YZR3D2 | 2809 | 113 | | | | |
| | 70+ | 3000 | MacAdam 3step | SPHWAHDNH23YZV3D2 | 5014 | 161 | | 900mA 34.6V | |
| | | | 4000 | MacAdam 3step | SPHWAHDNH23YZT3D2 | 5175 | | | 166 |
| | | | 5000 | MacAdam 3step | SPHWAHDNH23YZR3D2 | 5255 | | | 169 |
| | | 80+ | 2700 | MacAdam 2step | SPHWAHDNH25YZW2D2 | 4418 | | | 142 |
| | | | | MacAdam 3step | SPHWAHDNH25YZW3D2 | | | | |
| | | | 3000 | MacAdam 2step | SPHWAHDNH25YZV2D2 | 4643 | | | 149 |
| | | | | MacAdam 3step | SPHWAHDNH25YZV3D2 | | | | |
| | | | 3500 | MacAdam 2step | SPHWAHDNH25YZU2D2 | 4779 | | | 153 |
| | | | | MacAdam 3step | SPHWAHDNH25YZU3D2 | | | | |
| 4000 | | MacAdam 2step | SPHWAHDNH25YZT2D2 | 4875 | 157 | | | | |
| | | MacAdam 3step | SPHWAHDNH25YZT3D2 | | | | | | |
| | | 5000 | MacAdam 3step | | | SPHWAHDNH25YZR3D2 | 4916 | | 158 |
| 5700 | | MacAdam 3step | SPHWAHDNH25YZQ3D2 | 4916 | 158 | | | | |
| | | 6500 | MacAdam 3step | SPHWAHDNH25YZP3D2 | 4875 | 157 | | | |
| | | 90+ | 2700 | MacAdam 2step | SPHWAHDNH27YZW2D2 | 3781 | 121 | | |
| MacAdam 3step | SPHWAHDNH27YZW3D2 | | | | | | | | |
| 3000 | MacAdam 2step | | SPHWAHDNH27YZV2D2 | 3977 | 128 | | | | |
| | MacAdam 3step | | SPHWAHDNH27YZV3D2 | | | | | | |
| 3500 | MacAdam 2step | | SPHWAHDNH27YZU2D2 | 4096 | 132 | | | | |
| | MacAdam 3step | | SPHWAHDNH27YZU3D2 | | | | | | |
| 4000 | MacAdam 2step | | SPHWAHDNH27YZT2D2 | 4180 | 134 | | | | |
| | MacAdam 3step | | SPHWAHDNH27YZT3D2 | | | | | | |
| 5000 | MacAdam 3step | | SPHWAHDNH27YZR3D2 | 4216 | 135 | | | | |
| | 2700 | | MacAdam 2step | SPHWAHDNH28YZW2D2 | 3057 | 98 | | | |
| | | | MacAdam 3step | SPHWAHDNH28YZW3D2 | | | | | |
| 3000 | MacAdam 2step | | SPHWAHDNH28YZV2D2 | 3212 | 103 | | | | |
| | MacAdam 3step | SPHWAHDNH28YZV3D2 | | | | | | | |
| | 3500 | MacAdam 2step | SPHWAHDNH28YZU2D2 | | | 3343 | 107 | | |
| MacAdam 3step | SPHWAHDNH28YZU3D2 | | | | | | | | |
| 4000 | MacAdam 2step | SPHWAHDNH28YZT2D2 | 3447 | 111 | | | | | |
| | MacAdam 3step | SPHWAHDNH28YZT3D2 | | | | | | | |
| | 5000 | MacAdam 3step | | | SPHWAHDNH28YZR3D2 | 3476 | 112 | | |

D-series

Specifications

D-series

| Product | CRI | CCT (K) | Color Rank | Part Number | T _j = 85°C | | I _F (mA) V _F (V) |
|---|------|---------------|-------------------|-------------------|-------------------------|-------------------------------|---|
| | | | | | Luminous Flux Typ. (lm) | Luminous Efficacy Typ. (lm/W) | |
|  LC040D Gen 2 | 70+ | 3000 | MacAdam 3step | SPHWAHDNK23YZV3D2 | 6304 | 169 | 1080mA 34.6V |
| | | 4000 | MacAdam 3step | SPHWAHDNK23YZT3D2 | 6506 | 174 | |
| | | 5000 | MacAdam 3step | SPHWAHDNK23YZR3D2 | 6607 | 177 | |
| | 80+ | 2700 | MacAdam 2step | SPHWAHDNK25YZW2D2 | 5547 | 148 | |
| | | | MacAdam 3step | SPHWAHDNK25YZW3D2 | | | |
| | | 3000 | MacAdam 2step | SPHWAHDNK25YZV2D2 | 5837 | 156 | |
| | | | MacAdam 3step | SPHWAHDNK25YZV3D2 | | | |
| | | 3500 | MacAdam 2step | SPHWAHDNK25YZU2D2 | 6016 | 161 | |
| | | | MacAdam 3step | SPHWAHDNK25YZU3D2 | | | |
| | | 4000 | MacAdam 2step | SPHWAHDNK25YZT2D2 | 6146 | 164 | |
| | | | MacAdam 3step | SPHWAHDNK25YZT3D2 | | | |
| | | 5000 | MacAdam 3step | SPHWAHDNK25YZR3D2 | 6175 | 165 | |
| | | | MacAdam 3step | SPHWAHDNK25YZQ3D2 | 6205 | 166 | |
| | | 6500 | MacAdam 3step | SPHWAHDNK25YZP3D2 | 6138 | 164 | |
| | | | | | | | |
| | 90+ | 2700 | MacAdam 2step | SPHWAHDNK27YZW2D2 | 4755 | 127 | |
| | | | MacAdam 3step | SPHWAHDNK27YZW3D2 | | | |
| | | 3000 | MacAdam 2step | SPHWAHDNK27YZV2D2 | 5024 | 134 | |
| | | | MacAdam 3step | SPHWAHDNK27YZV3D2 | | | |
| | | 3500 | MacAdam 2step | SPHWAHDNK27YZU2D2 | 5152 | 138 | |
| | | | MacAdam 3step | SPHWAHDNK27YZU3D2 | | | |
| | | 4000 | MacAdam 2step | SPHWAHDNK27YZT2D2 | 5266 | 141 | |
| | | | MacAdam 3step | SPHWAHDNK27YZT3D2 | | | |
| | | 5000 | MacAdam 3step | SPHWAHDNK27YZR3D2 | 5325 | 143 | |
| | | | | | | | |
| 95+ | | 2700 | MacAdam 2step | SPHWAHDNK28YZW2D2 | 3760 | 101 | |
| | | | MacAdam 3step | SPHWAHDNK28YZW3D2 | | | |
| | 3000 | MacAdam 2step | SPHWAHDNK28YZV2D2 | 3952 | 106 | | |
| | | MacAdam 3step | SPHWAHDNK28YZV3D2 | | | | |
| | 3500 | MacAdam 2step | SPHWAHDNK28YZU2D2 | 4113 | 110 | | |
| | | MacAdam 3step | SPHWAHDNK28YZU3D2 | | | | |
| | 4000 | MacAdam 2step | SPHWAHDNK28YZT2D2 | 4241 | 113 | | |
| | | MacAdam 3step | SPHWAHDNK28YZT3D2 | | | | |
| | 5000 | MacAdam 3step | SPHWAHDNK28YZR3D2 | 4277 | 114 | | |
| | | | | | | | |
| | 70+ | 3000 | MacAdam 3step | SPHWAHDNL231ZV3D2 | 9225 | 164 | 1080mA 52V |
| | | | MacAdam 3step | SPHWAHDNL231ZT3D2 | 9521 | 170 | |
| MacAdam 3step | | | SPHWAHDNL231ZR3D2 | 9668 | 172 | | |
| 2700 | | MacAdam 2step | SPHWAHDNL251ZW2D2 | 8107 | 144 | | |
| | | MacAdam 3step | SPHWAHDNL251ZW3D2 | | | | |
| 3000 | | MacAdam 2step | SPHWAHDNL251ZV2D2 | 8542 | 152 | | |
| | | MacAdam 3step | SPHWAHDNL251ZV3D2 | | | | |
| 3500 | | MacAdam 2step | SPHWAHDNL251ZU2D2 | 8812 | 157 | | |
| | | MacAdam 3step | SPHWAHDNL251ZU3D2 | | | | |
| 4000 | | MacAdam 2step | SPHWAHDNL251ZT2D2 | 8995 | 160 | | |
| | | MacAdam 3step | SPHWAHDNL251ZT3D2 | | | | |
| 5000 | | MacAdam 3step | SPHWAHDNL251ZR3D2 | 9039 | 161 | | |
| | | MacAdam 3step | SPHWAHDNL251ZQ3D2 | 9084 | 162 | | |
| 6500 | | MacAdam 3step | SPHWAHDNL251ZP3D2 | 8990 | 160 | | |
| | | | | | | | |

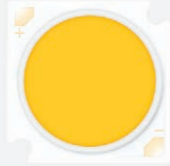
| Product | CRI | CCT (K) | Color Rank | Part Number | T _j = 85°C | | I _F (mA) V _F (V) | |
|---|---------------|---------------|-------------------|-------------------|-------------------------|-------------------------------|---|---------------|
| | | | | | Luminous Flux Typ. (lm) | Luminous Efficacy Typ. (lm/W) | | |
|  LC060D Gen 2 | 90+ | 2700 | MacAdam 2step | SPHWAHDNL271ZW2D2 | 6959 | 124 | 1080mA 52V | |
| | | | MacAdam 3step | SPHWAHDNL271ZW3D2 | | | | |
| | | 3000 | MacAdam 2step | SPHWAHDNL271ZV2D2 | 7352 | 131 | | |
| | | | MacAdam 3step | SPHWAHDNL271ZV3D2 | | | | |
| | | 3500 | MacAdam 2step | SPHWAHDNL271ZU2D2 | 7539 | 134 | | |
| | | | MacAdam 3step | SPHWAHDNL271ZU3D2 | | | | |
| | 4000 | MacAdam 2step | SPHWAHDNL271ZT2D2 | 7706 | 137 | | | |
| | | MacAdam 3step | SPHWAHDNL271ZT3D2 | | | | | |
| | 5000 | MacAdam 3step | SPHWAHDNL271ZR3D2 | 7793 | 139 | | | |
| | | | | | | | | |
| | 70+ | 3000 | MacAdam 3step | SPHWAHDNM231ZV3D2 | 13465 | 160 | | 1620mA 52V |
| | | | MacAdam 3step | SPHWAHDNM231ZT3D2 | 13896 | 165 | | |
| MacAdam 3step | | | SPHWAHDNM231ZR3D2 | 14112 | 168 | | | |
| 2700 | | MacAdam 2step | SPHWAHDNM251ZW2D2 | 11815 | 140 | | | |
| | | MacAdam 3step | SPHWAHDNM251ZW3D2 | | | | | |
| 3000 | | MacAdam 2step | SPHWAHDNM251ZV2D2 | 12468 | 148 | | | |
| | | MacAdam 3step | SPHWAHDNM251ZV3D2 | | | | | |
| 3500 | | MacAdam 2step | SPHWAHDNM251ZU2D2 | 12852 | 153 | | | |
| | | MacAdam 3step | SPHWAHDNM251ZU3D2 | | | | | |
| 4000 | | MacAdam 2step | SPHWAHDNM251ZT2D2 | 13123 | 156 | | | |
| | | MacAdam 3step | SPHWAHDNM251ZT3D2 | | | | | |
| 5000 | | MacAdam 3step | SPHWAHDNM251ZR3D2 | 13196 | 157 | | | |
| | | MacAdam 3step | SPHWAHDNM251ZQ3D2 | 13258 | 157 | | | |
| 6500 | | MacAdam 3step | SPHWAHDNM251ZP3D2 | 13121 | 156 | | | |
| | | | | | | | | |
| 90+ | | 2700 | MacAdam 2step | SPHWAHDNM271ZW2D2 | 10157 | 121 | | |
| | | | MacAdam 3step | SPHWAHDNM271ZW3D2 | | | | |
| | | 3000 | MacAdam 2step | SPHWAHDNM271ZV2D2 | 10731 | 127 | | |
| | MacAdam 3step | | SPHWAHDNM271ZV3D2 | | | | | |
| | 3500 | MacAdam 2step | SPHWAHDNM271ZU2D2 | 11004 | 131 | | | |
| | | MacAdam 3step | SPHWAHDNM271ZU3D2 | | | | | |
| | 4000 | MacAdam 2step | SPHWAHDNM271ZT2D2 | 11247 | 134 | | | |
| | | MacAdam 3step | SPHWAHDNM271ZT3D2 | | | | | |
| | 5000 | MacAdam 3step | SPHWAHDNM271ZR3D2 | 11375 | 135 | | | |
| | | | | | | | | |

D-series



D-series Gen 1

| T _j =85°C | LC003D Gen1 | LC006D Gen1 | LC009D Gen1 | LC013D Gen1 | LC016D Gen1 | LC019D Gen1 | LC026D Gen1 | LC040D Gen1 | LC060D Gen1 | LC080D Gen1 |
|----------------------|----------------|-----------------|-----------------|-----------------|------------------|------------------|-----------------|-------------------|-------------------|------------------|
| LES | 9.8mm | | | 14.5mm | | | 22mm | | | |
| Typical | 34.6 V | | | | | | | | 52 V | |
| | 3.1 W (90 mA) | 6.2 W (180 mA) | 9.4 W (270 mA) | 12.5 W (360 mA) | 15.6 W (450 mA) | 18.7 W (540 mA) | 24.9 W (720 mA) | 37.4 W (1080 mA) | 56.1 W (1080 mA) | 84.2 W (1620 mA) |
| Max. | 8.6 W (230 mA) | 17.2 W (460 mA) | 25.9 W (690 mA) | 34.5 W (920 mA) | 43.1 W (1150 mA) | 51.8 W (1380 mA) | 69 W (1840 mA) | 103.5 W (2760 mA) | 143.4 W (2760 mA) | 215 W (2760 mA) |
| Size | 13.5 x 13.5mm | | | 19 x 19mm | | | 28 x 28mm | | | |

Color Variation

* CRI: Minimum

| Product | CRI90+ | | | | | CRI80+ | | | | | | | CRI70+ | | |
|----------------|--------|-------|-------|-------|-------|--------|-------|-------|-------|-------|-------|-------|--------|-------|-------|
| | 2700K | 3000K | 3500K | 4000K | 5000K | 2700K | 3000K | 3500K | 4000K | 5000K | 5700K | 6500K | 3000K | 4000K | 5000K |
| LC003D Gen1 | o | o | o | o | o | o | o | o | o | o | o | o | | | |
| LC006D Gen1 | o | o | o | o | o | o | o | o | o | o | o | o | | | |
| LC009D Gen1 | o | o | o | o | o | o | o | o | o | o | o | o | | | |
| LC013D Gen1 | o | o | o | o | o | o | o | o | o | o | o | o | | | |
| LC016D Gen1 | o | o | o | o | o | o | o | o | o | o | o | o | | | |
| LC019D Gen1 | o | o | o | o | o | o | o | o | o | o | o | o | | | |
| LC026D Gen1 | o | o | o | o | o | o | o | o | o | o | o | o | | | |
| LC040D Gen1 | o | o | o | o | o | o | o | o | o | o | o | o | | | |
| LC060D Gen1 | | | | | | o | o | o | o | o | o | o | o | o | o |
| LC080D Gen1 | | | | | | o | o | o | o | o | o | o | o | o | o |
| MacAdam 2-Step | o | o | o | o | o | o | o | o | o | | | | | | |
| MacAdam 3-Step | o | o | o | o | o | o | o | o | o | o | o | o | o | o | o |

Specifications

| Product | CRI | CCT (K) | Color Rank | Part Number | T _j = 85°C | | I _F (mA) V _F (V) | |
|---------------|-------------------|---------------|-------------------|-------------------|-------------------------|-------------------------------|---|-----|
| | | | | | Luminous Flux Typ. (lm) | Luminous Efficacy Typ. (lm/W) | | |
| LC003D Gen1 | 80+ | 2700 | MacAdam 2step | SPHWAHDNA25YZW2A9 | 413 | 133 | 90mA 34.6V | |
| | | | MacAdam 3step | SPHWAHDNA25YZW3A9 | | | | |
| | | | MacAdam 2step | SPHWAHDNA25YZW2D1 | 434 | 139 | | |
| | | | MacAdam 3step | SPHWAHDNA25YZW3D1 | | | | |
| | | | 3000 | MacAdam 2step | SPHWAHDNA25YZV2B1 | 435 | | 140 |
| | | | | MacAdam 3step | SPHWAHDNA25YZV3B1 | | | |
| | | MacAdam 2step | | SPHWAHDNA25YZV2D1 | 457 | 147 | | |
| | | MacAdam 3step | | SPHWAHDNA25YZV3D1 | | | | |
| | | 3500 | MacAdam 2step | SPHWAHDNA25YZU2B2 | 451 | 145 | | |
| | | | MacAdam 3step | SPHWAHDNA25YZU3B2 | | | | |
| | | | MacAdam 2step | SPHWAHDNA25YZU2D1 | 474 | 152 | | |
| | | MacAdam 3step | SPHWAHDNA25YZU3D1 | | | | | |
| | | 4000 | MacAdam 2step | SPHWAHDNA25YZT2B3 | 457 | 147 | | |
| | | | MacAdam 3step | SPHWAHDNA25YZT3B3 | | | | |
| | | | MacAdam 2step | SPHWAHDNA25YZT2D1 | 480 | 154 | | |
| | | MacAdam 3step | SPHWAHDNA25YZT3D1 | | | | | |
| | | 5000 | MacAdam 3step | SPHWAHDNA25YZR3B3 | 462 | 148 | | |
| | | | | SPHWAHDNA25YZR3D1 | 485 | 156 | | |
| | | 5700 | MacAdam 3step | SPHWAHDNA25YZQ3B3 | 462 | 148 | | |
| | | | | SPHWAHDNA25YZQ3D1 | 485 | 156 | | |
| | | 6500 | MacAdam 3step | SPHWAHDNA25YZP3B3 | 457 | 147 | | |
| | | | | SPHWAHDNA25YZP3D1 | 480 | 154 | | |
| | | 90+ | 2700 | MacAdam 2step | SPHWAHDNA27YZW2A3 | 349 | | 112 |
| | | | | MacAdam 3step | SPHWAHDNA27YZW3A3 | | | |
| MacAdam 2step | SPHWAHDNA27YZW2D1 | | | 367 | 118 | | | |
| MacAdam 3step | SPHWAHDNA27YZW3D1 | | | | | | | |
| 3000 | MacAdam 2step | | | SPHWAHDNA27YZV2A4 | 365 | 117 | | |
| | MacAdam 3step | | | SPHWAHDNA27YZV3A4 | | | | |
| | MacAdam 2step | | SPHWAHDNA27YZV2D1 | 384 | 123 | | | |
| MacAdam 3step | SPHWAHDNA27YZV3D1 | | | | | | | |
| 3500 | MacAdam 2step | | SPHWAHDNA27YZU2A5 | 377 | 121 | | | |
| | MacAdam 3step | | SPHWAHDNA27YZU3A5 | | | | | |
| | MacAdam 2step | | SPHWAHDNA27YZU2D1 | 396 | 127 | | | |
| | MacAdam 3step | | SPHWAHDNA27YZU3D1 | | | | | |
| 4000 | MacAdam 2step | | SPHWAHDNA27YZT2A6 | 385 | 124 | | | |
| | MacAdam 3step | | SPHWAHDNA27YZT3A6 | | | | | |
| | MacAdam 2step | | SPHWAHDNA27YZT2D1 | 404 | 130 | | | |
| MacAdam 3step | SPHWAHDNA27YZT3D1 | | | | | | | |
| 5000 | MacAdam 3step | | SPHWAHDNA27YZR3A6 | 387 | 124 | | | |
| | | | SPHWAHDNA27YZR3D1 | 407 | 131 | | | |

Specifications

D-series

| Product | CRI | CCT (K) | Color Rank | Part Number | T _j = 85°C | | I _F (mA) V _F (V) | |
|---|---------------|-------------------|-------------------|-------------------|-------------------------|-------------------------------|---|-----|
| | | | | | Luminous Flux Typ. (lm) | Luminous Efficacy Typ. (lm/W) | | |
|  LC006D Gen 1 | 80+ | 2700 | MacAdam 2step | SPHWAHDNB25YZW2E9 | 832 | 134 | 180mA 34.6V | |
| | | | MacAdam 3step | SPHWAHDNB25YZW3E9 | | | | |
| | | | MacAdam 2step | SPHWAHDNB25YZW2D1 | | | | |
| | | | MacAdam 3step | SPHWAHDNB25YZW3D1 | | | | |
| | | 3000 | MacAdam 2step | SPHWAHDNB25YZV2F3 | 875 | 140 | | |
| | | | MacAdam 3step | SPHWAHDNB25YZV3F3 | | | | |
| | | | MacAdam 2step | SPHWAHDNB25YZV2D1 | | | | |
| | | | MacAdam 3step | SPHWAHDNB25YZV3D1 | | | | |
| | | 3500 | MacAdam 2step | SPHWAHDNB25YZU2F5 | 902 | 145 | | |
| | | | MacAdam 3step | SPHWAHDNB25YZU3F5 | | | | |
| | | | MacAdam 2step | SPHWAHDNB25YZU2D1 | | | | |
| | | | MacAdam 3step | SPHWAHDNB25YZU3D1 | | | | |
| | | 4000 | MacAdam 2step | SPHWAHDNB25YZT2F8 | 923 | 148 | | |
| | | | MacAdam 3step | SPHWAHDNB25YZT3F8 | | | | |
| | | | MacAdam 2step | SPHWAHDNB25YZT2D1 | | | | |
| | | | MacAdam 3step | SPHWAHDNB25YZT3D1 | | | | |
| | | 5000 | MacAdam 3step | SPHWAHDNB25YZR3F8 | 928 | 149 | | |
| | | | | SPHWAHDNB25YZR3D1 | 975 | 157 | | |
| | | 5700 | MacAdam 3step | SPHWAHDNB25YZQ3F8 | 928 | 149 | | |
| | | | | SPHWAHDNB25YZQ3D1 | 975 | 157 | | |
| | | 6500 | MacAdam 3step | SPHWAHDNB25YZP3F7 | 918 | 147 | | |
| | | | | SPHWAHDNB25YZP3D1 | 964 | 155 | | |
| | | 90+ | 2700 | MacAdam 2step | SPHWAHDNB27YZW2D7 | 709 | | 114 |
| | | | | MacAdam 3step | SPHWAHDNB27YZW3D7 | | | |
| | MacAdam 2step | | | SPHWAHDNB27YZW2D1 | | | | |
| | MacAdam 3step | | | SPHWAHDNB27YZW3D1 | | | | |
| | 3000 | | MacAdam 2step | SPHWAHDNB27YZV2E9 | 743 | 119 | | |
| | | | MacAdam 3step | SPHWAHDNB27YZV3E9 | | | | |
| | | | MacAdam 2step | SPHWAHDNB27YZV2D1 | | | | |
| | 3000 | | MacAdam 3step | SPHWAHDNB27YZV3D1 | 780 | 125 | | |
| | | | MacAdam 2step | SPHWAHDNB27YZU2E0 | | | | |
| | | | MacAdam 3step | SPHWAHDNB27YZU3E0 | | | | |
| | 3500 | | MacAdam 2step | SPHWAHDNB27YZU2D1 | 807 | 130 | | |
| | | | MacAdam 3step | SPHWAHDNB27YZU3D1 | | | | |
| | | | MacAdam 2step | SPHWAHDNB27YZT2E4 | | | | |
| | | | MacAdam 3step | SPHWAHDNB27YZT3E4 | | | | |
| 4000 | MacAdam 2step | | SPHWAHDNB27YZT2D1 | 824 | 132 | | | |
| | MacAdam 3step | | SPHWAHDNB27YZT3D1 | | | | | |
| | MacAdam 2step | SPHWAHDNB27YZR3E4 | | | | | | |
| | MacAdam 3step | SPHWAHDNB27YZR3D1 | | | | | | |
| 5000 | MacAdam 3step | SPHWAHDNB27YZR3E4 | 787 | 126 | | | | |
| | | SPHWAHDNB27YZR3D1 | 827 | 133 | | | | |

| Product | CRI | CCT (K) | Color Rank | Part Number | T _j = 85°C | | I _F (mA) V _F (V) | |
|---|---------------|-------------------|-------------------|-------------------|-------------------------|-------------------------------|---|-----|
| | | | | | Luminous Flux Typ. (lm) | Luminous Efficacy Typ. (lm/W) | | |
|  LC009D Gen 1 | 80+ | 2700 | MacAdam 2step | SPHWAHDNC25YZW2H1 | 1209 | 129 | 270mA 34.6V | |
| | | | MacAdam 3step | SPHWAHDNC25YZW3H1 | | | | |
| | | | MacAdam 2step | SPHWAHDNC25YZW2D1 | | | | |
| | | | MacAdam 3step | SPHWAHDNC25YZW3D1 | | | | |
| | | 3000 | MacAdam 2step | SPHWAHDNC25YZV2H2 | 1278 | 137 | | |
| | | | MacAdam 3step | SPHWAHDNC25YZV3H2 | | | | |
| | | | MacAdam 2step | SPHWAHDNC25YZV2D1 | | | | |
| | | | MacAdam 3step | SPHWAHDNC25YZV3D1 | | | | |
| | | 3500 | MacAdam 2step | SPHWAHDNC25YZU2H2 | 1315 | 141 | | |
| | | | MacAdam 3step | SPHWAHDNC25YZU3H2 | | | | |
| | | | MacAdam 2step | SPHWAHDNC25YZU2D1 | | | | |
| | | | MacAdam 3step | SPHWAHDNC25YZU3D1 | | | | |
| | | 4000 | MacAdam 2step | SPHWAHDNC25YZT2H2 | 1347 | 144 | | |
| | | | MacAdam 3step | SPHWAHDNC25YZT3H2 | | | | |
| | | | MacAdam 2step | SPHWAHDNC25YZT2D1 | | | | |
| | | | MacAdam 3step | SPHWAHDNC25YZT3D1 | | | | |
| | | 5000 | MacAdam 3step | SPHWAHDNC25YZR3H2 | 1357 | 145 | | |
| | | | | SPHWAHDNC25YZR3D1 | 1425 | 153 | | |
| | | 5700 | MacAdam 3step | SPHWAHDNC25YZQ3H2 | 1357 | 145 | | |
| | | | | SPHWAHDNC25YZQ3D1 | 1425 | 153 | | |
| | | 6500 | MacAdam 3step | SPHWAHDNC25YZP3H2 | 1341 | 144 | | |
| | | | | SPHWAHDNC25YZP3D1 | 1408 | 151 | | |
| | | 90+ | 2700 | MacAdam 2step | SPHWAHDNC27YZW2G8 | 1038 | | 111 |
| | | | | MacAdam 3step | SPHWAHDNC27YZW3G8 | | | |
| | MacAdam 2step | | | SPHWAHDNC27YZW2D1 | | | | |
| | MacAdam 3step | | | SPHWAHDNC27YZW3D1 | | | | |
| | 3000 | | MacAdam 2step | SPHWAHDNC27YZV2H0 | 1087 | 116 | | |
| | | | MacAdam 3step | SPHWAHDNC27YZV3H0 | | | | |
| | | | MacAdam 2step | SPHWAHDNC27YZV2D1 | | | | |
| | 3000 | | MacAdam 3step | SPHWAHDNC27YZV3D1 | 1141 | 122 | | |
| | | | MacAdam 2step | SPHWAHDNC27YZU2H0 | | | | |
| | | | MacAdam 3step | SPHWAHDNC27YZU3H0 | | | | |
| | 3500 | | MacAdam 2step | SPHWAHDNC27YZU2D1 | 1178 | 126 | | |
| | | | MacAdam 3step | SPHWAHDNC27YZU3D1 | | | | |
| | | | MacAdam 2step | SPHWAHDNC27YZT2H0 | | | | |
| | | | MacAdam 3step | SPHWAHDNC27YZT3H0 | | | | |
| 4000 | MacAdam 2step | | SPHWAHDNC27YZT2D1 | 1204 | 129 | | | |
| | MacAdam 3step | | SPHWAHDNC27YZT3D1 | | | | | |
| | MacAdam 2step | SPHWAHDNC27YZR3H1 | | | | | | |
| | MacAdam 3step | SPHWAHDNC27YZR3D1 | | | | | | |
| 5000 | MacAdam 3step | SPHWAHDNC27YZR3H1 | 1152 | 123 | | | | |
| | | SPHWAHDNC27YZR3D1 | 1210 | 130 | | | | |

D-series

Specifications

D-series

| Product | CRI | CCT (K) | Color Rank | Part Number | T _j = 85°C | | I _F (mA) V _F (V) | |
|---|---------------|---------|-------------------|-------------------|----------------------------|----------------------------------|---|-----|
| | | | | | Luminous Flux Typ. (lm) | Luminous Efficacy Typ. (lm/W) | | |
|  LC013D Gen 1 | 80+ | 2700 | MacAdam 2step | SPHWAHDND25YZW2H5 | 1589 | 128 | 360mA 34.6V | |
| | | | MacAdam 3step | SPHWAHDND25YZW3H5 | | | | |
| | | | MacAdam 2step | SPHWAHDND25YZW2D1 | | | | |
| | | | MacAdam 3step | SPHWAHDND25YZW3D1 | | | | |
| | | 3000 | MacAdam 2step | SPHWAHDND25YZV2H5 | 1673 | 134 | | |
| | | | MacAdam 3step | SPHWAHDND25YZV3H5 | | | | |
| | | | MacAdam 2step | SPHWAHDND25YZV2D1 | | | | |
| | | | MacAdam 3step | SPHWAHDND25YZV3D1 | | | | |
| | | 3500 | MacAdam 2step | SPHWAHDND25YZU2H6 | 1725 | 138 | | |
| | | | MacAdam 3step | SPHWAHDND25YZU3H6 | | | | |
| | | | MacAdam 2step | SPHWAHDND25YZU2D1 | | | | |
| | | | MacAdam 3step | SPHWAHDND25YZU3D1 | | | | |
| | | 4000 | MacAdam 2step | SPHWAHDND25YZT2H6 | 1757 | 141 | | |
| | | | MacAdam 3step | SPHWAHDND25YZT3H6 | | | | |
| | | | MacAdam 2step | SPHWAHDND25YZT2D1 | | | | |
| | | | MacAdam 3step | SPHWAHDND25YZT3D1 | | | | |
| | | 5000 | MacAdam 3step | SPHWAHDND25YZR3H6 | 1772 | 142 | | |
| | | | | SPHWAHDND25YZR3D1 | 1861 | 149 | | |
| | | 5700 | MacAdam 3step | SPHWAHDND25YZQ3H6 | 1772 | 142 | | |
| | | | | SPHWAHDND25YZQ3D1 | 1861 | 149 | | |
| | | 6500 | MacAdam 3step | SPHWAHDND25YZP3H6 | 1746 | 140 | | |
| | | | | SPHWAHDND25YZP3D1 | 1834 | 147 | | |
| | | 90+ | 2700 | MacAdam 2step | SPHWAHDND27YZW2H2 | 1359 | | 109 |
| | | | | MacAdam 3step | SPHWAHDND27YZW3H2 | | | |
| | MacAdam 2step | | | SPHWAHDND27YZW2D1 | | | | |
| | MacAdam 3step | | | SPHWAHDND27YZW3D2 | | | | |
| | 3000 | | MacAdam 2step | SPHWAHDND27YZV2H3 | 1423 | 114 | | |
| | | | MacAdam 3step | SPHWAHDND27YZV3H3 | | | | |
| | | | MacAdam 2step | SPHWAHDND27YZV2D1 | | | | |
| | 3500 | | MacAdam 3step | SPHWAHDND27YZV3D1 | 1494 | 120 | | |
| | | | MacAdam 2step | SPHWAHDND27YZU2H4 | | | | |
| | | | MacAdam 3step | SPHWAHDND27YZU3H4 | | | | |
| | 4000 | | MacAdam 2step | SPHWAHDND27YZU2D1 | 1547 | 124 | | |
| | | | MacAdam 3step | SPHWAHDND27YZU3D1 | | | | |
| | | | MacAdam 2step | SPHWAHDND27YZT2H4 | | | | |
| | | | MacAdam 3step | SPHWAHDND27YZT3H4 | | | | |
| 5000 | MacAdam 2step | | SPHWAHDND27YZT2D1 | 1580 | 127 | | | |
| | MacAdam 3step | | SPHWAHDND27YZT3D1 | | | | | |
| | MacAdam 2step | | SPHWAHDND27YZR3H4 | | | | | |
| | MacAdam 3step | | SPHWAHDND27YZR3D1 | | | | | |

| Product | CRI | CCT (K) | Color Rank | Part Number | T _j = 85°C | | I _F (mA) V _F (V) | |
|---|---------------|---------|-------------------|-------------------|----------------------------|----------------------------------|---|-----|
| | | | | | Luminous Flux Typ. (lm) | Luminous Efficacy Typ. (lm/W) | | |
|  LC016D Gen 1 | 80+ | 2700 | MacAdam 2step | SPHWAHDNE25YZW2H9 | 2065 | 133 | 450mA 34.6V | |
| | | | MacAdam 3step | SPHWAHDNE25YZW3H9 | | | | |
| | | | MacAdam 2step | SPHWAHDNE25YZW2D1 | | | | |
| | | | MacAdam 3step | SPHWAHDNE25YZW3D1 | | | | |
| | | 3000 | MacAdam 2step | SPHWAHDNE25YZV2J0 | 2182 | 140 | | |
| | | | MacAdam 3step | SPHWAHDNE25YZV3J0 | | | | |
| | | | MacAdam 2step | SPHWAHDNE25YZV2D1 | | | | |
| | | | MacAdam 3step | SPHWAHDNE25YZV3D1 | | | | |
| | | 3500 | MacAdam 2step | SPHWAHDNE25YZU2J1 | 2263 | 145 | | |
| | | | MacAdam 3step | SPHWAHDNE25YZU3J1 | | | | |
| | | | MacAdam 2step | SPHWAHDNE25YZU2D1 | | | | |
| | | | MacAdam 3step | SPHWAHDNE25YZU3D1 | | | | |
| | | 4000 | MacAdam 2step | SPHWAHDNE25YZT2J1 | 2304 | 148 | | |
| | | | MacAdam 3step | SPHWAHDNE25YZT3J1 | | | | |
| | | | MacAdam 2step | SPHWAHDNE25YZT2D1 | | | | |
| | | | MacAdam 3step | SPHWAHDNE25YZT3D1 | | | | |
| | | 5000 | MacAdam 3step | SPHWAHDNE25YZR3J2 | 2324 | 149 | | |
| | | | | SPHWAHDNE25YZR3D1 | 2440 | 157 | | |
| | | 5700 | MacAdam 3step | SPHWAHDNE25YZQ3J2 | 2324 | 149 | | |
| | | | | SPHWAHDNE25YZQ3D1 | 2440 | 157 | | |
| | | 6500 | MacAdam 3step | SPHWAHDNE25YZP3J1 | 2304 | 148 | | |
| | | | | SPHWAHDNE25YZP3D1 | 2419 | 155 | | |
| | | 90+ | 2700 | MacAdam 2step | SPHWAHDNE27YZW2H6 | 1771 | | 114 |
| | | | | MacAdam 3step | SPHWAHDNE27YZW3H6 | | | |
| | MacAdam 2step | | | SPHWAHDNE27YZW2D1 | | | | |
| | MacAdam 3step | | | SPHWAHDNE27YZW3D1 | | | | |
| | 3000 | | MacAdam 2step | SPHWAHDNE27YZV2H7 | 1877 | 121 | | |
| | | | MacAdam 3step | SPHWAHDNE27YZV3H7 | | | | |
| | | | MacAdam 2step | SPHWAHDNE27YZV2D1 | | | | |
| | 3500 | | MacAdam 3step | SPHWAHDNE27YZV3D1 | 1970 | 127 | | |
| | | | MacAdam 2step | SPHWAHDNE27YZU2H8 | | | | |
| | | | MacAdam 3step | SPHWAHDNE27YZU3H8 | | | | |
| | 4000 | | MacAdam 2step | SPHWAHDNE27YZU2D1 | 2029 | 130 | | |
| | | | MacAdam 3step | SPHWAHDNE27YZU3D1 | | | | |
| | | | MacAdam 2step | SPHWAHDNE27YZT2H8 | | | | |
| | | | MacAdam 3step | SPHWAHDNE27YZT3H8 | | | | |
| 5000 | MacAdam 2step | | SPHWAHDNE27YZT2D1 | 2069 | 133 | | | |
| | MacAdam 3step | | SPHWAHDNE27YZT3D1 | | | | | |
| | MacAdam 2step | | SPHWAHDNE27YZR3H8 | | | | | |
| | MacAdam 3step | | SPHWAHDNE27YZR3D1 | | | | | |

D-series

Specifications

D-series

| Product | CRI | CCT (K) | Color Rank | Part Number | T _j = 85°C | | I _F (mA) V _F (V) | | | |
|---|-------------------|-------------------|-------------------|-------------------|-------------------------|-------------------------------|---|------|------|-----|
| | | | | | Luminous Flux Typ. (lm) | Luminous Efficacy Typ. (lm/W) | | | | |
|  LC019D Gen 1 | 80+ | 2700 | MacAdam 2step | SPHWAHDNF25YZW2J3 | 2458 | 132 | 540mA 34.6V | | | |
| | | | MacAdam 3step | SPHWAHDNF25YZW3J3 | | | | | | |
| | | | MacAdam 2step | SPHWAHDNF25YZW2D1 | | | | 2581 | 138 | |
| | | | MacAdam 3step | SPHWAHDNF25YZW3D1 | | | | | | |
| | | 3000 | MacAdam 2step | SPHWAHDNF25YZV24 | 2592 | 139 | | | | |
| | | | MacAdam 3step | SPHWAHDNF25YZV3J4 | | | | | | |
| | | | MacAdam 2step | SPHWAHDNF25YZV2D1 | | | | 2722 | 146 | |
| | | | MacAdam 3step | SPHWAHDNF25YZV3D1 | | | | | | |
| | | 3500 | MacAdam 2step | SPHWAHDNF25YZU25 | 2672 | 143 | | | | |
| | | | MacAdam 3step | SPHWAHDNF25YZU3J5 | | | | | | |
| | | | MacAdam 2step | SPHWAHDNF25YZU2D1 | | | | 2805 | 150 | |
| | | | MacAdam 3step | SPHWAHDNF25YZU3D1 | | | | | | |
| | | 4000 | MacAdam 2step | SPHWAHDNF25YZT25 | 2726 | 146 | | | | |
| | | | MacAdam 3step | SPHWAHDNF25YZT3J5 | | | | | | |
| | | | MacAdam 2step | SPHWAHDNF25YZT2D1 | | | | 2863 | 153 | |
| | | | MacAdam 3step | SPHWAHDNF25YZT3D1 | | | | | | |
| | | 5000 | MacAdam 3step | SPHWAHDNF25YZR3J6 | 2756 | 148 | | | | |
| | | | | SPHWAHDNF25YZR3D1 | 2894 | 155 | | | | |
| | | 5700 | MacAdam 3step | SPHWAHDNF25YZQ3J6 | 2756 | 148 | | | | |
| | | | | SPHWAHDNF25YZQ3D1 | 2894 | 155 | | | | |
| | | 6500 | MacAdam 3step | SPHWAHDNF25YZP3J5 | 2726 | 146 | | | | |
| | | | | SPHWAHDNF25YZP3D1 | 2863 | 153 | | | | |
| | | 90+ | 2700 | MacAdam 2step | SPHWAHDNF27YZW2H9 | 2104 | | 113 | | |
| | | | | MacAdam 3step | SPHWAHDNF27YZW3H9 | | | | | |
| | | | | MacAdam 2step | SPHWAHDNF27YZW2D1 | | | | 2210 | 118 |
| | | | | MacAdam 3step | SPHWAHDNF27YZW3D1 | | | | | |
| | | | 3000 | MacAdam 2step | SPHWAHDNF27YZV2J0 | 2207 | | 118 | | |
| | | | | MacAdam 3step | SPHWAHDNF27YZV3J0 | | | | | |
| MacAdam 2step | SPHWAHDNF27YZV2D1 | | | 2317 | 124 | | | | | |
| MacAdam 3step | SPHWAHDNF27YZV3D1 | | | | | | | | | |
| 3500 | MacAdam 2step | | SPHWAHDNF27YZU2J1 | 2287 | 122 | | | | | |
| | MacAdam 3step | | SPHWAHDNF27YZU3J1 | | | | | | | |
| | MacAdam 2step | | SPHWAHDNF27YZU2D1 | | | 2402 | 129 | | | |
| | MacAdam 3step | | SPHWAHDNF27YZU3D1 | | | | | | | |
| 4000 | MacAdam 2step | | SPHWAHDNF27YZT2J2 | 2337 | 125 | | | | | |
| | MacAdam 3step | | SPHWAHDNF27YZT3J2 | | | | | | | |
| | MacAdam 2step | | SPHWAHDNF27YZT2D1 | | | 2454 | 131 | | | |
| | MacAdam 3step | | SPHWAHDNF27YZT3D1 | | | | | | | |
| 5000 | MacAdam 3step | SPHWAHDNG27YZR3J8 | 2339 | 125 | | | | | | |
| | | SPHWAHDNG27YZR3D1 | 2456 | 131 | | | | | | |

| Product | CRI | CCT (K) | Color Rank | Part Number | T _j = 85°C | | I _F (mA) V _F (V) | | | |
|---|-------------------|-------------------|-------------------|-------------------|-------------------------|-------------------------------|---|------|------|-----|
| | | | | | Luminous Flux Typ. (lm) | Luminous Efficacy Typ. (lm/W) | | | | |
|  LC026D Gen 1 | 80+ | 2700 | MacAdam 2step | SPHWAHDNK25YZW2M7 | 3225 | 129 | 720mA 34.6V | | | |
| | | | MacAdam 3step | SPHWAHDNK25YZW3M7 | | | | | | |
| | | | MacAdam 2step | SPHWAHDNK25YZW2D1 | | | | 3386 | 136 | |
| | | | MacAdam 3step | SPHWAHDNK25YZW3D1 | | | | | | |
| | | 3000 | MacAdam 2step | SPHWAHDNK25YZV2M9 | 3389 | 136 | | | | |
| | | | MacAdam 3step | SPHWAHDNK25YZV3M9 | | | | | | |
| | | | MacAdam 2step | SPHWAHDNK25YZV2D1 | | | | 3558 | 143 | |
| | | | MacAdam 3step | SPHWAHDNK25YZV3D1 | | | | | | |
| | | 3500 | MacAdam 2step | SPHWAHDNK25YZU2N1 | 3488 | 140 | | | | |
| | | | MacAdam 3step | SPHWAHDNK25YZU3N1 | | | | | | |
| | | | MacAdam 2step | SPHWAHDNK25YZU2D1 | | | | 3663 | 147 | |
| | | | MacAdam 3step | SPHWAHDNK25YZU3D1 | | | | | | |
| | | 4000 | MacAdam 2step | SPHWAHDNK25YZT2N2 | 3558 | 143 | | | | |
| | | | MacAdam 3step | SPHWAHDNK25YZT3N2 | | | | | | |
| | | | MacAdam 2step | SPHWAHDNK25YZT2D1 | | | | 3736 | 150 | |
| | | | MacAdam 3step | SPHWAHDNK25YZT3D1 | | | | | | |
| | | 5000 | MacAdam 3step | SPHWAHDNK25YZR3N2 | 3588 | 144 | | | | |
| | | | | SPHWAHDNK25YZR3D1 | 3767 | 151 | | | | |
| | | 5700 | MacAdam 3step | SPHWAHDNK25YZQ3N3 | 3588 | 144 | | | | |
| | | | | SPHWAHDNK25YZQ3D1 | 3767 | 151 | | | | |
| | | 6500 | MacAdam 3step | SPHWAHDNK25YZP3N2 | 3558 | 143 | | | | |
| | | | | SPHWAHDNK25YZP3D1 | 3736 | 150 | | | | |
| | | 90+ | 2700 | MacAdam 2step | SPHWAHDNK27YZW2M0 | 2760 | | 111 | | |
| | | | | MacAdam 3step | SPHWAHDNK27YZW3M0 | | | | | |
| | | | | MacAdam 2step | SPHWAHDNK27YZW2D1 | | | | 2898 | 116 |
| | | | | MacAdam 3step | SPHWAHDNK27YZW3D1 | | | | | |
| | | | 3000 | MacAdam 2step | SPHWAHDNK27YZV2M2 | 2903 | | 117 | | |
| | | | | MacAdam 3step | SPHWAHDNK27YZV3M2 | | | | | |
| MacAdam 2step | SPHWAHDNK27YZV2D1 | | | 3048 | 122 | | | | | |
| MacAdam 3step | SPHWAHDNK27YZV3D1 | | | | | | | | | |
| 3500 | MacAdam 2step | | SPHWAHDNK27YZU2M4 | 2990 | 120 | | | | | |
| | MacAdam 3step | | SPHWAHDNK27YZU3M4 | | | | | | | |
| | MacAdam 2step | | SPHWAHDNK27YZU2D1 | | | 3139 | 126 | | | |
| | MacAdam 3step | | SPHWAHDNK27YZU3D1 | | | | | | | |
| 4000 | MacAdam 2step | | SPHWAHDNK27YZT2M5 | 3051 | 122 | | | | | |
| | MacAdam 3step | | SPHWAHDNK27YZT3M5 | | | | | | | |
| | MacAdam 2step | | SPHWAHDNK27YZT2D1 | | | 3204 | 129 | | | |
| | MacAdam 3step | | SPHWAHDNK27YZT3D1 | | | | | | | |
| 5000 | MacAdam 3step | SPHWAHDNK27YZR3M5 | 3077 | 124 | | | | | | |
| | | SPHWAHDNK27YZR3D1 | 3231 | 130 | | | | | | |

D-series

Specifications

D-series

| Product | CRI | CCT (K) | Color Rank | Part Number | T _j = 85°C | | I _F (mA) V _F (V) |
|---|------|---------------|-------------------|-------------------|-------------------------|-------------------------------|---|
| | | | | | Luminous Flux Typ. (lm) | Luminous Efficacy Typ. (lm/W) | |
|  LC040D Gen 1 | 80+ | 2700 | MacAdam 2step | SPHWAHDNG25YZW2K0 | 4996 | 134 | 1080mA 34.6V |
| | | | MacAdam 3step | SPHWAHDNG25YZW3K0 | | | |
| | | | MacAdam 2step | SPHWAHDNG25YZW2D1 | | | |
| | | | MacAdam 3step | SPHWAHDNG25YZW3D1 | | | |
| | | 3000 | MacAdam 2step | SPHWAHDNG25YZV2K2 | 5257 | 141 | |
| | | | MacAdam 3step | SPHWAHDNG25YZV3K2 | | | |
| | | | MacAdam 2step | SPHWAHDNG25YZV2D1 | | | |
| | | | MacAdam 3step | SPHWAHDNG25YZV3D1 | | | |
| | | 3500 | MacAdam 2step | SPHWAHDNG25YZU2K3 | 5418 | 145 | |
| | | | MacAdam 3step | SPHWAHDNG25YZU3K3 | | | |
| | | | MacAdam 2step | SPHWAHDNG25YZU2D1 | | | |
| | | | MacAdam 3step | SPHWAHDNG25YZU3D1 | | | |
| | 4000 | MacAdam 2step | SPHWAHDNG25YZT2K3 | 5535 | 148 | | |
| | | MacAdam 3step | SPHWAHDNG25YZT3K3 | | | | |
| | | MacAdam 2step | SPHWAHDNG25YZT2D1 | | | | |
| | | MacAdam 3step | SPHWAHDNG25YZT3D1 | | | | |
| | 5000 | MacAdam 3step | SPHWAHDNG25YZR3K4 | 5561 | 149 | | |
| | | | SPHWAHDNG25YZR3D1 | 5839 | 156 | | |
| | 5700 | MacAdam 3step | SPHWAHDNG25YZQ3K4 | 5588 | 150 | | |
| | | | SPHWAHDNG25YZQ3D1 | 5868 | 157 | | |
| | 6500 | MacAdam 3step | SPHWAHDNG25YZP3K3 | 5528 | 148 | | |
| | | | SPHWAHDNG25YZP3D1 | 5804 | 155 | | |
| | 90+ | 2700 | MacAdam 2step | SPHWAHDNG27YZW2J6 | 4283 | 115 | |
| | | | MacAdam 3step | SPHWAHDNG27YZW3J6 | | | |
| | | | MacAdam 2step | SPHWAHDNG27YZW2D1 | | | |
| | | | MacAdam 3step | SPHWAHDNG27YZW3D1 | | | |
| | | | MacAdam 2step | SPHWAHDNG27YZV2J7 | | | |
| | | | MacAdam 3step | SPHWAHDNG27YZV3J7 | | | |
| | | 3000 | MacAdam 2step | SPHWAHDNG27YZV2D1 | 4751 | 127 | |
| | | | MacAdam 3step | SPHWAHDNG27YZV3D1 | | | |
| MacAdam 2step | | | SPHWAHDNG27YZU2J8 | | | | |
| 3500 | | MacAdam 3step | SPHWAHDNG27YZU3J8 | 4640 | 124 | | |
| | | MacAdam 2step | SPHWAHDNG27YZU2D1 | | | | |
| | | MacAdam 3step | SPHWAHDNG27YZU3D1 | | | | |
| 4000 | | MacAdam 2step | SPHWAHDNG27YZT2J8 | 4742 | 127 | | |
| | | MacAdam 3step | SPHWAHDNG27YZT3J8 | | | | |
| | | MacAdam 2step | SPHWAHDNG27YZT2D1 | | | | |
| | | MacAdam 3step | SPHWAHDNG27YZT3D1 | | | | |
| 5000 | | MacAdam 3step | SPHWAHDNG27YZR3J8 | 4796 | 128 | | |
| | | | SPHWAHDNG27YZR3D1 | 5036 | 135 | | |

| Product | CRI | CCT (K) | Color Rank | Part Number | T _j = 85°C | | I _F (mA) V _F (V) |
|---|---------------|-------------------|-------------------|-------------------|-------------------------|-------------------------------|---|
| | | | | | Luminous Flux Typ. (lm) | Luminous Efficacy Typ. (lm/W) | |
|  LC060D Gen 1 | 70+ | 3000 | MacAdam 3step | SPHWAHDNL231ZV3Q8 | 8284 | 148 | 1080mA 52V |
| | | 4000 | MacAdam 3step | SPHWAHDNL231ZT3R1 | 8550 | 152 | |
| | | 5000 | MacAdam 3step | SPHWAHDNL231ZR3R2 | 8683 | 155 | |
| | 80+ | 2700 | MacAdam 2step | SPHWAHDNL251ZW2P9 | 7277 | 130 | |
| | | | MacAdam 3step | SPHWAHDNL251ZW3P9 | | | |
| | | 3000 | MacAdam 2step | SPHWAHDNL251ZV2Q3 | 7667 | 137 | |
| | | | MacAdam 3step | SPHWAHDNL251ZV3Q3 | | | |
| | | 3500 | MacAdam 2step | SPHWAHDNL251ZU2Q5 | 7904 | 141 | |
| | | | MacAdam 3step | SPHWAHDNL251ZU3Q5 | | | |
| | 4000 | MacAdam 2step | SPHWAHDNL251ZT2Q6 | 8075 | 144 | | |
| | | MacAdam 3step | SPHWAHDNL251ZT3Q6 | | | | |
| | | 5000 | MacAdam 3step | | | SPHWAHDNL251ZR3Q7 | |
| 5700 | | MacAdam 3step | SPHWAHDNL251ZQ3Q7 | | | | |
| 6500 | MacAdam 3step | SPHWAHDNL271ZP3Q6 | 8066 | 144 | | | |
| | | SPHWAHDNL271ZP3Q6 | 8066 | 144 | | | |
|  LC080D Gen 1 | 70+ | 3000 | MacAdam 3step | SPHWAHDNM231ZV3U5 | 12084 | 143 | 1620mA 52V |
| | | 4000 | MacAdam 3step | SPHWAHDNM231ZT3U9 | 12483 | 148 | |
| | | 5000 | MacAdam 3step | SPHWAHDNM231ZR3V0 | 12673 | 150 | |
| | 80+ | 2700 | MacAdam 2step | SPHWAHDNM251ZW2T1 | 10612 | 126 | |
| | | | MacAdam 3step | SPHWAHDNM251ZW3T1 | | | |
| | | 3000 | MacAdam 2step | SPHWAHDNM251ZV2T6 | 11201 | 133 | |
| | | | MacAdam 3step | SPHWAHDNM251ZV3T6 | | | |
| | | 3500 | MacAdam 2step | SPHWAHDNM251ZU2T9 | 11533 | 137 | |
| | | | MacAdam 3step | SPHWAHDNM251ZU3T9 | | | |
| | | 4000 | MacAdam 2step | SPHWAHDNM251ZT2U2 | 11780 | 140 | |
| | | | MacAdam 3step | SPHWAHDNM251ZT3U2 | | | |
| | | 5000 | MacAdam 3step | SPHWAHDNM251ZR3U2 | 11847 | 141 | |
| | | 5700 | MacAdam 3step | SPHWAHDNM251ZQ3V0 | 11904 | 141 | |
| | | 6500 | MacAdam 3step | SPHWAHDNM251ZP3V5 | 11723 | 139 | |

D-series

C-Series

Make Your Business Shine

High-intensity small LES for powerfully effective retail lighting

C-series with High Intensity

Smaller LES, high intensity, higher CBCP

High lumen density COB



Standard COB



C-Series

C-series Gen 2 [Small LES COB]



| T _j =85°C | LC010C Gen 2 | LC020C Gen 2 | LC030C Gen 2 | LC040C Gen 2 |
|----------------------|------------------|------------------|-------------------|-------------------|
| LES | 6.0mm | 8.5mm | 11.5mm | |
| Typical | 35.0V | | | |
| | 10.5W (300mA) | 21.0W (600mA) | 31.5W (900mA) | 36.8W (1050mA) |
| Max. | 13.8W (380mA) | 34.0W (920mA) | 51.1W (1380mA) | 59.5W (1610mA) |
| Size | 13.5mm x 13.5mm | 19mm x 19mm | 19mm x 19mm | |



Color Variation

| Product | CRI90+ | | | | | CRI80+ | | | | |
|----------------|--------|-------|-------|-------|-------|--------|-------|-------|-------|-------|
| | 2700K | 3000K | 3500K | 4000K | 5000K | 2700K | 3000K | 3500K | 4000K | 5000K |
| LC010C Gen 2 | o | o | o | o | o | o | o | o | o | o |
| LC020C Gen 2 | o | o | o | o | o | o | o | o | o | o |
| LC030C Gen 2 | o | o | o | o | o | o | o | o | o | o |
| LC040C Gen 2 | o | o | o | o | o | o | o | o | o | o |
| MacAdam 3-Step | o | o | o | o | o | o | o | o | o | o |

Specifications

| Product | CRI | CCT (K) | Color Rank | Part Number | T _j = 85°C | | I _F (mA) V _F (V) |
|---|-----|---------|---------------|-------------------|----------------------------|----------------------------------|---|
| | | | | | Luminous Flux Typ. (lm) | Luminous Efficacy Typ. (lm/W) | |
|  LC010C Gen 2 | 80+ | 2700 | MacAdam 3step | SPHWAHDNC25YZW3C2 | 1212 | 115 | 300mA 35.0V |
| | | 3000 | MacAdam 3step | SPHWAHDNC25YZV3C2 | 1274 | 121 | |
| | | 3500 | MacAdam 3step | SPHWAHDNC25YZU3C2 | 1311 | 125 | |
| | | 4000 | MacAdam 3step | SPHWAHDNC25YZT3C2 | 1337 | 127 | |
| | | 5000 | MacAdam 3step | SPHWAHDNC25YZR3C2 | 1348 | 128 | |
| | 90+ | 2700 | MacAdam 3step | SPHWAHDNC27YZW3C2 | 1037 | 99 | |
| | | 3000 | MacAdam 3step | SPHWAHDNC27YZV3C2 | 1091 | 104 | |
| | | 3500 | MacAdam 3step | SPHWAHDNC27YZU3C2 | 1123 | 107 | |
| | | 4000 | MacAdam 3step | SPHWAHDNC27YZT3C2 | 1147 | 109 | |
| | | 5000 | MacAdam 3step | SPHWAHDNC27YZR3C2 | 1156 | 110 | |

Specifications

| Product | CRI | CCT (K) | Color Rank | Part Number | T _j = 85°C | | I _F (mA) V _F (V) |
|---|-----|---------|---------------|-------------------|----------------------------|----------------------------------|---|
| | | | | | Luminous Flux Typ. (lm) | Luminous Efficacy Typ. (lm/W) | |
|  LC020C Gen 2 | 80+ | 2700 | MacAdam 3step | SPHWAHDNF25YZW3C2 | 2485 | 118 | 600mA 35.0V |
| | | 3000 | MacAdam 3step | SPHWAHDNF25YZV3C2 | 2625 | 125 | |
| | | 3500 | MacAdam 3step | SPHWAHDNF25YZU3C2 | 2688 | 128 | |
| | | 4000 | MacAdam 3step | SPHWAHDNF25YZT3C2 | 2742 | 131 | |
| | | 5000 | MacAdam 3step | SPHWAHDNF25YZR3C2 | 2765 | 132 | |
| | 90+ | 2700 | MacAdam 3step | SPHWAHDNF27YZW3C2 | 2127 | 101 | |
| | | 3000 | MacAdam 3step | SPHWAHDNF27YZV3C2 | 2237 | 107 | |
| | | 3500 | MacAdam 3step | SPHWAHDNF27YZU3C2 | 2304 | 110 | |
| | | 4000 | MacAdam 3step | SPHWAHDNF27YZT3C2 | 2351 | 112 | |
| | | 5000 | MacAdam 3step | SPHWAHDNF27YZR3C2 | 2372 | 113 | |
|  LC030C Gen 2 | 80+ | 2700 | MacAdam 3step | SPHWAHDNH25YZW3C2 | 3765 | 120 | 900mA 35.0V |
| | | 3000 | MacAdam 3step | SPHWAHDNH25YZV3C2 | 3956 | 126 | |
| | | 3500 | MacAdam 3step | SPHWAHDNH25YZU3C2 | 4072 | 129 | |
| | | 4000 | MacAdam 3step | SPHWAHDNH25YZT3C2 | 4154 | 132 | |
| | | 5000 | MacAdam 3step | SPHWAHDNH25YZR3C2 | 4188 | 133 | |
| | 90+ | 2700 | MacAdam 3step | SPHWAHDNH27YZW3C2 | 3222 | 102 | |
| | | 3000 | MacAdam 3step | SPHWAHDNH27YZV3C2 | 3389 | 108 | |
| | | 3500 | MacAdam 3step | SPHWAHDNH27YZU3C2 | 3490 | 111 | |
| | | 4000 | MacAdam 3step | SPHWAHDNH27YZT3C2 | 3562 | 113 | |
| | | 5000 | MacAdam 3step | SPHWAHDNH27YZR3C2 | 3592 | 114 | |
|  LC040C Gen 2 | 80+ | 2700 | MacAdam 3step | SPHWAHDNK25YZW3C2 | 4305 | 117 | 1050mA 35.0V |
| | | 3000 | MacAdam 3step | SPHWAHDNK25YZV3C2 | 4524 | 123 | |
| | | 3500 | MacAdam 3step | SPHWAHDNK25YZU3C2 | 4657 | 127 | |
| | | 4000 | MacAdam 3step | SPHWAHDNK25YZT3C2 | 4750 | 129 | |
| | | 5000 | MacAdam 3step | SPHWAHDNK25YZR3C2 | 4790 | 130 | |
| | 90+ | 2700 | MacAdam 3step | SPHWAHDNK27YZW3C2 | 3684 | 100 | |
| | | 3000 | MacAdam 3step | SPHWAHDNK27YZV3C2 | 3875 | 105 | |
| | | 3500 | MacAdam 3step | SPHWAHDNK27YZU3C2 | 3991 | 109 | |
| | | 4000 | MacAdam 3step | SPHWAHDNK27YZT3C2 | 4073 | 111 | |
| | | 5000 | MacAdam 3step | SPHWAHDNK27YZR3C2 | 4108 | 112 | |

R-Series

Enriched Colors for Displaying

Vividly enhanced premium colors, contrast and exceptional white light



R-series with Specialized Spectrum

Enhanced color appearance based on color gamut and preference survey

Fashion Vivid Color

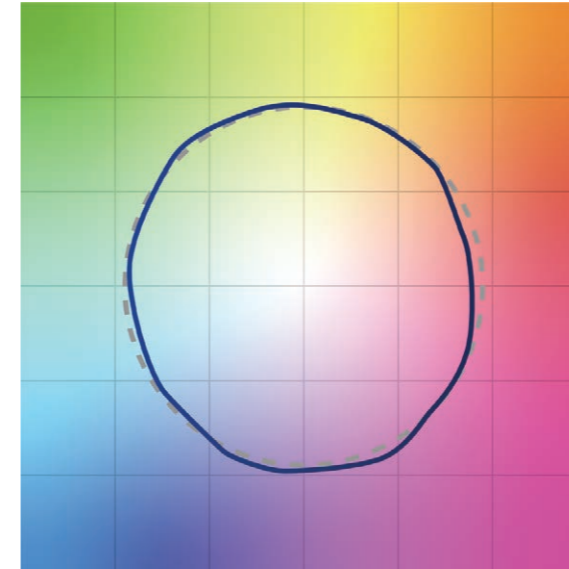

— Fashion Vivid Color LED - - - Color Standard by TM 30

Enhanced whiteness and vividness by diminishing of yellowish

Fashion Vivid White

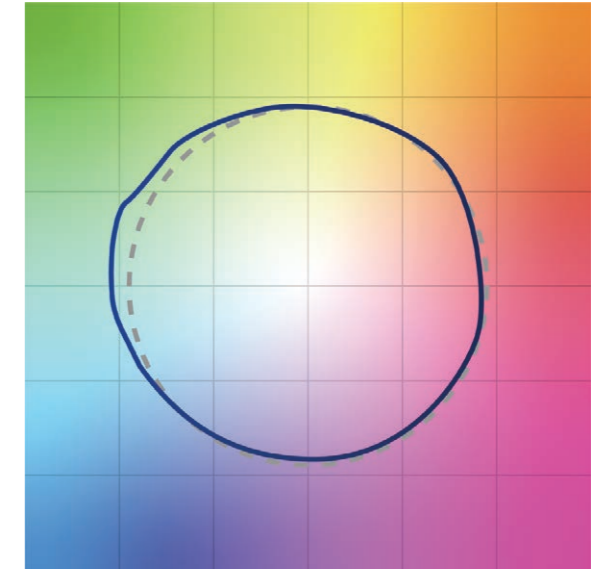

— Fashion Vivid White LED - - - Color Standard by TM 30

Emphasizing whiteness by adjusting color point below blackbody locus

Meat

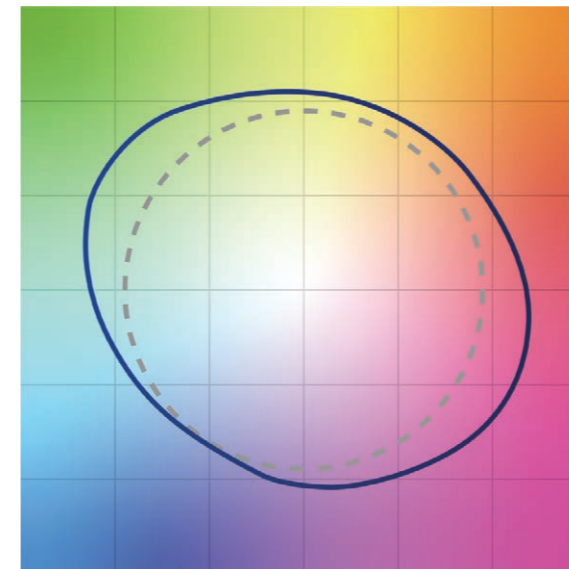

— Meat LED - - - Color Standard by TM 30

Enhanced whiteness and reddish color by using longer 650nm red phosphors

Vegetable

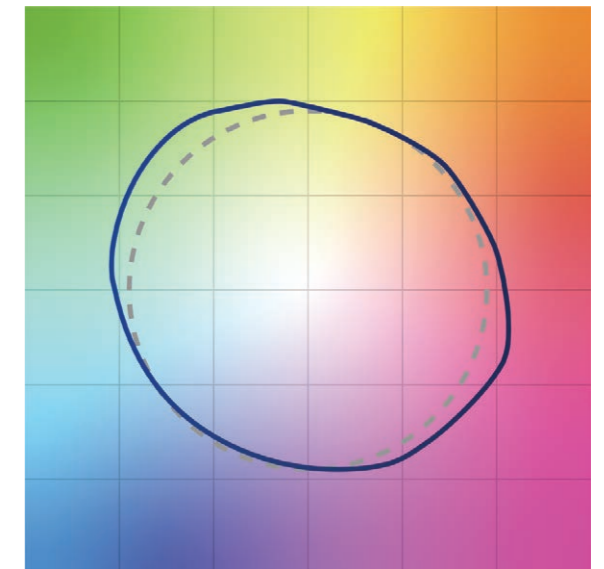

— Vegetable LED - - - Color Standard by TM 30

Fresh greenish color based on preference survey of 300 persons

R-series Fashion



| T _j =85°C | LC013R Fashion | LC016R Fashion | LC019R Fashion | LC026R Fashion | LC033R Fashion | LC040R Fashion |
|----------------------|-----------------|----------------|----------------|----------------|----------------|----------------|
| LES | 9.8mm | | 14.5mm | | | 22mm |
| Typical | 34.6V | | | | | |
| | 12.5W | 15.6W | 18.7W | 24.9W | 31.1W | 37.4W |
| | 360mA | 450mA | 540mA | 720mA | 900mA | 1080mA |
| Max. | 34.5W | 43.1W | 51.8W | 69.0W | 86.2W | 103.5W |
| | 920mA | 1150mA | 1380mA | 1840mA | 2300mA | 2760mA |
| Size | 13.5mm x 13.5mm | | 19mm x 19mm | | | 28mm x 28mm |

Specifications

| Product | CRI | CCT (K) | Color Rank | Part Number | T _j = 85°C | | I _F (mA) V _F (V) |
|-------------------------------|-----|------------------|---------------|-------------------|-------------------------|-------------------------------|---|
| | | | | | Luminous Flux Typ. (lm) | Luminous Efficacy Typ. (lm/W) | |
| LC013R Fashion Vivid White | 90+ | 3000 (Below BBL) | MacAdam 3step | SPHWAHDND2VYZVND2 | 1435 | 115 | 360mA 34.6V |
| | | 3500 (Below BBL) | MacAdam 3step | SPHWAHDND2VYZUND2 | 1494 | 120 | |
| | | 4000 (Below BBL) | MacAdam 3step | SPHWAHDND2VYZTND2 | 1541 | 124 | |
| LC016R Fashion Vivid White | 90+ | 3000 (Below BBL) | MacAdam 3step | SPHWAHDNE2VYZVND2 | 1837 | 118 | 450mA 34.6V |
| | | 3500 (Below BBL) | MacAdam 3step | SPHWAHDNE2VYZUND2 | 1912 | 123 | |
| | | 4000 (Below BBL) | MacAdam 3step | SPHWAHDNE2VYZTND2 | 1972 | 127 | |
| LC019R Fashion Vivid White | 90+ | 3000 (Below BBL) | MacAdam 3step | SPHWAHDNF2VYZVND2 | 2195 | 117 | 540mA 34.6V |
| | | 3500 (Below BBL) | MacAdam 3step | SPHWAHDNF2VYZUND2 | 2284 | 122 | |
| | | 4000 (Below BBL) | MacAdam 3step | SPHWAHDNF2VYZTND2 | 2355 | 126 | |
| LC026R Fashion Vivid White | 90+ | 3000 (Below BBL) | MacAdam 3step | SPHWAHDNG2VYZVND2 | 2917 | 117 | 720mA 34.6V |
| | | 3500 (Below BBL) | MacAdam 3step | SPHWAHDNG2VYZUND2 | 3036 | 122 | |
| | | 4000 (Below BBL) | MacAdam 3step | SPHWAHDNG2VYZTND2 | 3131 | 126 | |

Specifications

| Product | CCT (K) | Color Rank | Part Number | T _j = 85°C | | I _F (mA) V _F (V) |
|-------------------------------|------------------|-------------------|-------------------|-------------------------|-------------------------------|---|
| | | | | Luminous Flux Typ. (lm) | Luminous Efficacy Typ. (lm/W) | |
| LC013R Fashion Vivid Color | 3000 (Below BBL) | MacAdam 2step | SPHWAHDND2VYZV2D2 | 1334 | 107 | 360mA 34.6V |
| | | MacAdam 3step | SPHWAHDND2VYZVVD2 | | | |
| | 3300 (Below BBL) | MacAdam 2step | SPHWAHDND2VYZA2D2 | 1394 | 112 | |
| | | MacAdam 3step | SPHWAHDND2VYZAVD2 | | | |
| | 3500 (Below BBL) | MacAdam 2step | SPHWAHDND2VYZU2D2 | 1433 | 115 | |
| | | MacAdam 3step | SPHWAHDND2VYZUVD2 | | | |
| 4000 (Below BBL) | MacAdam 2step | SPHWAHDND2VYZT2D2 | 1533 | 123 | | |
| | MacAdam 3step | SPHWAHDND2VYZTVD2 | | | | |
| LC016R Fashion Vivid Color | 3000 (Below BBL) | MacAdam 2step | SPHWAHDNE2VYZV2D2 | 1745 | 112 | 450mA 34.6V |
| | | MacAdam 3step | SPHWAHDNE2VYZVVD2 | | | |
| | 3300 (Below BBL) | MacAdam 2step | SPHWAHDNE2VYZA2D2 | 1823 | 117 | |
| | | MacAdam 3step | SPHWAHDNE2VYZAVD2 | | | |
| | 3500 (Below BBL) | MacAdam 2step | SPHWAHDNE2VYZU2D2 | 1875 | 120 | |
| | | MacAdam 3step | SPHWAHDNE2VYZUVD2 | | | |
| 4000 (Below BBL) | MacAdam 2step | SPHWAHDNE2VYZT2D2 | 2005 | 129 | | |
| | MacAdam 3step | SPHWAHDNE2VYZTVD2 | | | | |
| LC019R Fashion Vivid Color | 3000 (Below BBL) | MacAdam 2step | SPHWAHDNF2VYZV2D2 | 2068 | 111 | 540mA 34.6V |
| | | MacAdam 3step | SPHWAHDNF2VYZVVD2 | | | |
| | 3300 (Below BBL) | MacAdam 2step | SPHWAHDNF2VYZA2D2 | 2160 | 116 | |
| | | MacAdam 3step | SPHWAHDNF2VYZAVD2 | | | |
| | 3500 (Below BBL) | MacAdam 2step | SPHWAHDNF2VYZU2D2 | 2222 | 119 | |
| | | MacAdam 3step | SPHWAHDNF2VYZUVD2 | | | |
| 4000 (Below BBL) | MacAdam 2step | SPHWAHDNF2VYZT2D2 | 2376 | 127 | | |
| | MacAdam 3step | SPHWAHDNF2VYZTVD2 | | | | |
| LC026R Fashion Vivid Color | 3000 (Below BBL) | MacAdam 2step | SPHWAHDNG2VYZV2D2 | 2706 | 109 | 720mA 34.6V |
| | | MacAdam 3step | SPHWAHDNG2VYZVVD2 | | | |
| | 3300 (Below BBL) | MacAdam 2step | SPHWAHDNG2VYZA2D2 | 2827 | 113 | |
| | | MacAdam 3step | SPHWAHDNG2VYZAVD2 | | | |
| | 3500 (Below BBL) | MacAdam 2step | SPHWAHDNG2VYZU2D2 | 2907 | 117 | |
| | | MacAdam 3step | SPHWAHDNG2VYZUVD2 | | | |
| 4000 (Below BBL) | MacAdam 2step | SPHWAHDNG2VYZT2D2 | 3108 | 125 | | |
| | MacAdam 3step | SPHWAHDNG2VYZTVD2 | | | | |
| LC033R Fashion Vivid Color | 3000 (Below BBL) | MacAdam 2step | SPHWAHDNH2VYZV2D2 | 3339 | 107 | 900mA 34.6V |
| | | MacAdam 3step | SPHWAHDNH2VYZVVD2 | | | |
| | 3300 (Below BBL) | MacAdam 2step | SPHWAHDNH2VYZA2D2 | 3488 | 112 | |
| | | MacAdam 3step | SPHWAHDNH2VYZAVD2 | | | |
| | 3500 (Below BBL) | MacAdam 2step | SPHWAHDNH2VYZU2D2 | 3588 | 115 | |
| | | MacAdam 3step | SPHWAHDNH2VYZUVD2 | | | |
| 4000 (Below BBL) | MacAdam 2step | SPHWAHDNH2VYZT2D2 | 3836 | 123 | | |
| | MacAdam 3step | SPHWAHDNH2VYZTVD2 | | | | |
| LC040R Fashion Vivid Color | 3000 (Below BBL) | MacAdam 2step | SPHWAHDNK2VYZV2D2 | 4150 | 111 | 1080mA 34.6V |
| | | MacAdam 3step | SPHWAHDNK2VYZVVD2 | | | |
| | 3300 (Below BBL) | MacAdam 2step | SPHWAHDNK2VYZA2D2 | 4335 | 116 | |
| | | MacAdam 3step | SPHWAHDNK2VYZAVD2 | | | |
| | 3500 (Below BBL) | MacAdam 2step | SPHWAHDNK2VYZU2D2 | 4459 | 119 | |
| | | MacAdam 3step | SPHWAHDNK2VYZUVD2 | | | |
| 4000 (Below BBL) | MacAdam 2step | SPHWAHDNK2VYZT2D2 | 4768 | 128 | | |
| | MacAdam 3step | SPHWAHDNK2VYZTVD2 | | | | |

R-series Meat



| T _j =85°C | LC013R Meat | LC016R Meat | LC019R Meat | LC026R Meat | LC033R Meat |
|----------------------|-----------------|-------------|-------------|-------------|-------------|
| LES | 9.8mm | 14.5mm | | | |
| Typical | 34.6V | | | | |
| | 12.5W | 15.6W | 18.7W | 24.9W | 31.1W |
| | 360mA | 450mA | 540mA | 720mA | 900mA |
| Max. | 34.5W | 43.1W | 51.8W | 69.0W | 86.2W |
| | 920mA | 1150mA | 1380mA | 1840mA | 2300mA |
| Size | 13.5mm x 13.5mm | 19mm x 19mm | | | |

R-series Vegetable



| T _j =85°C | LC013R Vegetable | LC016R Vegetable | LC019R Vegetable | LC026R Vegetable | LC033R Vegetable |
|----------------------|------------------|------------------|------------------|------------------|------------------|
| LES | 9.8mm | 14.5mm | | | |
| Typical | 34.6V | | | | |
| | 12.5W | 15.6W | 18.7W | 24.9W | 31.1W |
| | 360mA | 450mA | 540mA | 720mA | 900mA |
| Max. | 34.5W | 43.1W | 51.8W | 69.0W | 86.2W |
| | 920mA | 1150mA | 1380mA | 1840mA | 2300mA |
| Size | 13.5mm x 13.5mm | 19mm x 19mm | | | |

Specifications

| Product | Color Rank | Part Number | T _j = 85°C | | I _f (mA) V _f (V) |
|---|---------------|-------------------|----------------------------|----------------------------------|---|
| | | | Luminous Flux Typ. (lm) | Luminous Efficacy Typ. (lm/W) | |
|  LC013R Meat | MacAdam 2step | SPHWHHDND2VYZTSD2 | 914 | 73 | 360mA 34.6V |
|  LC016R Meat | MacAdam 2step | SPHWHHDNE2VYZTSD2 | 1188 | 76 | 450mA 34.6V |
|  LC019R Meat | MacAdam 2step | SPHWHHDNF2VYZTSD2 | 1412 | 76 | 540mA 34.6V |
|  LC026R Meat | MacAdam 2step | SPHWHHDNG2VYZTSD2 | 1845 | 74 | 720mA 34.6V |
|  LC033R Meat | MacAdam 2step | SPHWHHDNH2VYZTSD2 | 2284 | 73 | 900mA 34.6V |

Specifications

| Product | Color Rank | Part Number | T _j = 85°C | | I _f (mA) V _f (V) |
|--|---------------|-------------------|----------------------------|----------------------------------|---|
| | | | Luminous Flux Typ. (lm) | Luminous Efficacy Typ. (lm/W) | |
|  LC013R Vegetable | MacAdam 2step | SPHWHHDND2VYZRSD2 | 1188 | 95 | 360mA 34.6V |
|  LC016R Vegetable | MacAdam 2step | SPHWHHDNE2VYZRSD2 | 1544 | 99 | 450mA 34.6V |
|  LC019R Vegetable | MacAdam 2step | SPHWHHDNF2VYZRSD2 | 1835 | 98 | 540mA 34.6V |
|  LC026R Vegetable | MacAdam 2step | SPHWHHDNG2VYZRSD2 | 2399 | 96 | 720mA 34.6V |
|  LC033R Vegetable | MacAdam 2step | SPHWHHDNH2VYZRSD2 | 2969 | 95 | 900mA 34.6V |



T-Series

Perfect Ambience Created by Light

Tunable lighting enriches your life more than ever through superb optimizations

T-series with White Color Tunability

Provides a wide CCT tunable range

High Color Quality

Excellent color mixing with optimized chip arrangements

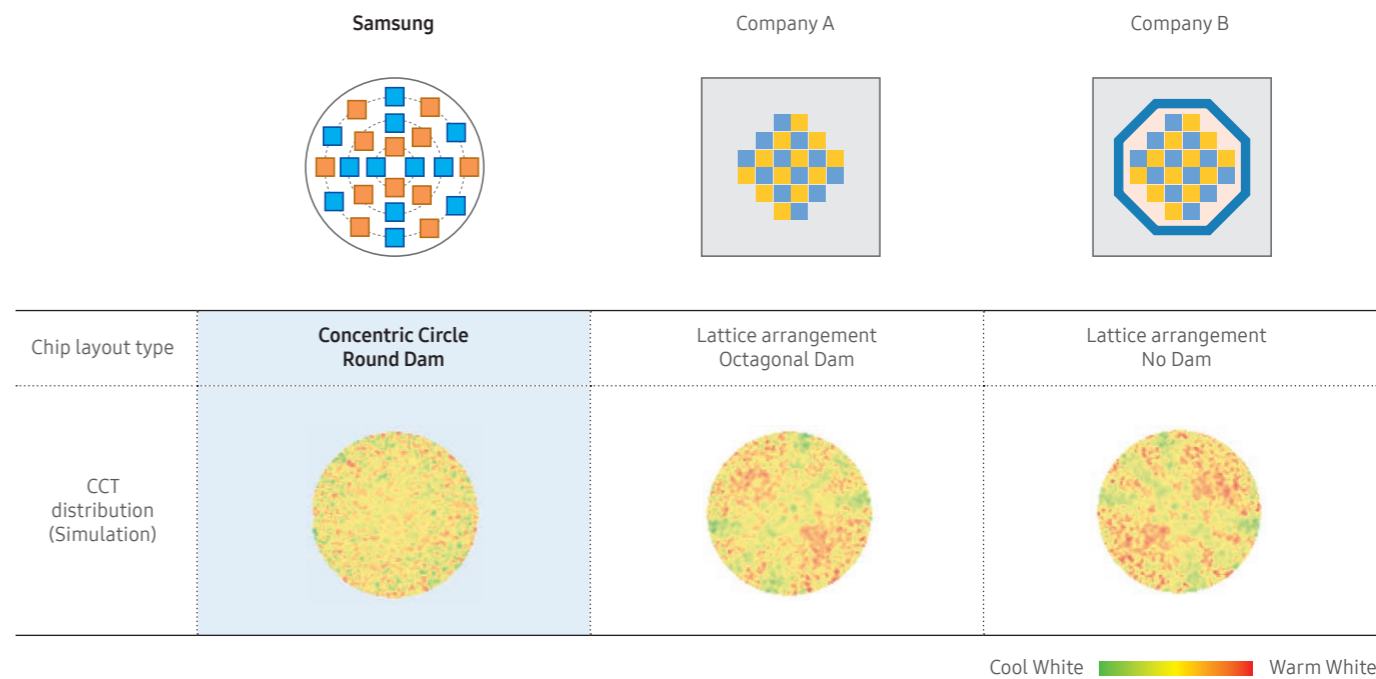

Wide Range of Color Temperature

From 2700K thru 6500K white color tunable

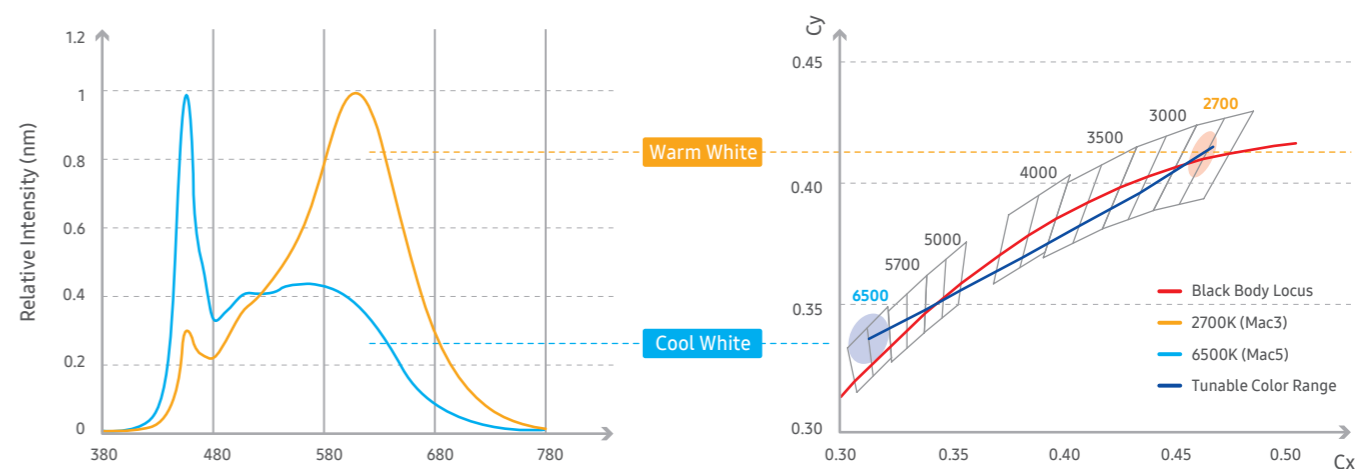

T-series



| T _j =85°C | LC010T | LC020T | LC035T |
|----------------------|-------------|--------|-------------|
| LES | 9.8mm | 13mm | 22mm |
| Typical | 9.8W | 19.6W | 34.3W |
| | 280mA | 560mA | 980mA |
| Max. | 15W | 30W | 45W |
| | 400mA | 800mA | 1250mA |
| Size | 19mm x 19mm | | 28mm x 28mm |

Product Details

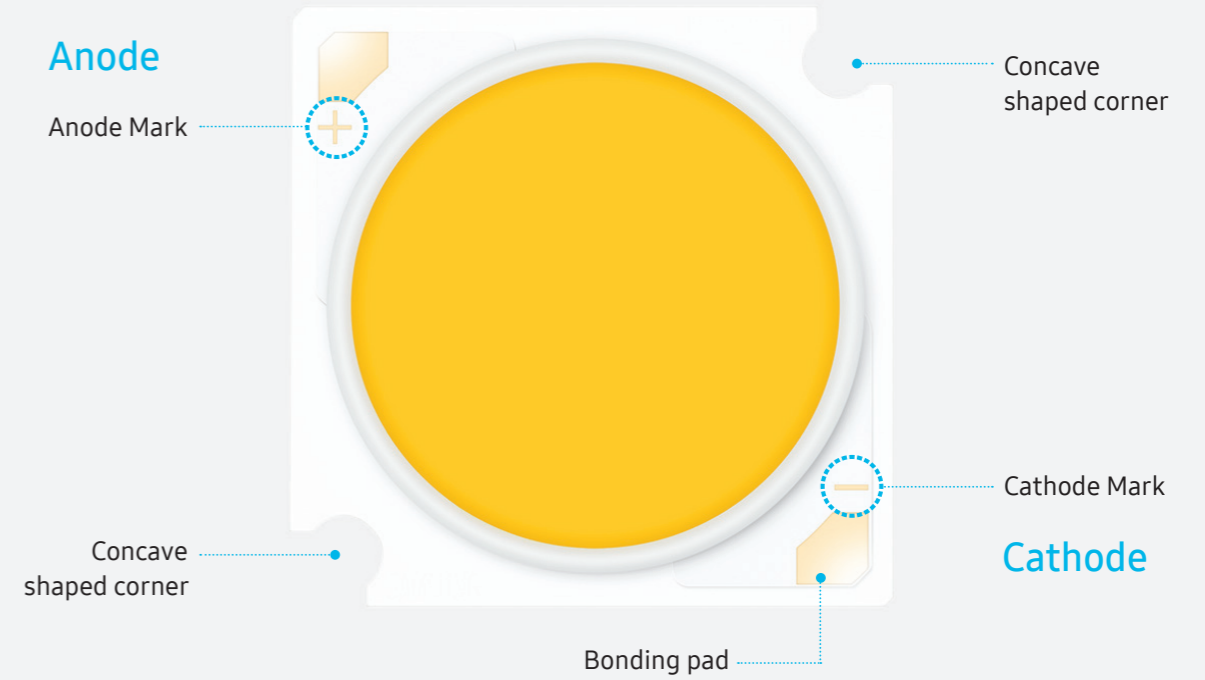

Specifications

| Product | CRI | CCT (K) | Color Rank | Part Number | T _j = 85°C | | I _F (mA) V _F (V) |
|---|-----|---------|---------------|-------------------|-------------------------|-------------------------------|---|
| | | | | | Luminous Flux Typ. (lm) | Luminous Efficacy Typ. (lm/W) | |
|  LC010T | 80+ | 2700 | MacAdam 3step | SPHWAHDNC25YZWPT1 | 1011 | 103 | 280mA 35V |
| | | 6500 | MacAdam 5step | | 1313 | 134 | |
|  LC020T | 80+ | 2700 | MacAdam 3step | SPHWAHDNF25YZWPT1 | 2022 | 103 | 560mA 35V |
| | | 6500 | MacAdam 5step | | 2626 | 134 | |
|  LC035T | 80+ | 2700 | MacAdam 3step | SPHWAHDNH25YZWPT1 | 3698 | 108 | 980mA 35V |
| | | 6500 | MacAdam 5step | | 4802 | 140 | |

Product Dimensions

D-series

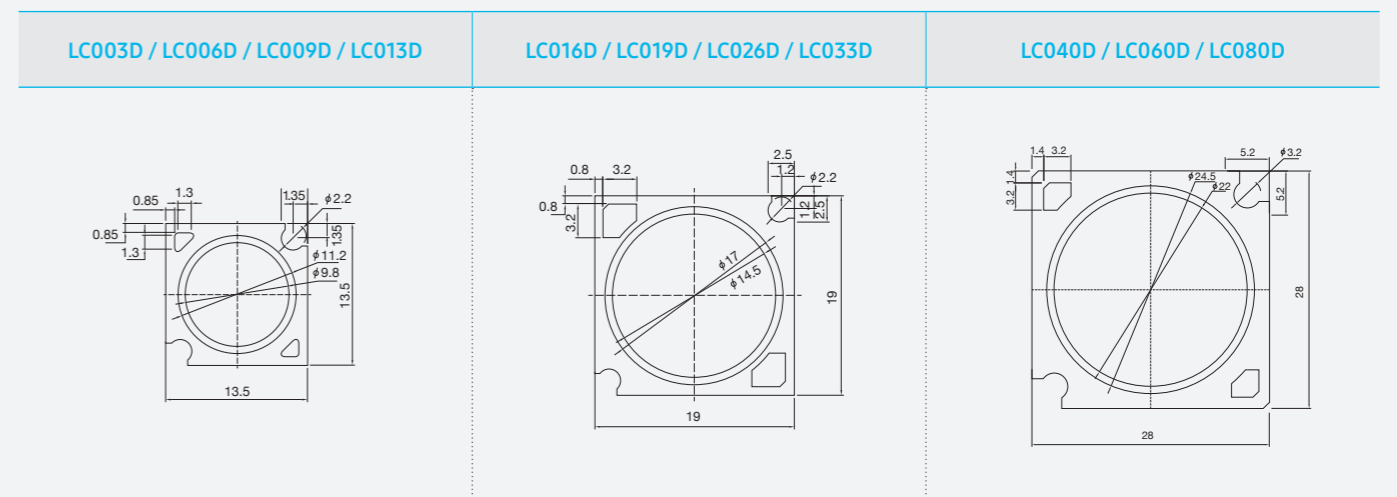

Product Dimensions

C-series

| LC010C Gen 2 | LC020C Gen 2 | LC030C Gen 2 / LC040C Gen 2 |
|--------------|--------------|-----------------------------|
| | | |

R-series

| LC003R / LC006R / LC009R / LC013R | LC016R / LC019R / LC026R / LC033R | LC040R / LC060R / LC080R |
|-----------------------------------|-----------------------------------|--------------------------|
| | | |

T-series

| LC010T | LC020T | LC035T |
|--------|--------|--------|
| | | |



One Stop Solution

Samsung maintains a close partnership with major component makers across the industry with expertise in power, optic, holder and thermal management technology. This wide network enables the "One Stop Solution" for our customers, realizing superior compatibility and convenient set-ups.



Looking for pricing, stock, or lifecycle information?

Click below to explore more details on WIN SOURCE:

-  [View SPHWHAHNDNL251ZT3Q6 on WIN SOURCE](#)
-  [Samsung Information](#)

Optimize Your Supply Chain with WIN SOURCE Solutions

-  Global Sourcing Solution
-  Obsolete Management
-  Cost Control Management
-  Shortage Management
-  Alternative Solution
-  Excess Inventory Management