

0.5 AND 4.0 AMP ISODRIVERS (2.5 AND 5 kV_{RMS})

Features

- Two completely isolated drivers in one package
 - Up to 5 kV_{RMS} input-to-output isolation
 - Up to 1500 V_{DC} peak driver-to-driver differential voltage
- HS/LS and dual driver versions
- Up to 8 MHz switching frequency
- 0.5 A peak output (Si8230/1/2/7)
- 4.0 A peak output (Si8233/4/5/6/8)
- High electromagnetic immunity
- 60 ns propagation delay (max)
- Independent HS and LS inputs or PWM input versions
- Transient immunity >45 kV/μs
- Overlap protection and programmable dead time
- AEC-Q100 qualification
- Wide operating range
 - -40 to +125 °C
- RoHS-compliant packages
 - SOIC-16 wide body
 - SOIC-16 narrow body
 - LGA-14

Applications

- Power delivery systems
- Motor control systems
- Isolated dc-dc power supplies
- Lighting control systems
- Plasma displays
- Solar and industrial inverters

Safety Approval

- UL 1577 recognized
 - Up to 5000 V_{rms} for 1 minute
- CSA component notice 5A approval
 - IEC 60950-1, 61010-1, 60601-1 (reinforced insulation)
- VDE certification conformity
 - IEC 60747-5-5 (VDE 0884 Part 5)
 - EN 60950-1 (reinforced insulation)
- CQC certification approval
 - GB4943.1

Description

The Si823x isolated driver family combines two independent, isolated drivers into a single package. The Si8230/1/3/4 are high-side/low-side drivers, and the Si8232/5/6/7/8 are dual drivers. Versions with peak output currents of 0.5 A (Si8230/1/2/7) and 4.0 A (Si8233/4/5/6/8) are available. All drivers operate with a maximum supply voltage of 24 V.

The Si823x drivers utilize Silicon Labs' proprietary silicon isolation technology, which provides up to 5 kV_{RMS} withstand voltage per UL1577 and fast 60 ns propagation times. Driver outputs can be grounded to the same or separate grounds or connected to a positive or negative voltage. The TTL level compatible inputs with >400 mV hysteresis are available in individual control input (Si8230/2/3/5/6/7/8) or PWM input (Si8231/4) configurations. High integration, low propagation delay, small installed size, flexibility, and cost-effectiveness make the Si823x family ideal for a wide range of isolated MOSFET/IGBT gate drive applications.



TABLE OF CONTENTS

| <u>Section</u> | <u>Page</u> |
|---|--------------------|
| 1. Top-Level Block Diagrams | 4 |
| 2. Electrical Specifications | 6 |
| 2.1. Test Circuits | 9 |
| 3. Functional Description | 16 |
| 3.1. Typical Operating Characteristics (0.5 Amp) | 17 |
| 3.2. Typical Operating Characteristics (4.0 Amp) | 19 |
| 3.3. Family Overview and Logic Operation During Startup | 21 |
| 3.4. Power Supply Connections | 23 |
| 3.5. Power Dissipation Considerations | 23 |
| 3.6. Layout Considerations | 26 |
| 3.7. Undervoltage Lockout Operation | 26 |
| 3.8. Programmable Dead Time and Overlap Protection | 28 |
| 4. Applications | 30 |
| 4.1. High-Side/Low-Side Driver | 30 |
| 4.2. Dual Driver | 31 |
| 4.3. Dual Driver with Thermally Enhanced Package (Si8236) | 31 |
| 5. Pin Descriptions | 32 |
| 6. Ordering Guide | 39 |
| 7. Package Outline: 16-Pin Wide Body SOIC | 43 |
| 8. Land Pattern: 16-Pin Wide Body SOIC | 45 |
| 9. Package Outline: 16-Pin Narrow Body SOIC | 46 |
| 10. Land Pattern: 16-Pin Narrow Body SOIC | 47 |
| 11. Package Outline: 14 LD LGA (5 x 5 mm) | 48 |
| 12. Land Pattern: 14 LD LGA | 49 |
| 13. Package Outline: 14 LD LGA with Thermal Pad (5 x 5 mm) | 50 |
| 14. Land Pattern: 14 LD LGA with Thermal Pad | 51 |
| 15. Top Markings | 52 |
| 15.1. Si823x Top Marking (16-Pin Wide Body SOIC) | 52 |
| 15.2. Top Marking Explanation (16-Pin Wide Body SOIC) | 52 |
| 15.3. Si823x Top Marking (16-Pin Narrow Body SOIC) | 53 |
| 15.4. Top Marking Explanation (16-Pin Narrow Body SOIC) | 53 |
| 15.5. Si823x Top Marking (14 LD LGA) | 54 |
| 15.6. Top Marking Explanation (14 LD LGA) | 54 |
| Document Change List | 55 |
| Contact Information | 56 |

1. Top-Level Block Diagrams



Figure 1. Si8230/3 Two-Input High-Side/Low-Side Isolated Drivers



Figure 2. Si8231/4 Single-Input High-Side/Low-Side Isolated Drivers



Figure 3. Si8232/5/6/7/8 Dual Isolated Drivers

2. Electrical Specifications

Table 1. Electrical Characteristics¹

2.7 V < VDDI < 5.5 V, VDDA = VDDB = 12 V or 15 V. TA = -40 to +125 °C. Typical specs at 25 °C

| Parameter | Symbol | Test Condition | Min | Typ | Max | Unit |
|--|-----------------------|---|---------------------------|--------|------------|-------|
| DC Specifications | | | | | | |
| Input-side Power Supply Voltage | VDDI | Si8230/1/2/3/4/5/6 Si8237/8 | 4.5 2.7 | — — | 5.5 5.5 | V |
| Driver Supply Voltage | VDDA, VDDB | Voltage between VDDA and GNDA, and VDDB and GNDB (See “6. Ordering Guide”) | 6.5 | — | 24 | V |
| Input Supply Quiescent Current | IDDI(Q) | Si8230/2/3/5/6/7/8 | — | 2 | 3 | mA |
| | | Si8231/4 | — | 3.5 | 5 | mA |
| Output Supply Quiescent Current | IDDA(Q), IDDB(Q) | Current per channel | — | — | 3.0 | mA |
| Input Supply Active Current | IDDI | Input freq = 500 kHz, no load | — | 3.5 | — | mA |
| Output Supply Active Current | IDDA IDDB | Current per channel with Input freq = 500 kHz, no load | — | 6 | — | mA |
| Input Pin Leakage Current | IVIA, IVIB, IPWM | | -10 | — | +10 | µA dc |
| Input Pin Leakage Current | IDISABLE | | -10 | — | +10 | µA dc |
| Logic High Input Threshold | VIH | | 2.0 | — | — | V |
| Logic Low Input Threshold | VIL | | — | — | 0.8 | V |
| Input Hysteresis | VI _{HYST} | Si8230/1/2/3/4/5/6/7/8 | 400 | 450 | — | mV |
| Logic High Output Voltage | VOAH, VOBH | IOA, IOB = -1 mA | (VDDA /VDDB) — 0.04 | — | — | V |
| Logic Low Output Voltage | VOAL, VOBL | IOA, IOB = 1 mA | — | — | 0.04 | V |
| Output Short-Circuit Pulsed Sink Current | IOA(SCL), IOB(SCL) | Si8230/1/2/7, Figure 4 | — | 0.5 | — | A |
| | | Si8233/4/5/6/8, Figure 4 | — | 4.0 | — | A |
| Output Short-Circuit Pulsed Source Current | IOA(SCH), IOB(SCH) | Si8230/1/2/7, Figure 5 | — | 0.25 | — | A |
| | | Si8233/4/5/6/8, Figure 5 | — | 2.0 | — | A |
| Output Sink Resistance | R _{ON(SINK)} | Si8230/1/2/7 | — | 5.0 | — | Ω |
| | | Si8233/4/5/6/8 | — | 1.0 | — | Ω |
| Notes: | | | | | | |
| 1. VDDA = VDDB = 12 V for 5, 8, and 10 V UVLO devices; VDDA = VDDB = 15 V for 12.5 V UVLO devices. | | | | | | |
| 2. TDD is the minimum overlap time without triggering overlap protection (Si8230/1/3/4 only). | | | | | | |
| 3. The largest RDT resistor that can be used is 220 kΩ. | | | | | | |

Table 1. Electrical Characteristics¹ (Continued)

2.7 V < VDDI < 5.5 V, VDDA = VDDDB = 12 V or 15 V. TA = -40 to +125 °C. Typical specs at 25 °C

| Parameter | Symbol | Test Condition | Min | Typ | Max | Unit |
|------------------------------------|---|--------------------------------------|------|------|------|------|
| Output Source Resistance | R _{ON(SOURCE)} | Si8230/1/2/7 | — | 15 | — | Ω |
| | | Si8233/4/5/6/8 | — | 2.7 | — | Ω |
| VDDI Undervoltage Threshold | VDDI _{UV+} | VDDI rising (Si8230/1/2/3/4/5/6) | 3.60 | 4.0 | 4.45 | V |
| VDDI Undervoltage Threshold | VDDI _{UV-} | VDDI falling (Si8230/1/2/3/4/5/6) | 3.30 | 3.70 | 4.15 | V |
| VDDI Lockout Hysteresis | VDDI _{HYS} | (Si8230/1/2/3/4/5/6) | — | 250 | — | mV |
| VDDI Undervoltage Threshold | VDDI _{UV+} | VDDI rising (Si8237/8) | 2.15 | 2.3 | 2.5 | V |
| VDDI Undervoltage Threshold | VDDI _{UV-} | VDDI falling (Si8237/8) | 2.10 | 2.22 | 2.40 | V |
| VDDI Lockout Hysteresis | VDDI _{HYS} | (Si8237/8) | — | 75 | — | mV |
| VDDA, VDDDB Undervoltage Threshold | VDDA _{UV+} , VDDDB _{UV+} | VDDA, VDDDB rising | | | | |
| 5 V Threshold | | See Figure 37 on page 27. | 5.20 | 5.80 | 6.30 | V |
| 8 V Threshold | | See Figure 38 on page 27. | 7.50 | 8.60 | 9.40 | V |
| 10 V Threshold | | See Figure 39 on page 27. | 9.60 | 11.1 | 12.2 | V |
| 12.5 V Threshold | | See Figure 40 on page 27. | 12.4 | 13.8 | 14.8 | V |
| VDDA, VDDDB Undervoltage Threshold | VDDA _{UV-} , VDDDB _{UV-} | VDDA, VDDDB falling | | | | |
| 5 V Threshold | | See Figure 37 on page 27. | 4.90 | 5.52 | 6.0 | V |
| 8 V Threshold | | See Figure 38 on page 27. | 7.20 | 8.10 | 8.70 | V |
| 10 V Threshold | | See Figure 39 on page 27. | 9.40 | 10.1 | 10.9 | V |
| 12.5 V Threshold | | See Figure 40 on page 27. | 11.6 | 12.8 | 13.8 | V |
| VDDA, VDDDB Lockout Hysteresis | VDDA _{HYS} , VDDDB _{HYS} | UVLO voltage = 5 V | — | 280 | — | mV |
| VDDA, VDDDB Lockout Hysteresis | VDDA _{HYS} , VDDDB _{HYS} | UVLO voltage = 8 V | — | 600 | — | mV |
| VDDA, VDDDB Lockout Hysteresis | VDDA _{HYS} , VDDDB _{HYS} | UVLO voltage = 10 V or 12.5 V | — | 1000 | — | mV |

Notes:

1. VDDA = VDDDB = 12 V for 5, 8, and 10 V UVLO devices; VDDA = VDDDB = 15 V for 12.5 V UVLO devices.
2. TDD is the minimum overlap time without triggering overlap protection (Si8230/1/3/4 only).
3. The largest RDT resistor that can be used is 220 kΩ.

Si823x

Table 1. Electrical Characteristics¹ (Continued)

2.7 V < VDDI < 5.5 V, VDDA = VDDDB = 12 V or 15 V. TA = -40 to +125 °C. Typical specs at 25 °C

| Parameter | Symbol | Test Condition | Min | Typ | Max | Unit |
|--|--------------------|---|-----|-----|------|-------|
| AC Specifications | | | | | | |
| Minimum Pulse Width | | | — | 10 | — | ns |
| Propagation Delay | t_{PHL}, t_{PLH} | CL = 200 pF | — | 30 | 60 | ns |
| Pulse Width Distortion $ t_{PLH} - t_{PHL} $ | PWD | | — | — | 5.60 | ns |
| Minimum Overlap Time ² | TDD | DT = VDDI, No-Connect | — | 0.4 | — | ns |
| Programmed Dead Time ³ | DT | Figure 42, RDT = 100 k | — | 900 | — | ns |
| | | Figure 42, RDT = 6 k | — | 70 | — | ns |
| Output Rise and Fall Time | t_R, t_F | C _L = 200 pF (Si8230/1/2/7) | — | — | 20 | ns |
| | | C _L = 200 pF (Si8233/4/5/6/8) | — | — | 12 | ns |
| Shutdown Time from Disable True | t_{SD} | | — | — | 60 | ns |
| Restart Time from Disable False | $t_{RESTART}$ | | — | — | 60 | ns |
| Device Start-up Time | t_{START} | Time from VDD ₋ = VDD _{-UV+} to VOA, VOB = VIA, VIB | — | — | 40 | μs |
| Common Mode Transient Immunity | CMTI | VIA, VIB, PWM = VDDI or 0 V V _{CM} = 1500 V (see Figure 6) | 20 | 45 | — | kV/μs |
| Notes: | | | | | | |
| 1. VDDA = VDDDB = 12 V for 5, 8, and 10 V UVLO devices; VDDA = VDDDB = 15 V for 12.5 V UVLO devices. | | | | | | |
| 2. TDD is the minimum overlap time without triggering overlap protection (Si8230/1/3/4 only). | | | | | | |
| 3. The largest RDT resistor that can be used is 220 kΩ. | | | | | | |

2.1. Test Circuits

Figures 4, 5, and 6 depict sink current, source current, and common-mode transient immunity test circuits, respectively.



Figure 4. IOL Sink Current Test Circuit

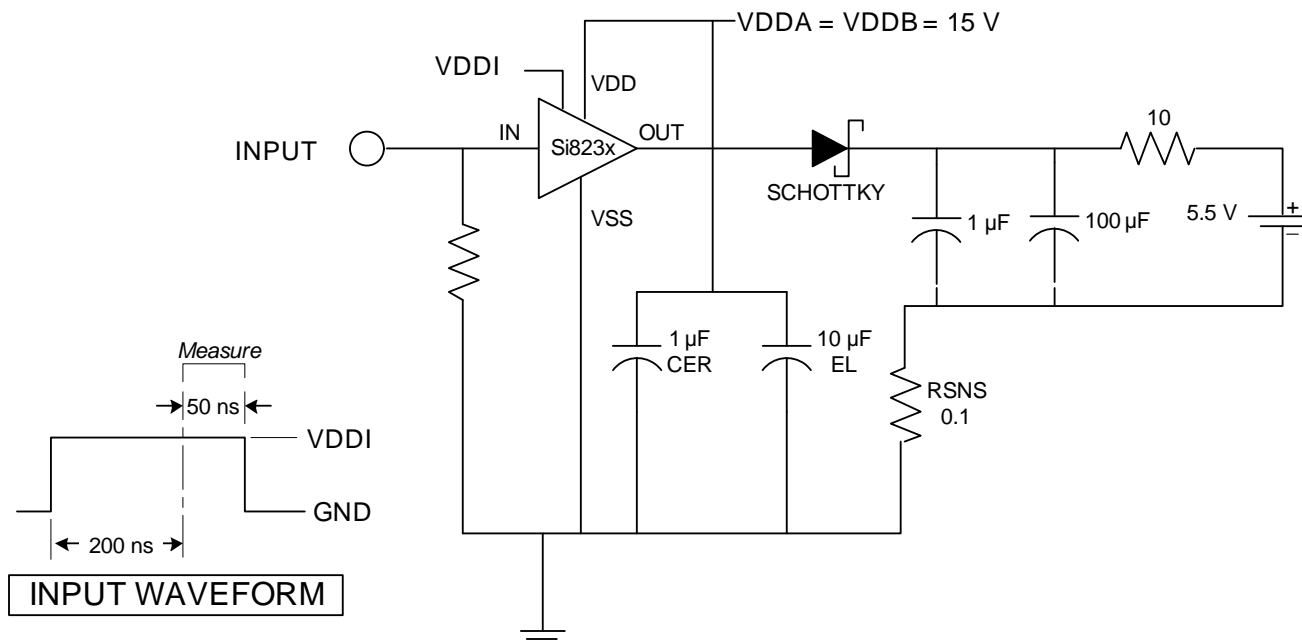

Figure 5. IOH Source Current Test Circuit



Figure 6. Common Mode Transient Immunity Test Circuit

Table 2. Regulatory Information^{1,2,3,4}

| |
|--|
| CSA |
| The Si823x is certified under CSA Component Acceptance Notice 5A. For more details, see File 232873. |
| 61010-1: Up to 600 V _{RMS} reinforced insulation working voltage; up to 600 V _{RMS} basic insulation working voltage. |
| 60950-1: Up to 600 V _{RMS} reinforced insulation working voltage; up to 1000 V _{RMS} basic insulation working voltage. |
| 60601-1: Up to 125 V _{RMS} reinforced insulation working voltage; up to 380 V _{RMS} basic insulation working voltage. |
| VDE |
| The Si823x is certified according to IEC 60747-5-5. For more details, see File 5006301-4880-0001. |
| 60747-5-5: Up to 891 V _{peak} for basic insulation working voltage. |
| 60950-1: Up to 600 V _{RMS} reinforced insulation working voltage; up to 1000 V _{RMS} basic insulation working voltage. |
| UL |
| The Si823x is certified under UL1577 component recognition program. For more details, see File E257455. |
| Rated up to 5000 V _{RMS} isolation voltage for basic protection. |
| CQC |
| The Si823x is certified under GB4943.1-2011. For more details, see File V2012CQC001041. |
| Rated up to 600 V _{RMS} reinforced insulation working voltage; up to 1000 V _{RMS} basic insulation working voltage. |
| Notes: |
| <ol style="list-style-type: none"> 1. Regulatory Certifications apply to 2.5 kV_{RMS} rated devices which are production tested to 3.0 kV_{RMS} for 1 sec. 2. Regulatory Certifications apply to 3.75 kV_{RMS} rated devices which are production tested to 4.5 kV_{RMS} for 1 sec. 3. Regulatory Certifications apply to 5.0 kV_{RMS} rated devices which are production tested to 6.0 kV_{RMS} for 1 sec. 4. For more information, see "6. Ordering Guide" on page 39. |

Table 3. Insulation and Safety-Related Specifications

| Parameter | Symbol | Test Condition | Value | | | | Unit |
|--|-----------------|----------------|----------------------------------|---|---------------------------------------|---|------|
| | | | WBSOIC-16 5 kV _{RMS} | WBSOIC-16 NBSOIC-16 2.5 kV _{RMS} | 14 LD LGA 2.5 kV _{RMS} | 14 LD LGA with Pad 1.0 kV _{RMS} | |
| Nominal Air Gap (Clearance) ¹ | L(101) | | 8.0 | 8.0/4.01 | 3.5 | 1.75 | mm |
| Nominal External Tracking (Creepage) ¹ | L(102) | | 8.0 | 8.0/4.01 | 3.5 | 1.75 | mm |
| Minimum Internal Gap (Internal Clearance) | | | 0.014 | 0.014 | 0.014 | 0.014 | mm |
| Tracking Resistance (Proof Tracking Index) | PTI | IEC60112 | 600 | 600 | 600 | 600 | V |
| Erosion Depth | ED | | 0.040 | 0.019 | 0.021 | 0.021 | mm |
| Resistance (Input-Output) ² | R _{IO} | | 10 ¹² | 10 ¹² | 10 ¹² | 10 ¹² | Ω |
| Capacitance (Input-Output) ² | C _{IO} | f = 1 MHz | 1.4 | 1.4 | 1.4 | 1.4 | pF |
| Input Capacitance ³ | C _I | | 4.0 | 4.0 | 4.0 | 4.0 | pF |

Notes:

- The values in this table correspond to the nominal creepage and clearance values as detailed in “7. Package Outline: 16-Pin Wide Body SOIC” , “9. Package Outline: 16-Pin Narrow Body SOIC” , “11. Package Outline: 14 LD LGA (5 x 5 mm)” , and “13. Package Outline: 14 LD LGA with Thermal Pad (5 x 5 mm)” . VDE certifies the clearance and creepage limits as 4.7 mm minimum for the NB SOIC-16 and 8.5 mm minimum for the WB SOIC-16 package. UL does not impose a clearance and creepage minimum for component level certifications. CSA certifies the clearance and creepage limits as 3.9 mm minimum for the NB SOIC 16 and 7.6 mm minimum for the WB SOIC-16 package.
- To determine resistance and capacitance, the Si823x is converted into a 2-terminal device. Pins 1–8 (1-7, 14 LD LGA) are shorted together to form the first terminal and pins 9–16 (8-14, 14 LD LGA) are shorted together to form the second terminal. The parameters are then measured between these two terminals.
- Measured from input pin to ground.

Table 4. IEC 60664-1 (VDE 0884 Part 5) Ratings

| Parameter | Test Condition | Specification | | | |
|-----------------------------|---|---------------|---------------|--------------|--------------------------|
| | | WB SOIC-16 | NB SOIC-16 | 14 LD LGA | 14 LD LGA with Pad |
| Basic Isolation Group | Material Group | I | I | I | I |
| Installation Classification | Rated Mains Voltages ≤ 150 V _{RMS} | I-IV | I-IV | I-IV | I-IV |
| | Rated Mains Voltages ≤ 300 V _{RMS} | I-IV | I-III | I-III | I-III |
| | Rated Mains Voltages ≤ 400 V _{RMS} | I-III | I-II | I-II | I-II |
| | Rated Mains Voltages ≤ 600 V _{RMS} | I-III | I-II | I-II | I-I |

Table 5. IEC 60747-5-5 Insulation Characteristics*

| Parameter | Symbol | Test Condition | Characteristic | | | Unit |
|--|------------|---|----------------|----------------------|--------------------|----------|
| | | | WB SOIC-16 | NB SOIC-16 14 LD LGA | 14 LD LGA with Pad | |
| Maximum Working Insulation Voltage | V_{IORM} | | 891 | 560 | 373 | V peak |
| Input to Output Test Voltage | V_{PR} | Method b1 ($V_{IORM} \times 1.875 = V_{PR}$, 100% Production Test, $t_m = 1$ sec, Partial Discharge < 5 pC) | 1375 | 1050 | 700 | V peak |
| Transient Overvoltage | V_{IOTM} | $t = 60$ sec | 6000 | 4000 | 2650 | V peak |
| Pollution Degree (DIN VDE 0110, Table 1) | | | 2 | 2 | 2 | |
| Insulation Resistance at T_S , $V_{IO} = 500$ V | R_S | | $>10^9$ | $>10^9$ | $>10^9$ | Ω |

***Note:** Maintenance of the safety data is ensured by protective circuits. The Si823x provides a climate classification of 40/125/21.

Table 6. IEC Safety Limiting Values¹

| Parameter | Symbol | Test Condition | WB SOIC-16 | NB SOIC-16 | 14 LD LGA | 14 LD LGA with Pad | Unit |
|---------------------------------------|--------|---|------------|------------|-----------|--------------------|------|
| Case Temperature | T_S | | 150 | 150 | 150 | 150 | °C |
| Safety Input Current | I_S | $\theta_{JA} = 100$ °C/W (WB SOIC-16), 105 °C/W (NB SOIC-16, 14 LD LGA), 50 °C/W (14 LD LGA with Pad) $V_{DDI} = 5.5$ V, $V_{DDA} = V_{DDB} = 24$ V, $T_J = 150$ °C, $T_A = 25$ °C | 50 | 50 | 50 | 100 | mA |
| Device Power Dissipation ² | P_D | | 1.2 | 1.2 | 1.2 | 1.2 | W |

Notes:

- Maximum value allowed in the event of a failure. Refer to the thermal derating curve in Figures 7 and 8.
- The Si82xx is tested with $V_{DDI} = 5.5$ V, $V_{DDA} = V_{DDB} = 24$ V, $T_J = 150$ °C, $C_L = 100$ pF, input 2 MHz 50% duty cycle square wave.

Table 7. Thermal Characteristics

| Parameter | Symbol | WB SOIC-16 | NB SOIC-16 | 14 LD LGA | 14 LD LGA with Pad | Unit |
|---------------------------------------|---------------|------------|------------|-----------|--------------------|------|
| IC Junction-to-Air Thermal Resistance | θ_{JA} | 100 | 105 | 105 | 50 | °C/W |

Table 8. Absolute Maximum Ratings¹

| Parameter | Symbol | Min | Typ | Max | Unit |
|---|------------|------|-----|-----------|-----------|
| Storage Temperature ² | T_{STG} | -65 | — | +150 | °C |
| Ambient Temperature under Bias | T_A | -40 | — | +125 | °C |
| Junction Temperature | T_J | — | — | +150 | °C |
| Input-side Supply Voltage | VDDI | -0.6 | — | 6.0 | V |
| Driver-side Supply Voltage | VDDA, VDDB | -0.6 | — | 30 | V |
| Voltage on any Pin with respect to Ground | VIN | -0.5 | — | VDD + 0.5 | V |
| Output Drive Current per Channel | I_O | — | — | 10 | mA |
| Lead Solder Temperature (10 sec.) | | — | — | 260 | °C |
| Maximum Isolation (Input to Output) (1 sec) WB SOIC-16 | | — | — | 6500 | V_{RMS} |
| Maximum Isolation (Output to Output) (1 sec) WB SOIC-16 | | — | — | 2500 | V_{RMS} |
| Maximum Isolation (Input to Output) (1 sec) NB SOIC-16 | | — | — | 4250 | V_{RMS} |
| Maximum Isolation (Output to Output) (1 sec) NB SOIC-16 | | — | — | 2500 | V_{RMS} |
| Maximum Isolation (Input to Output) (1 sec) 14 LD LGA without Thermal Pad | | — | — | 3850 | V_{RMS} |
| Maximum Isolation (Output to Output) (1 sec) 14 LD LGA without Thermal Pad | | — | — | 650 | V_{RMS} |
| Maximum Isolation (Input to Output) (1 sec) 14 LD LGA with Thermal Pad | | — | — | 1850 | V_{RMS} |
| Maximum Isolation (Output to Output) (1 sec) 14 LD LGA with Thermal Pad | | — | — | 0 | V_{RMS} |

Notes:

1. Permanent device damage may occur if the absolute maximum ratings are exceeded. Functional operation should be restricted to the conditions as specified in the operational sections of this data sheet. Exposure to absolute maximum rating conditions for extended periods may affect device reliability.
2. VDE certifies storage temperature from -40 to 150 °C.



Figure 7. WB SOIC-16, NB SOIC-16, 14 LD LGA Thermal Derating Curve, Dependence of Safety Limiting Values with Case Temperature per DIN EN 60747-5-5



Figure 8. 14 LD LGA with Pad Thermal Derating Curve, Dependence of Safety Limiting Values with Case Temperature per DIN EN 60747-5-5

3. Functional Description

The operation of an Si823x channel is analogous to that of an optocoupler and gate driver, except an RF carrier is modulated instead of light. This simple architecture provides a robust isolated data path and requires no special considerations or initialization at start-up. A simplified block diagram for a single Si823x channel is shown in Figure 9.



Figure 9. Simplified Channel Diagram

A channel consists of an RF Transmitter and RF Receiver separated by a semiconductor-based isolation barrier. Referring to the Transmitter, input A modulates the carrier provided by an RF oscillator using on/off keying. The Receiver contains a demodulator that decodes the input state according to its RF energy content and applies the result to output B via the output driver. This RF on/off keying scheme is superior to pulse code schemes as it provides best-in-class noise immunity, low power consumption, and better immunity to magnetic fields. See Figure 10 for more details.



Figure 10. Modulation Scheme

3.1. Typical Operating Characteristics (0.5 Amp)

The typical performance characteristics depicted in Figures 11 through 22 are for information purposes only. Refer to Table 1 on page 6 for actual specification limits.



Figure 11. Rise/Fall Time vs. Supply Voltage

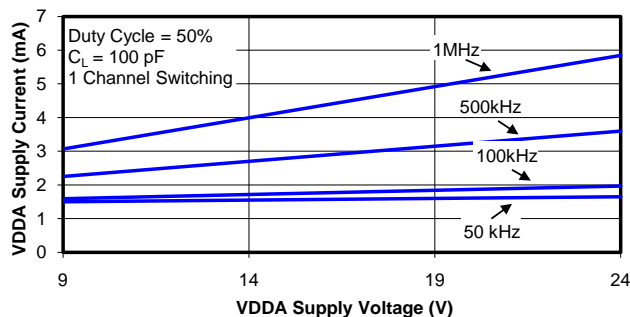

Figure 14. Supply Current vs. Supply Voltage



Figure 12. Propagation Delay vs. Supply Voltage



Figure 15. Supply Current vs. Temperature

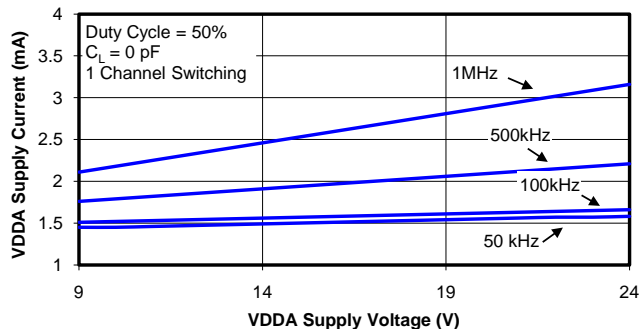

Figure 13. Supply Current vs. Supply Voltage



Figure 16. Rise/Fall Time vs. Load



Figure 17. Propagation Delay vs. Load

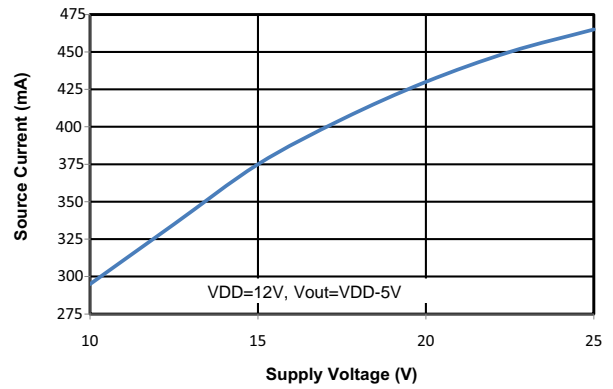

Figure 20. Output Source Current vs. Supply Voltage



Figure 18. Propagation Delay vs. Temperature

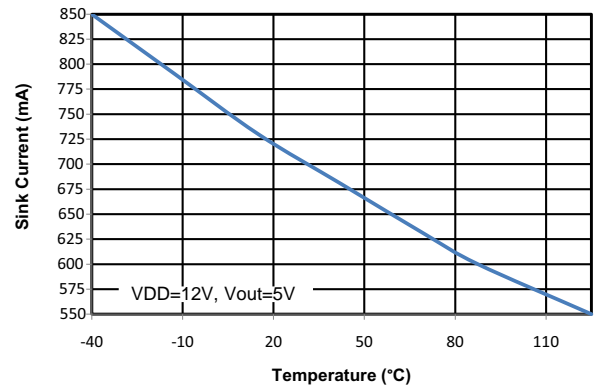

Figure 21. Output Sink Current vs. Temperature



Figure 19. Output Sink Current vs. Supply Voltage



Figure 22. Output Source Current vs. Temperature

3.2. Typical Operating Characteristics (4.0 Amp)

The typical performance characteristics depicted in Figures 23 through 34 are for information purposes only. Refer to Table 1 on page 6 for actual specification limits.

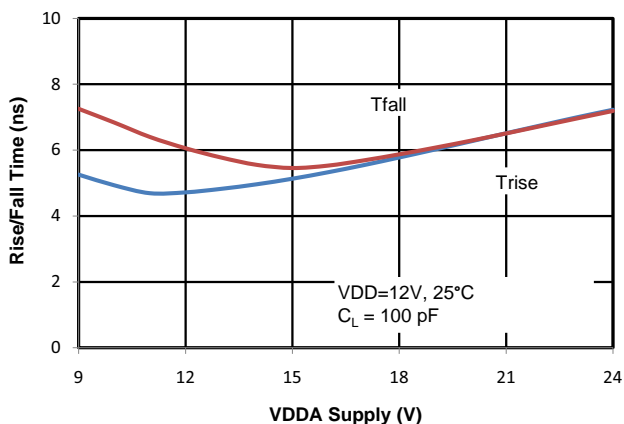

Figure 23. Rise/Fall Time vs. Supply Voltage

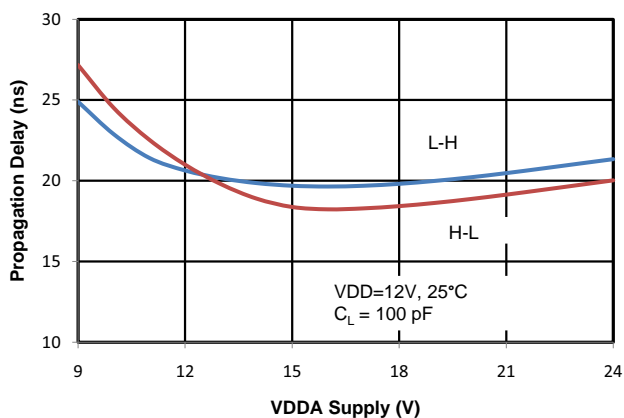

Figure 24. Propagation Delay vs. Supply Voltage

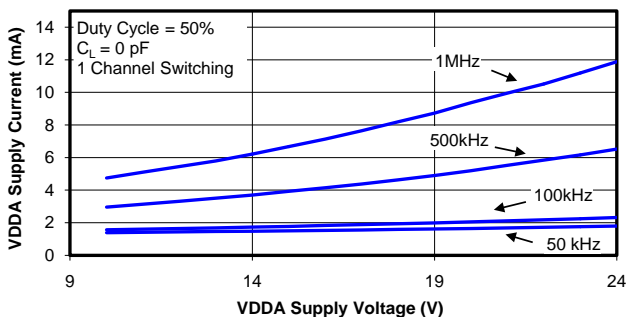

Figure 25. Supply Current vs. Supply Voltage

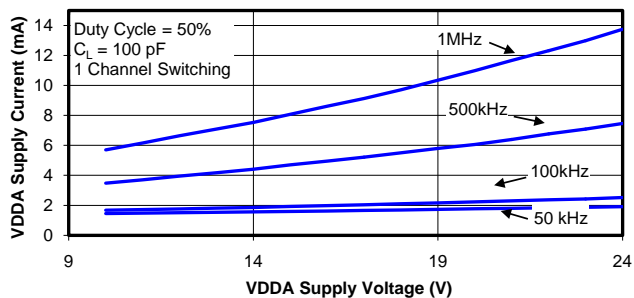

Figure 26. Supply Current vs. Supply Voltage

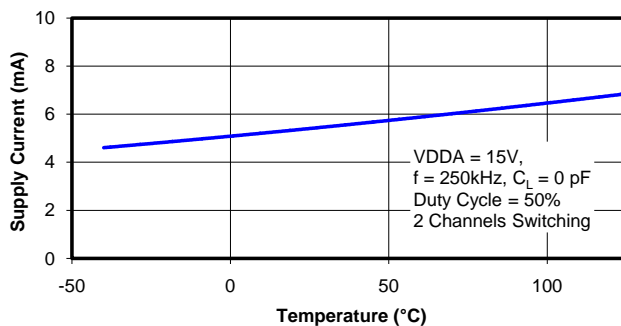

Figure 27. Supply Current vs. Temperature

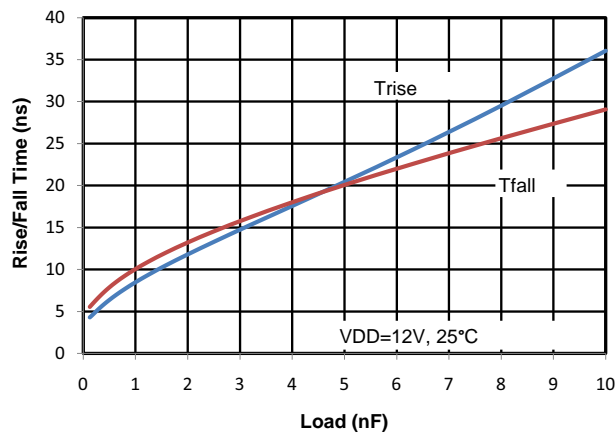

Figure 28. Rise/Fall Time vs. Load



Figure 29. Propagation Delay vs. Load



Figure 32. Output Source Current vs. Supply Voltage



Figure 30. Propagation Delay vs. Temperature



Figure 33. Output Sink Current vs. Temperature



Figure 31. Output Sink Current vs. Supply Voltage

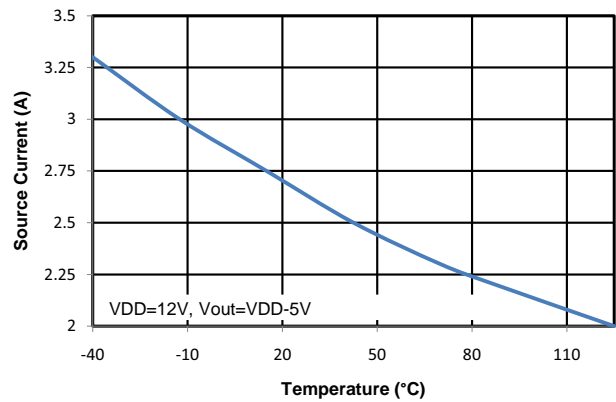

Figure 34. Output Source Current vs. Temperature

3.3. Family Overview and Logic Operation During Startup

The Si823x family of isolated drivers consists of high-side, low-side, and dual driver configurations.

3.3.1. Products

Table 9 shows the configuration and functional overview for each product in this family.

Table 9. Si823x Family Overview

| Part Number | Configuration | Overlap Protection | Programmable Dead Time | Inputs | Peak Output Current (A) |
|-------------|--------------------|--------------------|------------------------|----------|-------------------------|
| Si8230 | High-Side/Low-Side | ✓ | ✓ | VIA, VIB | 0.5 |
| Si8231 | High-Side/Low-Side | ✓ | ✓ | PWM | 0.5 |
| Si8232/7 | Dual Driver | — | — | VIA, VIB | 0.5 |
| Si8233 | High-Side/Low-Side | ✓ | ✓ | VIA, VIB | 4.0 |
| Si8234 | High-Side/Low-Side | ✓ | ✓ | PWM | 4.0 |
| Si8235/6/8 | Dual Driver | — | — | VIA, VIB | 4.0 |

3.3.2. Device Behavior

Table 10 consists of truth tables for the Si8230/3, Si8231/4, and Si8232/5/6 families.

Table 10. Si823x Family Truth Table¹

| Si8230/3 (High-Side/Low-Side) Truth Table | | | | | | |
|--|----------------|------------|---------|--------|--|---|
| Inputs | | VDDI State | Disable | Output | | Notes |
| VIA | VIB | | | VOA | VOB | |
| L | L | Powered | L | L | L | Output transition occurs after internal dead time expires. |
| L | H | Powered | L | L | H | Output transition occurs after internal dead time expires. |
| H | L | Powered | L | H | L | Output transition occurs after internal dead time expires. |
| H | H | Powered | L | L | L | Invalid state. Output transition occurs after internal dead time expires. |
| X ² | X ² | Unpowered | X | L | L | Output returns to input state within 7 μs of VDDI power restoration. |
| X | X | Powered | H | L | L | Device is disabled. |
| Si8231/4 (PWM Input High-Side/Low-Side) Truth Table | | | | | | |
| PWM Input | VDDI State | Disable | Output | | Notes | |
| | | | VOA | VOB | | |
| H | Powered | L | H | L | Output transition occurs after internal dead time expires. | |
| L | Powered | L | L | H | Output transition occurs after internal dead time expires. | |
| X ² | Unpowered | X | L | L | Output returns to input state within 7 μs of VDDI power restoration. | |
| X | Powered | H | L | L | Device is disabled. | |
| Notes: | | | | | | |
| 1. This truth table assumes VDDA and VDDB are powered. If VDDA and VDDB are below UVLO, see "3.7.2. Undervoltage Lockout" on page 26 for more information. | | | | | | |
| 2. Note that an input can power the input die through an internal diode if its source has adequate current. | | | | | | |

Table 10. Si823x Family Truth Table¹ (Continued)

| Si8232/5/6/7/8 (Dual Driver) Truth Table | | | | | | |
|--|----------------|------------|---------|--------|-----|--|
| Inputs | | VDDI State | Disable | Output | | Notes |
| VIA | VIB | | | VOA | VOB | |
| L | L | Powered | L | L | L | Output transition occurs immediately (no internal dead time). |
| L | H | Powered | L | L | H | Output transition occurs immediately (no internal dead time). |
| H | L | Powered | L | H | L | Output transition occurs immediately (no internal dead time). |
| H | H | Powered | L | H | H | Output transition occurs immediately (no internal dead time). |
| X ² | X ² | Unpowered | X | L | L | Output returns to input state within 7 μs of VDDI power restoration. |
| X | X | Powered | H | L | L | Device is disabled. |

Notes:

1. This truth table assumes VDDA and VDDB are powered. If VDDA and VDDB are below UVLO, see "3.7.2. Undervoltage Lockout" on page 26 for more information.
2. Note that an input can power the input die through an internal diode if its source has adequate current.

3.4. Power Supply Connections

Isolation requirements mandate individual supplies for VDDI, VDDA, and VDDB. The decoupling caps for these supplies must be placed as close to the VDD and GND pins of the Si823x as possible. The optimum values for these capacitors depend on load current and the distance between the chip and the regulator that powers it. Low effective series resistance (ESR) capacitors, such as Tantalum, are recommended.

3.5. Power Dissipation Considerations

Proper system design must assure that the Si823x operates within safe thermal limits across the entire load range. The Si823x total power dissipation is the sum of the power dissipated by bias supply current, internal parasitic switching losses, and power dissipated by the series gate resistor and load. Equation 1 shows total Si823x power dissipation.

$$P_D = (V_{DDI})(I_{DDI}) + 2(I_{DD2})(V_{DD2}) + (f)(Q_{TL})(V_{DD2})\left[\frac{R_p}{R_p + R_g}\right] + (f)(Q_{TL})(V_{DD2})\left[\frac{R_n}{R_n + R_g}\right] + 2fC_{int}V_{DD2}^2$$

where:

P_D is the total Si823x device power dissipation (W)

I_{DDI} is the input-side maximum bias current (3 mA)

I_{DD2} is the driver die maximum bias current (2.5 mA)

C_{int} is the internal parasitic capacitance (75 pF for the 0.5 A driver and 370 pF for the 4.0 A driver)

V_{DDI} is the input-side VDD supply voltage (2.7 to 5.5 V)

V_{DD2} is the driver-side supply voltage (10 to 24 V)

f is the switching frequency (Hz)

Q_{TL} is the total highside bootstrap charge (see Section 2.2 of AN486)

R_G is the external gate resistor

R_P is the $R_{DS(ON)}$ of the driver pull-up switch: ($R_p=15\Omega$ for the 0.5A driver; $R_p=2.7\Omega$ for the 4.0A driver)

R_n is the $R_{DS(ON)}$ of the driver pull-down switch: ($R_n=5\Omega$ for the 0.5A driver and 1Ω for the 4.0A driver)

Equation 1.

Power dissipation example for 0.5 A driver using Equation 1 with the following givens:

$$V_{DDI} = 5.0 \text{ V}$$

$$V_{DD2} = 12 \text{ V}$$

$$f = 350 \text{ kHz}$$

$$R_G = 22 \Omega$$

$$Q_G = 25 \text{ nC}$$

$$P_d = 0.015 + 0.060 + (350 \times 10^3)(25 \times 10^{-9})(12)\left[\frac{15}{15 + 22}\right] + (f)(Q_{TL})(V_{DD2})\left[\frac{5}{5 + 22}\right] + 2[(350 \times 10^3)(75 \times 10^{-12})(144)]$$

$$= 140 \text{ mW}$$

From which the driver junction temperature is calculated using Equation 2, where:

P_d is the total Si823x device power dissipation (W)

θ_{ja} is the thermal resistance from junction to air (105 °C/W in this example)

T_A is the ambient temperature

$$\begin{aligned}T_j &= P_d \times \theta_{ja} + T_A \\&= (0.145)(105) + 20 \\&= 35.2 \text{ }^\circ\text{C}\end{aligned}$$

The maximum power dissipation allowable for the Si823x is a function of the package thermal resistance, ambient temperature, and maximum allowable junction temperature, as shown in Equation 2:

$$P_{Dmax} \leq \frac{T_{jmax} - T_A}{\theta_{ja}}$$

where:

P_{Dmax} = Maximum Si823x power dissipation (W)

T_{jmax} = Si823x maximum junction temperature (150 °C)

T_A = Ambient temperature (°C)

θ_{ja} = Si823x junction-to-air thermal resistance (105 °C/W)

f = Si823x switching frequency (Hz)

Equation 2.

Substituting values for P_{Dmax} , T_{jmax} , T_A , and θ_{ja} into Equation 2 results in a maximum allowable total power dissipation of 1.19 W. Maximum allowable load is found by substituting this limit and the appropriate data sheet values from Table 1 on page 6 into Equation 1 and simplifying. The result is Equation 3 (0.5 A driver) and Equation 4 (4.0 A driver), both of which assume $VDDI = 5 \text{ V}$ and $VDDA = VDDB = 18 \text{ V}$.

$$C_{L(MAX)} = \frac{1.4 \times 10^{-3}}{f} - 7.5 \times 10^{-11}$$

Equation 3.

$$C_{L(MAX)} = \frac{1.4 \times 10^{-3}}{f} - 3.7 \times 10^{-10}$$

Equation 4.

Equation 1 and Equation 2 are graphed in Figure 35 where the points along the load line represent the package dissipation-limited value of CL for the corresponding switching frequency.



Figure 35. Max Load vs. Switching Frequency

3.6. Layout Considerations

It is most important to minimize ringing in the drive path and noise on the Si823x VDD lines. Care must be taken to minimize parasitic inductance in these paths by locating the Si823x as close to the device it is driving as possible. In addition, the VDD supply and ground trace paths must be kept short. For this reason, the use of power and ground planes is highly recommended. A split ground plane system having separate ground and VDD planes for power devices and small signal components provides the best overall noise performance.

3.7. Undervoltage Lockout Operation

Device behavior during start-up, normal operation and shutdown is shown in Figure 36, where UVLO+ and UVLO- are the positive-going and negative-going thresholds respectively. Note that outputs VOA and VOB default low when input side power supply (VDDI) is not present.

3.7.1. Device Startup

Outputs VOA and VOB are held low during power-up until VDD is above the UVLO threshold for time period tSTART. Following this, the outputs follow the states of inputs VIA and VIB.

3.7.2. Undervoltage Lockout

Undervoltage Lockout (UVLO) is provided to prevent erroneous operation during device startup and shutdown or when VDD is below its specified operating circuits range. The input (control) side, Driver A and Driver B, each have their own undervoltage lockout monitors.

The Si823x input side enters UVLO when $VDDI \leq VDDI_{UV-}$, and exits UVLO when $VDDI > VDDI_{UV+}$. The driver outputs, VOA and VOB, remain low when the input side of the Si823x is in UVLO and their respective VDD supply (VDDA, VDDDB) is within tolerance. Each driver output can enter or exit UVLO independently. For example, VOA unconditionally enters UVLO when VDDA falls below $VDDA_{UV-}$ and exits UVLO when VDDA rises above $VDDA_{UV+}$.

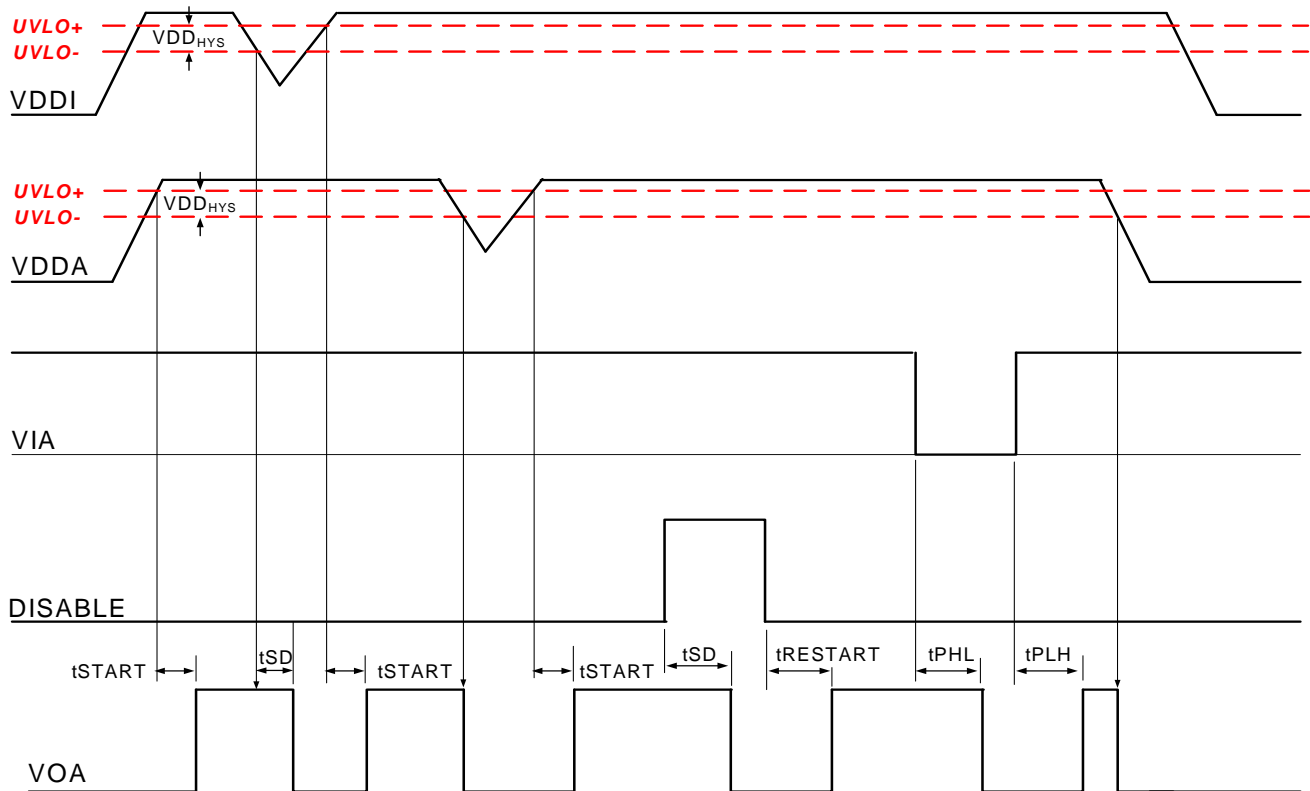

Figure 36. Device Behavior during Normal Operation and Shutdown

3.7.3. Undervoltage Lockout (UVLO)

The UVLO circuit unconditionally drives VO low when VDD is below the lockout threshold. Referring to Figures 37 through 40, upon power up, the Si823x is maintained in UVLO until VDD rises above V_{DDUV+} . During power down, the Si823x enters UVLO when VDD falls below the UVLO threshold plus hysteresis (i.e., $V_{DD} \leq V_{DDUV+} - V_{DDHYS}$).

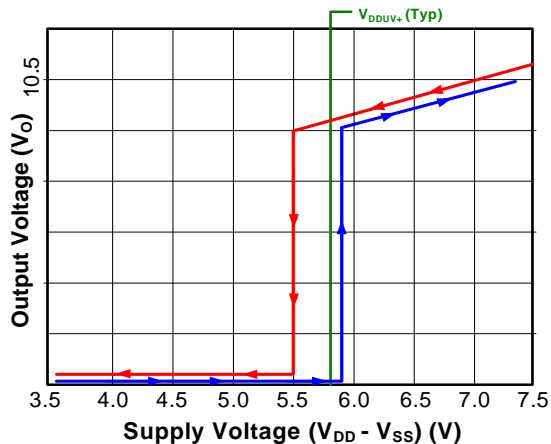

Figure 37. Si823x UVLO Response (5 V)

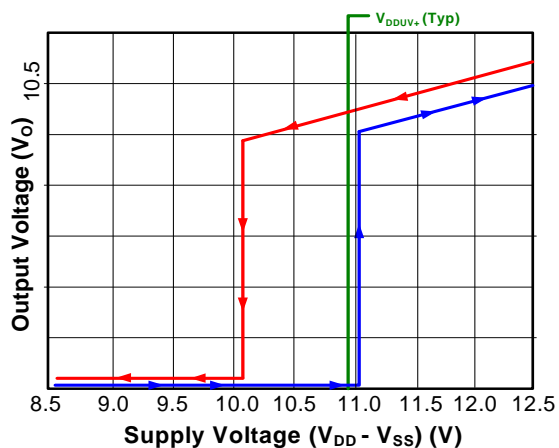

Figure 39. Si823x UVLO Response (10 V)

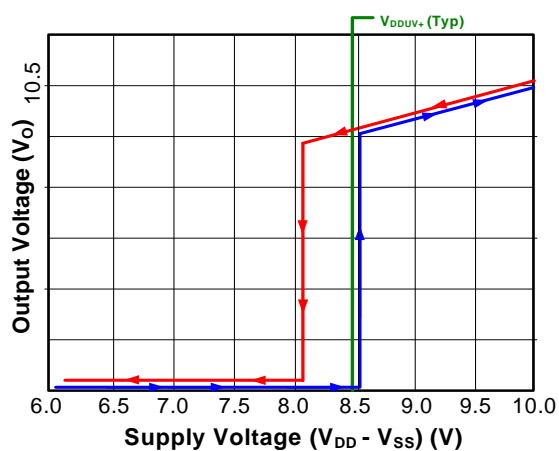

Figure 38. Si823x UVLO Response (8 V)

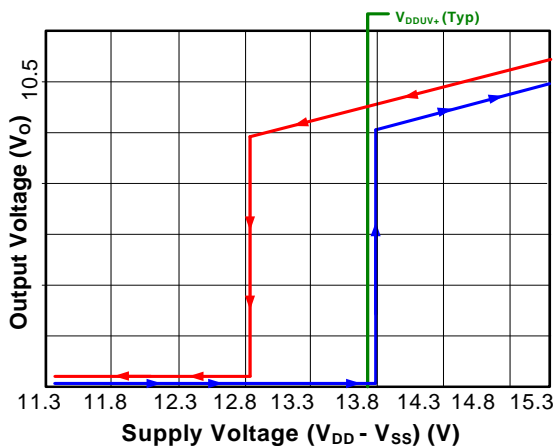

Figure 40. Si823x UVLO Response (12.5 V)

3.7.4. Control Inputs

VIA, VIB, and PWM inputs are high-true, TTL level-compatible logic inputs. A logic high signal on VIA or VIB causes the corresponding output to go high. For PWM input versions (Si8231/4), VOA is high and VOB is low when the PWM input is high, and VOA is low and VOB is high when the PWM input is low.

3.7.5. Disable Input

When brought high, the DISABLE input unconditionally drives VOA and VOB low regardless of the states of VIA and VIB. Device operation terminates within t_{SD} after $DISABLE = V_{IH}$ and resumes within $t_{RESTART}$ after $DISABLE = V_{IL}$. The DISABLE input has no effect if VDDI is below its UVLO level (i.e., VOA, VOB remain low).

3.8. Programmable Dead Time and Overlap Protection

All high-side/low-side drivers (Si8230/1/3/4) include programmable overlap protection to prevent outputs VOA and VOB from being high at the same time. These devices also include programmable dead time, which adds a user-programmable delay between transitions of VOA and VOB. When enabled, dead time is present on all transitions, even after overlap recovery. The amount of dead time delay (DT) is programmed by a single resistor (RDT) connected from the DT input to ground per Equation 5. Note that the dead time pin can be tied to VDDI or left floating to provide a nominal dead time at approximately 400 ps.

$$DT \approx 10 \times RDT$$

where:
 DT= dead time (ns)
 and
 RDT= dead time programming resistor (k Ω)

Equation 5.

The device driving VIA and VIB should provide a minimum dead time of TDD to avoid activating overlap protection. Input/output timing waveforms for the two-input drivers are shown in Figure 41, and dead time waveforms are shown in Figure 42.



Figure 41. Input / Output Waveforms for High-Side / Low-Side Two-Input Drivers

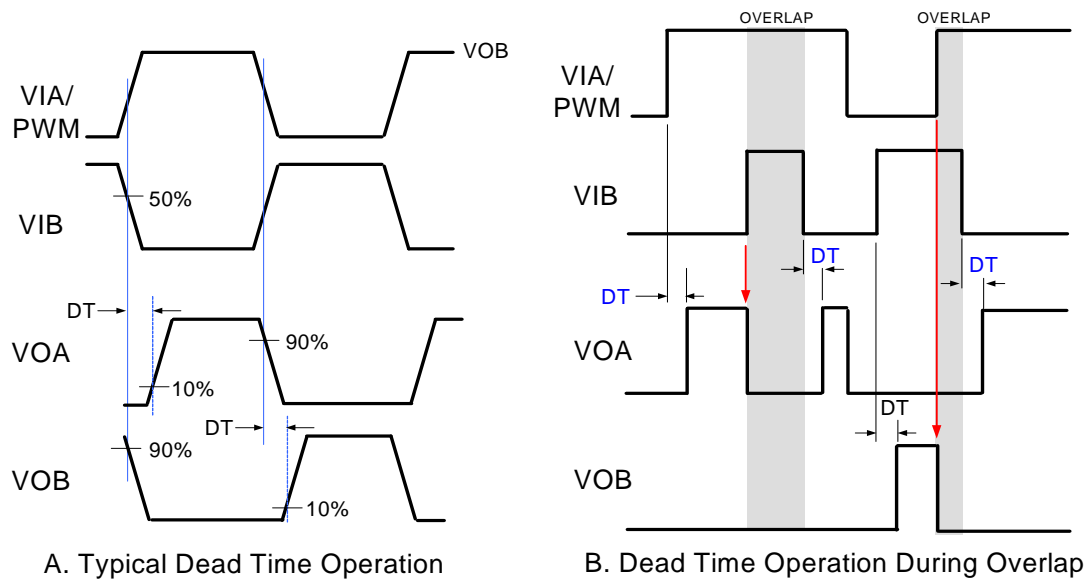

Figure 42. Dead Time Waveforms for High-Side/Low-Side Two-Input Drivers

4. Applications

The following examples illustrate typical circuit configurations using the Si823x.

4.1. High-Side/Low-Side Driver

Figure 43A shows the Si8230/3 controlled using the VIA and VIB input signals, and Figure 43B shows the Si8231/4 controlled by a single PWM signal.



Figure 43. Si823x in Half-Bridge Application

For both cases, D1 and C2 form a conventional bootstrap circuit that allows VOA to operate as a high-side driver for Q1, which has a maximum drain voltage of 1500 V. VOB is connected as a conventional low-side driver. Note that the input side of the Si823x requires VDD in the range of 4.5 to 5.5 V (2.7 to 5.5 V for Si8237/8), while the VDDA and VDDDB output side supplies must be between 6.5 and 24 V with respect to their respective grounds. The boot-strap start up time will depend on the C2 cap chosen. VDD2 is usually the same as VDDDB. Also note that the bypass capacitors on the Si823x should be located as close to the chip as possible. Moreover, it is recommended that 0.1 and 10 μF bypass capacitors be used to reduce high frequency noise and maximize performance.

4.2. Dual Driver

Figure 44 shows the Si823x configured as a dual driver. Note that the drain voltages of Q1 and Q2 can be referenced to a common ground or to different grounds with as much as 1500 V dc between them.



Figure 44. Si8232/5/7/8 in a Dual Driver Application

Because each output driver resides on its own die, the relative voltage polarities of VOA and VOB can reverse without damaging the driver. That is, the voltage at VOA can be higher or lower than that of VOB by VDD without damaging the driver. Therefore, a dual driver in a low-side high side/low side drive application can use either VOA or VOB as the high side driver. Similarly, a dual driver can operate as a dual low-side or dual high-side driver and is unaffected by static or dynamic voltage polarity changes.

4.3. Dual Driver with Thermally Enhanced Package (Si8236)

The thermal pad of the Si8236 must be connected to a heat spreader to lower thermal resistance. Generally, the larger the thermal shield's area, the lower the thermal resistance. It is recommended that thermal vias also be used to add mass to the shield. Vias generally have much more mass than the shield alone and consume less space, thus reducing thermal resistance more effectively. While the heat spreader is not generally a circuit ground, it is a good reference plane for the Si8236 and is also useful as a shield layer for EMI reduction.

With a 10mm² thermal plane on the outer layers (including 20 thermal vias), the thermal impedance of the Si8236 was measured at 50 °C/W. This is a significant improvement over the Si8235 which does not include a thermal pad. The Si8235's thermal resistance was measured at 105 °C /W. In addition, note that the GNDA and GNDB pins for the Si8236 are connected together through the thermal pad.

5. Pin Descriptions

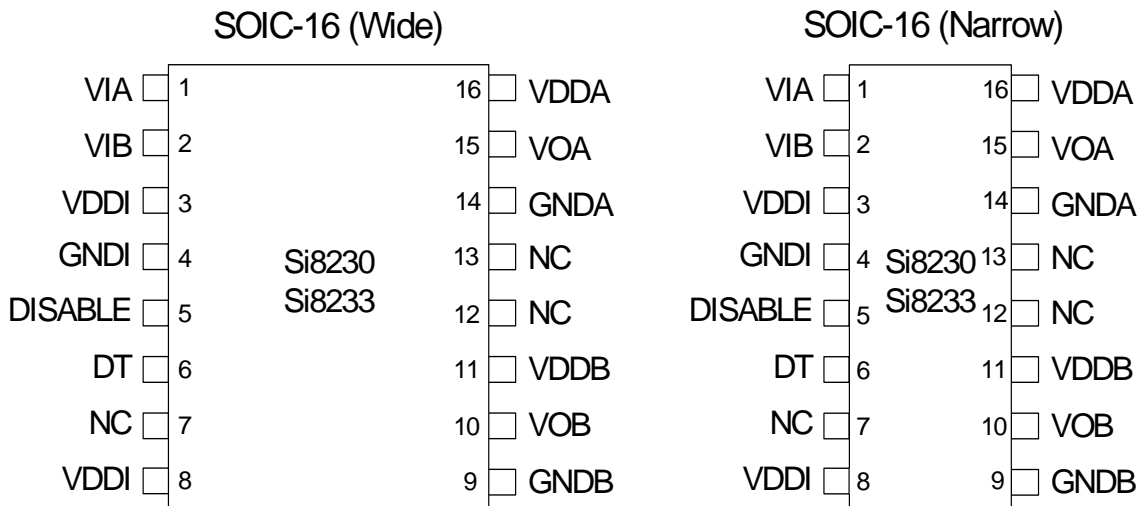

Table 11. Si8230/3 Two-Input HS/LS Isolated Driver (SOIC-16)

| Pin | Name | Description |
|-----|---------|--|
| 1 | VIA | Non-inverting logic input terminal for Driver A. |
| 2 | VIB | Non-inverting logic input terminal for Driver B. |
| 3 | VDDI | Input-side power supply terminal; connect to a source of 4.5 to 5.5 V. |
| 4 | GNDI | Input-side ground terminal. |
| 5 | DISABLE | Device Disable. When high, this input unconditionally drives outputs VOA, VOB LOW. It is strongly recommended that this input be connected to external logic level to avoid erroneous operation due to capacitive noise coupling. |
| 6 | DT | Dead time programming input. The value of the resistor connected from DT to ground sets the dead time between output transitions of VOA and VOB. Defaults to 400 ps dead time when connected to VDDI or left open (see "3.8. Programmable Dead Time and Overlap Protection" on page 28). |
| 7 | NC | No connection. |
| 8 | VDDI | Input-side power supply terminal; connect to a source of 4.5 to 5.5 V. |
| 9 | GNDB | Ground terminal for Driver B. |
| 10 | VOB | Driver B output (low-side driver). |
| 11 | VDDB | Driver B power supply voltage terminal; connect to a source of 6.5 to 24 V. |
| 12 | NC | No connection. |
| 13 | NC | No connection. |
| 14 | GNDA | Ground terminal for Driver A. |
| 15 | VOA | Driver A output (high-side driver). |
| 16 | VDDA | Driver A power supply voltage terminal; connect to a source of 6.5 to 24 V. |

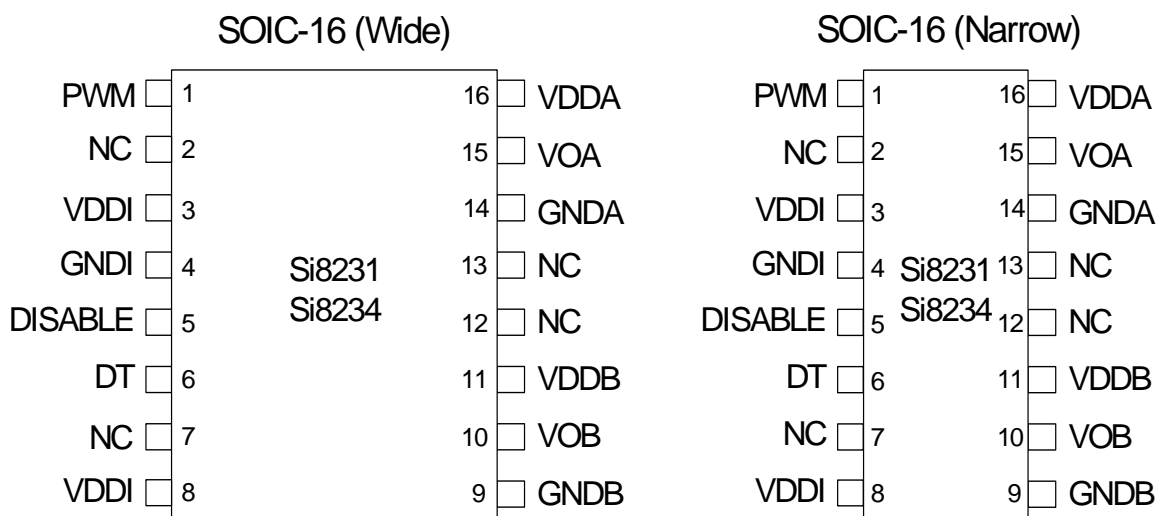

Table 12. Si8231/4 PWM Input HS/LS Isolated Driver (SOIC-16)

| Pin | Name | Description |
|-----|---------|--|
| 1 | PWM | PWM input. |
| 2 | NC | No connection. |
| 3 | VDDI | Input-side power supply terminal; connect to a source of 4.5 to 5.5 V. |
| 4 | GNDI | Input-side ground terminal. |
| 5 | DISABLE | Device Disable. When high, this input unconditionally drives outputs VOA, VOB LOW. It is strongly recommended that this input be connected to external logic level to avoid erroneous operation due to capacitive noise coupling. |
| 6 | DT | Dead time programming input. The value of the resistor connected from DT to ground sets the dead time between output transitions of VOA and VOB. Defaults to 400 ps dead time when connected to VDDI or left open (see "3.8. Programmable Dead Time and Overlap Protection" on page 28). |
| 7 | NC | No connection. |
| 8 | VDDI | Input-side power supply terminal; connect to a source of 4.5 to 5.5 V. |
| 9 | GNDB | Ground terminal for Driver B. |
| 10 | VOB | Driver B output (low-side driver). |
| 11 | VDDDB | Driver B power supply voltage terminal; connect to a source of 6.5 to 24 V. |
| 12 | NC | No connection. |
| 13 | NC | No connection. |
| 14 | GNDA | Ground terminal for Driver A. |
| 15 | VOA | Driver A output (high-side driver). |
| 16 | VDDA | Driver A power supply voltage terminal; connect to a source of 6.5 to 24 V. |

Si823x

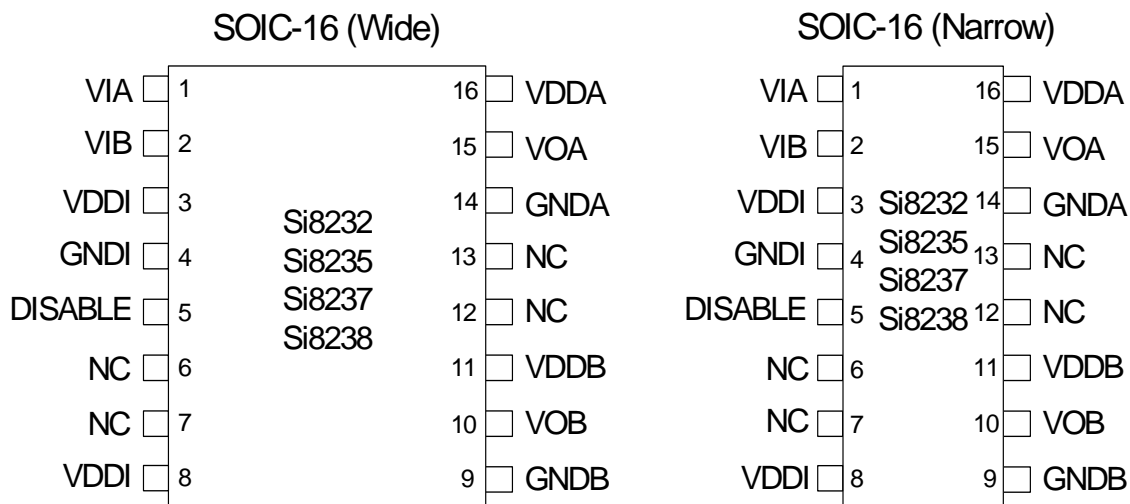

Table 13. Si8232/5/7/8 Dual Isolated Driver (SOIC-16)

| Pin | Name | Description |
|-----|---------|---|
| 1 | VIA | Non-inverting logic input terminal for Driver A. |
| 2 | VIB | Non-inverting logic input terminal for Driver B. |
| 3 | VDDI | Input-side power supply terminal; connect to a source of 4.5 to 5.5 V, (2.7 to 5.5 V for Si8237/8). |
| 4 | GNDI | Input-side ground terminal. |
| 5 | DISABLE | Device Disable. When high, this input unconditionally drives outputs VOA, VOB LOW. It is strongly recommended that this input be connected to external logic level to avoid erroneous operation due to capacitive noise coupling. |
| 6 | NC | No connection. |
| 7 | NC | No connection. |
| 8 | VDDI | Input-side power supply terminal; connect to a source of 4.5 to 5.5 V, (2.7 to 5.5 V for Si8237/8). |
| 9 | GNDB | Ground terminal for Driver B. |
| 10 | VOB | Driver B output. |
| 11 | VDDDB | Driver B power supply voltage terminal; connect to a source of 6.5 to 24 V. |
| 12 | NC | No connection. |
| 13 | NC | No connection. |
| 14 | GNDA | Ground terminal for Driver A. |
| 15 | VOA | Driver A output. |
| 16 | VDDA | Driver A power supply voltage terminal; connect to a source of 6.5 to 24 V. |

LGA-14 (5 x 5 mm)



Table 14. Si8233 Two-Input HS/LS Isolated Driver (14 LD LGA)

| Pin | Name | Description |
|---------|------|--|
| GNDI | 1 | Input-side ground terminal. |
| VIA | 2 | Non-inverting logic input terminal for Driver A. |
| VIB | 3 | Non-inverting logic input terminal for Driver B. |
| VDDI | 4 | Input-side power supply terminal; connect to a source of 4.5 to 5.5 V. |
| DISABLE | 5 | Device Disable. When high, this input unconditionally drives outputs VOA, VOB LOW. It is strongly recommended that this input be connected to external logic level to avoid erroneous operation due to capacitive noise coupling. |
| DT | 6 | Dead time programming input. The value of the resistor connected from DT to ground sets the dead time between output transitions of VOA and VOB. Defaults to 400 ps dead time when connected to VDDI or left open (see "3.8. Programmable Dead Time and Overlap Protection" on page 28). |
| VDDI | 7 | Input-side power supply terminal; connect to a source of 4.5 to 5.5 V. |
| GNDB | 8 | Ground terminal for Driver B. |
| VOB | 9 | Driver B output (low-side driver). |
| VDDDB | 10 | Driver B power supply voltage terminal; connect to a source of 6.5 to 24 V. |
| NC | 11 | No connection. |
| GNDA | 12 | Ground terminal for Driver A. |
| VOA | 13 | Driver A output (high-side driver). |
| VDDA | 14 | Driver A power supply voltage terminal; connect to a source of 6.5 to 24 V. |

LGA-14 (5 x 5 mm)

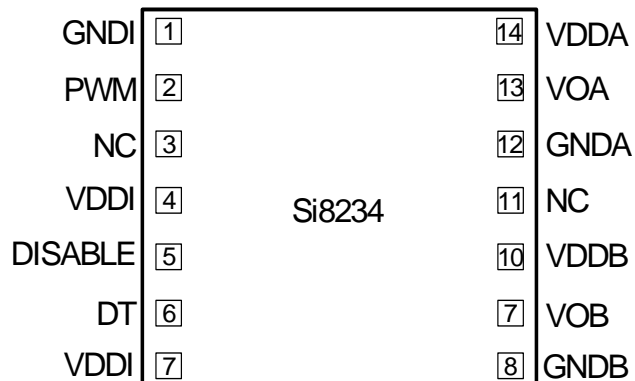

Table 15. Si8234 PWM Input HS/LS Isolated Driver (14 LD LGA)

| Pin | Name | Description |
|---------|------|--|
| GNDI | 1 | Input-side ground terminal. |
| PWM | 2 | PWM input. |
| NC | 3 | No connection. |
| VDDI | 4 | Input-side power supply terminal; connect to a source of 4.5 to 5.5 V. |
| DISABLE | 5 | Device Disable. When high, this input unconditionally drives outputs VOA, VOB LOW. It is strongly recommended that this input be connected to external logic level to avoid erroneous operation due to capacitive noise coupling. |
| DT | 6 | Dead time programming input. The value of the resistor connected from DT to ground sets the dead time between output transitions of VOA and VOB. Defaults to 400 ps dead time when connected to VDDI or left open (see "3.8. Programmable Dead Time and Overlap Protection" on page 28). |
| VDDI | 7 | Input-side power supply terminal; connect to a source of 4.5 to 5.5 V. |
| GNDB | 8 | Ground terminal for Driver B. |
| VOB | 9 | Driver B output (low-side driver). |
| VDDB | 10 | Driver B power supply voltage terminal; connect to a source of 6.5 to 24 V. |
| NC | 11 | No connection. |
| GNDA | 12 | Ground terminal for Driver A. |
| VOA | 13 | Driver A output (high-side driver). |
| VDDA | 14 | Driver A power supply voltage terminal; connect to a source of 6.5 to 24 V. |

LGA-14 (5 x 5 mm)

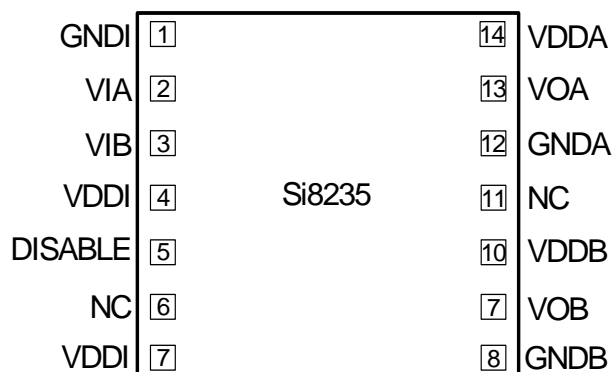

Table 16. Si8235 Dual Isolated Driver (14 LD LGA)

| Pin | Name | Description |
|---------|------|---|
| GNDI | 1 | Input-side ground terminal. |
| VIA | 2 | Non-inverting logic input terminal for Driver A. |
| VIB | 3 | Non-inverting logic input terminal for Driver B. |
| VDDI | 4 | Input-side power supply terminal; connect to a source of 4.5 to 5.5 V. |
| DISABLE | 5 | Device Disable. When high, this input unconditionally drives outputs VOA, VOB LOW. It is strongly recommended that this input be connected to external logic level to avoid erroneous operation due to capacitive noise coupling. |
| NC | 6 | No connection. |
| VDDI | 7 | Input-side power supply terminal; connect to a source of 4.5 to 5.5 V. |
| GNDB | 8 | Ground terminal for Driver B. |
| VOB | 9 | Driver B output (low-side driver). |
| VDDB | 10 | Driver B power supply voltage terminal; connect to a source of 6.5 to 24 V. |
| NC | 11 | No connection. |
| GNDA | 12 | Ground terminal for Driver A. |
| VOA | 13 | Driver A output (high-side driver). |
| VDDA | 14 | Driver A power supply voltage terminal; connect to a source of 6.5 to 24 V. |

LGA-14 (5 x 5 mm)



Table 17. Si8236 Dual Isolated Driver (14 LD LGA)

| Pin | Name | Description |
|---------|------|---|
| GNDI | 1 | Input-side ground terminal. |
| VIA | 2 | Non-inverting logic input terminal for Driver A. |
| VIB | 3 | Non-inverting logic input terminal for Driver B. |
| VDDI | 4 | Input-side power supply terminal; connect to a source of 4.5 to 5.5 V. |
| DISABLE | 5 | Device Disable. When high, this input unconditionally drives outputs VOA, VOB LOW. It is strongly recommended that this input be connected to external logic level to avoid erroneous operation due to capacitive noise coupling. |
| NC | 6 | No connection. |
| VDDI | 7 | Input-side power supply terminal; connect to a source of 4.5 to 5.5 V. |
| GNDB | 8 | Ground terminal for Driver B. GNDA and GNDB pins for the Si8236 are connected together through the thermal pad. |
| VOB | 9 | Driver B output (low-side driver). |
| VDDB | 10 | Driver B power supply voltage terminal; connect to a source of 6.5 to 24 V. |
| NC | 11 | No connection. |
| GNDA | 12 | Ground terminal for Driver A. GNDA and GNDB pins for the Si8236 are connected together through the thermal pad. |
| VOA | 13 | Driver A output (high-side driver). |
| VDDA | 14 | Driver A power supply voltage terminal; connect to a source of 6.5 to 24 V. |

6. Ordering Guide

Table 18. Ordering Part Numbers^{1,2,3}

| Ordering Part Number (OPN) | Inputs | Configuration | Peak Current | UVLO Voltage | Isolation Rating | Temperature Range | Package Type | Legacy Ordering Part Number (OPN) 2.5 kV Only |
|---|----------|------------------------|--------------|--------------|------------------|-------------------|-------------------------|---|
| Wide Body (WB) Package Options | | | | | | | | |
| Si8230BB-B-IS | VIA, VIB | High Side/ Low Side | 0.5 A | 8 V | 2.5 kVrms | -40 to +125 °C | SOIC-16 Wide Body | Si8230-A-IS |
| Si8231BB-B-IS | PWM | High Side/ Low Side | | | | | | Si8231-A-IS |
| Si8232BB-B-IS | VIA, VIB | Dual Driver | | | | | | Si8232-A-IS |
| Si8234CB-C-IS | PWM | High Side/ Low Side | 4.0 A | 10 V | | | | N/A |
| Si8233BB-C-IS | VIA, VIB | High Side/ Low Side | | 8 V | | | | Si8233-B-IS |
| Si8234BB-C-IS | PWM | High Side/ Low Side | | | | | | Si8234-B-IS |
| Si8235BB-C-IS | VIA, VIB | Dual Driver | | Si8235-B-IS | | | | |
| Si8230AB-B-IS | VIA, VIB | High Side/ Low Side | 0.5 A | 5 V | 2.5 kVrms | -40 to +125 °C | SOIC-16 Wide Body | N/A |
| Si8231AB-B-IS | PWM | | | | | | | N/A |
| Si8232AB-B-IS | VIA, VIB | | | | | | | Dual Driver |
| Si8233AB-C-IS | VIA, VIB | High Side/ Low Side | 4.0 A | 5 V | | | | N/A |
| Si8234AB-C-IS | PWM | | | | | | | N/A |
| Si8235AB-C-IS | VIA, VIB | | | | | | | Dual Driver |
| Notes: | | | | | | | | |
| 1. All packages are RoHS-compliant with peak reflow temperatures of 260 °C according to the JEDEC industry standard classifications and peak solder temperatures. | | | | | | | | |
| 2. All devices >1 kV _{RMS} are AEC-Q100 qualified. | | | | | | | | |
| 3. "Si" and "SI" are used interchangeably. | | | | | | | | |

Table 18. Ordering Part Numbers^{1,2,3} (Continued)

| Ordering Part Number (OPN) | Inputs | Configuration | Peak Current | UVLO Voltage | Isolation Rating | Temperature Range | Package Type | Legacy Ordering Part Number (OPN) 2.5 kV Only |
|--|----------|---------------------|--------------|--------------|------------------|-------------------|---------------------|---|
| Narrow Body (NB) Package Options | | | | | | | | |
| Si8230BB-B-IS1 | VIA, VIB | High Side/ Low Side | 0.5 A | 8 V | 2.5 kVrms | -40 to +125 °C | SOIC-16 Narrow Body | N/A |
| Si8231BB-B-IS1 | PWM | High Side/ Low Side | | | | | | |
| Si8232BB-B-IS1 | VIA, VIB | Dual Driver | | | | | | |
| Si8233BB-C-IS1 | VIA, VIB | High Side/ Low Side | 4.0 A | 8 V | 2.5 kVrms | -40 to +125 °C | SOIC-16 Narrow Body | N/A |
| Si8234BB-C-IS1 | PWM | High Side/ Low Side | | | | | | |
| Si8235BB-C-IS1 | VIA, VIB | Dual Driver | | | | | | |
| Si8235BA-C-IS1 | VIA, VIB | Dual Driver | | | 1.0 kVrms | | | |
| Si8230AB-B-IS1 | VIA, VIB | High Side/ Low Side | 0.5 A | 5 V | 2.5 kVrms | -40 to +125 °C | SOIC-16 Narrow Body | N/A |
| Si8231AB-B-IS1 | PWM | High Side/ Low Side | | | | | | N/A |
| Si8232AB-B-IS1 | VIA, VIB | Dual Driver | | | | | | N/A |
| Si8233AB-C-IS1 | VIA, VIB | High Side/ Low Side | 4.0 A | 5 V | 2.5 kVrms | -40 to +125 °C | SOIC-16 Narrow Body | N/A |
| Si8234AB-C-IS1 | PWM | High Side/ Low Side | | | | | | N/A |
| Si8235AB-C-IS1 | VIA, VIB | Dual Driver | | | | | | N/A |
| Notes: | | | | | | | | |
| <ol style="list-style-type: none"> 1. All packages are RoHS-compliant with peak reflow temperatures of 260 °C according to the JEDEC industry standard classifications and peak solder temperatures. 2. All devices >1 kV_{RMS} are AEC-Q100 qualified. 3. "Si" and "SI" are used interchangeably. | | | | | | | | |

Table 18. Ordering Part Numbers^{1,2,3} (Continued)

| Ordering Part Number (OPN) | Inputs | Configuration | Peak Current | UVLO Voltage | Isolation Rating | Temperature Range | Package Type | Legacy Ordering Part Number (OPN) 2.5 kV Only |
|---|----------|------------------------|--------------|--------------|------------------|-------------------|-------------------------|---|
| LGA Package Options | | | | | | | | |
| Si8233CB-C-IM | VIA, VIB | High Side/ Low Side | 4.0 A | 10 V | 2.5 kVrms | -40 to +125 °C | LGA-14 5x5 mm | N/A |
| Si8233BB-C-IM | | | | 8 V | | | | Si8233-B-IM |
| Si8233AB-C-IM | | | | 5 V | | | | N/A |
| Si8234BB-C-IM | PWM | 8 V | | Si8234-B-IM | | | | |
| Si8234AB-C-IM | | 5 V | | N/A | | | | |
| Si8235BB-C-IM | | VIA, VIB | | Dual Driver | | | | 8 V |
| Si8235AB-C-IM | 5 V | | | | N/A | | | |
| Si8236BA-C-IM | 8 V | | | | Si8236-B-IM | | | |
| Si8236AA-C-IM | | | | 5 V | 1.0 kVrms | | | LGA-14 5x5 mm with Thermal Pad |
| 5 kV Ordering Options | | | | | | | | |
| Si8230BD-B-IS | VIA, VIB | High Side/ Low Side | 0.5 A | 8 V | 5.0 kVrms | -40 to +125 °C | SOIC-16 Wide Body | N/A |
| Si8231BD-B-IS | PWM | High Side/ Low Side | | | | | | |
| Si8232BD-B-IS | VIA, VIB | Dual Driver | | | | | | |
| Si8233BD-C-IS | VIA, VIB | High Side/ Low Side | 4.0 A | | | | | |
| Si8234BD-C-IS | PWM | High Side/ Low Side | | | | | | |
| Si8235BD-C-IS | VIA, VIB | Dual Driver | | | | | | |
| Si8230AD-B-IS | VIA, VIB | High Side/ Low Side | 0.5 A | 5 V | 5.0 kVrms | -40 to +125 °C | SOIC-16 Wide Body | N/A |
| Si8231AD-B-IS | PWM | High Side/ Low Side | | | | | | |
| Si8232AD-B-IS | VIA, VIB | Dual Driver | | | | | | |
| Si8233AD-C-IS | VIA, VIB | High Side/ Low Side | 4.0 A | 5 V | | | | |
| Si8234AD-C-IS | PWM | High Side/ Low Side | | | | | | |
| Si8235AD-C-IS | VIA, VIB | Dual Driver | | | | | | |
| Notes: | | | | | | | | |
| 1. All packages are RoHS-compliant with peak reflow temperatures of 260 °C according to the JEDEC industry standard classifications and peak solder temperatures. | | | | | | | | |
| 2. All devices >1 kV _{RMS} are AEC-Q100 qualified. | | | | | | | | |
| 3. "Si" and "SI" are used interchangeably. | | | | | | | | |

Table 18. Ordering Part Numbers^{1,2,3} (Continued)

| Ordering Part Number (OPN) | Inputs | Configuration | Peak Current | UVLO Voltage | Isolation Rating | Temperature Range | Package Type | Legacy Ordering Part Number (OPN) 2.5 kV Only | |
|--|----------|---------------|--------------|--------------|------------------|-------------------|---------------------------|--|-------------------------|
| 3 V VDDI Ordering Options | | | | | | | | | |
| Si8237AB-B-IS1 | VIA, VIB | Dual Driver | 0.5 A | 5 V | 2.5 kVrms | 40 to +125 °C | SOIC-16 Narrow Body | N/A | |
| Si8237BB-B-IS1 | VIA, VIB | Dual Driver | | 8 V | | | | | |
| Si8238AB-C-IS1 | VIA, VIB | Dual Driver | 4.0 A | 5 V | | | | | |
| Si8238BB-C-IS1 | VIA, VIB | Dual Driver | | 8 V | | | | | |
| Si8237AD-B-IS | VIA, VIB | Dual Driver | 0.5 A | 5 V | 5.0 kVrms | | | | SOIC-16 Wide Body |
| Si8237BD-B-IS | VIA, VIB | Dual Driver | | 8 V | | | | | |
| Si8238AD-C-IS | VIA, VIB | Dual Driver | 4.0 A | 5 V | | | | | |
| Si8238BD-C-IS | VIA, VIB | Dual Driver | | 8 V | | | | | |
| Notes: | | | | | | | | | |
| <ol style="list-style-type: none"> 1. All packages are RoHS-compliant with peak reflow temperatures of 260 °C according to the JEDEC industry standard classifications and peak solder temperatures. 2. All devices >1 kV_{RMS} are AEC-Q100 qualified. 3. "Si" and "SI" are used interchangeably. | | | | | | | | | |

7. Package Outline: 16-Pin Wide Body SOIC

Figure 45 illustrates the package details for the Si823x in a 16-Pin Wide Body SOIC. Table 19 lists the values for the dimensions shown in the illustration.



Figure 45. 16-Pin Wide Body SOIC

Table 19. Package Diagram Dimensions

| Dimension | Min | Max |
|--|-----------|------|
| A | — | 2.65 |
| A1 | 0.10 | 0.30 |
| A2 | 2.05 | — |
| b | 0.31 | 0.51 |
| c | 0.20 | 0.33 |
| D | 10.30 BSC | |
| E | 10.30 BSC | |
| E1 | 7.50 BSC | |
| e | 1.27 BSC | |
| L | 0.40 | 1.27 |
| h | 0.25 | 0.75 |
| θ | 0° | 8° |
| aaa | — | 0.10 |
| bbb | — | 0.33 |
| ccc | — | 0.10 |
| ddd | — | 0.25 |
| eee | — | 0.10 |
| fff | — | 0.20 |
| Notes: | | |
| <ol style="list-style-type: none"> 1. All dimensions shown are in millimeters (mm) unless otherwise noted. 2. Dimensioning and Tolerancing per ANSI Y14.5M-1994. 3. This drawing conforms to JEDEC Outline MS-013, Variation AA. 4. Recommended reflow profile per JEDEC J-STD-020 specification for small body, lead-free components. | | |

8. Land Pattern: 16-Pin Wide Body SOIC

Figure 46 illustrates the recommended land pattern details for the Si823x in a 16-pin wide-body SOIC. Table 20 lists the values for the dimensions shown in the illustration.



Figure 46. 16-Pin SOIC Land Pattern

Table 20. 16-Pin Wide Body SOIC Land Pattern Dimensions

| Dimension | Feature | (mm) |
|-----------|--------------------|------|
| C1 | Pad Column Spacing | 9.40 |
| E | Pad Row Pitch | 1.27 |
| X1 | Pad Width | 0.60 |
| Y1 | Pad Length | 1.90 |

Notes:

1. This Land Pattern Design is based on IPC-7351 pattern SOIC127P1032X265-16AN for Density Level B (Median Land Protrusion).
2. All feature sizes shown are at Maximum Material Condition (MMC) and a card fabrication tolerance of 0.05 mm is assumed.

9. Package Outline: 16-Pin Narrow Body SOIC

Figure 47 illustrates the package details for the Si823x in a 16-pin narrow-body SOIC (SO-16). Table 21 lists the values for the dimensions shown in the illustration.



Figure 47. 16-pin Small Outline Integrated Circuit (SOIC) Package

Table 21. Package Diagram Dimensions

| Dimension | Min | Max | Dimension | Min | Max |
|-----------|----------|------|-----------|----------|------|
| A | — | 1.75 | L | 0.40 | 1.27 |
| A1 | 0.10 | 0.25 | L2 | 0.25 BSC | |
| A2 | 1.25 | — | h | 0.25 | 0.50 |
| b | 0.31 | 0.51 | θ | 0° | 8° |
| c | 0.17 | 0.25 | aaa | 0.10 | |
| D | 9.90 BSC | | bbb | 0.20 | |
| E | 6.00 BSC | | ccc | 0.10 | |
| E1 | 3.90 BSC | | ddd | 0.25 | |
| e | 1.27 BSC | | | | |

Notes:

1. All dimensions shown are in millimeters (mm) unless otherwise noted.
2. Dimensioning and Tolerancing per ANSI Y14.5M-1994.
3. This drawing conforms to the JEDEC Solid State Outline MS-012, Variation AC.
4. Recommended card reflow profile is per the JEDEC/IPC J-STD-020 specification for Small Body Components.

10. Land Pattern: 16-Pin Narrow Body SOIC

Figure 48 illustrates the recommended land pattern details for the Si823x in a 16-pin narrow-body SOIC. Table 22 lists the values for the dimensions shown in the illustration.



Figure 48. 16-Pin Narrow Body SOIC PCB Land Pattern

Table 22. 16-Pin Narrow Body SOIC Land Pattern Dimensions

| Dimension | Feature | (mm) |
|--|--------------------|------|
| C1 | Pad Column Spacing | 5.40 |
| E | Pad Row Pitch | 1.27 |
| X1 | Pad Width | 0.60 |
| Y1 | Pad Length | 1.55 |
| Notes: | | |
| <ol style="list-style-type: none"> 1. This Land Pattern Design is based on IPC-7351 pattern SOIC127P600X165-16N for Density Level B (Median Land Protrusion). 2. All feature sizes shown are at Maximum Material Condition (MMC) and a card fabrication tolerance of 0.05 mm is assumed. | | |

11. Package Outline: 14 LD LGA (5 x 5 mm)

Figure 49 illustrates the package details for the Si823x in an LGA outline. Table 23 lists the values for the dimensions shown in the illustration.

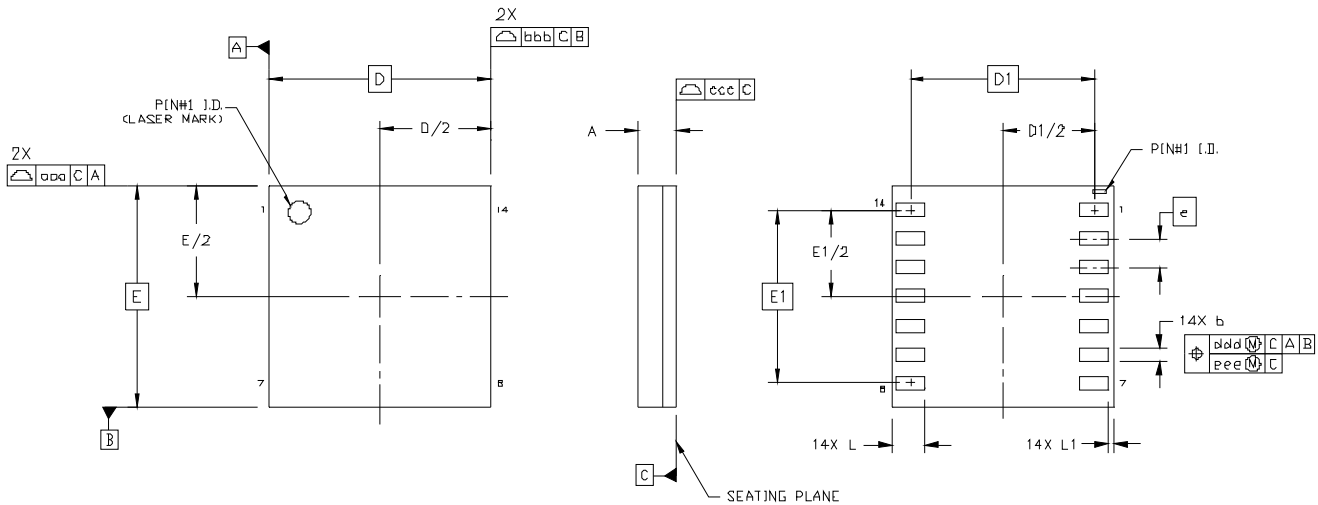

Figure 49. Si823x LGA Outline

Table 23. Package Diagram Dimensions

| Dimension | MIN | NOM | MAX |
|---|----------|------|------|
| A | 0.74 | 0.84 | 0.94 |
| b | 0.25 | 0.30 | 0.35 |
| D | 5.00 BSC | | |
| D1 | 4.15 BSC | | |
| e | 0.65 BSC | | |
| E | 5.00 BSC | | |
| E1 | 3.90 BSC | | |
| L | 0.70 | 0.75 | 0.80 |
| L1 | 0.05 | 0.10 | 0.15 |
| aaa | — | — | 0.10 |
| bbb | — | — | 0.10 |
| ccc | — | — | 0.08 |
| ddd | — | — | 0.15 |
| eee | — | — | 0.08 |
| Notes: | | | |
| 1. All dimensions shown are in millimeters (mm) unless otherwise noted. | | | |
| 2. Dimensioning and Tolerancing per ANSI Y14.5M-1994. | | | |

12. Land Pattern: 14 LD LGA

Figure 50 illustrates the recommended land pattern details for the Si823x in a 14-pin LGA. Table 24 lists the values for the dimensions shown in the illustration.

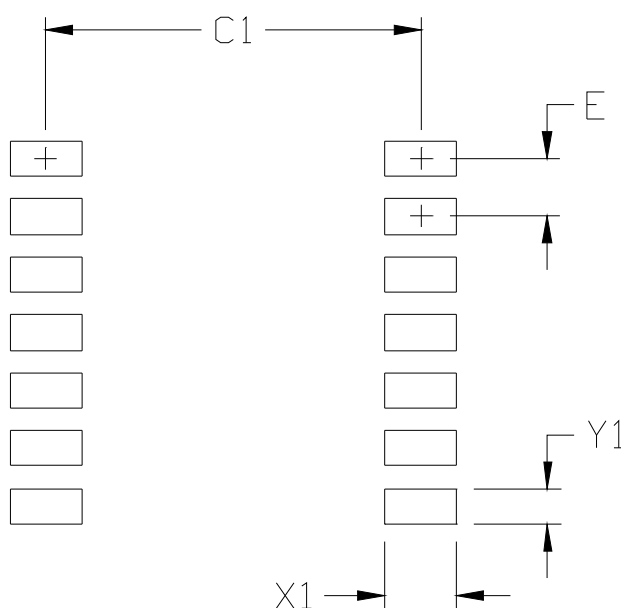

Figure 50. 14-Pin LGA Land Pattern

Table 24. 14-Pin LGA Land Pattern Dimensions

| Dimension | (mm) |
|-----------|------|
| C1 | 4.20 |
| E | 0.65 |
| X1 | 0.80 |
| Y1 | 0.40 |

Notes:

General

1. All dimensions shown are in millimeters (mm).
2. This Land Pattern Design is based on the IPC-7351 guidelines.
3. All dimensions shown are at Maximum Material Condition (MMC). Least Material Condition (LMC) is calculated based on a Fabrication Allowance of 0.05 mm.

Solder Mask Design

4. All metal pads are to be non-solder mask defined (NSMD). Clearance between the solder mask and the metal pad is to be 60 μm minimum, all the way around the pad.

Stencil Design

5. A stainless steel, laser-cut and electro-polished stencil with trapezoidal walls should be used to assure good solder paste release.
6. The stencil thickness should be 0.125 mm (5 mils).
7. The ratio of stencil aperture to land pad size should be 1:1.

Card Assembly

8. A No-Clean, Type-3 solder paste is recommended.
9. The recommended card reflow profile is per the JEDEC/IPC J-STD-020 specification for Small Body Components.

13. Package Outline: 14 LD LGA with Thermal Pad (5 x 5 mm)

Figure 51 illustrates the package details for the Si8236 ISOdriver in an LGA outline. Table 25 lists the values for the dimensions shown in the illustration.



Figure 51. Si823x LGA Outline with Thermal Pad

Table 25. Package Diagram Dimensions

| Dimension | MIN | NOM | MAX |
|---|----------|------|------|
| A | 0.74 | 0.84 | 0.94 |
| b | 0.25 | 0.30 | 0.35 |
| D | 5.00 BSC | | |
| D1 | 4.15 BSC | | |
| e | 0.65 BSC | | |
| E | 5.00 BSC | | |
| E1 | 3.90 BSC | | |
| L | 0.70 | 0.75 | 0.80 |
| L1 | 0.05 | 0.10 | 0.15 |
| P1 | 1.40 | 1.45 | 1.50 |
| P2 | 4.15 | 4.20 | 4.25 |
| aaa | — | — | 0.10 |
| bbb | — | — | 0.10 |
| ccc | — | — | 0.08 |
| ddd | — | — | 0.15 |
| eee | — | — | 0.08 |
| Notes: | | | |
| 1. All dimensions shown are in millimeters (mm) unless otherwise noted. | | | |
| 2. Dimensioning and Tolerancing per ANSI Y14.5M-1994. | | | |

14. Land Pattern: 14 LD LGA with Thermal Pad

Figure 52 illustrates the recommended land pattern details for the Si8236 in a 14-pin LGA with thermal pad. Table 26 lists the values for the dimensions shown in the illustration.



Figure 52. 14-Pin LGA with Thermal Pad Land Pattern

Table 26. 14-Pin LGA with Thermal Pad Land Pattern Dimensions

| Dimension | (mm) |
|-----------|------|
| C1 | 4.20 |
| C2 | 1.50 |
| D2 | 4.25 |
| E | 0.65 |
| X1 | 0.80 |
| Y1 | 0.40 |

Notes:

General:

1. All dimensions shown are in millimeters (mm).
2. This Land Pattern Design is based on the IPC-7351 guidelines.
3. All dimensions shown are at Maximum Material Condition (MMC). Least Material Condition (LMC) is calculated based on a Fabrication Allowance of 0.05 mm.

Solder Mask Design:

4. All metal pads are to be non-solder mask defined (NSMD). Clearance between the solder mask and the metal pad is to be 60 μm minimum, all the way around the pad.

Stencil Design:

5. A stainless steel, laser-cut and electro-polished stencil with trapezoidal walls should be used to assure good solder paste release.
6. The stencil thickness should be 0.125 mm (5 mils).
7. The ratio of stencil aperture to land pad size should be 1:1.

Card Assembly:

8. A No-Clean, Type-3 solder paste is recommended.
9. The recommended card reflow profile is per the JEDEC/IPC J-STD-020 specification for Small Body Components.

Si823x

15. Top Markings

15.1. Si823x Top Marking (16-Pin Wide Body SOIC)



15.2. Top Marking Explanation (16-Pin Wide Body SOIC)

| | | |
|------------------------|--|---|
| Line 1 Marking: | Base Part Number Ordering Options | Si823 = ISOdriver product series Y = Peak output current ■ 0, 1, 2, 7 = 0.5 A ■ 3, 4, 5, 8 = 4.0 A |
| | See Ordering Guide for more information. | U = UVLO level ■ A = 5 V; B = 8 V; C = 10 V; D = 12.5 V V = Isolation rating ■ B = 2.5 kV; C = 3.75 kV; D = 5.0 kV |
| Line 2 Marking: | YY = Year WW = Workweek | Assigned by the Assembly House. Corresponds to the year and workweek of the mold date. |
| | TTTTTT = Mfg Code | Manufacturing Code from Assembly Purchase Order form. |
| Line 3 Marking: | Circle = 1.5 mm Diameter (Center Justified) | "e4" Pb-Free Symbol |
| | Country of Origin ISO Code Abbreviation | TW = Taiwan |

15.3. Si823x Top Marking (16-Pin Narrow Body SOIC)



15.4. Top Marking Explanation (16-Pin Narrow Body SOIC)

| | | |
|------------------------|--|--|
| Line 1 Marking: | Base Part Number Ordering Options | Si823 = ISOdriver product series Y = Peak output current ■ 0, 1, 2, 7 = 0.5 A ■ 3, 4, 5, 8 = 4.0 A U = UVLO level ■ A = 5 V; B = 8 V; C = 10 V; D = 12.5 V V = Isolation rating ■ B = 2.5 kV; C = 3.75 kV; D = 5.0 kV |
| | See Ordering Guide for more information. | |
| Line 2 Marking: | YY = Year WW = Workweek | Assigned by the Assembly House. Corresponds to the year and workweek of the mold date. |
| | TTTTTT = Mfg Code | Manufacturing Code from Assembly Purchase Order form. |

Si823x

15.5. Si823x Top Marking (14 LD LGA)



15.6. Top Marking Explanation (14 LD LGA)

| | | |
|------------------------|--|---|
| Line 1 Marking: | Base Part Number Ordering Options See Ordering Guide for more information. | Si823 = ISOdriver product series Y = Peak output current ■ 0, 1, 2 = 0.5 A ■ 3, 4, 5, 6 = 4.0 A |
| Line 2 Marking: | Ordering options | U = UVLO level ■ A = 5 V; B = 8 V; C = 10 V; D = 12.5 V V = Isolation rating ■ A = 1.0 kV; B = 2.5 kV; C = 3.75 kV; D = 5.0 kV I = -40 to +125 °C ambient temperature range M = LGA package type |
| Line 3 Marking: | TTTTTT | Manufacturing Code from Assembly |
| Line 4 Marking: | Circle = 1.5 mm diameter | Pin 1 identifier |
| | YYWW | Manufacturing date code |

DOCUMENT CHANGE LIST

Revision 0.11 to Revision 0.2

- Updated all specs to reflect latest silicon revision.
- Updated Table 1 on page 6 to include new UVLO options.
- Updated Table 8 on page 14 to reflect new maximum package isolation ratings
- Added Figures 34, 35, and 36.
- Updated Ordering Guide to reflect new package offerings.
- Added "3.7.3. Undervoltage Lockout (UVLO)" on page 27 to describe UVLO operation.

Revision 0.2 to Revision 0.3

- Moved Sections 2, 3, and 4 to after Section 5.
- Updated Tables 14, 15, and 17.
 - Removed Si8230, Si8231, and Si8232 from pinout and from title.
- Updated and added Ordering Guide footnotes.
- Updated UVLO specifications in Table 1 on page 6.
- Added PWD and Output Supply Active Current specifications in Table 1.
- Updated and added typical operating condition graphs in "3.1. Typical Operating Characteristics (0.5 Amp)" on page 17 and "3.2. Typical Operating Characteristics (4.0 Amp)" on page 19.

Revision 0.3 to Revision 1.0

- Updated Tables 2, 3, 4, and 5.
- Updated "6. Ordering Guide" .
 - Added 5 V UVLO ordering options
- Added Device Marking sections.

Revision 1.0 to Revision 1.1

- Updated " Features" on page 1.
 - Updated CMTI specification.
- Updated Table 1 on page 6.
 - Updated CMTI specification.
- Updated Table 5, "IEC 60747-5-5 Insulation Characteristics*," on page 13.
- Updated "4.2. Dual Driver" on page 31.
- Updated "6. Ordering Guide" on page 39.
- Replaced pin descriptions on page 1 with chip graphics.

Revision 1.1 to Revision 1.2

- Updated "6. Ordering Guide" on page 39.
 - Updated moisture sensitivity level (MSL) for all package types.

- Updated Table 8 on page 14.
 - Added junction temperature spec.
- Updated Table 2 on page 11 with new notes.
- Added Table 17 and pinout.
- Updated Figures 19, 20, 21, and 22 to reflect correct y-axis scaling.
- Updated Figure 44 on page 31.
- Updated "4.3. Dual Driver with Thermally Enhanced Package (Si8236)" on page 31.
- Updated "7. Package Outline: 16-Pin Wide Body SOIC" on page 43.
- Updated Table 19, "Package Diagram Dimensions," on page 44.
- Change references to 1.5 kV_{RMS} rated devices to 1.0 kV_{RMS} throughout.
- Updated "3.5. Power Dissipation Considerations" on page 23.

Revision 1.2 to Revision 1.3

- Added Si8237/8 throughout.
- Updated Table 1 on page 6.
- Updated Figure 4 on page 9.
- Updated Figure 5 on page 9.
- Added Figure 6 on page 10.
- Updated Table 10 on page 21.
 - Created Notes 1 and 2.
- Updated "3.8. Programmable Dead Time and Overlap Protection" on page 28.
 - Removed references to Figures 26A and 26B.
- Updated Table 18 on page 39.
 - Added Si8235-BA-C-IS1 ordering part number.
 - Added table note.

Revision 1.3 to Revision 1.4

- Updated "6. Ordering Guide" on page 39.
 - Updated " 3 V VDDI Ordering Options" .

Revision 1.4 to Revision 1.5

- Updated Table 1, input and output supply current.
- Added references to AEC-Q100 qualified throughout.
- Changed all 60747-5-2 references to 60747-5-5.
- Added references to CQC throughout.
- Updated pin descriptions throughout.
 - Corrected dead time default to 400 ps from 1 ns.
- Updated Table 18, Ordering Part Numbers.
 - Removed moisture sensitivity level table notes.

CONTACT INFORMATION

Silicon Laboratories Inc.

400 West Cesar Chavez
Austin, TX 78701
Tel: 1+(512) 416-8500
Fax: 1+(512) 416-9669
Toll Free: 1+(877) 444-3032

Please visit the Silicon Labs Technical Support web page:
<https://www.silabs.com/support/pages/contacttechnicalsupport.aspx>
and register to submit a technical support request.

Patent Notice



Silicon Labs invests in research and development to help our customers differentiate in the market with innovative low-power, small size, analog-intensive mixed-signal solutions. Silicon Labs' extensive patent portfolio is a testament to our unique approach and world-class engineering team.

The information in this document is believed to be accurate in all respects at the time of publication but is subject to change without notice. Silicon Laboratories assumes no responsibility for errors and omissions, and disclaims responsibility for any consequences resulting from the use of information included herein. Additionally, Silicon Laboratories assumes no responsibility for the functioning of undescribed features or parameters. Silicon Laboratories reserves the right to make changes without further notice. Silicon Laboratories makes no warranty, representation or guarantee regarding the suitability of its products for any particular purpose, nor does Silicon Laboratories assume any liability arising out of the application or use of any product or circuit, and specifically disclaims any and all liability, including without limitation consequential or incidental damages. Silicon Laboratories products are not designed, intended, or authorized for use in applications intended to support or sustain life, or for any other application in which the failure of the Silicon Laboratories product could create a situation where personal injury or death may occur. Should Buyer purchase or use Silicon Laboratories products for any such unintended or unauthorized application, Buyer shall indemnify and hold Silicon Laboratories harmless against all claims and damages.

Silicon Laboratories and Silicon Labs are trademarks of Silicon Laboratories Inc.
Other products or brandnames mentioned herein are trademarks or registered trademarks of their respective holders.

Looking for pricing, stock, or lifecycle information?

Click below to explore more details on WIN SOURCE:

-  [View S18233BB-C-IS1 on WIN SOURCE](#)
-  [Skyworks Solutions Inc. Information](#)

Optimize Your Supply Chain with WIN SOURCE Solutions

-  Global Sourcing Solution
-  Obsolete Management
-  Cost Control Management
-  Shortage Management
-  Alternative Solution
-  Excess Inventory Management