



**THE DATASHEET OF  
SI8635BC-B-ISR**



# Si8630/31/35 Data Sheet

## Low-Power Triple-Channel Digital Isolators

Skyworks' family of ultra-low-power digital isolators are CMOS devices offering substantial data rate, propagation delay, power, size, reliability, and external BOM advantages over legacy isolation technologies. The operating parameters of these products remain stable across wide temperature ranges and throughout device service life for ease of design and highly uniform performance. All device versions have Schmitt trigger inputs for high noise immunity and only require VDD bypass capacitors.

Data rates up to 150 Mbps are supported, and all devices achieve propagation delays of less than 10 ns. Ordering options include a choice of isolation ratings (2.5, 3.75 and 5 kV) and a selectable fail-safe operating mode to control the default output state during power loss. All products are safety certified by UL, CSA, VDE, and CQC, and products in wide-body packages support reinforced insulation withstanding up to 5 kV<sub>RMS</sub>.

Automotive Grade is available for certain part numbers. These products are built using automotive-specific flows at all steps in the manufacturing process to ensure the robustness and low defectivity required for automotive applications.

### Industrial Applications

- Industrial automation systems
- Medical electronics
- Isolated switch mode supplies
- Isolated ADC, DAC
- Motor control
- Power inverters
- Communications systems

### Automotive Applications

- On-board chargers
- Battery management systems
- Charging stations
- Traction inverters
- Hybrid Electric Vehicles
- Battery Electric Vehicles

### Safety Regulatory Approvals

- UL 1577 recognized
  - Up to 5000 V<sub>RMS</sub> for 1 minute
- CSA component notice 5A approval
  - IEC 60950-1, 61010-1, 60601-1 (reinforced insulation)
- VDE certification conformity
  - Si862xxT options certified to reinforced VDE 0884-10
  - All other options certified to IEC 60747-5-5 and reinforced 60950-1
- CQC certification approval
  - GB4943.1

### KEY FEATURES

- High-speed operation
  - DC to 150 Mbps
- No start-up initialization required
- Wide Operating Supply Voltage
  - 2.5–5.5 V
- Up to 5000 V<sub>RMS</sub> isolation
- Reinforced VDE 0884-10, 10 kV surge-capable (Si862xxT)
- 60-year life at rated working voltage
- High electromagnetic immunity
- Ultra low power (typical)
  - 5 V Operation
    - 1.6 mA per channel at 1 Mbps
    - 5.5 mA per channel at 100 Mbps
  - 2.5 V Operation
    - 1.5 mA per channel at 1 Mbps
    - 3.5 mA per channel at 100 Mbps
- Schmitt trigger inputs
- Selectable fail-safe mode
  - Default high or low output (ordering option)
- Precise timing (typical)
  - 10 ns propagation delay
  - 1.5 ns pulse width distortion
  - 0.5 ns channel-channel skew
  - 2 ns propagation delay skew
  - 5 ns minimum pulse width
- Transient Immunity 50 kV/μs
- AEC-Q100 qualification
- Wide temperature range
  - –40 to 125 °C
- RoHS-compliant packages
  - SOIC-16 wide body
  - SOIC-16 narrow body
- Automotive-grade OPNs available
  - AIAG compliant PPAP documentation support
  - IMDS and CAMDS listing support

## 1. Ordering Guide

### Industrial and Automotive Grade OPNs

Industrial-grade devices (part numbers having an “-I” in their suffix) are built using well-controlled, high-quality manufacturing flows to ensure robustness and reliability. Qualifications are compliant with JEDEC, and defect reduction methodologies are used throughout definition, design, evaluation, qualification, and mass production steps.

Automotive-grade devices (part numbers having an “-A” in their suffix) are built using automotive-specific flows at all steps in the manufacturing process to ensure robustness and low defectivity. These devices are supported with AIAG-compliant Production Part Approval Process (PPAP) documentation, and feature International Material Data System (IMDS) and China Automotive Material Data System (CAMDS) listing. Qualifications are compliant with AEC-Q100, and a zero-defect methodology is maintained throughout definition, design, evaluation, qualification, and mass production steps.

**Table 1.1. Ordering Guide for Valid OPNs<sup>1, 2, 4</sup>**

Ordering Part Number (OPN)	Automotive OPNs <sup>5, 6</sup>	Number of Inputs VDD1 Side	Number of Inputs VDD2 Side	Max Data Rate (Mbps)	Default Output State	Isolation Rating (kVrms)	Package
Si8630BB-B-IS	Si8630BB-AS	3	0	150	Low	2.5	WB SOIC-16
Si8630BB-B-IS1	Si8630BB-AS1	3	0	150	Low	2.5	NB SOIC-16
Si8630BC-B-IS1	Si8630BC-AS1	3	0	150	Low	3.75	NB SOIC-16
Si8630EC-B-IS1	Si8630EC-AS1	3	0	150	High	3.75	NB SOIC-16
Si8630BD-B-IS	Si8630BD-AS	3	0	150	Low	5.0	WB SOIC-16
Si8630ED-B-IS	Si8630ED-AS	3	0	150	High	5.0	WB SOIC-16
Si8631BB-B-IS	Si8631BB-AS	2	1	150	Low	2.5	WB SOIC-16
Si8631BB-B-IS1	Si8631BB-AS1	2	1	150	Low	2.5	NB SOIC-16
Si8631BC-B-IS1	Si8631BC-AS1	2	1	150	Low	3.75	NB SOIC-16
Si8631EC-B-IS1	Si8631EC-AS1	2	1	150	High	3.75	NB SOIC-16
Si8631BD-B-IS	Si8631BD-AS	2	1	150	Low	5.0	WB SOIC-16
Si8631ED-B-IS	Si8631ED-AS	2	1	150	High	5.0	WB SOIC-16
Si8635BB-B-IS	Si8635BB-AS	3	0	150	Low	2.5	WB SOIC-16
Si8635BC-B-IS1	Si8635BC-AS1	3	0	150	Low	3.75	NB SOIC-16
Si8635BD-B-IS	Si8635BD-AS	3	0	150	Low	5.0	WB SOIC-16
<b>Product Options with Reinforced VDE 0884-10 Rating with 10 kV Surge Capability</b>							
Si8630BT-IS	Si8630BT-AS	3	0	150	Low	5.0	WB SOIC-16
Si8630ET-IS	Si8630ET-AS	3	0	150	High	5.0	WB SOIC-16
Si8631BT-IS	Si8631BT-AS	2	1	150	Low	5.0	WB SOIC-16
Si8631ET-IS	Si8631ET-AS	2	1	150	High	5.0	WB SOIC-16
Si8635BT-IS	Si8635BT-AS	3	0	150	Low	5.0	WB SOIC-16
Si8635ET-IS	Si8635ET-AS	3	0	150	High	5.0	WB SOIC-16

Ordering Part Number (OPN)	Automotive OPNs <sup>5, 6</sup>	Number of Inputs VDD1 Side	Number of Inputs VDD2 Side	Max Data Rate (Mbps)	Default Output State	Isolation Rating (kVrms)	Package
----------------------------	---------------------------------	----------------------------	----------------------------	----------------------	----------------------	--------------------------	---------

**Note:**

1. All packages are RoHS-compliant with peak reflow temperatures of 260 °C according to the JEDEC industry standard classifications and peak solder temperatures.
2. "Si" and "SI" are used interchangeably.
3. An "R" at the end of the part number denotes tape and reel packaging option.
4. The temperature ranges is –40 to +125 °C.
5. Automotive-Grade devices (with an "-A" suffix) are identical in construction materials, topside marking, and electrical parameters to their Industrial-Grade (with an "-I" suffix) version counterparts. Automotive-Grade products are produced utilizing full automotive process flows and additional statistical process controls throughout the manufacturing flow. The Automotive-Grade part number is included on shipping labels.
6. In the top markings of each device, the Manufacturing Code represented by either "RTTTTT" or "TTTTTT" contains as its first character a letter in the range N through Z to indicate Automotive-Grade.

# Table of Contents

<b>1. Ordering Guide</b>	<b>2</b>
<b>2. System Overview</b>	<b>5</b>
2.1 Theory of Operation	5
2.2 Eye Diagram	6
<b>3. Device Operation</b>	<b>7</b>
3.1 Device Startup	9
3.2 Undervoltage Lockout	9
3.3 Layout Recommendations	9
3.3.1 Supply Bypass	9
3.3.2 Output Pin Termination	9
3.4 Fail-Safe Operating Mode	9
3.5 Typical Performance Characteristic	10
<b>4. Electrical Specifications</b>	<b>11</b>
<b>5. Pin Descriptions</b>	<b>26</b>
<b>6. Package Outline: 16-Pin Wide Body SOIC</b>	<b>27</b>
<b>7. Land Pattern: 16-Pin Wide Body SOIC</b>	<b>29</b>
<b>8. Package Outline: 16-Pin Narrow Body SOIC</b>	<b>30</b>
<b>9. Land Pattern: 16-Pin Narrow Body SOIC</b>	<b>32</b>
<b>10. Top Marking: 16-Pin Wide Body SOIC</b>	<b>33</b>
<b>11. Top Marking: 16-Pin Narrow Body SOIC</b>	<b>34</b>
<b>12. Revision History</b>	<b>35</b>

## 2. System Overview

### 2.1 Theory of Operation

The operation of an Si863x channel is analogous to that of an opto coupler, except an RF carrier is modulated instead of light. This simple architecture provides a robust isolated data path and requires no special considerations or initialization at start-up. A simplified block diagram for a single Si863x channel is shown in the figure below.



**Figure 2.1. Simplified Channel Diagram**

A channel consists of an RF Transmitter and RF Receiver separated by a semiconductor-based isolation barrier. Referring to the transmitter, input A modulates the carrier provided by an RF oscillator using on/off keying. The Receiver contains a demodulator that decodes the input state according to its RF energy content and applies the result to output B via the output driver. This RF on/off keying scheme is superior to pulse code schemes as it provides best-in-class noise immunity, low power consumption, and improved immunity to magnetic fields. See the following figure for more details.

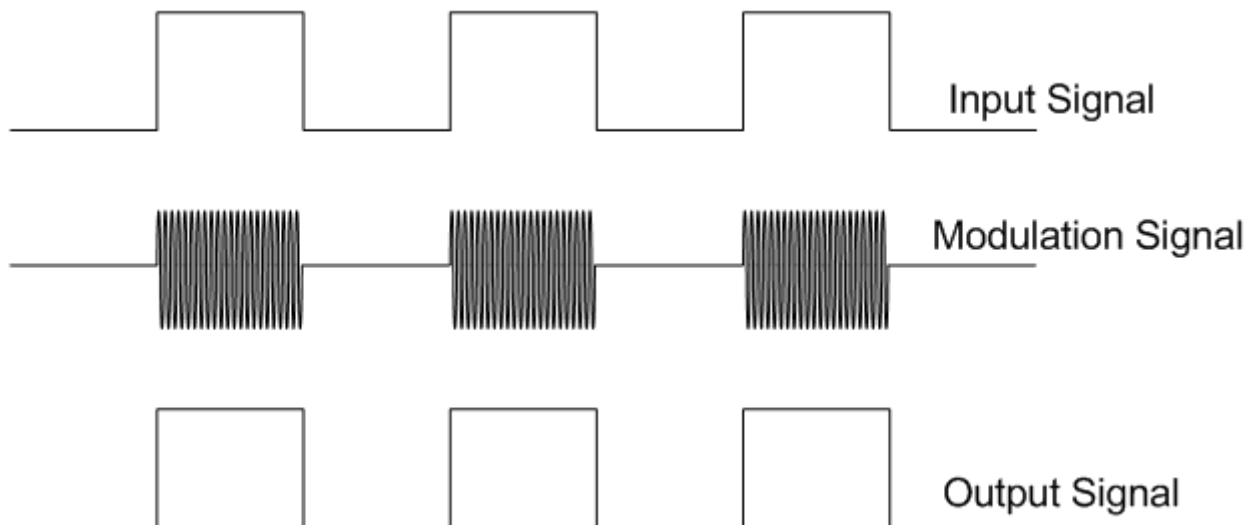

**Figure 2.2. Modulation Scheme**

## 2.2 Eye Diagram

The figure below illustrates an eye diagram taken on an Si8630. For the data source, the test used an Anritsu (MP1763C) Pulse Pattern Generator set to 1000 ns/div. The output of the generator's clock and data from an Si8630 were captured on an oscilloscope set to 1.0 ns/div. The results illustrate that data integrity was maintained even at the high data rate of 150 Mbps. The results also show that 2 ns pulse width distortion and 350 ps peak jitter were exhibited.



Figure 2.3. Eye Diagram

### 3. Device Operation

Device behavior during start-up, normal operation, and shutdown is shown in [Figure 3.1 Device Behavior during Normal Operation on page 9](#), where UVLO+ and UVLO– are the respective positive-going and negative-going thresholds. Refer to the following tables to determine outputs when power supply (VDD) is not present and for logic conditions when enable pins are used.

**Table 3.1. Si86xx Logic Operation**

V <sub>I</sub> Input <sup>1, 2</sup>	EN Input <sup>1, 2, 3, 4</sup>	VDDI State <sup>1, 5, 6</sup>	VDDO State <sup>1, 5, 6</sup>	V <sub>O</sub> Output <sup>1, 2</sup>	Comments
H	H or NC	P	P	H	Enabled, normal operation.
L	H or NC	P	P	L	
X <sup>7</sup>	L	P	P	Hi-Z <sup>8</sup>	Disabled.
NC	H or NC	P	P	L <sup>9</sup>	Output L for default low product options.
				H <sup>9</sup>	Output H for default high product options.
X <sup>7</sup>	H or NC	UP	P	L <sup>9</sup>	Upon transition of VDDI from unpowered to powered, V <sub>O</sub> returns to the same state as V <sub>I</sub> in less than 1 μs.
				H <sup>9</sup>	
X <sup>7</sup>	L	UP	P	Hi-Z <sup>8</sup>	Disabled.
X <sup>7</sup>	X <sup>7</sup>	P	UP	Undetermined	Upon transition of VDDO from unpowered to powered, V <sub>O</sub> returns to the same state as V <sub>I</sub> within 1 μs, if EN is in either the H or NC state. Upon transition of VDDO from unpowered to powered, V <sub>O</sub> returns to Hi-Z within 1 μs if EN is L.

**Note:**

- VDDI and VDDO are the input and output power supplies. V<sub>I</sub> and V<sub>O</sub> are the respective input and output terminals. EN is the enable control input located on the same output side.
- X = not applicable; H = Logic High; L = Logic Low; Hi-Z = High Impedance.
- It is recommended that the enable inputs be connected to an external logic high or low level when the Si86xx is operating in noisy environments.
- No Connect (NC) replaces EN1 on Si86x0/x5. No Connect replaces EN2 on the Si86x5. No Connects are not internally connected and can be left floating, tied to VDD, or tied to GND.
- “Powered” state (P) is defined as 2.5 V < VDD < 5.5 V.
- “Unpowered” state (UP) is defined as VDD = 0 V.
- Note that an I/O can power the die for a given side through an internal diode if its source has adequate current.
- When using the enable pin (EN) function, the output pin state is driven into a high-impedance state when the EN pin is disabled (EN = 0).
- See Section 1. [Ordering Guide](#) for details. This is the selectable fail-safe operating mode (ordering option). Some devices have default output state = H, and some have default output state = L, depending on the ordering part number (OPN). For default high devices, the data channels have 2 μA (Si86xxxA/B/C/D) or 10 μA (Si86xxxT) pull-ups on inputs/outputs. For default low devices, the data channels have 2 μA (Si86xxxA/B/C/D) or 10 μA (Si86xxxT) pull-downs on inputs/outputs.

**Table 3.2. Enable Input Truth**

Part Number	EN1 <sup>1, 2</sup>	EN2 <sup>1, 2</sup>	Operation
Si8630	—	H	Outputs B1, B2, B3 are enabled and follow input state.
	—	L	Outputs B1, B2, B3 are disabled and in high impedance state. <sup>3</sup>
Si8631	H	X	Output A3 enabled and follows the input state.
	L	X	Output A3 disabled and in high impedance state. <sup>3</sup>
	X	H	Outputs B1, B2 are enabled and follow the input state.
	X	L	Outputs B1, B2 are disabled and in high impedance state. <sup>3</sup>
Si8635	—	—	Outputs B1, B2, B3 are enabled and follow the input state.

**Note:**

1. Enable inputs EN1 and EN2 can be used for multiplexing, for clock sync, or other output control. These inputs are internally pulled-up to local VDD allowing them to be connected to an external logic level (high or low) or left floating. To minimize noise coupling, do not connect circuit traces to EN1 or EN2 if they are left floating. If EN1, EN2 are unused, it is recommended they be connected to an external logic level, especially if the Si86xx is operating in a noisy environment.
2. X = not applicable; H = Logic High; L = Logic Low.
3. When using the enable pin (EN) function, the output pin state is driven into a high-impedance state when the EN pin is disabled (EN = 0).

### 3.1 Device Startup

Outputs are held low during powerup until VDD is above the UVLO threshold for time period tSTART. Following this, the outputs follow the states of inputs.

### 3.2 Undervoltage Lockout

Undervoltage Lockout (UVLO) is provided to prevent erroneous operation during device startup and shutdown or when VDD is below its specified operating circuits range. Both Side A and Side B each have their own undervoltage lockout monitors. Each side can enter or exit UVLO independently. For example, Side A unconditionally enters UVLO when  $V_{DD1}$  falls below  $V_{DD1(UVLO-)}$  and exits UVLO when  $V_{DD1}$  rises above  $V_{DD1(UVLO+)}$ . Side B operates the same as Side A with respect to its  $V_{DD2}$  supply.

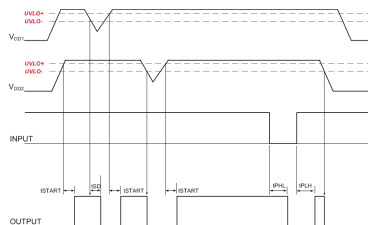

Figure 3.1. Device Behavior during Normal Operation

### 3.3 Layout Recommendations

To ensure safety in the end-user application, high-voltage circuits (i.e., circuits with  $>30 V_{AC}$ ) must be physically separated from the safety extra-low-voltage circuits (SELV is a circuit with  $<30 V_{AC}$ ) by a certain distance (creepage/clearance). If a component, such as a digital isolator, straddles this isolation barrier, it must meet those creepage/clearance requirements and also provide a sufficiently large high-voltage breakdown protection rating (commonly referred to as working voltage protection). [Table 4.6 Insulation and Safety-Related Specifications on page 22](#) and [Table 4.8 VDE 0884-10 Insulation Characteristics for Si86xx<sup>1</sup> on page 23](#) detail the working voltage and creepage/clearance capabilities of the Si86xx. These tables also detail the component standards (UL1577, IEC60747, CSA 5A), which are readily accepted by certification bodies to provide proof for end-system specifications requirements. Refer to the end-system specification (61010-1, 60950-1, 60601-1, etc.) requirements before starting any design that uses a digital isolator.

#### 3.3.1 Supply Bypass

The Si863x family requires a 0.1  $\mu F$  bypass capacitor between  $V_{DD1}$  and GND1 and  $V_{DD2}$  and GND2. The capacitor should be placed as close as possible to the package. To enhance the robustness of a design, the user may also include resistors (50–300  $\Omega$ ) in series with the inputs and outputs if the system is excessively noisy.

#### 3.3.2 Output Pin Termination

The nominal output impedance of an isolator driver channel is approximately 50  $\Omega$ ,  $\pm 40\%$ , which is a combination of the value of the on-chip series termination resistor and channel resistance of the output driver FET. When driving loads where transmission line effects will be a factor, output pins should be appropriately terminated with controlled impedance PCB traces.

### 3.4 Fail-Safe Operating Mode

Si86xx devices feature a selectable (by ordering option) mode whereby the default output state (when the input supply is unpowered) can either be a logic high or logic low when the output supply is powered. See [Table 3.1 Si86xx Logic Operation on page 7](#) and [1. Ordering Guide](#) for more information.

### 3.5 Typical Performance Characteristics

The typical performance characteristics depicted in the following diagrams are for information purposes only. Refer to 4. [Electrical Specifications](#) for actual specification limits.



Figure 3.2. Si8630/35 Typical  $V_{DD1}$  Supply Current vs. Data Rate 5, 3.3, and 2.5 V Operation



Figure 3.3. Si8630/35 Typical  $V_{DD2}$  Supply Current vs. Data Rate 5, 3.3, and 2.5 V Operation (15 pF Load)



Figure 3.4. Si8631 Typical  $V_{DD1}$  Supply Current vs. Data Rate 5, 3.3, and 2.5 V Operation

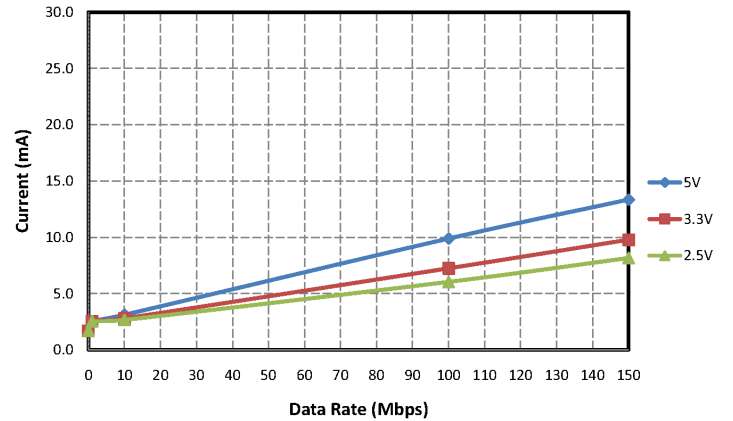

Figure 3.5. Si8631 Typical  $V_{DD2}$  Supply Current vs. Data Rate 5, 3.3, and 2.5 V Operation (15 pF Load)



Figure 3.6. Propagation Delay vs. Temperature (5.0 V Data)

## 4. Electrical Specifications

**Table 4.1. Recommended Operating Conditions**

Parameter	Symbol	Min	Typ	Max	Unit
Ambient Operating Temperature <sup>1</sup>	$T_A$	-40	25	125 <sup>1</sup>	°C
Supply Voltage	$V_{DD1}$	2.5	—	5.5	V
	$V_{DD2}$	2.5	—	5.5	V

**Note:**

1. The maximum ambient temperature is dependent on data frequency, output loading, number of operating channels, and supply voltage.

**Table 4.2. Electrical Characteristics <sup>1</sup>**

Parameter	Symbol	Test Condition	Min	Typ	Max	Unit
VDD Undervoltage Threshold	$V_{DDUV+}$	$V_{DD1}, V_{DD2}$ rising	1.95	2.24	2.375	V
VDD Undervoltage Threshold	$V_{DDUV-}$	$V_{DD1}, V_{DD2}$ falling	1.88	2.16	2.325	V
VDD Undervoltage Hysteresis	$V_{DDHYS}$		50	70	95	mV
Positive-Going Input Threshold	$V_{T+}$	All inputs rising	1.4	1.67	1.9	V
Negative-Going Input Threshold	$V_{T-}$	All inputs falling	1.0	1.23	1.4	V
Input Hysteresis	$V_{HYS}$		0.38	0.44	0.50	V
High Level Input Voltage	$V_{IH}$		2.0	—	—	V
Low Level Input Voltage	$V_{IL}$		—	—	0.8	V
High Level Output Voltage	$V_{OH}$	$I_{OH} = -4$ mA	$V_{DD1}, V_{DD2} - 0.4$	4.8	—	V
Low Level Output Voltage	$V_{OL}$	$I_{OL} = 4$ mA	—	0.2	0.4	V
Input Leakage Current	$I_L$		—	—	±10	μA
Si863xxA/B/C/D			—	—	±15	
Output Impedance <sup>2</sup>	$Z_O$		—	50	—	Ω
Enable Input Current	$I_{ENH}, I_{ENL}$	$V_{ENx} = V_{IH}$ or $V_{IL}$	—	2.0	—	μA
Si863xxA/B/C/D			—	10.0	—	
Si863xxT						

**DC Supply Current (All Inputs 0 V or at Supply)**

Si8630Bx, Ex, Si8635Bx						
$V_{DD1}$		$V_I = 0(Bx), 1(Ex)$	—	0.9	1.6	mA
$V_{DD2}$		$V_I = 0(Bx), 1(Ex)$	—	1.9	3.0	
$V_{DD1}$		$V_I = 1(Bx), 0(Ex)$	—	4.6	7.4	
$V_{DD2}$		$V_I = 1(Bx), 0(Ex)$	—	1.9	3.0	

Parameter	Symbol	Test Condition	Min	Typ	Max	Unit
<b>Si8631Bx, Ex</b>						
$V_{DD1}$		$V_I = 0(\text{Bx}), 1(\text{Ex})$	—	1.3	2.1	mA
$V_{DD2}$		$V_I = 0(\text{Bx}), 1(\text{Ex})$	—	1.7	2.7	
$V_{DD1}$		$V_I = 1(\text{Bx}), 0(\text{Ex})$	—	3.9	5.9	
$V_{DD2}$		$V_I = 1(\text{Bx}), 0(\text{Ex})$	—	3.0	4.5	
<b>1 Mbps Supply Current (All Inputs = 500 kHz Square Wave, CI = 15 pF on All Outputs)</b>						
<b>Si8630Bx, Ex, Si8635Bx</b>						
$V_{DD1}$			—	2.8	3.9	mA
$V_{DD2}$			—	2.2	3.1	
<b>Si8631Bx, Ex</b>						
$V_{DD1}$			—	2.7	3.8	mA
$V_{DD2}$			—	2.6	3.6	
<b>10 Mbps Supply Current (All Inputs = 5 MHz Square Wave, CI = 15 pF on All Outputs)</b>						
<b>Si8630xA/B/C/D, Si8635xA/B/C/D</b>						
$V_{DD1}$			—	2.8	3.9	mA
$V_{DD2}$			—	3.1	4.3	
<b>Si8630xT, Si8635xT</b>						
$V_{DD1}$			—	2.8	4.9	mA
$V_{DD2}$			—	3.1	4.3	
<b>Si8631Bx, Ex</b>						
$V_{DD1}$			—	3.0	4.2	mA
$V_{DD2}$			—	3.1	4.4	
<b>100 Mbps Supply Current (All Inputs = 50 MHz Square Wave, CI = 15 pF on All Outputs)</b>						
<b>Si8630xA/B/C/D, Si8635xA/B/C/D</b>						
$V_{DD1}$			—	2.8	3.9	mA
$V_{DD2}$			—	13.2	17.8	
<b>Si8630xT, Si8635xT</b>						
$V_{DD1}$			—	2.8	4.9	mA
$V_{DD2}$			—	13.2	17.8	
<b>Si8631Bx, Ex</b>						
$V_{DD1}$			—	6.6	8.8	mA
$V_{DD2}$			—	9.9	13.4	
<b>Timing Characteristics</b>						
<b>Si863xBx, Ex</b>						
Maximum Data Rate			0	—	150	Mbps

Parameter	Symbol	Test Condition	Min	Typ	Max	Unit
Minimum Pulse Width			—	—	5.0	ns
Propagation Delay	$t_{PHL}$ , $t_{PLH}$	See Figure 4.2 Propagation Delay Timing on page 14	5.0	8.0	13	ns
Pulse Width Distortion $ t_{PLH} - t_{PHL} $	PWD	See Figure 4.2 Propagation Delay Timing on page 14	—	0.2	4.5	ns
Propagation Delay Skew <sup>3</sup>	$t_{PSK(P-P)}$		—	2.0	4.5	ns
Channel-Channel Skew	$t_{PSK}$		—	0.4	2.5	ns
<b>All Models</b>						
Output Rise Time	$t_r$	$C_L = 15 \text{ pF}$ See Figure 4.2 Propagation Delay Timing on page 14	—	2.5	4.0	ns
Output Fall Time	$t_f$	$C_L = 15 \text{ pF}$ See Figure 4.2 Propagation Delay Timing on page 14	—	2.5	4.0	ns
Peak Eye Diagram Jitter	$t_{JIT(PK)}$	See Figure 2.3 Eye Diagram on page 6	—	350	—	ps
Common Mode Transient Immunity Si86xxxB/C/D Si86xxxT	CMTI	$V_I = V_{DD}$ or 0 V $V_{CM} = 1500 \text{ V}$ See Figure 4.3 Common-Mode Transient Immunity Test Circuit on page 14	35 60	50 100	— —	kV/ $\mu$ s
Enable to Data Valid	$t_{en1}$	See Figure 4.1 ENABLE Timing Diagram on page 14	—	6.0	11	ns
Enable to Data Tri-State	$t_{en2}$	See Figure 4.1 ENABLE Timing Diagram on page 14	—	8.0	12	ns
Input power loss to valid default output	$t_{SD}$	See Figure 3.1 Device Behavior during Normal Operation on page 9	—	8.0	12	ns
Start-up Time <sup>4</sup>	$t_{SU}$		—	15	40	$\mu$ s
<b>Note:</b>						
1. $V_{DD1} = 5 \text{ V} \pm 10\%$ ; $V_{DD2} = 5 \text{ V} \pm 10\%$ , $T_A = -40$ to $125 \text{ }^\circ\text{C}$						
2. The nominal output impedance of an isolator driver channel is approximately $50 \text{ } \Omega$ , $\pm 40\%$ , which is a combination of the value of the on-chip series termination resistor and channel resistance of the output driver FET. When driving loads where transmission line effects will be a factor, output pins should be appropriately terminated with controlled-impedance PCB traces.						
3. $t_{PSK(P-P)}$ is the magnitude of the difference in propagation delay times measured between different units operating at the same supply voltages, load, and ambient temperature.						
4. Start-up time is the time period from the application of power to the appearance of valid data at the output.						

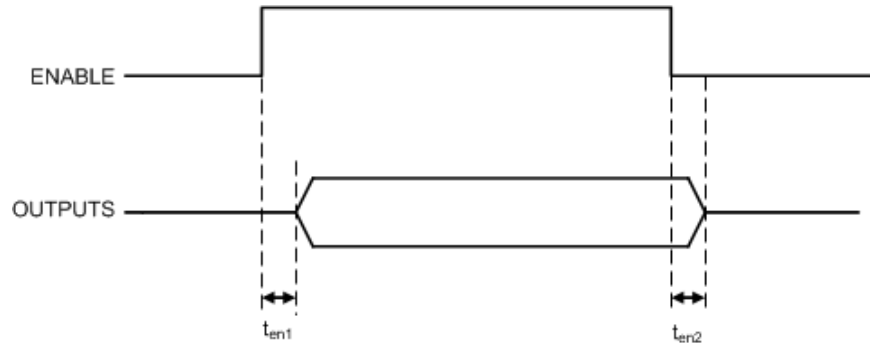

Figure 4.1. ENABLE Timing Diagram



Figure 4.2. Propagation Delay Timing

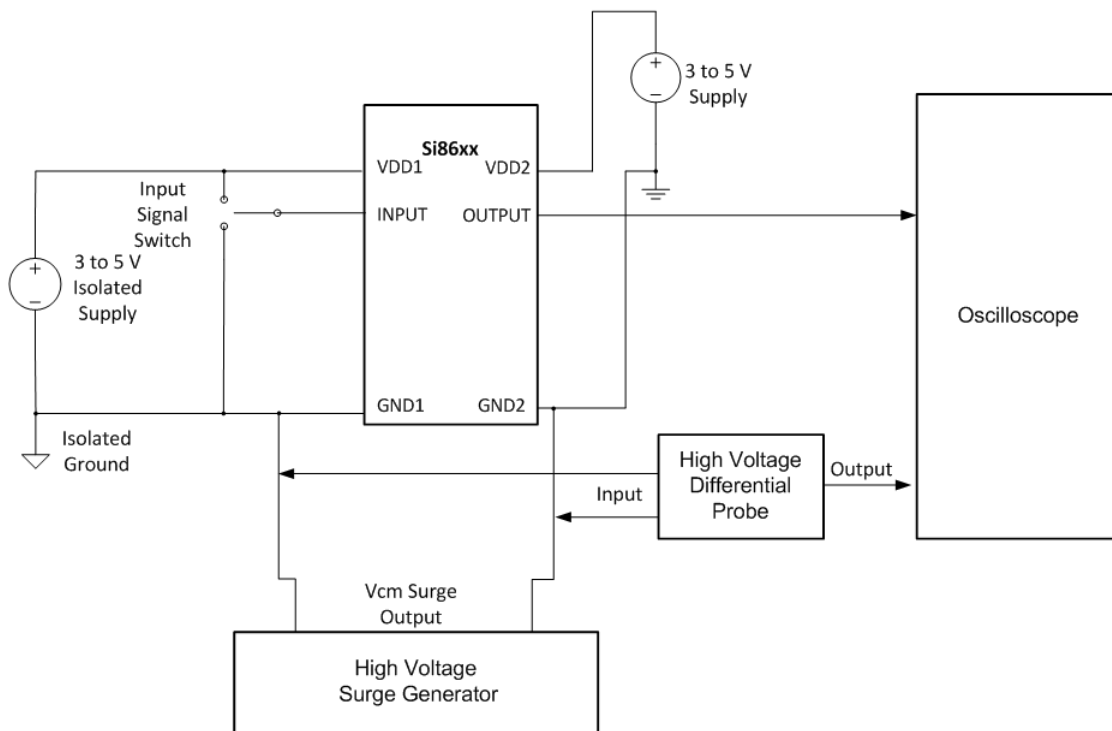

Figure 4.3. Common-Mode Transient Immunity Test Circuit

Table 4.3. Electrical Characteristics <sup>1</sup>

Parameter	Symbol	Test Condition	Min	Typ	Max	Unit
VDD Undervoltage Threshold	VDD <sub>UV+</sub>	V <sub>DD1</sub> , V <sub>DD2</sub> rising	1.95	2.24	2.375	V
VDD Undervoltage Threshold	VDD <sub>UV-</sub>	V <sub>DD1</sub> , V <sub>DD2</sub> falling	1.88	2.16	2.325	V
VDD Undervoltage Hysteresis	VDD <sub>HYS</sub>		50	70	95	mV
Positive-Going Input Threshold	VT+	All inputs rising	1.4	1.67	1.9	V
Negative-Going Input Threshold	VT-	All inputs falling	1.0	1.23	1.4	V
Input Hysteresis	V <sub>HYS</sub>		0.38	0.44	0.50	V
High Level Input Voltage	V <sub>IH</sub>		2.0	—	—	V
Low Level Input Voltage	V <sub>IL</sub>		—	—	0.8	V
High Level Output Voltage	V <sub>OH</sub>	I <sub>oh</sub> = -4 mA	V <sub>DD1</sub> , V <sub>DD2</sub> - 0.4	3.1	—	V
Low Level Output Voltage	V <sub>OL</sub>	I <sub>ol</sub> = 4 mA	—	0.2	0.4	V
Input Leakage Current						
Si863xxA/B/C/D	I <sub>L</sub>		—	—	±10	μA
Si863xxT			—	—	±15	
Output Impedance <sup>2</sup>	Z <sub>O</sub>		—	50	—	Ω
Enable Input Current						
Si863xxA/B/C/D	I <sub>ENH</sub> , I <sub>ENL</sub>	V <sub>ENx</sub> = V <sub>IH</sub> or V <sub>IL</sub>	—	2.0	—	μA
Si863xxT			—	10.0	—	
<b>DC Supply Current (All Inputs 0 V or at Supply)</b>						
<b>Si8630Bx, Ex, Si8635Bx</b>						
V <sub>DD1</sub>		V <sub>I</sub> = 0(Bx), 1(Ex)	—	0.9	1.6	mA
V <sub>DD2</sub>		V <sub>I</sub> = 0(Bx), 1(Ex)	—	1.9	3.0	
V <sub>DD1</sub>		V <sub>I</sub> = 1(Bx), 0(Ex)	—	4.6	7.4	
V <sub>DD2</sub>		V <sub>I</sub> = 1(Bx), 0(Ex)	—	1.9	3.0	
<b>Si8631Bx, Ex</b>						
V <sub>DD1</sub>		V <sub>I</sub> = 0(Bx), 1(Ex)	—	1.3	2.1	mA
V <sub>DD2</sub>		V <sub>I</sub> = 0(Bx), 1(Ex)	—	1.7	2.7	
V <sub>DD1</sub>		V <sub>I</sub> = 1(Bx), 0(Ex)	—	3.9	5.9	
V <sub>DD2</sub>		V <sub>I</sub> = 1(Bx), 0(Ex)	—	3.0	4.5	
<b>1 Mbps Supply Current (All Inputs = 500 kHz Square Wave, CI = 15 pF on All Outputs)</b>						
<b>Si8630Bx, Ex, Si8635Bx</b>						
V <sub>DD1</sub>			—	2.8	3.9	mA
V <sub>DD2</sub>			—	2.2	3.1	

Parameter	Symbol	Test Condition	Min	Typ	Max	Unit
<b>Si8631Bx, Ex</b>						
$V_{DD1}$			—	2.7	3.8	mA
$V_{DD2}$			—	2.6	3.6	
<b>10 Mbps Supply Current (All Inputs = 5 MHz Square Wave, CI = 15 pF on All Outputs)</b>						
<b>Si8630xA/B/C/D, Si8635xA/B/C/D</b>						
$V_{DD1}$			—	2.8	3.9	mA
$V_{DD2}$			—	2.6	3.6	
<b>Si8630xT, Si8635xT</b>						
$V_{DD1}$			—	2.8	4.9	mA
$V_{DD2}$			—	2.6	3.6	
<b>Si8631Bx, Ex</b>						
$V_{DD1}$			—	2.8	4.0	mA
$V_{DD2}$			—	2.6	3.9	
<b>100 Mbps Supply Current (All Inputs = 50 MHz Square Wave, CI = 15 pF on All Outputs)</b>						
<b>Si8630xA/B/C/D, Si8635xA/B/C/D</b>						
$V_{DD1}$			—	2.8	3.9	mA
$V_{DD2}$			—	9.3	12.5	
<b>Si8630xT, Si8635xT</b>						
$V_{DD1}$			—	2.8	4.9	mA
$V_{DD2}$			—	9.3	12.5	
<b>Si8631Bx, Ex</b>						
$V_{DD1}$			—	5.2	7.0	mA
$V_{DD2}$			—	7.3	9.8	
<b>Timing Characteristics</b>						
<b>Si863xBx, Ex</b>						
Maximum Data Rate			0	—	150	Mbps
Minimum Pulse Width			—	—	5.0	ns
Propagation Delay	$t_{PHL}$ , $t_{PLH}$	See Figure 4.2 Propagation Delay Timing on page 14	5.0	8.0	13	ns
Pulse Width Distortion $ t_{PLH} - t_{PHL} $	PWD	See Figure 4.2 Propagation Delay Timing on page 14	—	0.2	4.5	ns
Propagation Delay Skew <sup>3</sup>	$t_{PSK(P-P)}$		—	2.0	4.5	ns
Channel-Channel Skew	$t_{PSK}$		—	0.4	2.5	ns
<b>All Models</b>						

Parameter	Symbol	Test Condition	Min	Typ	Max	Unit
Output Rise Time	$t_r$	$C_L = 15 \text{ pF}$ See Figure 4.2 Propagation Delay Timing on page 14	—	2.5	4.0	ns
Output Fall Time	$t_f$	$C_L = 15 \text{ pF}$ See Figure 4.2 Propagation Delay Timing on page 14	—	2.5	4.0	ns
Peak Eye Diagram Jitter	$t_{\text{JIT(PK)}}$	See Figure 2.3 Eye Diagram on page 6	—	350	—	ps
Common Mode Transient Immunity Si86xxxB/C/D Si86xxxT	CMTI	$V_I = V_{\text{DD}}$ or 0 V $V_{\text{CM}} = 1500 \text{ V}$ See Figure 4.3 Common-Mode Transient Immunity Test Circuit on page 14	35 60	50 100	— —	kV/ $\mu\text{s}$
Enable to Data Valid	$t_{\text{en1}}$	See Figure 4.1 ENABLE Timing Diagram on page 14	—	6.0	11	ns
Enable to Data Tri-State	$t_{\text{en2}}$	See Figure 4.1 ENABLE Timing Diagram on page 14	—	8.0	12	ns
Input power loss to valid default output	$t_{\text{SD}}$	See Figure 3.1 Device Behavior during Normal Operation on page 9	—	8.0	12	ns
Start-up Time <sup>4</sup>	$t_{\text{SU}}$		—	15	40	$\mu\text{s}$

**Note:**

- $V_{\text{DD1}} = 3.3 \text{ V} \pm 10\%$ ;  $V_{\text{DD2}} = 3.3 \text{ V} \pm 10\%$ ,  $T_A = -40$  to  $125 \text{ }^\circ\text{C}$
- The nominal output impedance of an isolator driver channel is approximately  $50 \text{ } \Omega$ ,  $\pm 40\%$ , which is a combination of the value of the on-chip series termination resistor and channel resistance of the output driver FET. When driving loads where transmission line effects will be a factor, output pins should be appropriately terminated with controlled-impedance PCB traces.
- $t_{\text{PSK(P-P)}}$  is the magnitude of the difference in propagation delay times measured between different units operating at the same supply voltages, load, and ambient temperature.
- Start-up time is the time period from the application of power to the appearance of valid data at the output.

**Table 4.4. Electrical Characteristics <sup>1</sup>**

Parameter	Symbol	Test Condition	Min	Typ	Max	Unit
VDD Undervoltage Threshold	VDD <sub>UV+</sub>	V <sub>DD1</sub> , V <sub>DD2</sub> rising	1.95	2.24	2.375	V
VDD Undervoltage Threshold	VDD <sub>UV-</sub>	V <sub>DD1</sub> , V <sub>DD2</sub> falling	1.88	2.16	2.325	V
VDD Undervoltage Hysteresis	VDD <sub>HYS</sub>		50	70	95	mV
Positive-Going Input Threshold	VT <sub>+</sub>	All inputs rising	1.4	1.67	1.9	V
Negative-Going Input Threshold	VT <sub>-</sub>	All inputs falling	1.0	1.23	1.4	V
Input Hysteresis	V <sub>HYS</sub>		0.38	0.44	0.50	V
High Level Input Voltage	V <sub>IH</sub>		2.0	—	—	V
Low Level Input Voltage	V <sub>IL</sub>		—	—	0.8	V
High Level Output Voltage	V <sub>OH</sub>	I <sub>oh</sub> = -4 mA	V <sub>DD1</sub> , V <sub>DD2</sub> - 0.4	2.3	—	V
Low Level Output Voltage	V <sub>OL</sub>	I <sub>ol</sub> = 4 mA	—	0.2	0.4	V
Input Leakage Current						
Si863xxA/B/C/D	I <sub>L</sub>		—	—	±10	μA
Si863xxT			—	—	±15	
Output Impedance <sup>2</sup>	Z <sub>O</sub>		—	50	—	Ω
Enable Input Current						
Si863xxA/B/C/D	I <sub>ENH</sub> , I <sub>ENL</sub>	V <sub>ENx</sub> = V <sub>IH</sub> or V <sub>IL</sub>	—	2.0	—	μA
Si863xxT			—	10.0	—	
<b>DC Supply Current (All Inputs 0 V or at Supply)</b>						
<b>Si8630Bx, Ex, Si8635Bx</b>						
V <sub>DD1</sub>		V <sub>I</sub> = 0(Bx), 1(Ex)	—	0.9	1.6	mA
V <sub>DD2</sub>		V <sub>I</sub> = 0(Bx), 1(Ex)	—	1.9	3.0	
V <sub>DD1</sub>		V <sub>I</sub> = 1(Bx), 0(Ex)	—	4.6	7.4	
V <sub>DD2</sub>		V <sub>I</sub> = 1(Bx), 0(Ex)	—	1.9	3.0	
<b>Si8631Bx, Ex</b>						
V <sub>DD1</sub>		V <sub>I</sub> = 0(Bx), 1(Ex)	—	1.3	2.1	mA
V <sub>DD2</sub>		V <sub>I</sub> = 0(Bx), 1(Ex)	—	1.7	2.7	
V <sub>DD1</sub>		V <sub>I</sub> = 1(Bx), 0(Ex)	—	3.9	5.9	
V <sub>DD2</sub>		V <sub>I</sub> = 1(Bx), 0(Ex)	—	3.0	4.5	
<b>1 Mbps Supply Current (All Inputs = 500 kHz Square Wave, CI = 15 pF on All Outputs)</b>						
<b>Si8630Bx, Ex, Si8635Bx</b>						
V <sub>DD1</sub>			—	2.8	3.9	mA
V <sub>DD2</sub>			—	2.2	3.1	

Parameter	Symbol	Test Condition	Min	Typ	Max	Unit
<b>Si8631Bx, Ex</b>						
$V_{DD1}$			—	2.7	3.8	mA
$V_{DD2}$			—	2.6	3.6	
<b>10 Mbps Supply Current (All Inputs = 5 MHz Square Wave, CI = 15 pF on All Outputs)</b>						
<b>Si8630xA/B/C/D, Si8635xA/B/C/D</b>						
$V_{DD1}$			—	2.8	3.9	mA
$V_{DD2}$			—	2.4	3.3	
<b>Si8630xT, Si8635xT</b>						
$V_{DD1}$			—	2.8	4.9	mA
$V_{DD2}$			—	2.4	3.3	
<b>Si8631Bx, Ex</b>						
$V_{DD1}$			—	2.8	3.9	mA
$V_{DD2}$			—	2.7	3.7	
<b>100 Mbps Supply Current (All Inputs = 50 MHz Square Wave, CI = 15 pF on All Outputs)</b>						
<b>Si8630xA/B/C/D, Si8635xA/B/C/D</b>						
$V_{DD1}$			—	2.8	3.9	mA
$V_{DD2}$			—	7.5	10.1	
<b>Si8630xT, Si8635xT</b>						
$V_{DD1}$			—	2.8	4.9	mA
$V_{DD2}$			—	7.5	10.1	
<b>Si8631Bx, Ex</b>						
$V_{DD1}$			—	4.5	6.1	mA
$V_{DD2}$			—	6.1	8.2	
<b>Timing Characteristics</b>						
<b>Si863xBx, Ex</b>						
Maximum Data Rate			0	—	150	Mbps
Minimum Pulse Width			—	—	5.0	ns
Propagation Delay	$t_{PHL}$ , $t_{PLH}$	See Figure 4.2 Propagation Delay Timing on page 14	5.0	8.0	14	ns
Pulse Width Distortion $ t_{PLH} - t_{PHL} $	PWD	See Figure 4.2 Propagation Delay Timing on page 14	—	0.2	5.0	ns
Propagation Delay Skew <sup>3</sup>	$t_{PSK(P-P)}$		—	2.0	5.0	ns
Channel-Channel Skew	$t_{PSK}$		—	0.4	2.5	ns
<b>All Models</b>						

Parameter	Symbol	Test Condition	Min	Typ	Max	Unit
Output Rise Time	$t_r$	$C_L = 15 \text{ pF}$ See Figure 4.2 Propagation Delay Timing on page 14	—	2.5	4.0	ns
Output Fall Time	$t_f$	$C_L = 15 \text{ pF}$ See Figure 4.2 Propagation Delay Timing on page 14	—	2.5	4.0	ns
Peak Eye Diagram Jitter	$t_{\text{JIT(PK)}}$	See Figure 2.3 Eye Diagram on page 6	—	350	—	ps
Common Mode Transient Immunity Si86xxxB/C/D Si86xxxT	CMTI	$V_I = V_{\text{DD}}$ or 0 V $V_{\text{CM}} = 1500 \text{ V}$ See Figure 4.3 Common-Mode Transient Immunity Test Circuit on page 14	35 60	50 100	— —	kV/ $\mu\text{s}$
Enable to Data Valid	$t_{\text{en1}}$	See Figure 4.1 ENABLE Timing Diagram on page 14	—	6.0	11	ns
Enable to Data Tri-State	$t_{\text{en2}}$	See Figure 4.1 ENABLE Timing Diagram on page 14	—	8.0	12	ns
Input power loss to valid default output	$t_{\text{SD}}$	See Figure 3.1 Device Behavior during Normal Operation on page 9	—	8.0	12	ns
Start-up Time <sup>4</sup>	$t_{\text{SU}}$		—	15	40	$\mu\text{s}$

**Note:**

- $V_{\text{DD1}} = 2.5 \text{ V} \pm 5\%$ ;  $V_{\text{DD2}} = 2.5 \text{ V} \pm 5\%$ ,  $T_A = -40$  to  $125 \text{ }^\circ\text{C}$
- The nominal output impedance of an isolator driver channel is approximately  $50 \text{ } \Omega$ ,  $\pm 40\%$ , which is a combination of the value of the on-chip series termination resistor and channel resistance of the output driver FET. When driving loads where transmission line effects will be a factor, output pins should be appropriately terminated with controlled-impedance PCB traces.
- $t_{\text{PSK(P-P)}}$  is the magnitude of the difference in propagation delay times measured between different units operating at the same supply voltages, load, and ambient temperature.
- Start-up time is the time period from the application of power to the appearance of valid data at the output.

**Table 4.5. Regulatory Information** 1, 2, 3, 4

<b>For All Product Options Except Si863xxT</b>
<b>CSA</b>
The Si863x is certified under CSA Component Acceptance Notice 5A. For more details, see File 232873.
61010-1: Up to 600 V <sub>RMS</sub> reinforced insulation working voltage; up to 600 V <sub>RMS</sub> basic insulation working voltage.
60950-1: Up to 600 V <sub>RMS</sub> reinforced insulation working voltage; up to 1000 V <sub>RMS</sub> basic insulation working voltage.
60601-1: Up to 125 V <sub>RMS</sub> reinforced insulation working voltage; up to 380 V <sub>RMS</sub> basic insulation working voltage.
<b>VDE</b>
The Si863x is certified according to IEC 60747-5-5. For more details, see File 5006301-4880-0001.
60747-5-5: Up to 1200 V <sub>peak</sub> for basic insulation working voltage.
60950-1: Up to 600 V <sub>RMS</sub> reinforced insulation working voltage; up to 1000 V <sub>RMS</sub> basic insulation working voltage.
<b>UL</b>
The Si863x is certified under UL1577 component recognition program. For more details, see File E257455.
Rated up to 5000 V <sub>RMS</sub> isolation voltage for basic protection.
<b>CQC</b>
The Si863x is certified under GB4943.1-2011. For more details, see certificates CQC13001096110 and CQC13001096239.
Rated up to 600 V <sub>RMS</sub> reinforced insulation working voltage; up to 1000 V <sub>RMS</sub> basic insulation working voltage.
<b>For All Si863xxT Product Options</b>
<b>CSA</b>
Certified under CSA Component Acceptance Notice 5A. For more details, see File 232873.
60950-1: Up to 600 V <sub>RMS</sub> reinforced insulation working voltage; up to 1000 V <sub>RMS</sub> basic insulation working voltage.
<b>VDE</b>
Certified according to VDE 0884-10.
<b>UL</b>
Certified under UL1577 component recognition program. For more details, see File E257455.
Rated up to 5000 V <sub>RMS</sub> isolation voltage for basic protection.
<b>CQC</b>
Certified under GB4943.1-2011
Rated up to 600 V <sub>RMS</sub> reinforced insulation working voltage; up to 1000 V <sub>RMS</sub> basic insulation working voltage.
<b>Note:</b>
<ol style="list-style-type: none"> <li>1. Regulatory Certifications apply to 2.5 kV<sub>RMS</sub> rated devices, which are production tested to 3.0 kV<sub>RMS</sub> for 1 s.</li> <li>2. Regulatory Certifications apply to 3.75 kV<sub>RMS</sub> rated devices, which are production tested to 4.5 kV<sub>RMS</sub> for 1 s.</li> <li>3. Regulatory Certifications apply to 5.0 kV<sub>RMS</sub> rated devices, which are production tested to 6.0 kV<sub>RMS</sub> for 1 s.</li> <li>4. For more information, see <a href="#">1. Ordering Guide</a>.</li> </ol>

**Table 4.6. Insulation and Safety-Related Specifications**

Parameter	Symbol	Test Condition	Value		Unit
			WB SOIC-16	NB SOIC-16	
Nominal Air Gap (Clearance) <sup>1</sup>	L(IO1)		8.0	4.9	mm
Nominal External Tracking <sup>1</sup>	L(IO2)		8.0	4.01	mm
Minimum Internal Gap (Internal Clearance)			0.014	0.014	mm
Tracking Resistance (Proof Tracking Index)	PTI	IEC60112	600	600	V <sub>RMS</sub>
Erosion Depth	ED		0.019	0.019	mm
Resistance (Input-Output) <sup>2</sup>	R <sub>IO</sub>		10 <sup>12</sup>	10 <sup>12</sup>	Ω
Capacitance (Input-Output) <sup>2</sup>	C <sub>IO</sub>	f = 1 MHz	2.0	2.0	pF
Input Capacitance <sup>3</sup>	C <sub>I</sub>		4.0	4.0	pF
<b>Note:</b>					
1. The values in this table correspond to the nominal creepage and clearance values. VDE certifies the clearance and creepage limits as 4.7 mm minimum for the NB SOIC-16 package and 8.5 mm minimum for the WB SOIC-16 package. UL does not impose a clearance and creepage minimum for component-level certifications. CSA certifies the clearance and creepage limits as 3.9 mm minimum for the NB SOIC-16 and 7.6 mm minimum for the WB SOIC-16 package.					
2. To determine resistance and capacitance, the Si86xx is converted into a 2-terminal device. Pins 1–8 are shorted together to form the first terminal and pins 9–16 are shorted together to form the second terminal. The parameters are then measured between these two terminals.					
3. Measured from input pin to ground.					

**Table 4.7. IEC 60664-1 Ratings**

Parameter	Test Conditions	Specification	
		WB SOIC-16	NB SOIC-16
Basic Isolation Group	Material Group	I	I
Installation Classification	Rated Mains Voltages ≤ 150 V <sub>RMS</sub>	I-IV	I-IV
	Rated Mains Voltages ≤ 300 V <sub>RMS</sub>	I-IV	I-III
	Rated Mains Voltages ≤ 400 V <sub>RMS</sub>	I-III	I-II
	Rated Mains Voltages ≤ 600 V <sub>RMS</sub>	I-III	I-II

**Table 4.8. VDE 0884-10 Insulation Characteristics for Si86xx<sup>1</sup>**

Parameter	Symbol	Test Condition	Characteristic			Unit
			WB SOIC-16	NB SOIC-16	QSOP-16	
Maximum Working Insulation Voltage	V <sub>IORM</sub>		1200	630	630	V <sub>peak</sub>
Input to Output Test Voltage	V <sub>PR</sub>	Method b1 (V <sub>IORM</sub> × 1.875 = V <sub>PR</sub> , 100% Production Test, t <sub>m</sub> = 1 sec, Partial Discharge < 5 pC)	2250	1182	1182	V <sub>peak</sub>
Transient Overvoltage (Si86xxxA/B/C/D)	V <sub>IOTM</sub>	t = 60 sec	6000	6000	6000	V <sub>peak</sub>
Transient Overvoltage (Si86xxxT)			8000	8000	8000	
Surge Voltage	V <sub>IOSM</sub>	Tested per IEC 60065 with surge voltage of 1.2 μs/50 μs  Si864xxT tested with magnitude 6250 V × 1.6 = 10 kV  Si864xxB/C/D tested with 4000 V	6250	—	—	V <sub>peak</sub>
			3077	3077	3077	
Pollution Degree (DIN VDE 0110, Table 1)			2	2	2	
Insulation Resistance at T <sub>S</sub> , V <sub>IO</sub> = 500 V	R <sub>S</sub>		>10 <sup>9</sup>	>10 <sup>9</sup>	>10 <sup>9</sup>	Ω

**Note:**

1. Maintenance of the safety data is ensured by protective circuits. The Si86xx provides a climate classification of 40/125/21.

**Table 4.9. IEC Safety Limiting Values<sup>1</sup>**

Parameter	Symbol	Test Condition	Max		Unit
			WB SOIC-16	NB SOIC-16	
Case Temperature	T <sub>S</sub>		150	150	°C
Safety Input, Output, or Supply Current	I <sub>S</sub>	θ <sub>JA</sub> = 100 °C/W (WB SOIC-16)  105 °C/W (NB SOIC-16)  V <sub>I</sub> = 5.5 V, T <sub>J</sub> = 150 °C, T <sub>A</sub> = 25 °C	220	210	mA
Device Power Dissipation <sup>2</sup>	P <sub>D</sub>		275	275	mW

**Note:**

1. Maximum value allowed in the event of a failure; also see the thermal derating curve in [Figure 4.4 \(WB SOIC-16\) Thermal Derating Curve, Dependence of Safety Limiting Values with Case Temperature per DIN EN 60747-5-5/VDE 0884-10, as Applies on page 24](#) and [Figure 4.5 \(NB SOIC-16\) Thermal Derating Curve, Dependence of Safety Limiting Values with Case Temperature per DIN EN 60747-5-5/VDE 0884-10, as Applies on page 24](#).

2. The Si86xx is tested with VDD1 = VDD2 = 5.5 V; T<sub>J</sub> = 150 °C; C<sub>L</sub> = 15 pF, input a 150 Mbps 50% duty cycle square wave.

**Table 4.10. Thermal Characteristics**

Parameter	Symbol	WB SOIC-16	NB SOIC-16	Unit
IC Junction-to-Air Thermal Resistance	$\theta_{JA}$	100	105	$^{\circ}\text{C}/\text{W}$

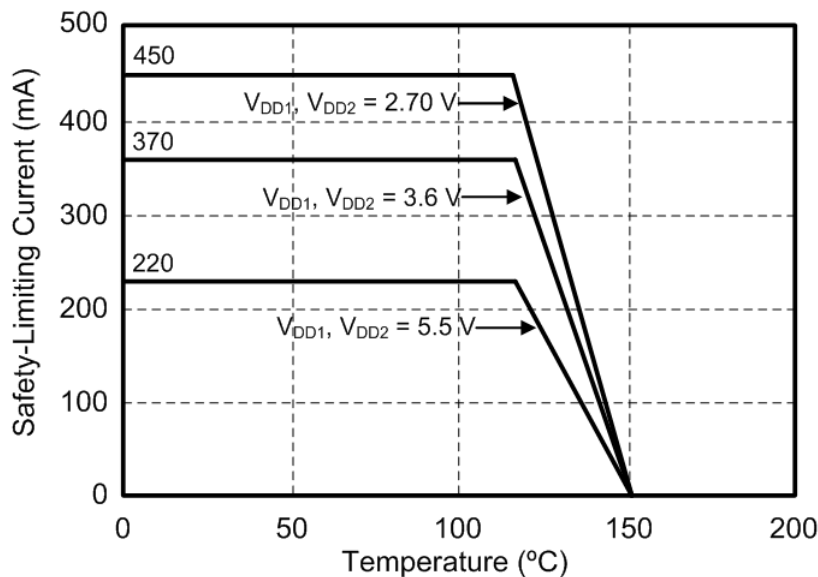

**Figure 4.4. (WB SOIC-16) Thermal Derating Curve, Dependence of Safety Limiting Values with Case Temperature per DIN EN 60747-5-5/VDE 0884-10, as Applies**

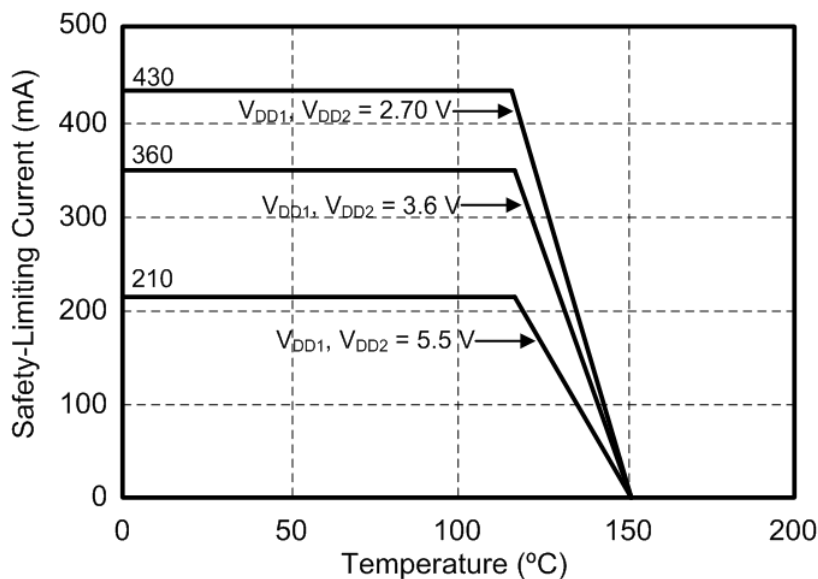

**Figure 4.5. (NB SOIC-16) Thermal Derating Curve, Dependence of Safety Limiting Values with Case Temperature per DIN EN 60747-5-5/VDE 0884-10, as Applies**

**Table 4.11. Absolute Maximum Ratings <sup>1</sup>**

Parameter	Symbol	Min	Max	Unit
Storage Temperature <sup>2</sup>	T <sub>STG</sub>	-65	150	°C
Operating Temperature	T <sub>A</sub>	-40	125	°C
Junction Temperature	T <sub>J</sub>	—	150	°C
Supply Voltage	V <sub>DD1</sub> , V <sub>DD2</sub>	-0.5	7.0	V
Input Voltage	V <sub>I</sub>	-0.5	V <sub>DD</sub> + 0.5	V
Output Voltage	V <sub>O</sub>	-0.5	V <sub>DD</sub> + 0.5	V
Output Current Drive Channel	I <sub>O</sub>	—	10	mA
Lead Solder Temperature (10 s)		—	260	°C
Maximum Isolation (Input to Output) (1 sec) NB SOIC-16		—	4500	V <sub>RMS</sub>
Maximum Isolation (Input to Output) (1 sec) WB SOIC-16		—	6500	V <sub>RMS</sub>

**Note:**

1. Permanent device damage may occur if the absolute maximum ratings are exceeded. Functional operation should be restricted to conditions as specified in the operational sections of this data sheet. Exposure to absolute maximum ratings for extended periods may degrade performance.
2. VDE certifies storage temperature from -40 to 150 °C.

## 5. Pin Descriptions



Name	SOIC-16 Pin#	Type	Description
V <sub>DD1</sub>	1	Supply	Side 1 power supply.
GND1	2 <sup>1</sup>	Ground	Side 1 ground.
A1	3	Digital Input	Side 1 digital input.
A2	4	Digital Input	Side 1 digital input.
A3	5	Digital I/O	Side 1 digital input or output.
NC	6	NA	No Connect.
EN1/NC <sup>2</sup>	7	Digital Input	Side 1 active high enable. NC on Si8630/35
GND1	8 <sup>1</sup>	Ground	Side 1 ground.
GND2	9 <sup>1</sup>	Ground	Side 2 ground.
EN2/NC <sup>2</sup>	10	Digital Input	Side 2 active high enable. NC on Si8635.
NC	11	NA	No Connect.
B3	12	Digital I/O	Side 2 digital input or output.
B2	13	Digital Output	Side 2 digital output.
B1	14	Digital Output	Side 2 digital output.
GND2	15 <sup>1</sup>	Ground	Side 2 ground.
V <sub>DD2</sub>	16	Supply	Side 2 power supply.

### Note:

- For narrow-body devices, Pin 2 and Pin 8 GND must be externally connected to respective ground. Pin 9 and Pin 15 must also be connected to external ground.
- No Connect. These pins are not internally connected. They can be left floating, tied to VDD or tied to GND.

## 6. Package Outline: 16-Pin Wide Body SOIC

The figure below illustrates the package details for the Triple-Channel Digital Isolator. The table lists the values for the dimensions shown in the illustration.



**Figure 6.1. 16-Pin Wide Body SOIC**

**Table 6.1. 16-Pin Wide Body SOIC Package Diagram Dimensions<sup>1, 2, 3, 4</sup>**

Dimension	Min	Max
A	—	2.65
A1	0.10	0.30
A2	2.05	—
b	0.31	0.51
c	0.20	0.33
D	10.30 BSC	
E	10.30 BSC	
E1	7.50 BSC	
e	1.27 BSC	
L	0.40	1.27
h	0.25	0.75
$\theta$	0°	8°
aaa	—	0.10
bbb	—	0.33
ccc	—	0.10
ddd	—	0.25
eee	—	0.10
fff	—	0.20

**Note:**

1. All dimensions shown are in millimeters (mm) unless otherwise noted.
2. Dimensioning and Tolerancing per ANSI Y14.5M-1994.
3. This drawing conforms to JEDEC Outline MS-013, Variation AA.
4. Recommended reflow profile per JEDEC J-STD-020 specification for small body, lead-free components.

## 7. Land Pattern: 16-Pin Wide Body SOIC

The figure below illustrates the recommended land pattern details for the Si863x in a 16-pin wide-body SOIC package. The table lists the values for the dimensions shown in the illustration.



**Figure 7.1. PCB Land Pattern: 16-Pin Wide Body SOIC**

**Table 7.1. 16-Pin Wide Body SOIC Land Pattern Dimensions<sup>1, 2</sup>**

Dimension	Feature	(mm)
C1	Pad Column Spacing	9.40
E	Pad Row Pitch	1.27
X1	Pad Width	0.60
Y1	Pad Length	1.90

**Note:**

1. This Land Pattern Design is based on IPC-7351 pattern SOIC127P1032X265-16AN for Density Level B (Median Land Protrusion).
2. All feature sizes shown are at Maximum Material Condition (MMC) and a card fabrication tolerance of 0.05 mm is assumed.

### 8. Package Outline: 16-Pin Narrow Body SOIC

The figure below illustrates the package details for the Si863x in a 16-pin narrow-body SOIC (SO-16). The table lists the values for the dimensions shown in the illustration.



Figure 8.1. 16-Pin Narrow Body SOIC

**Table 8.1. 16-Pin Narrow Body SOIC Package Diagram Dimensions<sup>1, 2, 3, 4</sup>**

Dimension	Min	Max
A	—	1.75
A1	0.10	0.25
A2	1.25	—
b	0.31	0.51
c	0.17	0.25
D	9.90 BSC	
E	6.00 BSC	
E1	3.90 BSC	
e	1.27 BSC	
L	0.40	1.27
L2	0.25 BSC	
h	0.25	0.50
θ	0°	8°
aaa	0.10	
bbb	0.20	
ccc	0.10	
ddd	0.25	

1. All dimensions shown are in millimeters (mm) unless otherwise noted.
2. Dimensioning and Tolerancing per ANSI Y14.5M-1994.
3. This drawing conforms to the JEDEC Solid State Outline MS-012, Variation AC.
4. Recommended card reflow profile is per the JEDEC/IPC J-STD-020 specification for Small Body Components.

## 9. Land Pattern: 16-Pin Narrow Body SOIC

The figure below illustrates the recommended land pattern details for the Si863x in a 16-pin narrow-body SOIC package. The table lists the values for the dimensions shown in the illustration.

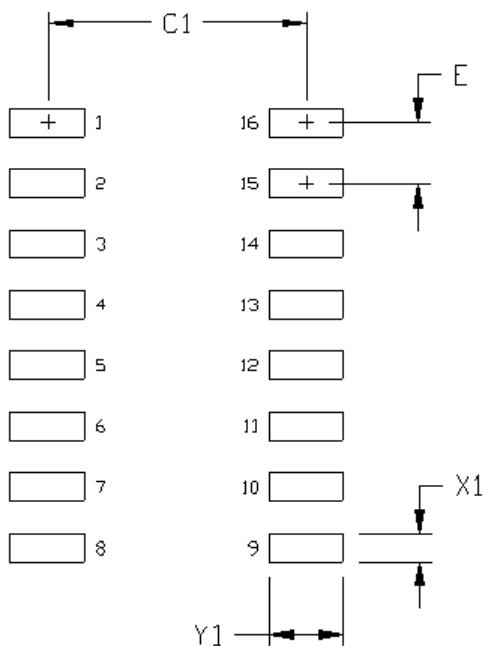

**Figure 9.1. PCB Land Pattern: 16-Pin Narrow Body SOIC**

**Table 9.1. 16-Pin Narrow Body SOIC Land Pattern Dimensions<sup>1, 2</sup>**

Dimension	Feature	(mm)
C1	Pad Column Spacing	5.40
E	Pad Row Pitch	1.27
X1	Pad Width	0.60
Y1	Pad Length	1.55

**Note:**

1. This Land Pattern Design is based on IPC-7351 pattern SOIC127P600X165-16N for Density Level B (Median Land Protrusion).

2. All feature sizes shown are at Maximum Material Condition (MMC) and a card fabrication tolerance of 0.05 mm is assumed.

## 10. Top Marking: 16-Pin Wide Body SOIC

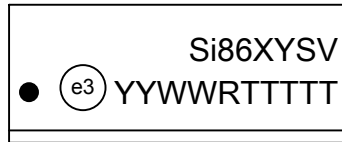

Figure 10.1. 16-Pin Wide Body SOIC Top Marking

Table 10.1. 16-Pin Wide Body SOIC Top Marking Explanation

<b>Line 1 Marking:</b>	Base Part Number	Si86 = Isolator product series
	Ordering Options  (See <a href="#">1. Ordering Guide</a> for more information.)	X = # of data channels (3)  Y = # of reverse channels (5, 1, 0) <sup>1</sup>  S = Speed Grade (max data rate) and operating mode: B = 150 Mbps (default output = low) E = 150 Mbps (default output = high)  V = Insulation rating B = 2.5 kV; C = 3.75 kV; D = 5.0 kV; T = 5.0 kV with 10 kV surge capability.
<b>Line 2 Marking:</b>	YY = Year  WW = Workweek	Assigned by assembly subcontractor. Corresponds to the year and workweek of the mold date.
	RTTTTT = Mfg Code	Manufacturing code from assembly house  “R” indicates revision
<b>Line 3 Marking:</b>	Circle = 1.7 mm Diameter  (Center-Justified)	“e4” Pb-Free Symbol
	Country of Origin ISO Code Abbreviation	CC = Country of Origin ISO Code Abbreviation • TW = Taiwan • TH = Thailand
<b>Note:</b> 1. Si8635 has 0 reverse channels.		

## 11. Top Marking: 16-Pin Narrow Body SOIC



**Figure 11.1. 16-Pin Narrow Body SOIC Top Marking**

**Table 11.1. 16-Pin Narrow Body SOIC Top Marking Explanation**

<b>Line 1 Marking:</b>	Base Part Number	Si86 = Isolator product series
	Ordering Options  (See <a href="#">1. Ordering Guide</a> for more information.)	XY = Channel Configuration X = # of data channels (3) Y = # of reverse channels (5, 1, 0) <sup>1</sup>  S = Speed Grade (max data rate) and operating mode: B = 150 Mbps (default output = low) E = 150 Mbps (default output = high)  V = Insulation rating B = 2.5 kV; C = 3.75 kV
	<b>Line 2 Marking:</b>	Circle = 1.2 mm Diameter
	YY = Year	“e3” Pb-Free Symbol
	WW = Work Week	Assigned by the Assembly House. Corresponds to the year and work week of the mold date.
	RTTTTT = Mfg Code	Manufacturing code from assembly house “R” indicates revision
<b>Note:</b> 1. Si8635 has 0 reverse channels.		

## 12. Revision History

### Revision A

March 2023

- Initial release into Agile PLM

### Revision 1.84

June 2021

- Increased IDD1 max spec for Si8630xT/35xT from 3.9 mA to 4.9 mA for > 10 Mbps operation, based on production data.
- A row was added to the [Table 3.1 Si86xx Logic Operation on page 7](#) to define the condition when both VDDs are powered up but input is left not connected.
- Specified that 2  $\mu$ A pull-ups/downs are integrated to enable the default high/low functions in Note 9, [Table 3.1 Si86xx Logic Operation on page 7](#)
- A separate row was added to the VIOTM spec in [Table 4.8 VDE 0884-10 Insulation Characteristics for Si86xx<sup>1</sup> on page 23](#) for all Si86xxxT devices, value = 8000 V

### Revision 1.83

September 2019

- Updated Ordering Guide.

### Revision 1.82

March 2019

- Corrected document title.

### Revision 1.81

January 2018

- Added new table to Ordering Guide for Automotive-Grade OPN options.

### Revision 1.8

November 30th, 2016

- Added note to Ordering Guide table for denoting tape and reel marking.

### Revision 1.7

July 19, 2016

- Added "R" part to the Ordering Guide.

### Revision 1.6

October 29, 2015

- Added product options Si863xxT in [1. Ordering Guide](#).
- Added spec line items for Input and Enable Leakage Currents pertaining to Si863xxT in [4. Electrical Specifications](#).
- Added new spec for  $t_{SD}$  in Electrical Specifications
- Updated IEC 60747-5-2 to IEC 60747-5-5 in all instances in document

### Revision 1.5

June 6, 2015

- Updated Table 5 on page 14.
  - Added CQC certificate numbers.
- Updated "4. Ordering Guide" on page 10.
  - Removed references to moisture sensitivity levels.
  - Removed Note 2.

### Revision 1.4

September 25, 2013

- Added Figure 3, "Common-Mode Transient Immunity Test Circuit," on page 8.
- Added references to CQC throughout.
- Added references to 2.5 kVRMS devices throughout.
- Updated "4. Ordering Guide" on page 10.
- Updated "9.1. Si863x Top Marking (16-Pin Wide Body SOIC)" on page 17.

### Revision 1.3

June 26, 2012

- Updated Table 11 on page 20.
  - Added junction temperature spec.
- Updated "2.3.1. Supply Bypass" on page 7.
- Removed "3.3.2. Pin Connections" on page 23.
- Updated "3. Pin Descriptions" on page 9.
  - Updated table notes.
- Updated "4. Ordering Guide" on page 10.
  - Removed Rev A devices.

- Updated "6. Land Pattern: 16-Pin Wide-Body SOIC" on page 13.
- Updated Top Marks.
  - Added revision description.

### **Revision 1.2**

March 21, 2012

- Updated "4. Ordering Guide" on page 10 to include MSL2A.

### **Revision 1.1**

September 14, 2011

- Updated High Level Output Voltage VOH to 3.1 V in Table 3, "Electrical Characteristics," on page 9.
- Updated High Level Output Voltage VOH to 2.3 V in Table 4, "Electrical Characteristics," on page 12.

### **Revision 1.0**

July 14, 2011

- Reordered spec tables to conform to new convention.
- Removed "pending" throughout document.

### **Revision 0.2**

March 31, 2011

- Added chip graphics on page 1.
- Moved Tables 1 and 11 to page 20.
- Updated Table 6, "Insulation and Safety-Related Specifications," on page 17.
- Updated Table 8, "IEC 60747-5-5 Insulation Characteristics for Si86xxxx\*," on page 18.
- Moved Table 1 to page 4.
- Moved Table 2 to page 5.
- Moved "Typical Performance Characteristics" to page 8.
- Updated "3. Pin Descriptions" on page 9.
- Updated "4. Ordering Guide" on page 10.
- Removed references to QSOP-16 package.

### **Revision 0.1**

September 15, 2010

- Initial release.



**Connecting Everyone  
and Everything,  
All the Time**



**Portfolio**

[skyworksinc.com](http://skyworksinc.com)



**Quality**

[skyworksinc.com/quality](http://skyworksinc.com/quality)



**Support & Resources**

[skyworksinc.com/support](http://skyworksinc.com/support)

**Copyright © 2023 Skyworks Solutions, Inc. All Rights Reserved.**

Information in this document is provided in connection with Skyworks Solutions, Inc. ("Skyworks") products or services. These materials, including the information contained herein, are provided by Skyworks as a service to its customers and may be used for informational purposes only by the customer. Skyworks assumes no responsibility for errors or omissions in these materials or the information contained herein. Skyworks may change its documentation, products, services, specifications or product descriptions at any time, without notice. Skyworks makes no commitment to update the materials or information and shall have no responsibility whatsoever for conflicts, incompatibilities, or other difficulties arising from any future changes.

No license, whether express, implied, by estoppel or otherwise, is granted to any intellectual property rights by this document. Skyworks assumes no liability for any materials, products or information provided hereunder, including the sale, distribution, reproduction or use of Skyworks products, information or materials, except as may be provided in Skyworks' Terms and Conditions of Sale.

THE MATERIALS, PRODUCTS AND INFORMATION ARE PROVIDED "AS IS" WITHOUT WARRANTY OF ANY KIND, WHETHER EXPRESS, IMPLIED, STATUTORY, OR OTHERWISE, INCLUDING FITNESS FOR A PARTICULAR PURPOSE OR USE, MERCHANTABILITY, PERFORMANCE, QUALITY OR NON-INFRINGEMENT OF ANY INTELLECTUAL PROPERTY RIGHT; ALL SUCH WARRANTIES ARE HEREBY EXPRESSLY DISCLAIMED. SKYWORKS DOES NOT WARRANT THE ACCURACY OR COMPLETENESS OF THE INFORMATION, TEXT, GRAPHICS OR OTHER ITEMS CONTAINED WITHIN THESE MATERIALS. SKYWORKS SHALL NOT BE LIABLE FOR ANY DAMAGES, INCLUDING BUT NOT LIMITED TO ANY SPECIAL, INDIRECT, INCIDENTAL, STATUTORY, OR CONSEQUENTIAL DAMAGES, INCLUDING WITHOUT LIMITATION, LOST REVENUES OR LOST PROFITS THAT MAY RESULT FROM THE USE OF THE MATERIALS OR INFORMATION, WHETHER OR NOT THE RECIPIENT OF MATERIALS HAS BEEN ADVISED OF THE POSSIBILITY OF SUCH DAMAGE.

Skyworks products are not intended for use in medical, lifesaving or life-sustaining applications, or other equipment in which the failure of the Skyworks products could lead to personal injury, death, physical or environmental damage. Skyworks customers using or selling Skyworks products for use in such applications do so at their own risk and agree to fully indemnify Skyworks for any damages resulting from such improper use or sale.

Customers are responsible for their products and applications using Skyworks products, which may deviate from published specifications as a result of design defects, errors, or operation of products outside of published parameters or design specifications. Customers should include design and operating safeguards to minimize these and other risks. Skyworks assumes no liability for applications assistance, customer product design, or damage to any equipment resulting from the use of Skyworks products outside of Skyworks' published specifications or parameters.

Skyworks, the Skyworks symbol, Sky5®, SkyOne®, SkyBlue™, Skyworks Green™, ClockBuilder®, DSPLL®, ISOmodem®, ProSLIC®, and SiPHY® are trademarks or registered trademarks of Skyworks Solutions, Inc. or its subsidiaries in the United States and other countries. Third-party brands and names are for identification purposes only and are the property of their respective owners. Additional information, including relevant terms and conditions, posted at [www.skyworksinc.com](http://www.skyworksinc.com), are incorporated by reference.

Skyworks Solutions, Inc. | Nasdaq: SWKS | [sales@skyworksinc.com](mailto:sales@skyworksinc.com) | [www.skyworksinc.com](http://www.skyworksinc.com)

USA: 781-376-3000 | Asia: 886-2-2735 0399 | Europe: 33 (0)1 43548540

## Looking for pricing, stock, or lifecycle information?

Click below to explore more details on WIN SOURCE:

 [View SI8635BC-B-ISR](#) on WIN SOURCE

 [Silicon Labs](#) Information

## Optimize Your Supply Chain with WIN SOURCE Solutions

-  Global Sourcing Solution
-  Obsolete Management
-  Cost Control Management
-  Shortage Management
-  Alternative Solution
-  Excess Inventory Management