



**THE DATASHEET OF
CY74FCT162245ATPVC**



Features

- I_{off} supports partial-power-down mode operation
- Edge-rate control circuitry for significantly improved noise characteristics
- Typical output skew < 250 ps
- ESD > 2000V
- TSSOP (19.6-mil pitch) and SSOP (25-mil pitch) packages
- Industrial temperature range of -40°C to $+85^{\circ}\text{C}$
- $V_{CC} = 5\text{V} \pm 10\%$

CY74FCT16245T Features:

- 64 mA sink current, 32 mA source current
- Typical V_{OLP} (ground bounce) < 1.0V at $V_{CC} = 5\text{V}$, $T_A = 25^{\circ}\text{C}$

CY74FCT162245T Features:

- Balanced output drivers: 24 mA
- Reduced system switching noise
- Typical V_{OLP} (ground bounce) < 0.6V at $V_{CC} = 5\text{V}$, $T_A = 25^{\circ}\text{C}$

CY74FCT162H245T Features:

- Bus hold on data inputs
- Eliminates the need for external pull-up or pull-down resistors

Functional Description

These 16-bit transceivers are designed for use in bidirectional synchronous communication between two buses, where high speed and low power are required. With the exception of the CY74FCT16245T, these devices can be operated either as two independent octals or a single 16-bit transceiver. Direction of data flow is controlled by (DIR), the Output Enable ($\overline{\text{OE}}$) transfers data when LOW and isolates the buses when HIGH.

This device is fully specified for partial-power-down applications using I_{off} . The I_{off} circuitry disables the outputs, preventing damaging current backflow through the device when it is powered down.

The CY74FCT16245T is ideally suited for driving high-capacitance loads and low-impedance backplanes.

The CY74FCT162245T has 24-mA balanced output drivers with current limiting resistors in the outputs. This reduces the need for external terminating resistors and provides for minimal undershoot and reduced ground bounce. The CY74FCT162245T is ideal for driving transmission lines.

The CY74FCT162H245T is a 24-mA balanced output part that has bus hold on the data inputs. The device retains the input's last state whenever the input goes to high impedance. This eliminates the need for pull-up/down resistors and prevents floating inputs.

Logic Block Diagrams CY74FCT16245T, CY74FCT162245T, CY74FCT162H245T

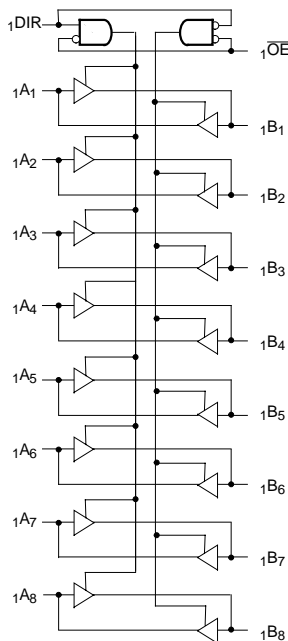

FCT16245-1

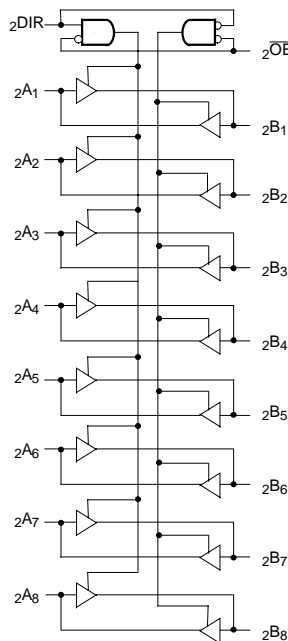

FCT16245-2

Pin Configuration

SSOP/TSSOP Top View

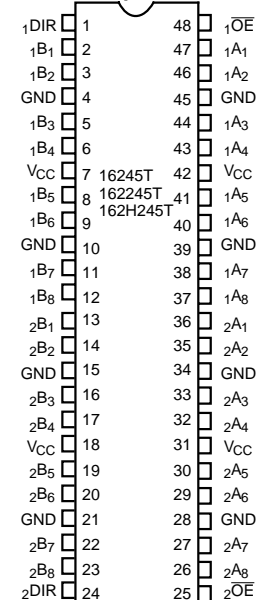

FCT16245-3

Pin Description

Name	Description
OE	Three-State Output Enable Inputs (Active LOW)
DIR	Direction Control
A	Inputs or Three-State Outputs ^[1]
B	Inputs or Three-State Outputs ^[1]

Function Table^[2]

Inputs		Outputs
OE	DIR	
L	L	Bus B Data to Bus A
L	H	Bus A Data to Bus B
H	X	High Z State

Maximum Ratings^[3, 4]

(Above which the useful life may be impaired. For user guidelines, not tested.)

Storage Temperature Com'l -55°C to +125°C

Ambient Temperature with Power Applied..... Com'l -55°C to +125°C

DC Input Voltage -0.5V to +7.0V

DC Output Voltage..... -0.5V to +7.0V

DC Output Current (Maximum Sink Current/Pin) -60 to +120 mA

Power Dissipation 1.0W

Static Discharge Voltage..... >2001V (per MIL-STD-883, Method 3015)

Operating Range

Range	Ambient Temperature	V _{CC}
Industrial	-40°C to +85°C	5V ± 10%

Notes:

- On CY74FCT162H245T these pins have bus hold.
- H = HIGH Voltage Level. L = LOW Voltage Level. X = Don't Care. Z = High Impedance.
- Operation beyond the limits set forth may impair the useful life of the device. Unless otherwise noted, these limits are over the operating free-air temperature range.
- Unused inputs must always be connected to an appropriate logic voltage level, preferably either V_{CC} or ground.

Electrical Characteristics Over the Operating Range

Parameter	Description	Test Conditions	Min.	Typ. ^[5]	Max.	Unit	
V _{IH}	Input HIGH Voltage		2.0			V	
V _{IL}	Input LOW Voltage				0.8	V	
V _H	Input Hysteresis ^[6]			100		mV	
V _{IK}	Input Clamp Diode Voltage	V _{CC} =Min., I _{IN} =-18 mA		-0.7	-1.2	V	
I _{IH}	Input HIGH Current	Standard	V _{CC} =Max., V _I =V _{CC}		±1	μA	
		Bus Hold			±100		
I _{IL}	Input LOW Current	Standard	V _{CC} =Max., V _I =GND		±1	μA	
		Bus Hold			±100	μA	
I _{BBH} I _{BBL}	Bus Hold Sustain Current on Bus Hold Input ^[7]	V _{CC} =Min.	V _I =2.0V V _I =0.8V	-50 +50		μA	
I _{BHHO} I _{BHLO}	Bus Hold Overdrive Current on Bus Hold Input ^[7]	V _{CC} =Max., V _I =1.5V			TBD	mA	
I _{OZH}	High Impedance Output Current (Three-State Output pins)	V _{CC} =Max., V _{OUT} =2.7V			±1	μA	
I _{OZL}	High Impedance Output Current (Three-State Output pins)	V _{CC} =Max., V _{OUT} =0.5V			±1	μA	
I _{OS}	Short Circuit Current ^[8]	V _{CC} =Max., V _{OUT} =GND		-80	-140	-200	mA
I _O	Output Drive Current ^[8]	V _{CC} =Max., V _{OUT} =2.5V		-50		-180	mA
I _{OFF}	Power-Off Disable	V _{CC} =0V, V _{OUT} ≤4.5V ^[9]				±1	μA

Output Drive Characteristics for CY74FCT16245T

Parameter	Description	Test Conditions	Min.	Typ. ^[5]	Max.	Unit
V _{OH}	Output HIGH Voltage	V _{CC} =Min., I _{OH} =-3 mA	2.5	3.5		V
		V _{CC} =Min., I _{OH} =-15 mA	2.4	3.5		V
		V _{CC} =Min., I _{OH} =-32 mA	2.0	3.0		V
V _{OL}	Output LOW Voltage	V _{CC} =Min., I _{OL} =64 mA		0.2	0.55	V

Output Drive Characteristics for CY74FCT162245T, CY74FCT162H245T

Parameter	Description	Test Conditions	Min.	Typ. ^[5]	Max.	Unit
I _{ODL}	Output LOW Current ^[8]	V _{CC} =5V, V _{IN} =V _{IH} or V _{IL} , V _{OUT} =1.5V	60	115	150	mA
I _{ODH}	Output HIGH Current ^[8]	V _{CC} =5V, V _{IN} =V _{IH} or V _{IL} , V _{OUT} =1.5V	-60	-115	-150	mA
V _{OH}	Output HIGH Voltage	V _{CC} =Min., I _{OH} =-24 mA	2.4	3.3		V
V _{OL}	Output LOW Voltage	V _{CC} =Min., I _{OL} =24 mA		0.3	0.55	V

Notes:

5. Typical values are at V_{CC}=5.0V, T_A=+25°C ambient.
6. This parameter is specified but not tested.
7. Pins with bus hold are described in Pin Description.
8. Not more than one output should be shorted at a time. Duration of short should not exceed one second. The use of high-speed test apparatus and/or sample and hold techniques are preferable in order to minimize internal chip heating and more accurately reflect operational values. Otherwise prolonged shorting of a high output may raise the chip temperature well above normal and thereby cause invalid readings in other parametric tests. In any sequence of parameter tests, I_{OS} tests should be performed last.
9. Tested at +25°C.

Capacitance^[6] (T_A = +25°C, f = 1.0 MHz)

Parameter	Description	Test Conditions	Typ. ^[5]	Max.	Unit
C _{IN}	Input Capacitance	V _{IN} = 0V	4.5	6.0	pF
C _{OUT}	Output Capacitance	V _{OUT} = 0V	5.5	8.0	pF

Power Supply Characteristics

Parameter	Description	Test Conditions	Typ. ^[5]	Max.	Unit	
I_{CC}	Quiescent Power Supply Current	$V_{CC}=\text{Max.}$ $V_{IN}\leq 0.2V$, $V_{IN}\geq V_{CC}-0.2V$	5	500	μA	
ΔI_{CC}	Quiescent Power Supply Current (TTL inputs HIGH)	$V_{CC}=\text{Max.}$ $V_{IN}=3.4V^{[10]}$	0.5	1.5	mA	
I_{CCD}	Dynamic Power Supply Current ^[11]	$V_{CC}=\text{Max.}$, One Input Toggling, 50% Duty Cycle, Outputs Open, $OE=DIR=GND$	$V_{IN}=V_{CC}$ or $V_{IN}=GND$	60	100	$\mu A/MHz$
I_C	Total Power Supply Current ^[12]	$V_{CC}=\text{Max.}$, $f_1=10$ MHz, 50% Duty Cycle, Outputs Open, One Bit Toggling, $OE=DIR=GND$	$V_{IN}=V_{CC}$ or $V_{IN}=GND$	0.6	1.5	mA
			$V_{IN}=3.4V$ or $V_{IN}=GND$	0.9	2.3	mA
		$V_{CC}=\text{Max.}$, $f_1=2.5$ MHz, 50% Duty Cycle, Outputs Open, Sixteen Bits Toggling, $OE=DIR=GND$	$V_{IN}=V_{CC}$ or $V_{IN}=GND$	2.4	4.5 ^[13]	mA
			$V_{IN}=3.4V$ or $V_{IN}=GND$	6.4	16.5 ^[13]	mA

Notes:

10. Per TTL driven input ($V_{IN}=3.4V$); all other inputs at V_{CC} or GND.
11. This parameter is not directly testable, but is derived for use in Total Power Supply calculations.
12. $I_C = I_{QUIESCENT} + I_{INPUTS} + I_{DYNAMIC}$
 $I_C = I_{CC} + \Delta I_{CC} D_H N_T + I_{CCD}(f_0/2 + f_1 N_1)$
 I_{CC} = Quiescent Current with CMOS input levels
 ΔI_{CC} = Power Supply Current for a TTL HIGH input ($V_{IN}=3.4V$)
 D_H = Duty Cycle for TTL inputs HIGH
 N_T = Number of TTL inputs at D_H
 I_{CCD} = Dynamic Current caused by an input transition pair (HLH or LHL)
 f_0 = Clock frequency for registered devices, otherwise zero
 f_1 = Input signal frequency
 N_1 = Number of inputs changing at f_1
 All currents are in milliamps and all frequencies are in megahertz.
13. Values for these conditions are examples of the I_{CC} formula. These limits are specified but not tested.

Switching Characteristics Over the Operating Range^[14]

Parameter	Description	74FCT16245T 74FCT162245T		74FCT16245AT 74FCT162245AT 74FCT162H245AT		Unit	Fig. No. ^[15]
		Min.	Max.	Min.	Max.		
t _{PLH} t _{PHL}	Propagation Delay Data to Output A to B, B to A	1.5	7.0	1.5	4.5	ns	1, 3
t _{PZH} t _{PZL}	Output Enable Time OE to A or B	1.5	9.5	1.5	6.2	ns	1, 7, 8
t _{PHZ} t _{PLZ}	Output Disable Time OE to A or B	1.5	7.5	1.5	5.0	ns	1, 7, 8
t _{PZH} t _{PZL}	Output Enable Time DIR to A or B	1.5	9.5	1.5	6.2	ns	1, 7, 8
t _{PHZ} t _{PLZ}	Output Disable Time DIR to A or B	1.5	7.5	1.5	5.0	ns	1, 7, 8
t _{SK(O)}	Output Skew ^[16]		0.5		0.5	ns	—

Parameter	Description	74FCT16245CT 74FCT162245CT 74FCT162H245CT		Unit	Fig. No. ^[15]
		Min.	Max.		
t _{PLH} t _{PHL}	Propagation Delay Data to Output A to B, B to A	1.5	4.1	ns	1, 3
t _{PZH} t _{PZL}	Output Enable Time OE to A or B	1.5	5.8	ns	1, 7, 8
t _{PHZ} t _{PLZ}	Output Disable Time OE to A or B	1.5	4.8	ns	1, 7, 8
t _{PZH} t _{PZL}	Output Enable Time DIR to A or B	1.5	5.8	ns	1, 7, 8
t _{PHZ} t _{PLZ}	Output Disable Time DIR to A or B	1.5	4.8	ns	1, 7, 8
t _{SK(O)}	Output Skew ^[16]		0.5	ns	—

Note:

14. Minimum limits are specified but not tested on Propagation Delays.

15. See "Parameter Measurement Information" in the General Information section.

16. Skew between any two outputs of the same package switching in the same direction. This parameter is ensured by design.

Ordering Information CY74FCT16245

Speed (ns)	Ordering Code	Package Name	Package Type	Operating Range
4.1	CY74FCT16245CTPACT	Z48	48-Lead (240-Mil) TSSOP	Industrial
	CY74FCT16245CTPVC/PVCT	O48	48-Lead (300-Mil) SSOP	
4.5	CY74FCT16245ATPACT	Z48	48-Lead (240-Mil) TSSOP	Industrial
	CY74FCT16245ATPVC/PVCT	O48	48-Lead (300-Mil) SSOP	
7.0	CY74FCT16245TPACT	Z48	48-Lead (240-Mil) TSSOP	Industrial
	CY74FCT16245TPVC/PVCT	O48	48-Lead (300-Mil) SSOP	

Ordering Information CY74FCT162245

Speed (ns)	Ordering Code	Package Name	Package Type	Operating Range
4.1	CY74FCT162245CTPACT	Z48	48-Lead (240-Mil) TSSOP	Industrial
	CY74FCT162245CTPVC	O48	48-Lead (300-Mil) SSOP	
	74FCT162245CTPVCT	O48	48-Lead (300-Mil) SSOP	
4.5	74FCT162245ATPACT	Z48	48-Lead (240-Mil) TSSOP	Industrial
	CY74FCT162245ATPVC	O48	48-Lead (300-Mil) SSOP	
	74FCT162245ATPVCT	O48	48-Lead (300-Mil) SSOP	
7.0	CY74FCT162245TPACT	Z48	48-Lead (240-Mil) TSSOP	Industrial
	CY74FCT162245TPVC/PVCT	O48	48-Lead (300-Mil) SSOP	

Ordering Information CY74FCT162H245

Speed (ns)	Ordering Code	Package Name	Package Type	Operating Range
4.1	74FCT162H245CTPACT	Z48	48-Lead (240-Mil) TSSOP	Industrial
	CY74FCT162H245CTPVC	O48	48-Lead (300-Mil) SSOP	
	74FCT162H245CTPVCT	O48	48-Lead (300-Mil) SSOP	
4.5	74FCT162H245ATPACT	Z48	48-Lead (240-Mil) TSSOP	Industrial
	CY74FCT162H245ATPVC	O48	48-Lead (300-Mil) SSOP	
	74FCT162H245ATPVCT	O48	48-Lead (300-Mil) SSOP	

Package Diagrams

48-Lead Shrunken Small Outline Package O48

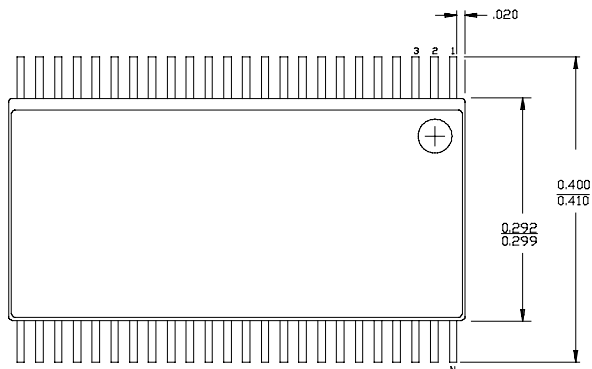

DIMENSIONS IN INCHES MIN.
MAX.

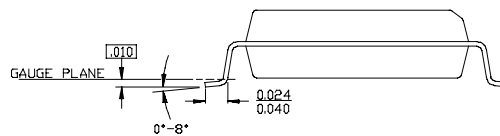
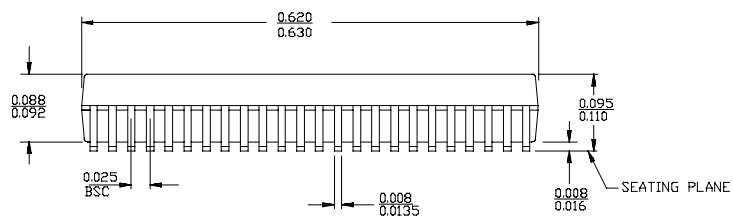

Package Diagrams

48-Lead Thin Shrunk Small Outline Package Z48

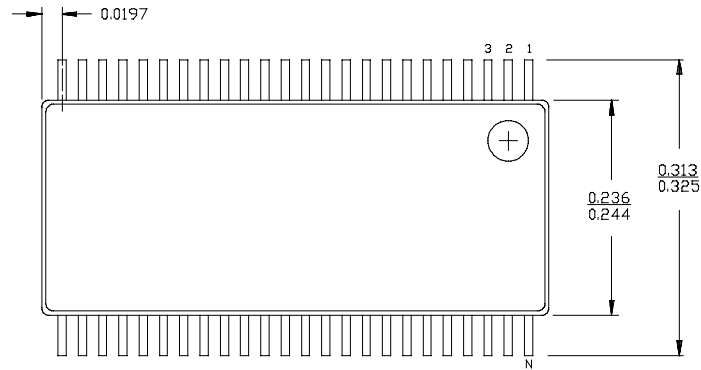

DIMENSIONS IN INCHES MIN.
MAX.

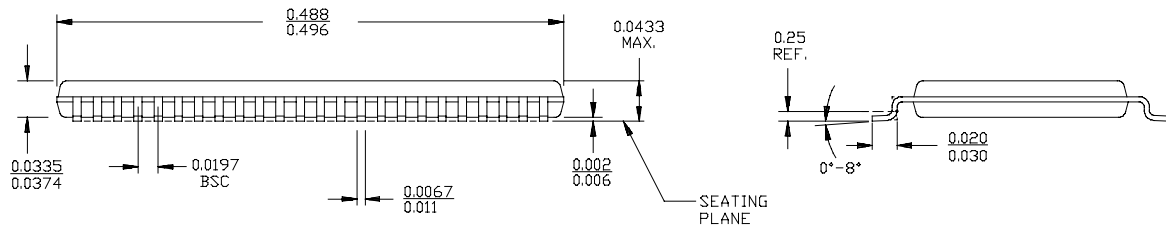

PACKAGING INFORMATION

Orderable Device	Status (1)	Package Type	Package Drawing	Pins	Package Qty	Eco Plan (2)	Lead/Ball Finish (6)	MSL Peak Temp (3)	Op Temp (°C)	Device Marking (4/5)	Samples
74FCT162245ATPACT	ACTIVE	TSSOP	DGG	48	2000	Green (RoHS & no Sb/Br)	CU NIPDAU	Level-1-260C-UNLIM	-40 to 85	FCT162245A	Samples
74FCT162245ATPVCT	ACTIVE	SSOP	DL	48	1000	Green (RoHS & no Sb/Br)	CU NIPDAU	Level-1-260C-UNLIM	-40 to 85	FCT162245A	Samples
74FCT162245CTPACT	ACTIVE	TSSOP	DGG	48	2000	Green (RoHS & no Sb/Br)	CU NIPDAU	Level-1-260C-UNLIM	-40 to 85	FCT162245C	Samples
74FCT162245CTPVCG4	ACTIVE	SSOP	DL	48	25	Green (RoHS & no Sb/Br)	CU NIPDAU	Level-1-260C-UNLIM	-40 to 85	FCT162245C	Samples
74FCT16245CTPVCTG4	ACTIVE	SSOP	DL	48	1000	Green (RoHS & no Sb/Br)	CU NIPDAU	Level-1-260C-UNLIM	-40 to 85	FCT16245C	Samples
74FCT16245TPACTE4	ACTIVE	TSSOP	DGG	48	2000	Green (RoHS & no Sb/Br)	CU NIPDAU	Level-1-260C-UNLIM	-40 to 85	FCT16245	Samples
74FCT16245TPVCG4	ACTIVE	SSOP	DL	48	25	Green (RoHS & no Sb/Br)	CU NIPDAU	Level-1-260C-UNLIM	-40 to 85	FCT16245	Samples
74FCT162H245ATPACT	ACTIVE	TSSOP	DGG	48	2000	Green (RoHS & no Sb/Br)	CU NIPDAU	Level-1-260C-UNLIM	-40 to 85	FCT162H245A	Samples
74FCT162H245ATPVC	ACTIVE	SSOP	DL	48	25	Green (RoHS & no Sb/Br)	CU NIPDAU	Level-1-260C-UNLIM	-40 to 85	FCT162H245A	Samples
74FCT162H245CTPACT	ACTIVE	TSSOP	DGG	48	2000	Green (RoHS & no Sb/Br)	CU NIPDAU	Level-1-260C-UNLIM	-40 to 85	FCT162H245C	Samples
74FCT162H245CTPVC	ACTIVE	SSOP	DL	48	25	Green (RoHS & no Sb/Br)	CU NIPDAU	Level-1-260C-UNLIM	-40 to 85	FCT162H245C	Samples
CY74FCT162245ATPVC	ACTIVE	SSOP	DL	48	25	Green (RoHS & no Sb/Br)	CU NIPDAU	Level-1-260C-UNLIM	-40 to 85	FCT162245A	Samples
CY74FCT162245CTPVC	ACTIVE	SSOP	DL	48	25	Green (RoHS & no Sb/Br)	CU NIPDAU	Level-1-260C-UNLIM	-40 to 85	FCT162245C	Samples
CY74FCT162245TPACT	ACTIVE	TSSOP	DGG	48	2000	Green (RoHS & no Sb/Br)	CU NIPDAU	Level-1-260C-UNLIM	-40 to 85	FCT162245	Samples
CY74FCT162245TPVC	ACTIVE	SSOP	DL	48	25	Green (RoHS & no Sb/Br)	CU NIPDAU	Level-1-260C-UNLIM	-40 to 85	FCT162245	Samples
CY74FCT162245TPVCT	ACTIVE	SSOP	DL	48	1000	Green (RoHS & no Sb/Br)	CU NIPDAU	Level-1-260C-UNLIM	-40 to 85	FCT162245	Samples
CY74FCT16245ATPACT	ACTIVE	TSSOP	DGG	48	2000	Green (RoHS & no Sb/Br)	CU NIPDAU	Level-1-260C-UNLIM	-40 to 85	FCT16245A	Samples

Orderable Device	Status (1)	Package Type	Package Drawing	Pins	Package Qty	Eco Plan (2)	Lead/Ball Finish (6)	MSL Peak Temp (3)	Op Temp (°C)	Device Marking (4/5)	Samples
CY74FCT16245ATPVC	ACTIVE	SSOP	DL	48	25	Green (RoHS & no Sb/Br)	CU NIPDAU	Level-1-260C-UNLIM	-40 to 85	FCT16245A	Samples
CY74FCT16245ATPVCT	ACTIVE	SSOP	DL	48	1000	Green (RoHS & no Sb/Br)	CU NIPDAU	Level-1-260C-UNLIM	-40 to 85	FCT16245A	Samples
CY74FCT16245CTPACT	ACTIVE	TSSOP	DGG	48	2000	Green (RoHS & no Sb/Br)	CU NIPDAU	Level-1-260C-UNLIM	-40 to 85	FCT16245C	Samples
CY74FCT16245CTPVC	ACTIVE	SSOP	DL	48	25	Green (RoHS & no Sb/Br)	CU NIPDAU	Level-1-260C-UNLIM	-40 to 85	FCT16245C	Samples
CY74FCT16245CTPVCT	ACTIVE	SSOP	DL	48	1000	Green (RoHS & no Sb/Br)	CU NIPDAU	Level-1-260C-UNLIM	-40 to 85	FCT16245C	Samples
CY74FCT16245TPACT	ACTIVE	TSSOP	DGG	48	2000	Green (RoHS & no Sb/Br)	CU NIPDAU	Level-1-260C-UNLIM	-40 to 85	FCT16245	Samples
CY74FCT16245TPVC	ACTIVE	SSOP	DL	48	25	Green (RoHS & no Sb/Br)	CU NIPDAU	Level-1-260C-UNLIM	-40 to 85	FCT16245	Samples
CY74FCT16245TPVCT	ACTIVE	SSOP	DL	48	1000	Green (RoHS & no Sb/Br)	CU NIPDAU	Level-1-260C-UNLIM	-40 to 85	FCT16245	Samples

(1) The marketing status values are defined as follows:

ACTIVE: Product device recommended for new designs.

LIFEBUY: TI has announced that the device will be discontinued, and a lifetime-buy period is in effect.

NRND: Not recommended for new designs. Device is in production to support existing customers, but TI does not recommend using this part in a new design.

PREVIEW: Device has been announced but is not in production. Samples may or may not be available.

OBSELETE: TI has discontinued the production of the device.

(2) **RoHS:** TI defines "RoHS" to mean semiconductor products that are compliant with the current EU RoHS requirements for all 10 RoHS substances, including the requirement that RoHS substance do not exceed 0.1% by weight in homogeneous materials. Where designed to be soldered at high temperatures, "RoHS" products are suitable for use in specified lead-free processes. TI may reference these types of products as "Pb-Free".

RoHS Exempt: TI defines "RoHS Exempt" to mean products that contain lead but are compliant with EU RoHS pursuant to a specific EU RoHS exemption.

Green: TI defines "Green" to mean the content of Chlorine (Cl) and Bromine (Br) based flame retardants meet JS709B low halogen requirements of <=1000ppm threshold. Antimony trioxide based flame retardants must also meet the <=1000ppm threshold requirement.

(3) MSL, Peak Temp. - The Moisture Sensitivity Level rating according to the JEDEC industry standard classifications, and peak solder temperature.

(4) There may be additional marking, which relates to the logo, the lot trace code information, or the environmental category on the device.

(5) Multiple Device Markings will be inside parentheses. Only one Device Marking contained in parentheses and separated by a "~" will appear on a device. If a line is indented then it is a continuation of the previous line and the two combined represent the entire Device Marking for that device.

⁽⁶⁾ Lead/Ball Finish - Orderable Devices may have multiple material finish options. Finish options are separated by a vertical ruled line. Lead/Ball Finish values may wrap to two lines if the finish value exceeds the maximum column width.

Important Information and Disclaimer: The information provided on this page represents TI's knowledge and belief as of the date that it is provided. TI bases its knowledge and belief on information provided by third parties, and makes no representation or warranty as to the accuracy of such information. Efforts are underway to better integrate information from third parties. TI has taken and continues to take reasonable steps to provide representative and accurate information but may not have conducted destructive testing or chemical analysis on incoming materials and chemicals. TI and TI suppliers consider certain information to be proprietary, and thus CAS numbers and other limited information may not be available for release.

In no event shall TI's liability arising out of such information exceed the total purchase price of the TI part(s) at issue in this document sold by TI to Customer on an annual basis.

TAPE AND REEL INFORMATION

QUADRANT ASSIGNMENTS FOR PIN 1 ORIENTATION IN TAPE

*All dimensions are nominal

Device	Package Type	Package Drawing	Pins	SPQ	Reel Diameter (mm)	Reel Width W1 (mm)	A0 (mm)	B0 (mm)	K0 (mm)	P1 (mm)	W (mm)	Pin1 Quadrant
74FCT162245ATPACT	TSSOP	DGG	48	2000	330.0	24.4	8.6	13.0	1.8	12.0	24.0	Q1
74FCT162245ATPVCT	SSOP	DL	48	1000	330.0	32.4	11.35	16.2	3.1	16.0	32.0	Q1
74FCT162245CTPACT	TSSOP	DGG	48	2000	330.0	24.4	8.6	13.0	1.8	12.0	24.0	Q1
74FCT162H245ATPACT	TSSOP	DGG	48	2000	330.0	24.4	8.6	13.0	1.8	12.0	24.0	Q1
74FCT162H245CTPACT	TSSOP	DGG	48	2000	330.0	24.4	8.6	13.0	1.8	12.0	24.0	Q1
CY74FCT162245TPACT	TSSOP	DGG	48	2000	330.0	24.4	8.6	13.0	1.8	12.0	24.0	Q1
CY74FCT162245TPVCT	SSOP	DL	48	1000	330.0	32.4	11.35	16.2	3.1	16.0	32.0	Q1
CY74FCT16245ATPACT	TSSOP	DGG	48	2000	330.0	24.4	8.6	13.0	1.8	12.0	24.0	Q1
CY74FCT16245ATPVCT	SSOP	DL	48	1000	330.0	32.4	11.35	16.2	3.1	16.0	32.0	Q1
CY74FCT16245CTPACT	TSSOP	DGG	48	2000	330.0	24.4	8.6	13.0	1.8	12.0	24.0	Q1
CY74FCT16245CTPVCT	SSOP	DL	48	1000	330.0	32.4	11.35	16.2	3.1	16.0	32.0	Q1
CY74FCT16245TPACT	TSSOP	DGG	48	2000	330.0	24.4	8.6	13.0	1.8	12.0	24.0	Q1
CY74FCT16245TPVCT	SSOP	DL	48	1000	330.0	32.4	11.35	16.2	3.1	16.0	32.0	Q1

TAPE AND REEL BOX DIMENSIONS

*All dimensions are nominal

Device	Package Type	Package Drawing	Pins	SPQ	Length (mm)	Width (mm)	Height (mm)
74FCT162245ATPACT	TSSOP	DGG	48	2000	367.0	367.0	45.0
74FCT162245ATPVCT	SSOP	DL	48	1000	367.0	367.0	55.0
74FCT162245CTPACT	TSSOP	DGG	48	2000	367.0	367.0	45.0
74FCT162H245ATPACT	TSSOP	DGG	48	2000	367.0	367.0	45.0
74FCT162H245CTPACT	TSSOP	DGG	48	2000	367.0	367.0	45.0
CY74FCT162245TPACT	TSSOP	DGG	48	2000	367.0	367.0	45.0
CY74FCT162245TPVCT	SSOP	DL	48	1000	367.0	367.0	55.0
CY74FCT16245ATPACT	TSSOP	DGG	48	2000	367.0	367.0	45.0
CY74FCT16245ATPVCT	SSOP	DL	48	1000	367.0	367.0	55.0
CY74FCT16245CTPACT	TSSOP	DGG	48	2000	367.0	367.0	45.0
CY74FCT16245CTPVCT	SSOP	DL	48	1000	367.0	367.0	55.0
CY74FCT16245TPACT	TSSOP	DGG	48	2000	367.0	367.0	45.0
CY74FCT16245TPVCT	SSOP	DL	48	1000	367.0	367.0	55.0

MECHANICAL DATA

DL (R-PDSO-G48)

PLASTIC SMALL-OUTLINE PACKAGE



- NOTES:
- All linear dimensions are in inches (millimeters).
 - This drawing is subject to change without notice.
 - Body dimensions do not include mold flash or protrusion not to exceed 0.006 (0,15).
 - Falls within JEDEC MO-118

PowerPAD is a trademark of Texas Instruments.

DGG (R-PDSO-G**)

PLASTIC SMALL-OUTLINE PACKAGE

48 PINS SHOWN



- NOTES: A. All linear dimensions are in millimeters.
 B. This drawing is subject to change without notice.
 C. Body dimensions do not include mold protrusion not to exceed 0,15.
 D. Falls within JEDEC MO-153

IMPORTANT NOTICE

Texas Instruments Incorporated (TI) reserves the right to make corrections, enhancements, improvements and other changes to its semiconductor products and services per JESD46, latest issue, and to discontinue any product or service per JESD48, latest issue. Buyers should obtain the latest relevant information before placing orders and should verify that such information is current and complete.

TI's published terms of sale for semiconductor products (<http://www.ti.com/sc/docs/stdterms.htm>) apply to the sale of packaged integrated circuit products that TI has qualified and released to market. Additional terms may apply to the use or sale of other types of TI products and services.

Reproduction of significant portions of TI information in TI data sheets is permissible only if reproduction is without alteration and is accompanied by all associated warranties, conditions, limitations, and notices. TI is not responsible or liable for such reproduced documentation. Information of third parties may be subject to additional restrictions. Resale of TI products or services with statements different from or beyond the parameters stated by TI for that product or service voids all express and any implied warranties for the associated TI product or service and is an unfair and deceptive business practice. TI is not responsible or liable for any such statements.

Buyers and others who are developing systems that incorporate TI products (collectively, "Designers") understand and agree that Designers remain responsible for using their independent analysis, evaluation and judgment in designing their applications and that Designers have full and exclusive responsibility to assure the safety of Designers' applications and compliance of their applications (and of all TI products used in or for Designers' applications) with all applicable regulations, laws and other applicable requirements. Designer represents that, with respect to their applications, Designer has all the necessary expertise to create and implement safeguards that (1) anticipate dangerous consequences of failures, (2) monitor failures and their consequences, and (3) lessen the likelihood of failures that might cause harm and take appropriate actions. Designer agrees that prior to using or distributing any applications that include TI products, Designer will thoroughly test such applications and the functionality of such TI products as used in such applications.

TI's provision of technical, application or other design advice, quality characterization, reliability data or other services or information, including, but not limited to, reference designs and materials relating to evaluation modules, (collectively, "TI Resources") are intended to assist designers who are developing applications that incorporate TI products; by downloading, accessing or using TI Resources in any way, Designer (individually or, if Designer is acting on behalf of a company, Designer's company) agrees to use any particular TI Resource solely for this purpose and subject to the terms of this Notice.

TI's provision of TI Resources does not expand or otherwise alter TI's applicable published warranties or warranty disclaimers for TI products, and no additional obligations or liabilities arise from TI providing such TI Resources. TI reserves the right to make corrections, enhancements, improvements and other changes to its TI Resources. TI has not conducted any testing other than that specifically described in the published documentation for a particular TI Resource.

Designer is authorized to use, copy and modify any individual TI Resource only in connection with the development of applications that include the TI product(s) identified in such TI Resource. NO OTHER LICENSE, EXPRESS OR IMPLIED, BY ESTOPPEL OR OTHERWISE TO ANY OTHER TI INTELLECTUAL PROPERTY RIGHT, AND NO LICENSE TO ANY TECHNOLOGY OR INTELLECTUAL PROPERTY RIGHT OF TI OR ANY THIRD PARTY IS GRANTED HEREIN, including but not limited to any patent right, copyright, mask work right, or other intellectual property right relating to any combination, machine, or process in which TI products or services are used. Information regarding or referencing third-party products or services does not constitute a license to use such products or services, or a warranty or endorsement thereof. Use of TI Resources may require a license from a third party under the patents or other intellectual property of the third party, or a license from TI under the patents or other intellectual property of TI.

TI RESOURCES ARE PROVIDED "AS IS" AND WITH ALL FAULTS. TI DISCLAIMS ALL OTHER WARRANTIES OR REPRESENTATIONS, EXPRESS OR IMPLIED, REGARDING RESOURCES OR USE THEREOF, INCLUDING BUT NOT LIMITED TO ACCURACY OR COMPLETENESS, TITLE, ANY EPIDEMIC FAILURE WARRANTY AND ANY IMPLIED WARRANTIES OF MERCHANTABILITY, FITNESS FOR A PARTICULAR PURPOSE, AND NON-INFRINGEMENT OF ANY THIRD PARTY INTELLECTUAL PROPERTY RIGHTS. TI SHALL NOT BE LIABLE FOR AND SHALL NOT DEFEND OR INDEMNIFY DESIGNER AGAINST ANY CLAIM, INCLUDING BUT NOT LIMITED TO ANY INFRINGEMENT CLAIM THAT RELATES TO OR IS BASED ON ANY COMBINATION OF PRODUCTS EVEN IF DESCRIBED IN TI RESOURCES OR OTHERWISE. IN NO EVENT SHALL TI BE LIABLE FOR ANY ACTUAL, DIRECT, SPECIAL, COLLATERAL, INDIRECT, PUNITIVE, INCIDENTAL, CONSEQUENTIAL OR EXEMPLARY DAMAGES IN CONNECTION WITH OR ARISING OUT OF TI RESOURCES OR USE THEREOF, AND REGARDLESS OF WHETHER TI HAS BEEN ADVISED OF THE POSSIBILITY OF SUCH DAMAGES.

Unless TI has explicitly designated an individual product as meeting the requirements of a particular industry standard (e.g., ISO/TS 16949 and ISO 26262), TI is not responsible for any failure to meet such industry standard requirements.

Where TI specifically promotes products as facilitating functional safety or as compliant with industry functional safety standards, such products are intended to help enable customers to design and create their own applications that meet applicable functional safety standards and requirements. Using products in an application does not by itself establish any safety features in the application. Designers must ensure compliance with safety-related requirements and standards applicable to their applications. Designer may not use any TI products in life-critical medical equipment unless authorized officers of the parties have executed a special contract specifically governing such use. Life-critical medical equipment is medical equipment where failure of such equipment would cause serious bodily injury or death (e.g., life support, pacemakers, defibrillators, heart pumps, neurostimulators, and implantables). Such equipment includes, without limitation, all medical devices identified by the U.S. Food and Drug Administration as Class III devices and equivalent classifications outside the U.S.

TI may expressly designate certain products as completing a particular qualification (e.g., Q100, Military Grade, or Enhanced Product). Designers agree that it has the necessary expertise to select the product with the appropriate qualification designation for their applications and that proper product selection is at Designers' own risk. Designers are solely responsible for compliance with all legal and regulatory requirements in connection with such selection.

Designer will fully indemnify TI and its representatives against any damages, costs, losses, and/or liabilities arising out of Designer's non-compliance with the terms and provisions of this Notice.

Looking for pricing, stock, or lifecycle information?

Click below to explore more details on WIN SOURCE:

 [View CY74FCT162245ATPVC on WIN SOURCE](#)

 [Texas Instruments](#) Information

Optimize Your Supply Chain with WIN SOURCE Solutions

-  Global Sourcing Solution
-  Obsolete Management
-  Cost Control Management
-  Shortage Management
-  Alternative Solution
-  Excess Inventory Management