



**THE DATASHEET OF
SI91872DMP-50-E3**



300-mA Low-Noise LDO Regulator With Error Flag and Discharge Option

FEATURES

- Ultra Low Dropout—300 mV at 300-mA Load
- Low Noise—75 μV_{RMS} (10-Hz to 100-kHz)
- Out-of-Regulation Error Flag (power good)
- Shutdown Control
- 130- μA Ground Current at 300-mA Load
- Fast Start-Up (50 μs)
- 1.5% Guaranteed Output Voltage Accuracy
- 400-mA Peak Output Current Capability
- Uses Low ESR Ceramic Capacitors
- Fast Line and Load Transient Response ($\leq 30 \mu\text{s}$)
- 1- μA Maximum Shutdown Current
- Output Current Limit
- Reverse Battery Protection
- Built-in Short Circuit and Thermal Protection



- Output—Auto-Discharge In Shutdown Mode
- Fixed 1.2, 1.8, 2.5, 2.6, 2.8, 3.0, 3.3, 5.0-V Output Voltage Options
- MLP33-5 PowerPAK® Package

APPLICATIONS

- Cellular Phones, Wireless Handsets
- Noise-Sensitive Electronic Systems, Laptop and Palmtop Computers
- PDAs
- Pagers
- Digital Cameras
- MP3 Player
- Wireless Modem

DESCRIPTION

The Si91872 is a 300-mA CMOS LDO (low dropout) voltage regulator. It is the perfect choice for low voltage, low power applications. An ultra low ground current and ultra fast turn-on make this part attractive for battery operated power systems. The Si91872 also offers ultra low dropout voltage to prolong battery life in portable electronics. Systems requiring a quiet voltage source will benefit from the Si91872's low output noise. The Si91872 is designed to maintain regulation while delivering 400-mA peak current, making it ideal for systems that have a high surge current upon turn-on.

voltage when it rises beyond normal regulation. The Si91872 automatically discharges the output voltage by connecting the output to ground through a 100- Ω n-channel MOSFET when the device is put in shutdown mode.

The Si91872 features reverse battery protection to limit reverse current flow to approximately 1- μA in the event reversed battery is applied at the input, thus preventing damage to the IC.

The Si91872 is available in both the standard and lead (Pb)-free 5-pin MLP33 PowerPAK packages and is specified to operate over the industrial temperature range of -40°C to 85°C .

For better transient response and regulation, an active pull-down circuit is built into the Si91872 to clamp the output

TYPICAL APPLICATION CIRCUIT

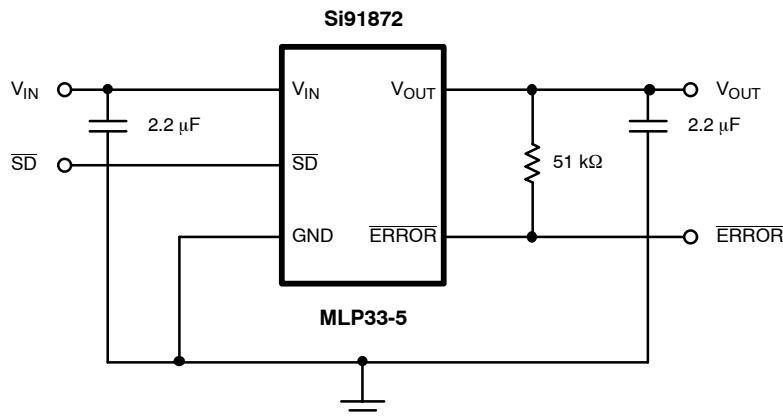

ABSOLUTE MAXIMUM RATINGS

Absolute Maximum Ratings	
Input Voltage, V_{IN} to GND	-6.0 to 6.5 V
V_{ERROR} , V_{SD} (See Detailed Description)	-0.3 V to V_{IN}
Output Current, I_{OUT}	Short Circuit Protected
Output Voltage, V_{OUT}	-0.3 V to $V_{IN} + 0.3$ V
Package Power Dissipation, $(P_d)^b$	2.3 W

Thermal Resistance (θ_{JA}) ^a	55°C/W
$R_{(\theta JA)}$ ^a	8°C/W
Maximum Junction Temperature, $T_{J(max)}$	150°C
Storage Temperature, T_{STG}	-65°C to 150°C

Notes

- a. Device mounted with all leads soldered or welded to PC board.
b. Derate 20 mW/°C above $T_A = 25^\circ\text{C}$

Stresses beyond those listed under "Absolute Maximum Ratings" may cause permanent damage to the device. These are stress ratings only, and functional operation of the device at these or any other conditions beyond those indicated in the operational sections of the specifications is not implied. Exposure to absolute maximum rating conditions for extended periods may affect device reliability.

RECOMMENDED OPERATING RANGE

Input Voltage, V_{IN}	2 V to 6 V
Input Voltage, V_{SD}	0 V to V_{IN}
Output Current	0 to 300 mA
C_{IN} , C_{OUT}^a (Ceramic)	2.2 μF

Operating Ambient Temperature, T_A -40°C to 85°C

Operating Junction Temperature, T_J -40°C to 125°C

Notes

- a. Maximum ESR of C_{OUT} : 0.2 Ω .

SPECIFICATIONS											
Parameter	Symbol	Test Conditions Unless Specified $T_A = 25^\circ\text{C}$, $V_{IN} = V_{OUT(nom)} + 1$ V, $I_{OUT} = 1$ mA, $C_{IN} = 2$ μF , $C_{OUT} = 2.0$ μF , $V_{SD} = 1.5$ V		Temp ^a	Limits -40 to 85°C			Unit			
					Min ^b	Typ ^c	Max ^b				
Input Voltage Range	V_{IN}			Full	2		6	V			
Output Voltage Accuracy		$1 \text{ mA} \leq I_{OUT} \leq 300 \text{ mA}$	$V_{OUT} \geq 1.8 \text{ V}$	Room	-2.0	1	2.0	%			
				Full	-3.0	1	3.0				
			$V_{OUT} = 1.2 \text{ V}, 1.5 \text{ V}$	Room	-2.5	1	2.5				
				Full	-3.5	1	3.5				
Line Regulation ($V_{OUT} \leq 3 \text{ V}$)	$\frac{\Delta V_{OUT} \times 100}{\Delta V_{IN} \times V_{OUT(nom)}}$	From $V_{IN} = V_{OUT(nom)} + 1$ V to $V_{OUT(nom)} + 2$ V	Full	-0.06		0.18	%V				
Line Regulation ($3.0 \text{ V} < V_{OUT} \leq 3.6 \text{ V}$)			Full	0		0.3					
Line Regulation (5-V Version)			Full	0		0.4					
Dropout Voltage ^{d, g} ($V_{OUT(nom)} \geq 2.6 \text{ V}$)	$V_{IN} - V_{OUT}$		$I_{OUT} = 1 \text{ mA}$	Room		1		mV			
				Full		45	80				
			$I_{OUT} = 50 \text{ mA}$	Room		50	90				
				Full		300	350				
$I_{OUT} = 300 \text{ mA}$			Room			415					
			Full			415					
Dropout Voltage ^{d, g} ($V_{OUT(nom)} < 2.6 \text{ V}$, $V_{IN} \geq 2 \text{ V}$)			$V_{IN} - V_{OUT}$		$I_{OUT} = 50 \text{ mA}$	Room			65	100	mV
						Full				120	
	$I_{OUT} = 300 \text{ mA}$	Room				400	520				
		Full					570				
Ground Pin Current ^{e, g} ($V_{OUT(nom)} \leq 3 \text{ V}$)	I_{GND}				$I_{OUT} = 0 \text{ mA}$	Room		100	150	μA	
						Full			180		
					$I_{OUT} = 300 \text{ mA}$	Room		130	200		
						Full			330		
Ground Pin Current ^{e, g} ($V_{OUT(nom)} > 3 \text{ V}$)			I_{GND}		$I_{OUT} = 0 \text{ mA}$	Room		110	170		μA
						Full			200		
					$I_{OUT} = 300 \text{ mA}$	Room		150	225		
						Full			275		
Peak Output current	$I_{O(peak)}$	$V_{OUT} \geq 0.95 \times V_{OUT(nom)}$, $t_{PW} = 2 \text{ ms}$			Full	400			mA		
Output Noise Voltage	e_N	$V_{OUT} = 2.6 \text{ V}$, BW = 10 Hz to 100 kHz, 0 mA < I_{OUT} < 150 mA			Room		75		$\mu\text{V(rms)}$		

SPECIFICATIONS								
Parameter	Symbol	Test Conditions Unless Specified $T_A = 25^\circ\text{C}$, $V_{IN} = V_{OUT(nom)} + 1\text{ V}$, $I_{OUT} = 1\text{ mA}$, $C_{IN} = 2\ \mu\text{F}$, $C_{OUT} = 2.0\ \mu\text{F}$, $V_{SD} = 1.5\text{ V}$	Temp ^a	Limits -40 to 85°C			Unit	
				Min ^b	Typ ^c	Max ^b		
Ripple Rejection	$\Delta V_{OUT}/\Delta V_{IN}$	$I_{OUT} = 300\text{ mA}$	f = 1 kHz Room		60		dB	
			f = 10 kHz Room		40			
			f = 100 kHz Room		30			
Dynamic Line Regulation	$\Delta V_{O(line)}$	$V_{IN} : V_{OUT(nom)} + 1\text{ V to } V_{OUT(nom)} + 2\text{ V}$ $t_r/t_f = 2\ \mu\text{s}$, $I_{OUT} = 300\text{ mA}$	Room		20		mV	
Dynamic Load Regulation	$\Delta V_{O(load)}$	$I_{OUT} : 1\text{ mA to } 300\text{ mA}$, $t_r/t_f = 2\ \mu\text{s}$	Room		25			
Thermal Shutdown Junction Temperature	$T_{J(S/D)}$		Room		150		°C	
Thermal Hysteresis	T_{HYST}		Room		20			
Reverse current	I_R	$V_{IN} = -6.0\text{ V}$	Room		1		μA	
Short Circuit Current	I_{SC}	$V_{OUT} = 0\text{ V}$	Room		700		mA	
Shutdown								
Shutdown Supply Current	$I_{CC(off)}$	$V_{SD} = 0\text{ V}$	Room		0.1	1	μA	
$\overline{\text{SD}}$ Pin Input Voltage	V_{SD}	High = Regulator ON (Rising)	Full	1.5		V_{IN}	V	
		Low = Regulator OFF (Falling)	Full			0.4		
Auto Discharge Resistance	R_{DIS}	Si91872 Only	Room		100		Ω	
$\overline{\text{SD}}$ Pin Input Current ^f	$I_{IN(\overline{\text{SD}})}$	$V_{SD} = 1.5\text{ V}$, $V_{IN} = 6\text{ V}$	Room		0.7		μA	
$\overline{\text{SD}}$ Hysteresis	$V_{HYST(\overline{\text{SD}})}$		Full		150		mV	
V_{OUT} Turn-On Time	t_{ON}	V_{SD} (See Figure 1), $I_{LOAD} = 100\text{ mA}$	Room		50		μs	
ERROR Output								
ERROR High Leakage	I_{OFF}	ERROR ≤ V_{IN} , V_{OUT} in Regulation	Full			1	μA	
ERROR Low Voltage	V_{OL}	$I_{SINK} = 0.5\text{ mA}$	Full			0.4	V	
ERROR Voltage Threshold	V_{ERROR}	V_{OUT} Below $V_{OUT(nom)}^g$, $V_{IN} \geq 2\text{ V}$ V_{OUT} Falling, $I_{OUT} = 1\text{ mA}$, $V_{OUT(nom)} \geq 2\text{ V}$	Full	-2	-4	-6	%	
		$V_{OUT(nom)}^g < 2\text{ V}$, $V_{IN} > 2\text{ V}$	Full		-4			
ERROR Voltage Threshold Hysteresis	$V_{HYST(ERROR)}$		Room		1.5			

Notes

- Room = 25°C, Full = -40 to 85°C.
- The algebraic convention whereby the most negative value is a minimum and the most positive a maximum.
- Typical values are for DESIGN AID ONLY, not guaranteed nor subject to production testing.
- Dropout voltage is defined as the input to output differential voltage at which the output voltage drops 2% below the output voltage measured with a 1-V differential, provided that V_{IN} does not drop below 2.0 V.
- Ground current is specified for normal operation as well as “drop-out” operation.
- The device’s shutdown pin includes a typical 2-MΩ internal pull-down resistor connected to ground.
- $V_{OUT(nom)}$ is V_{OUT} when measured with a 1-V differential to V_{IN} .

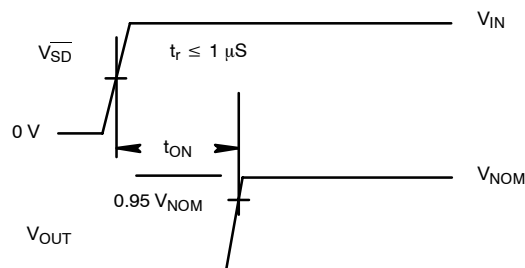
TIMING WAVEFORMS

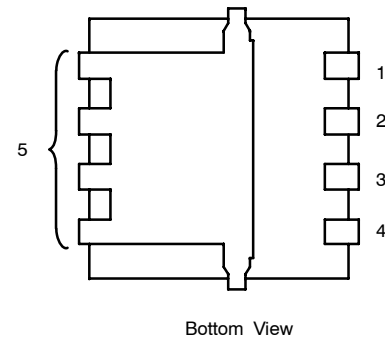
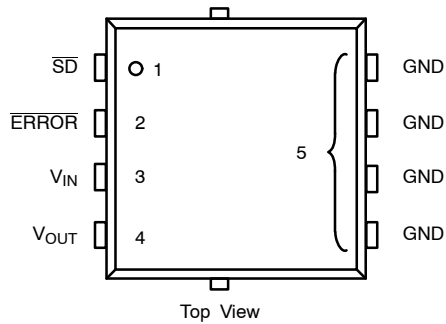
FIGURE 1. Timing Diagram for Power-Up

PIN CONFIGURATION: MLP33-5
MLP33-5 PowerPAK

PIN DESCRIPTION

Pin Number	Name	Function
1	\overline{SD}	By applying less than 0.4 V to this pin, the device will be turned off. Connect this pin to V_{IN} if unused
2	\overline{ERROR}	The open drain output is an error flag output which goes low when V_{OUT} drops 4% below its nominal voltage.
3	V_{IN}	Input supply pin. Bypass this pin with a 1- μ F ceramic or tantalum capacitor to ground
4	V_{OUT}	Output voltage. Connect C_{OUT} between this pin and ground.
5	GND	Ground pin. For better thermal capability, directly connected to large ground plane

ORDERING INFORMATION

Standard Part Number	Lead (Pb)-Free Part Number	Marking	Voltage	Temp. Range	Pkg.
Si91872DMP-12-T1	Si91872DMP-12-E3	7212	1.2	-40 to 85°C	MLP33-5
Si91872DMP-18-T1	Si91872DMP-18-E3	7218	1.8		
Si91872DMP-25-T1	Si91872DMP-25-E3	7225	2.5		
Si91872DMP-26-T1	Si91872DMP-26-E3	7226	2.6		
Si91872DMP-28-T1	Si91872DMP-28-E3	7228	2.8		
Si91872DMP-30-T1	Si91872DMP-30-E3	7230	3.0		
Si91872DMP-33-T1	Si91872DMP-33-E3	7233	3.3		
Si91872DMP-50-T1	Si91872DMP-50-E3	7250	5.0		

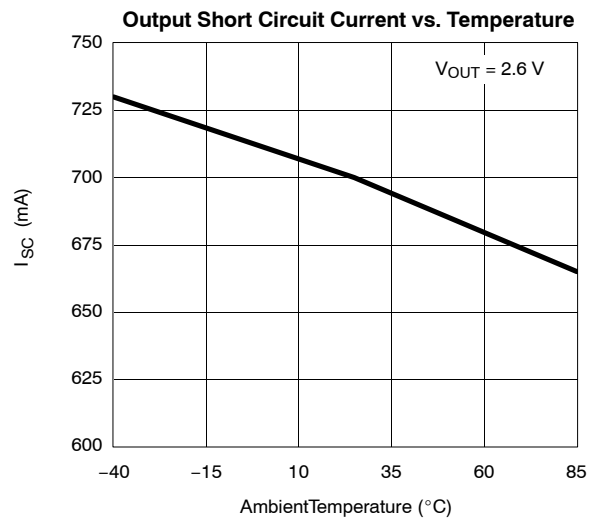
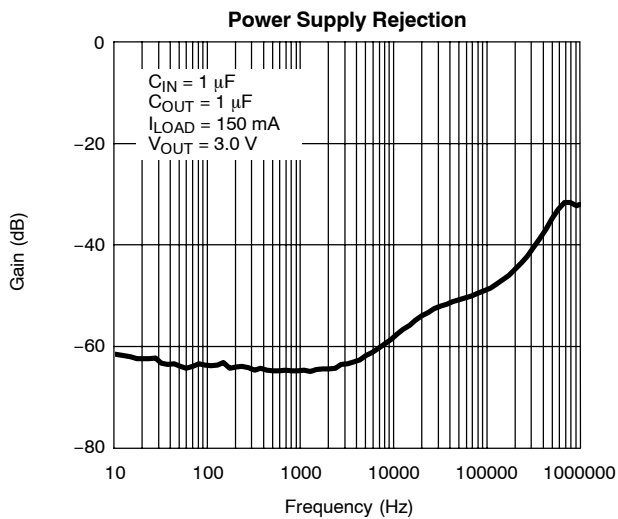
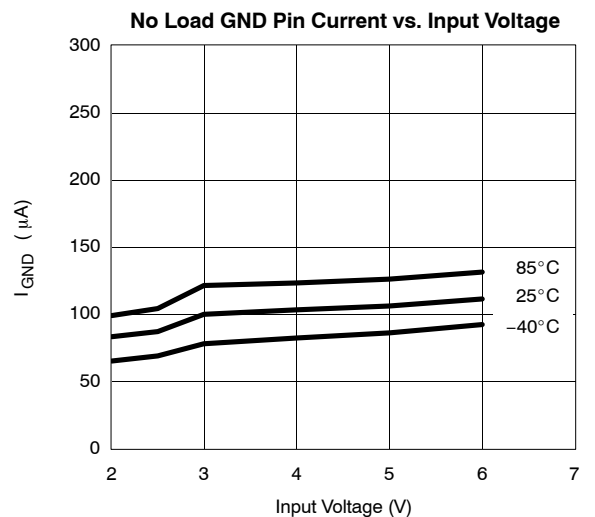
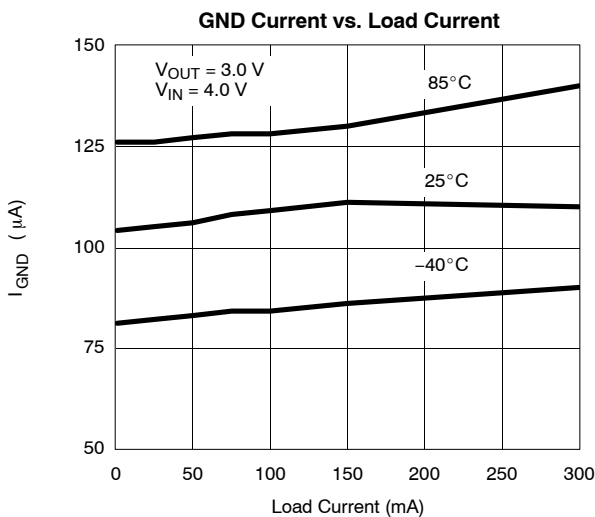
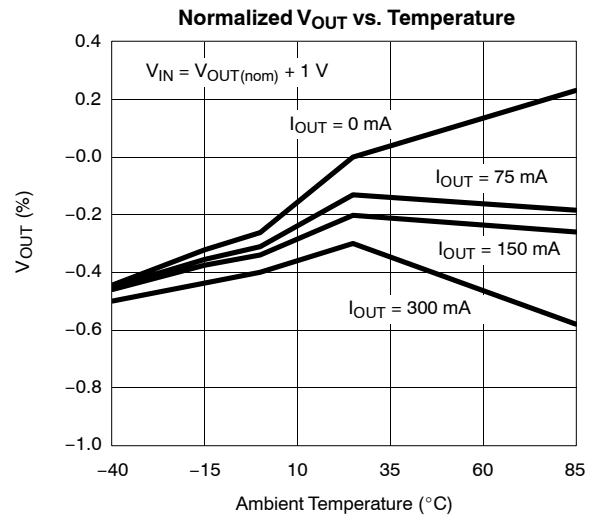
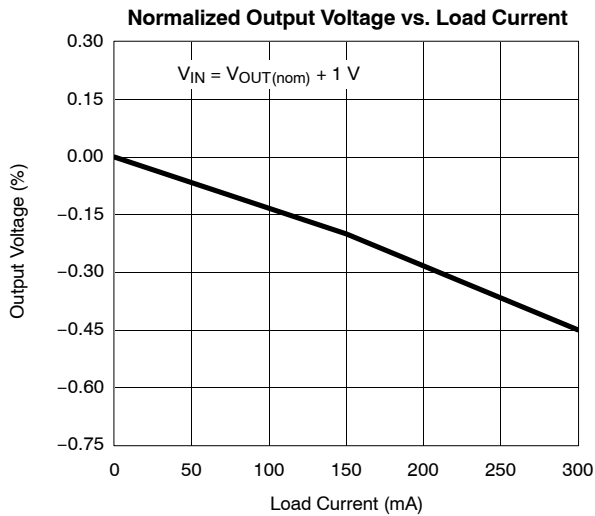
TYPICAL CHARACTERISTICS (INTERNALLY REGULATED, 25°C UNLESS NOTED)



TYPICAL CHARACTERISTICS (INTERNALLY REGULATED, 25°C UNLESS NOTED)

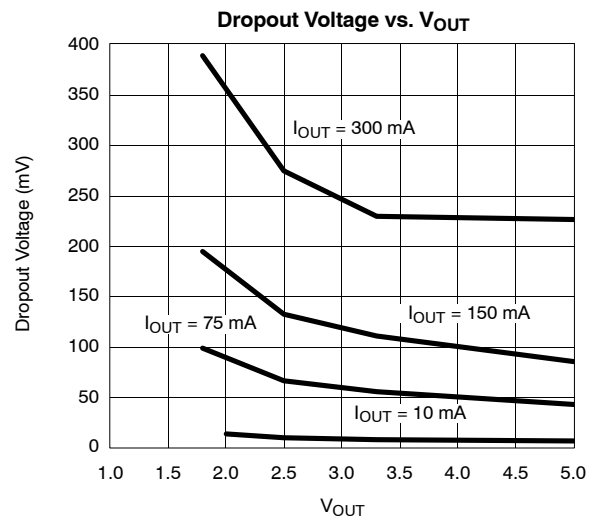
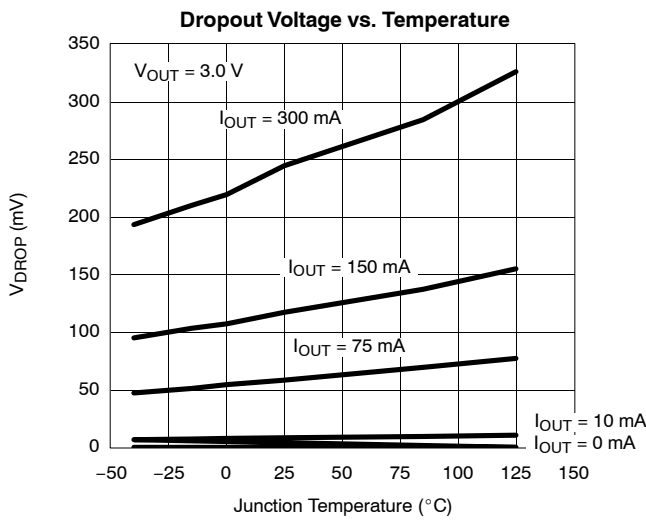
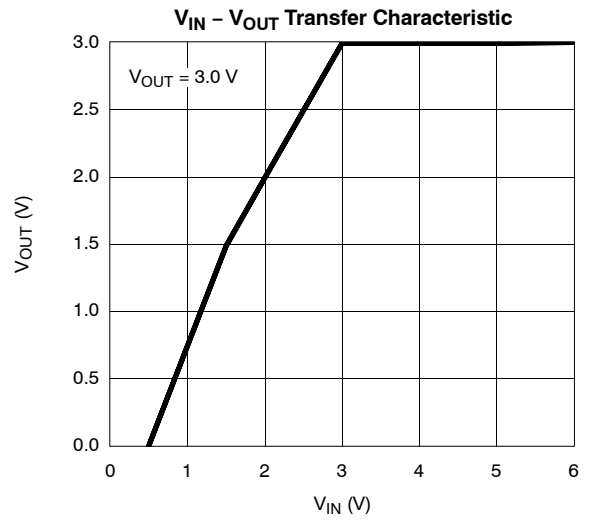
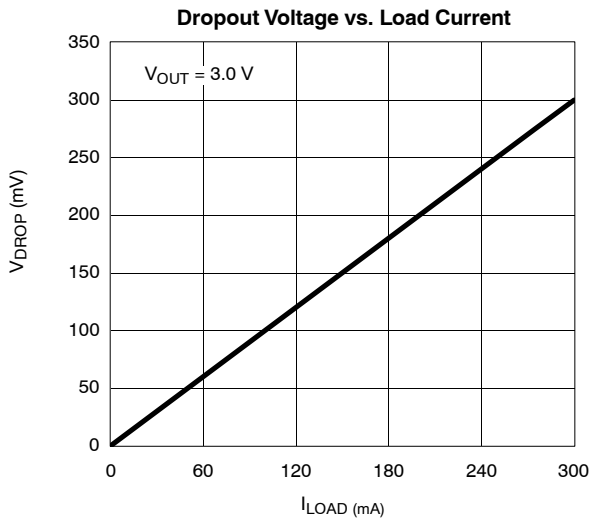

TYPICAL WAVEFORMS

Load Transient Response-1

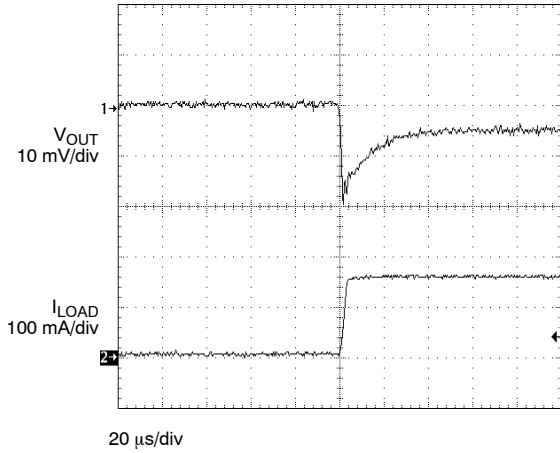

$V_{OUT} = 3.0\text{ V}$
 $C_{OUT} = 1\ \mu\text{F}$
 $I_{LOAD} = 1\ \text{to}\ 150\ \text{mA}$
 $t_{rise} = 2\ \mu\text{sec}$

Load Transient Response-2

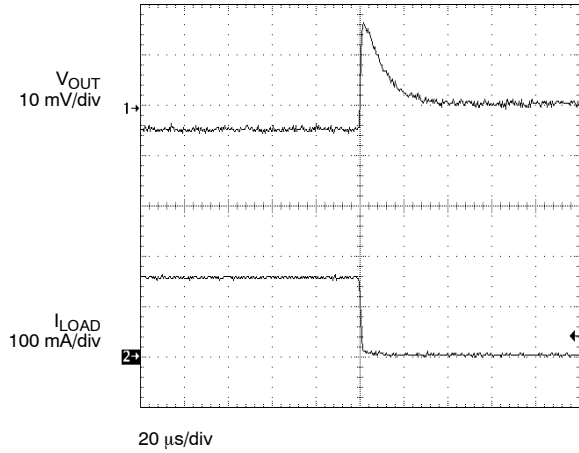

$V_{OUT} = 3.0\text{ V}$
 $C_{OUT} = 1\ \mu\text{F}$
 $I_{LOAD} = 150\ \text{to}\ 1\ \text{mA}$
 $t_{fall} = 2\ \mu\text{sec}$

Line Transient Response-1

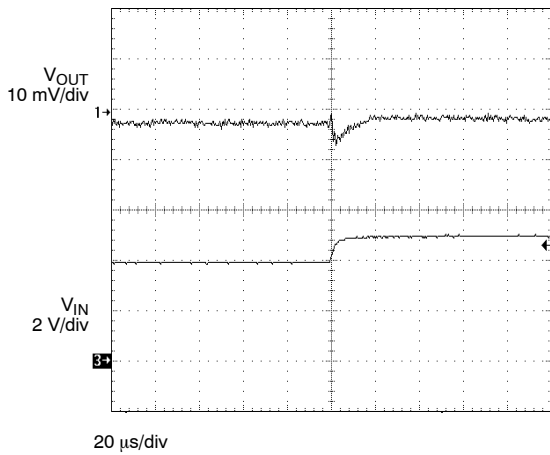

$V_{INSTEP} = 4\ \text{to}\ 5\ \text{V}$
 $V_{OUT} = 3\ \text{V}$
 $C_{OUT} = 1\ \mu\text{F}$
 $C_{IN} = 1\ \mu\text{F}$
 $I_{LOAD} = 150\ \text{mA}$
 $t_{rise} = 5\ \mu\text{sec}$

Line Transient Response-2

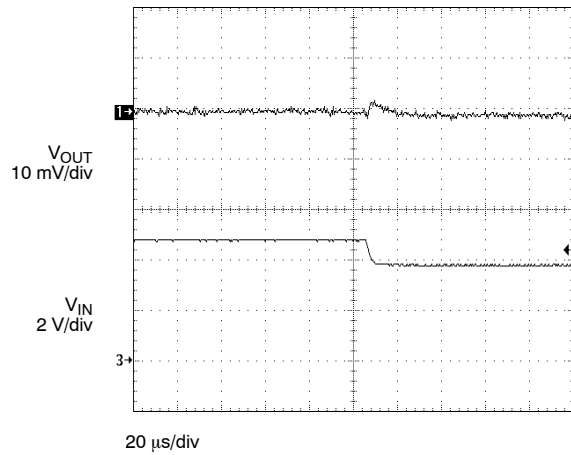

$V_{INSTEP} = 5\ \text{to}\ 4\ \text{V}$
 $V_{OUT} = 3\ \text{V}$
 $C_{OUT} = 1\ \mu\text{F}$
 $C_{IN} = 1\ \mu\text{F}$
 $I_{LOAD} = 150\ \text{mA}$
 $t_{fall} = 5\ \mu\text{sec}$

TYPICAL WAVEFORMS

Output Noise

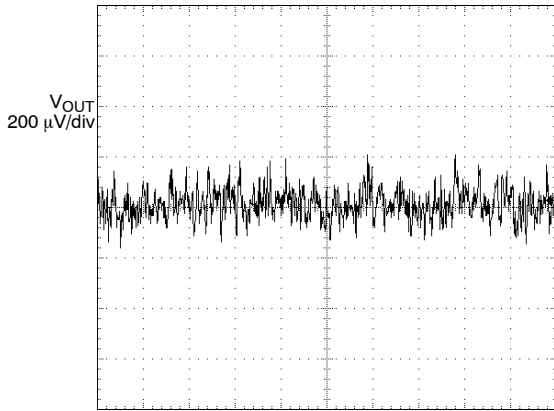

4 ms/div

$V_{IN} = 4\text{ V}$
 $V_{OUT} = 3\text{ V}$
 $I_{OUT} = 150\text{ mA}$
 $BW = 10\text{ Hz to }100\text{ kHz}$

Noise Spectrum

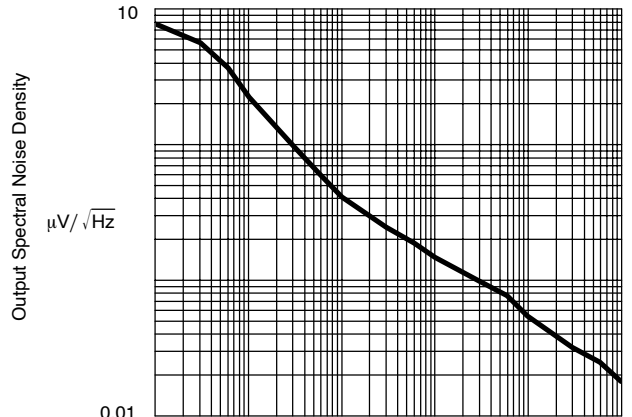

10 Hz

1 MHz

$V_{IN} = 4\text{ V}$
 $V_{OUT} = 3\text{ V}$
 $I_{LOAD} = 150\text{ mA}$

FUNCTIONAL BLOCK DIAGRAM

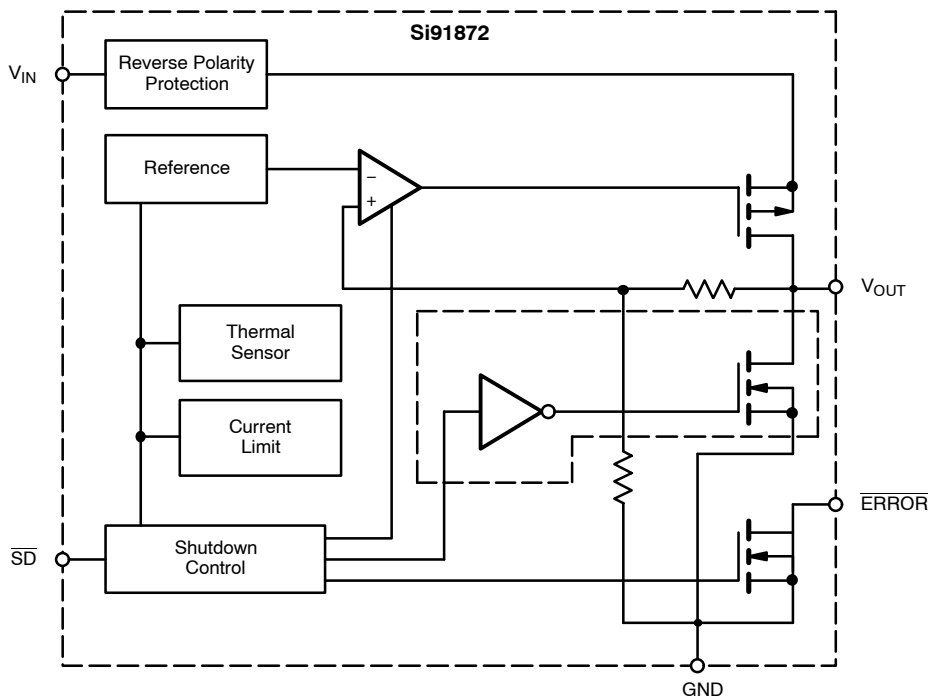

DETAILED DESCRIPTION

The Si91872 is a low-noise, low drop-out and low quiescent current linear voltage regulator, packaged in a small footprint MLP33-5 package. The Si91872 can supply loads up to 300 mA. As shown in the block diagram, the circuit consists of a bandgap reference, error amplifier, p-channel pass transistor and feedback resistor string. Additional blocks, not shown in the block diagram, include a precise current limiter, reverse battery and current protection, and thermal sensor.

Thermal Overload Protection

The thermal overload protection limits the total power dissipation and protects the device from being damaged. When the junction temperature exceeds 150°C, the device turns the p-channel pass transistor off.

Reverse Battery Protection

The Si91872 has a battery reverse protection circuitry that disconnects the internal circuitry when V_{IN} drops below the GND voltage. There is no current drawn in such an event. When the \overline{SD} pin is hardwired to V_{IN} , the user must connect the \overline{SD} pin to V_{IN} via a 100-k Ω resistor if reverse battery protection is desired. Hardwiring the \overline{SD} pin directly to the V_{IN} pin is allowed when reverse battery protection is not desired.

ERROR

\overline{ERROR} is an open drain output that goes low when V_{OUT} is less than 4% of its normal value. To obtain a logic level output, connect a pull-up resistor from \overline{ERROR} to V_{OUT} or any other voltage equal to or less than V_{IN} . \overline{ERROR} pin is high impedance (off) when \overline{SD} pin is low.

Auto-Discharge

V_{OUT} has an internal 100- Ω (typ.) discharge path to ground when \overline{SD} pin is low for the Si91872.

Stability

The circuit is stable with only a small output capacitor equal to 6 nF/mA (= 2 μ F @ 300 mA). Since the bandwidth of the error amplifier is around 1–3 MHz and the dominant pole is at the output node, the capacitor should be capacitive in this range, i.e., for 150-mA load current, an ESR <0.2 Ω is necessary. Parasitic inductance of about 10 nH can be tolerated.

Safe Operating Area

The ability of the Si91872 to supply current is ultimately dependent on the junction temperature of the pass device. Junction temperature is in turn dependent on power dissipation in the pass device, the thermal resistance of the

package and the circuit board, and the ambient temperature. The power dissipation is defined as

$$P_D = (V_{IN} - V_{OUT}) * I_{OUT}$$

Junction temperature is defined as

$$T_J = T_A + ((P_D * (R_{\theta_{JC}} + R_{\theta_{CA}}))$$

To calculate the limits of performance, these equations must be rewritten.

Allowable power dissipation is calculated using the equation

$$P_D = (T_J - T_A) / (R_{\theta_{JC}} + R_{\theta_{CA}})$$

While allowable output current is calculated using the equation

$$I_{OUT} = (T_J - T_A) / (R_{\theta_{JC}} + R_{\theta_{CA}}) * (V_{IN} - V_{OUT})$$

Ratings of the Si91872 that must be observed are

$$T_{Jmax} = 125\text{ }^\circ\text{C}, T_{Amax} = 85\text{ }^\circ\text{C}, (V_{IN} - V_{OUT})_{max} = 5.3\text{ V}, R_{\theta_{JC}} = 8\text{ }^\circ\text{C/W}$$

The value of $R_{\theta_{CA}}$ is dependent on the PC board used. The value of $R_{\theta_{CA}}$ for the board used in device characterization is approximately 46 $^\circ\text{C/W}$.

Figure 1 shows the performance limits graphically for the Si91872 mounted on the circuit board used for thermal characterization.

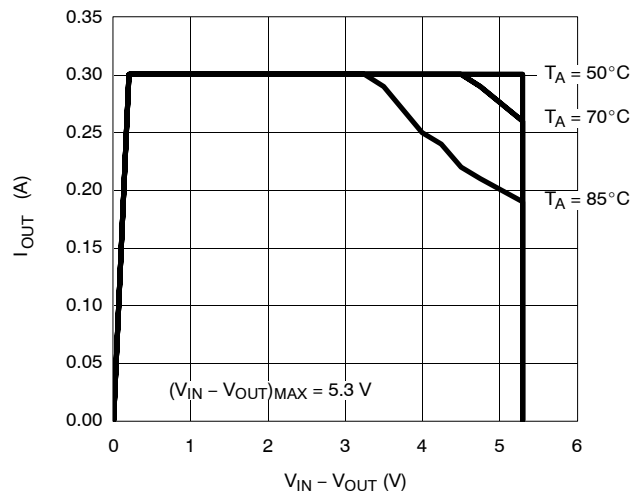

Figure 1. Safe Operating Area

Vishay Siliconix maintains worldwide manufacturing capability. Products may be manufactured at one of several qualified locations. Reliability data for Silicon Technology and Package Reliability represent a composite of all qualified locations. For related documents such as package/tape drawings, part marking, and reliability data, see <http://www.vishay.com/ppg?72013>.



Disclaimer

All product specifications and data are subject to change without notice.

Vishay Intertechnology, Inc., its affiliates, agents, and employees, and all persons acting on its or their behalf (collectively, "Vishay"), disclaim any and all liability for any errors, inaccuracies or incompleteness contained herein or in any other disclosure relating to any product.

Vishay disclaims any and all liability arising out of the use or application of any product described herein or of any information provided herein to the maximum extent permitted by law. The product specifications do not expand or otherwise modify Vishay's terms and conditions of purchase, including but not limited to the warranty expressed therein, which apply to these products.

No license, express or implied, by estoppel or otherwise, to any intellectual property rights is granted by this document or by any conduct of Vishay.

The products shown herein are not designed for use in medical, life-saving, or life-sustaining applications unless otherwise expressly indicated. Customers using or selling Vishay products not expressly indicated for use in such applications do so entirely at their own risk and agree to fully indemnify Vishay for any damages arising or resulting from such use or sale. Please contact authorized Vishay personnel to obtain written terms and conditions regarding products designed for such applications.

Product names and markings noted herein may be trademarks of their respective owners.

Looking for pricing, stock, or lifecycle information?

Click below to explore more details on WIN SOURCE:

 [View S191872DMP-50-E3 on WIN SOURCE](#)

 [Vishay Information](#)

Optimize Your Supply Chain with WIN SOURCE Solutions

-  Global Sourcing Solution
-  Obsolete Management
-  Cost Control Management
-  Shortage Management
-  Alternative Solution
-  Excess Inventory Management