



# THE DATASHEET OF ST1L04PT



## Low quiescent current voltage regulator

Datasheet - production data

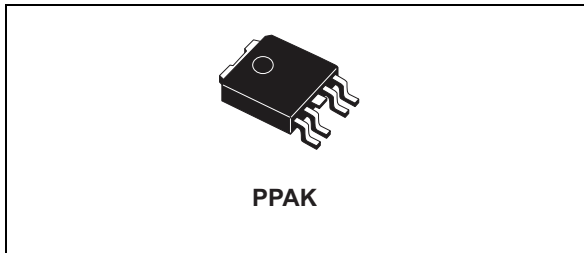

### Description

The ST1L04 is a low drop adjustable linear voltage regulator, which supplies up to 1 A output current. The output voltage can be as low as 0.8 V. The quiescent current is controlled and maintained well below 3 mA over the whole allowed junction temperature range. The ST1L04 is stable with low ESR output ceramic capacitors only. Internal protection circuitry includes thermal protection with hysteresis and overcurrent limiting. The ST1L04 is especially suitable for applications requiring low voltage outputs from low voltage inputs. Typical applications for this product are: notebook PCs, low voltage ASIC, VID power supplies and low cost post regulation for 3.3 V output voltage switching regulators.

### Features

- Adjustable output voltage from 0.8 V to  $V_I - V_D$
- Internal reference voltage
- Accuracy  $\pm 2\%$  at 25 °C
- Output current capability: 1 A minimum
- Very low quiescent current: max. 3 mA over the whole temperature range
- Maximum dropout 1 V @  $I_O = 1$  A
- Stable with low ESR ceramic capacitors only
- Thermal shutdown protection with hysteresis
- Overcurrent protection
- Operating junction temperature range: from 0 to 125 °C

Table 1. Device summary

Order code	Package
ST1L04PT	PPAK

Figure 1. Schematic diagram

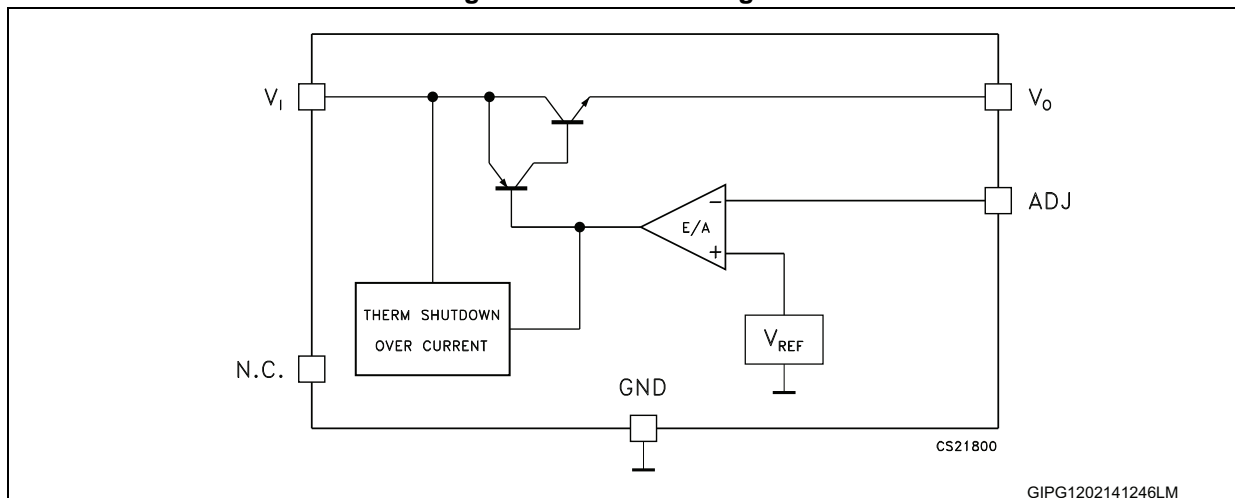

---

## Contents

1	Pin description .....	3
2	Maximum ratings .....	4
3	Electrical characteristics .....	5
4	Typical characteristics .....	6
5	ECOPACK® .....	10
6	Packaging mechanical data .....	13
7	Revision history .....	16

# 1 Pin description

Figure 2. Pin connection (top view)

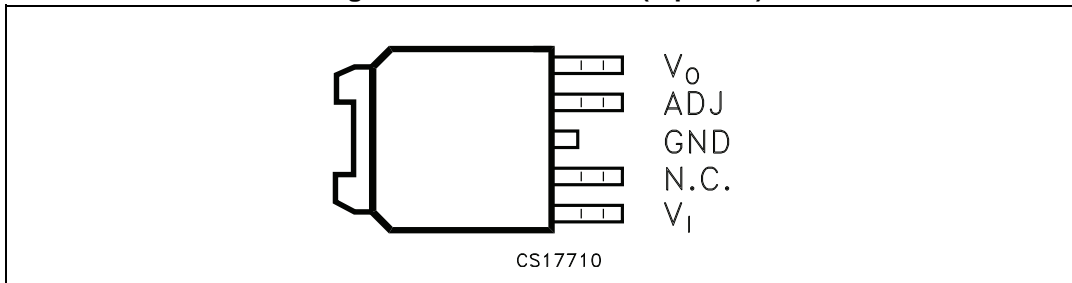
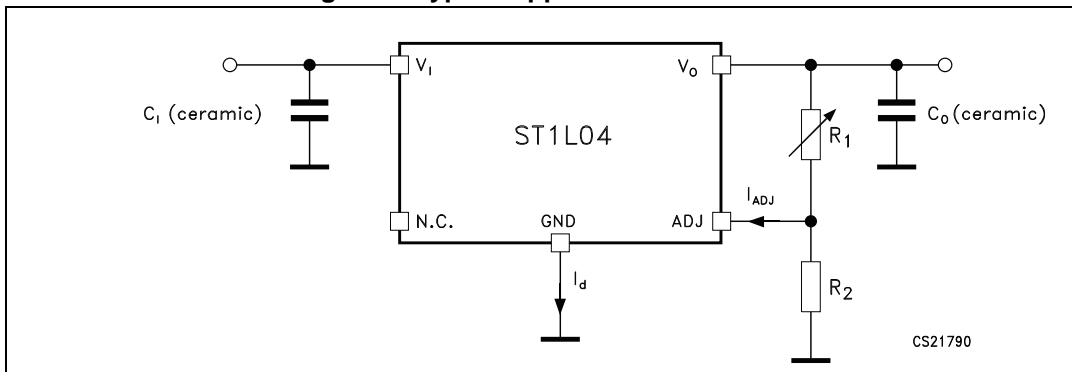

Table 2. Pin description

Pin	Name	Function
1	V <sub>I</sub>	Supply voltage input pin. Bypass with a ceramic capacitor to GND
2	N.C.	Not connected
3	GND	Ground. The exposed metallic pad of the package is connected to GND
4	ADJ	Adjust voltage pin. External resistor divider connection
5	V <sub>O</sub>	Output voltage pin. Bypass with a ceramic capacitor to GND

Figure 3. Typical application schematic



The adjustable output voltage is set by a resistor divider connected between V<sub>O</sub> and GND with its centre tap connected to ADJ. The voltage divider resistors are: R<sub>1</sub> connected between V<sub>O</sub> and ADJ and R<sub>2</sub> connected between ADJ and GND. V<sub>O</sub> is given by V<sub>REF</sub>, R<sub>1</sub>, R<sub>2</sub>, I<sub>ADJ</sub>, as follows:

$$V_O = V_{REF}(1 + R_1/R_2) + I_{ADJ}R_1$$

since I<sub>ADJ</sub> is very small and stable, it can be ignored and the output voltage can be simply calculated as follows:

$$V_O = V_{REF}(1 + R_1/R_2)$$

## 2 Maximum ratings

**Table 3. Absolute maximum ratings**

Symbol	Parameter	Value	Unit
$V_I$	DC supply voltage	From GND -0.3 to 10	V
$P_{TOT}$	Power dissipation	Internally limited	W
$I_O$	Output current	Internally limited	A
$T_{OP}$	Operating junction temperature range	0 to + 125	°C
$T_{STG}$	Storage temperature range	-40 to +150	°C

*Note: Absolute maximum ratings are those values beyond which damage to the device may occur. Functional operation under these conditions is not implied.*

**Table 4. Thermal data**

Symbol	Parameter	PPAK	Unit
$R_{thj-case}$	Thermal resistance junction-case	8	°C/W
$R_{thj-amb}$	Thermal resistance junction-ambient	100	°C/W

### 3 Electrical characteristics

Refer to the typical application schematic,  $V_{IN}$  from 2.9 to 5.5 V,  $I_O$  from 10 mA to 1 A,  $C_{IN} = 4.7 \mu\text{F}$ ,  $C_{OUT} = 4.7 \mu\text{F}$ ,  $T_J = 0$  to  $125 \text{ }^\circ\text{C}$ , unless otherwise specified.  $T_J = 25 \text{ }^\circ\text{C}$  unless otherwise specified.

**Table 5. Electrical characteristics**

Symbol	Parameter	Test conditions	Min.	Typ.	Max.	Unit
$V_I$	Operating input voltage		2.8			V
$I_d$	Quiescent current				3	mA
$V_{REF}$	Reference voltage	$T_J = 25 \text{ }^\circ\text{C}$	0.784	0.8	0.816	V
			0.776	0.8	0.824	
$\Delta V_O$	Line regulation	$I_O = 10 \text{ mA}$			0.8	%
	Load regulation	$V_I = 3.3 \text{ V}$			0.8	%
$I_{ADJ}$	Adjustment current	$I_O = 10 \text{ mA}$			1	$\mu\text{A}$
$I_{\Delta ADJ}$	Adjustment current change				200	nA
$I_{Omin}$	Minimum output current for regulation				100	$\mu\text{A}$
$I_O$	Output current limit		1		1.4	A
$V_d$	Dropout voltage <sup>(1) (2)</sup>	$I_O = 1 \text{ A}$ , $V_O = \text{from } 1.8 \text{ to } 3.3 \text{ V}$			1	V
SVR	Supply voltage rejection <sup>(2)</sup>	$V_I = 3.3 \pm 0.5 \text{ V}$ , $I_O = 10 \text{ mA}$ , $T_J = 25 \text{ }^\circ\text{C}$	$f = 120 \text{ Hz}$	50		dB
			$f = 100 \text{ kHz}$	20		
$C_O$	Ceramic output capacitor value		2.2			$\mu\text{F}$
$C_{ESR}$	Output capacitor ESR value				200	m $\Omega$
eN	Output noise voltage <sup>(2)</sup>	$B = \text{from } 10 \text{ Hz to } 10 \text{ kHz}$ , $V_I = 3.3 \text{ V}$ , $I_O = 10 \text{ mA}$ , $T_J = 25 \text{ }^\circ\text{C}$		0.003		% $V_O$
$T_{SH}$	Thermal shutdown trip point <sup>(2)</sup>	$V_I = 3.3 \text{ V}$		165		$^\circ\text{C}$
$T_{HY}$	Thermal shutdown hysteresis <sup>(2)</sup>	$V_I = 3.3 \text{ V}$		5		$^\circ\text{C}$

1. This parameter is the minimum input-to-output differential voltage required to maintain 1% regulation with respect to the  $V_O$  nominal value. As to  $V_O$  between 0.8 V and 1.8 V included, the  $V_d$  value is overridden by the minimum operating input voltage.

2. Guaranteed by design. Not tested in production.

# 4 Typical characteristics

**Figure 4. Output voltage vs. temperature**  
 $V_I = 2.9\text{ V}$

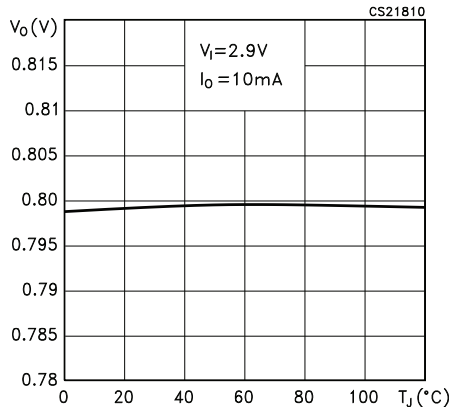

**Figure 5. Load regulation vs. temperature**

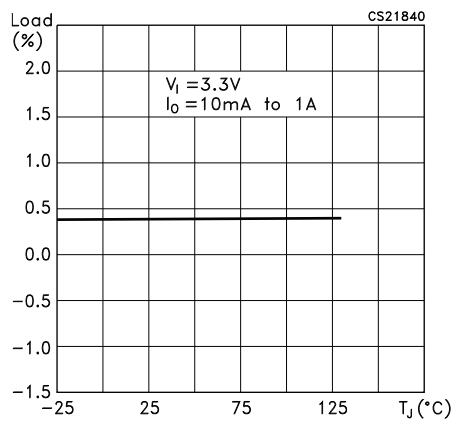

**Figure 6. Output voltage vs. temperature**  
 $V_I = 3.3\text{ V}$

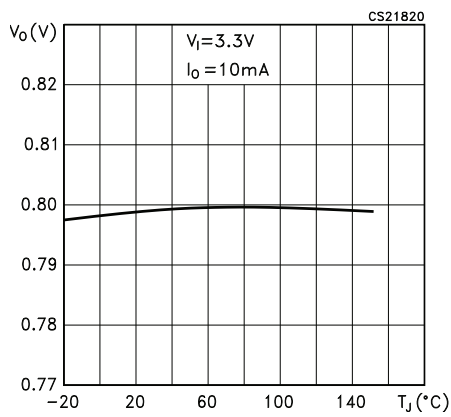

**Figure 7. Quiescent current vs. temperature**  
 $I_O = 1\text{ A}$

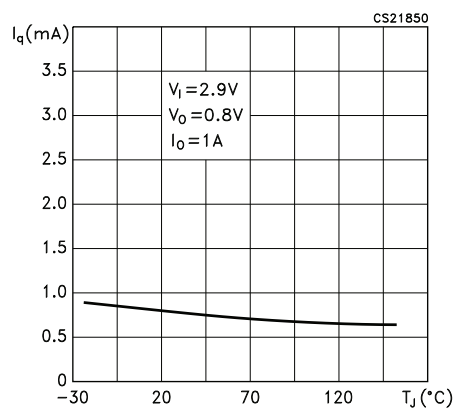

Figure 8. Line regulation vs. temperature

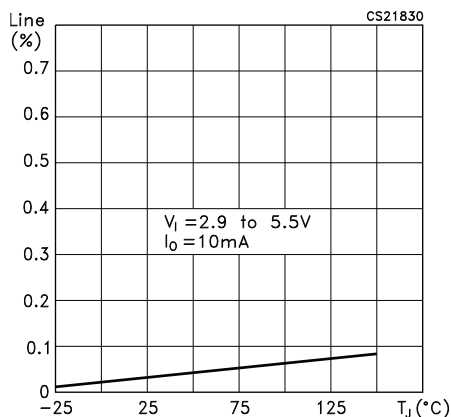

Figure 9. Quiescent current vs. temperature  
 $I_O = 10\text{ mA}$

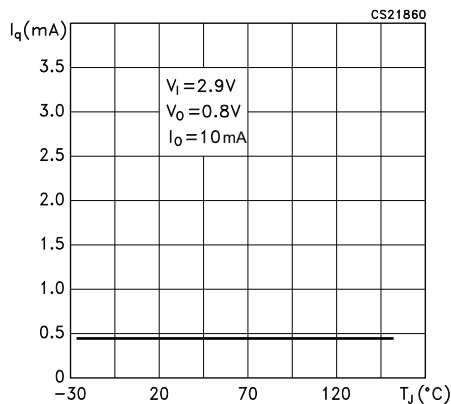

Figure 10. Quiescent current vs. output current

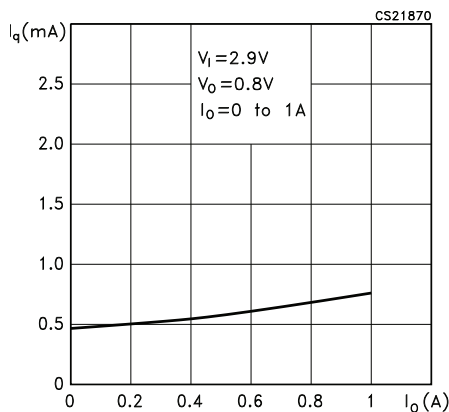

Figure 11. Dropout voltage vs. output current

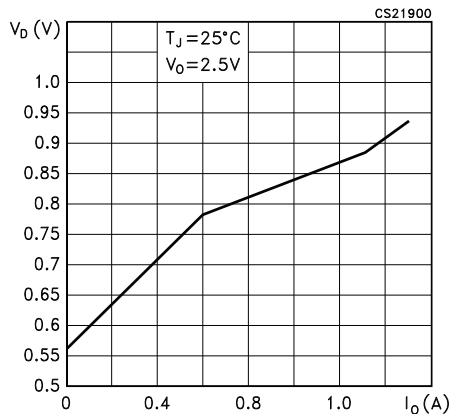

Figure 12. Quiescent current vs. input voltage

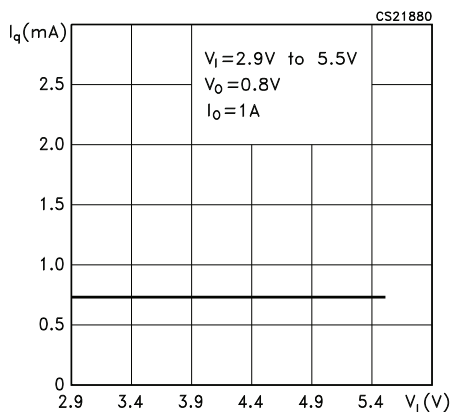

Figure 13. Supply ripple rejection vs. temperature  
 $f = 100\text{ kHz}$

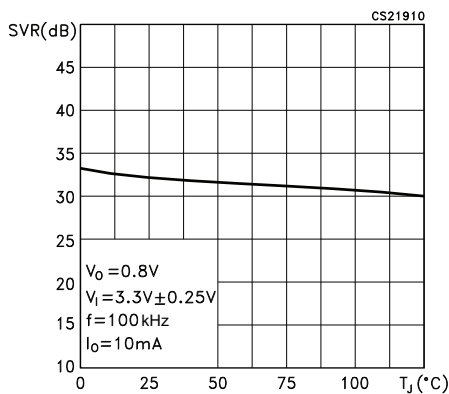

Figure 14. Dropout voltage vs. temperature

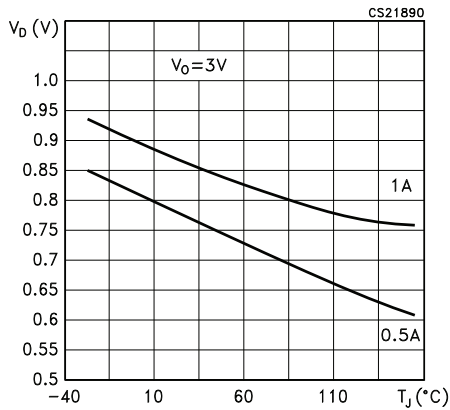

Figure 15. Supply ripple rejection vs. temperature  $f=102$  Hz

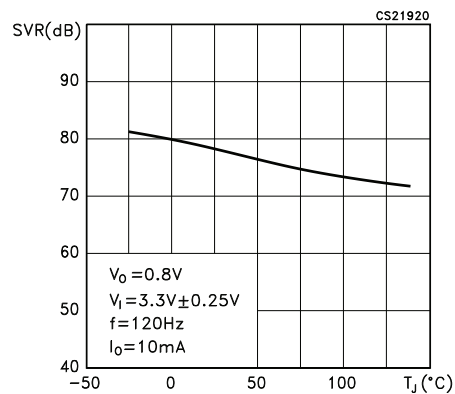

Figure 16. Supply ripple rejection vs. output current

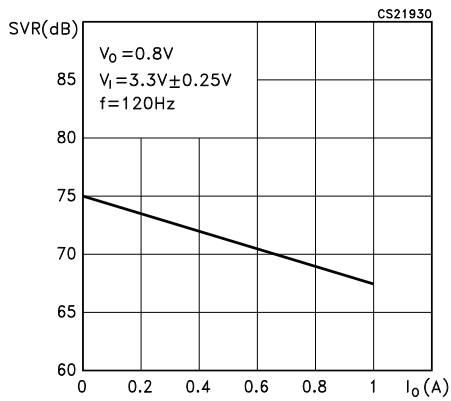

Figure 17. Adjustment current change vs. temperature

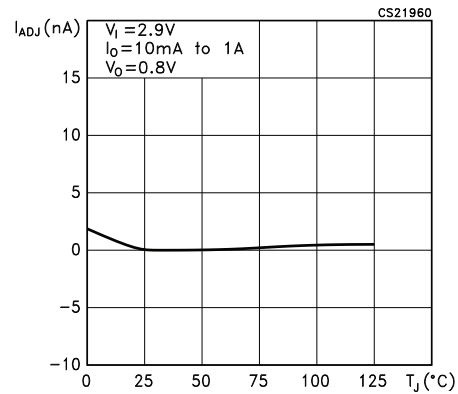

Figure 18. Supply ripple rejection vs. frequency

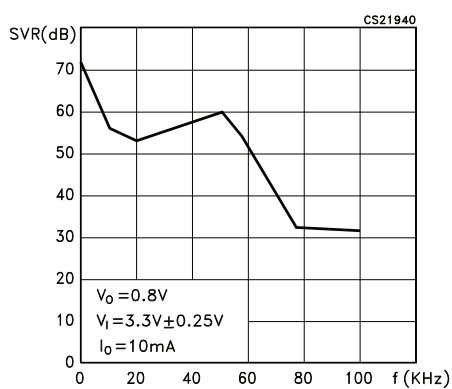

Figure 19. Minimum output current for regulation vs. temperature  $V_I = 5.5$  V

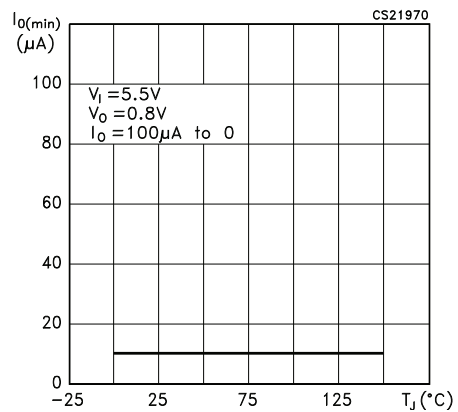

Figure 20. Adjustment current vs. temperature

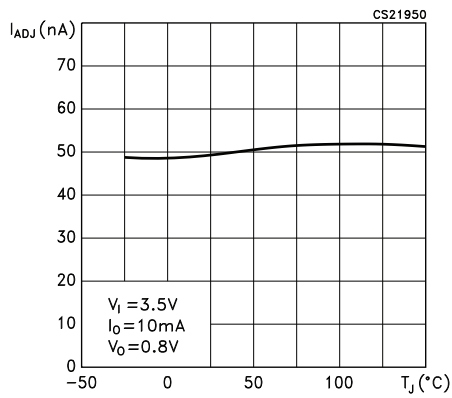

Figure 21. Minimum output current for regulation vs. temperature  $V_I = 2.6V$

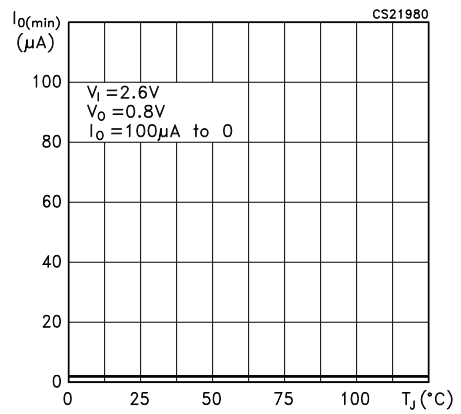

Figure 22. Load transient

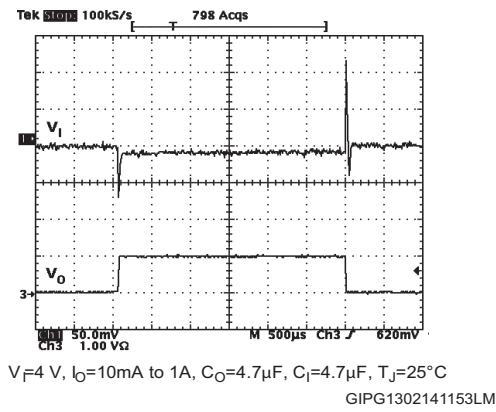
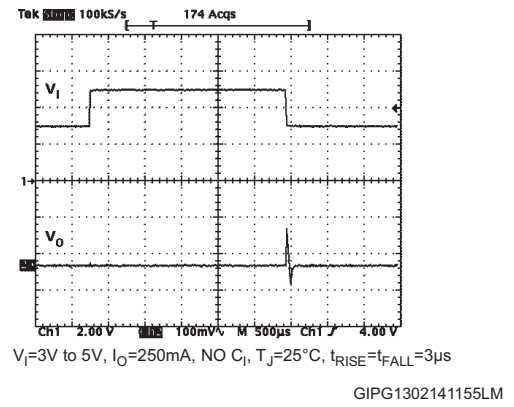

Figure 23. Line transient



## 5 ECOPACK®

In order to meet environmental requirements, ST offers these devices in different grades of ECOPACK® packages, depending on their level of environmental compliance. ECOPACK® specifications, grade definitions and product status are available at: [www.st.com](http://www.st.com). ECOPACK® is an ST trademark.

Figure 24. PPAK drawings

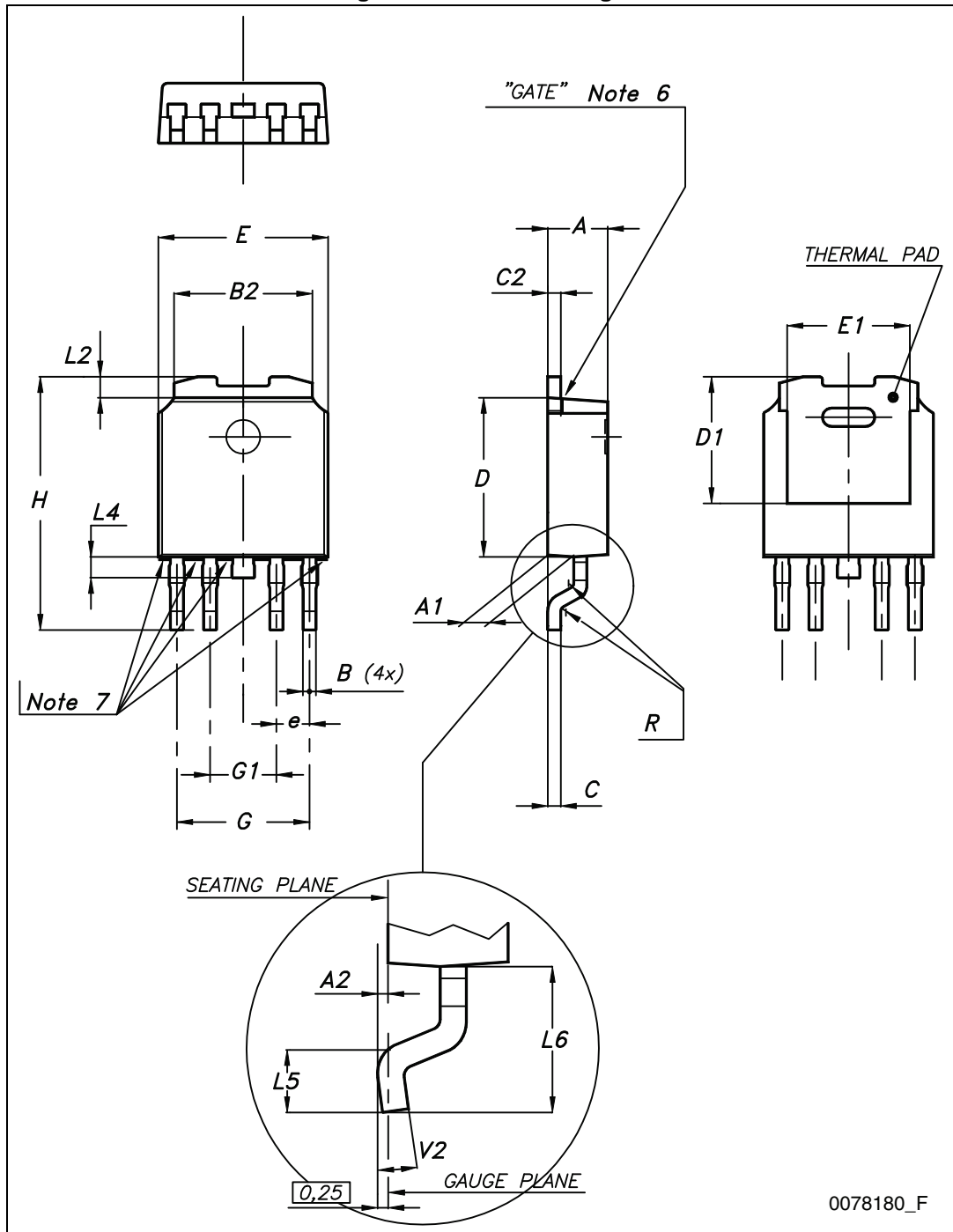

0078180\_F

Table 6. PPAK mechanical data

Dim.	mm		
	Min.	Typ.	Max.
A	2.2		2.4
A1	0.9		1.1
A2	0.03		0.23
B	0.4		0.6
B2	5.2		5.4
C	0.45		0.6
C2	0.48		0.6
D	6		6.2
D1		5.1	
E	6.4		6.6
E1		4.7	
e		1.27	
G	4.9		5.25
G1	2.38		2.7
H	9.35		10.1
L2		0.8	1
L4	0.6		1
L5	1		
L6		2.8	
R		0.20	
V2	0°		8°

# 6 Packaging mechanical data

Figure 25. Tape for PPAK

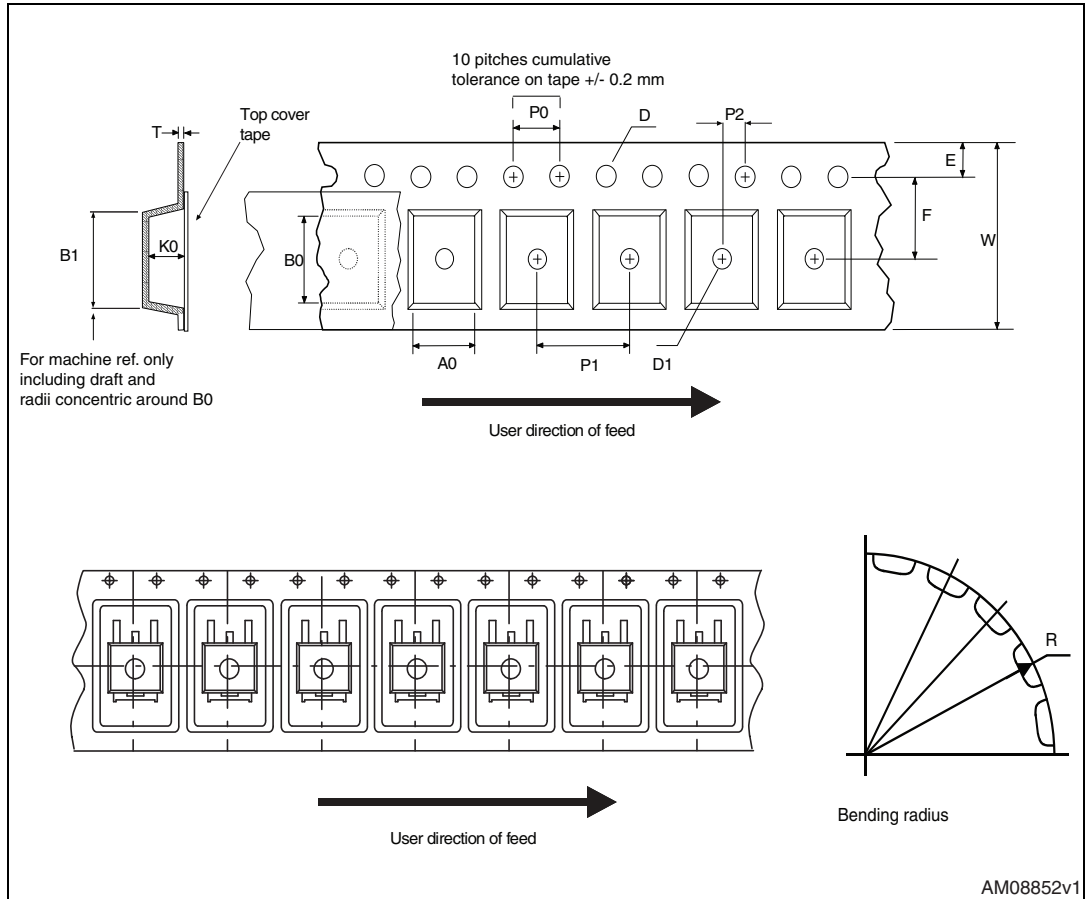

Figure 26. Reel for PPAK

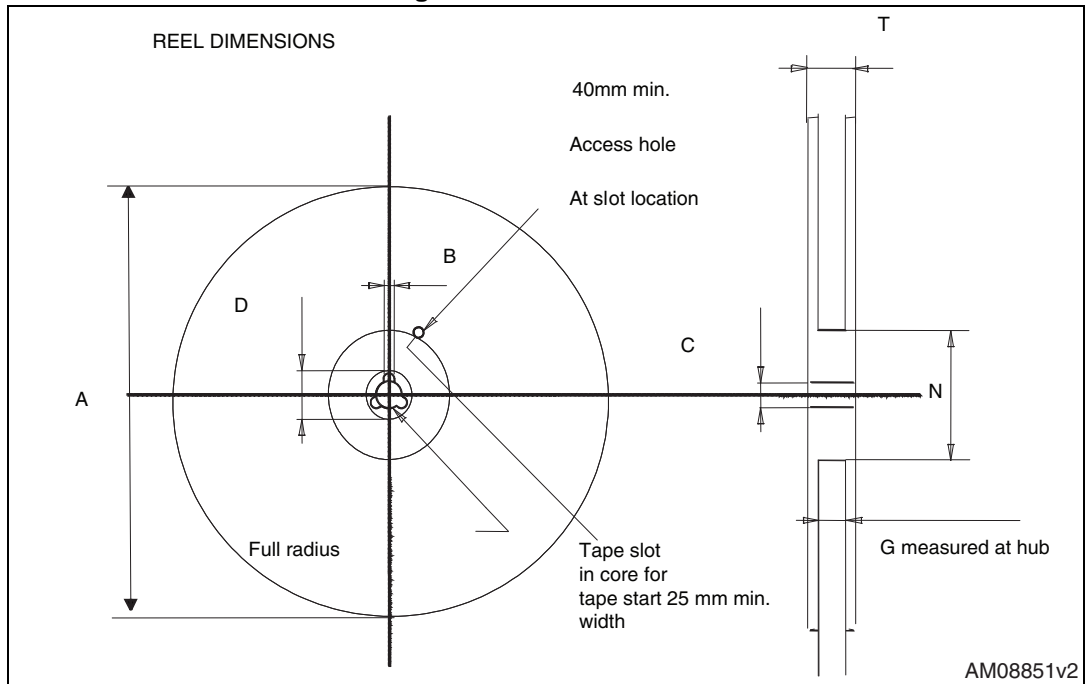

Table 7. PPAK tape and reel mechanical data

Tape			Reel		
Dim.	mm		Dim.	mm	
	Min.	Max.		Min.	Max.
A0	6.8	7	A		330
B0	10.4	10.6	B	1.5	
B1		12.1	C	12.8	13.2
D	1.5	1.6	D	20.2	
D1	1.5		G	16.4	18.4
E	1.65	1.85	N	50	
F	7.4	7.6	T		22.4
K0	2.55	2.75			
P0	3.9	4.1	Base quantity		2500
P1	7.9	8.1	Bulk quantity		2500
P2	1.9	2.1			
R	40				
T	0.25	0.35			
W	15.7	16.3			

## 7 Revision history

Table 8. Document revision history

Date	Revision	Changes
10-Feb-2005	1	Initial release.
05-Mar-2014	2	Updated <i>Features</i> . Updated <i>Table 5</i> . Changed title of <i>Figure 4</i> , <i>Figure 6</i> , <i>Figure 7</i> , <i>Figure 15</i> , <i>Figure 19</i> and <i>Figure 21</i> . Updated <i>Figure 9</i> and <i>Figure 13</i> . Minor text changes.

**Please Read Carefully:**

Information in this document is provided solely in connection with ST products. STMicroelectronics NV and its subsidiaries ("ST") reserve the right to make changes, corrections, modifications or improvements, to this document, and the products and services described herein at any time, without notice.

All ST products are sold pursuant to ST's terms and conditions of sale.

Purchasers are solely responsible for the choice, selection and use of the ST products and services described herein, and ST assumes no liability whatsoever relating to the choice, selection or use of the ST products and services described herein.

No license, express or implied, by estoppel or otherwise, to any intellectual property rights is granted under this document. If any part of this document refers to any third party products or services it shall not be deemed a license grant by ST for the use of such third party products or services, or any intellectual property contained therein or considered as a warranty covering the use in any manner whatsoever of such third party products or services or any intellectual property contained therein.

**UNLESS OTHERWISE SET FORTH IN ST'S TERMS AND CONDITIONS OF SALE ST DISCLAIMS ANY EXPRESS OR IMPLIED WARRANTY WITH RESPECT TO THE USE AND/OR SALE OF ST PRODUCTS INCLUDING WITHOUT LIMITATION IMPLIED WARRANTIES OF MERCHANTABILITY, FITNESS FOR A PARTICULAR PURPOSE (AND THEIR EQUIVALENTS UNDER THE LAWS OF ANY JURISDICTION), OR INFRINGEMENT OF ANY PATENT, COPYRIGHT OR OTHER INTELLECTUAL PROPERTY RIGHT.**

**ST PRODUCTS ARE NOT DESIGNED OR AUTHORIZED FOR USE IN: (A) SAFETY CRITICAL APPLICATIONS SUCH AS LIFE SUPPORTING, ACTIVE IMPLANTED DEVICES OR SYSTEMS WITH PRODUCT FUNCTIONAL SAFETY REQUIREMENTS; (B) AERONAUTIC APPLICATIONS; (C) AUTOMOTIVE APPLICATIONS OR ENVIRONMENTS, AND/OR (D) AEROSPACE APPLICATIONS OR ENVIRONMENTS. WHERE ST PRODUCTS ARE NOT DESIGNED FOR SUCH USE, THE PURCHASER SHALL USE PRODUCTS AT PURCHASER'S SOLE RISK, EVEN IF ST HAS BEEN INFORMED IN WRITING OF SUCH USAGE, UNLESS A PRODUCT IS EXPRESSLY DESIGNATED BY ST AS BEING INTENDED FOR "AUTOMOTIVE, AUTOMOTIVE SAFETY OR MEDICAL" INDUSTRY DOMAINS ACCORDING TO ST PRODUCT DESIGN SPECIFICATIONS. PRODUCTS FORMALLY ESCC, QML OR JAN QUALIFIED ARE DEEMED SUITABLE FOR USE IN AEROSPACE BY THE CORRESPONDING GOVERNMENTAL AGENCY.**

Resale of ST products with provisions different from the statements and/or technical features set forth in this document shall immediately void any warranty granted by ST for the ST product or service described herein and shall not create or extend in any manner whatsoever, any liability of ST.

ST and the ST logo are trademarks or registered trademarks of ST in various countries.

Information in this document supersedes and replaces all information previously supplied.

The ST logo is a registered trademark of STMicroelectronics. All other names are the property of their respective owners.

© 2014 STMicroelectronics - All rights reserved

STMicroelectronics group of companies



Australia - Belgium - Brazil - Canada - China - Czech Republic - Finland - France - Germany - Hong Kong - India - Israel - Italy - Japan - Malaysia - Malta - Morocco - Philippines - Singapore - Spain - Sweden - Switzerland - United Kingdom - United States of America

[www.st.com](http://www.st.com)





## Looking for pricing, stock, or lifecycle information?

Click below to explore more details on WIN SOURCE:

-  [View ST1L04PT on WIN SOURCE](#)
-  [STMicroelectronics Information](#)

## Optimize Your Supply Chain with WIN SOURCE Solutions

-  Global Sourcing Solution
-  Obsolete Management
-  Cost Control Management
-  Shortage Management
-  Alternative Solution
-  Excess Inventory Management