



**THE DATASHEET OF  
SG7908T**



## Negative Fixed Voltage Regulator

### DESCRIPTION

The SG79xxA/SG79xx series of negative regulators offer self-contained, fixed-voltage capability with up to 1.5A of load current and input voltage up to -30V. With a variety of output voltages this regulator series is an optimum complement to the SG7800A/SG7800 positive three terminal regulators.

These units feature a unique band gap reference which allows the SG79xxA series to be specified with an output voltage tolerance of  $\pm 1.5\%$ .

The SG79xxA versions also offer much improved line regulation characteristics. All protective features of thermal shutdown, current limiting, and safe-area

control have been designed into these units and since these regulators require only a single output capacitor (SG79xx series) or a capacitor and 5mA minimum load (SG120 series) for satisfactory performance, ease of application is assured.

Although designed as fixed-voltage regulators, the output voltage can be increased through the use of a simple voltage divider. The low quiescent drain current of the device insures good regulation when this method is used.

These devices are available in hermetically sealed TO-257 (both case grounded 'G' and isolated 'IG'), TO-3, TO-39, and LCC packages.

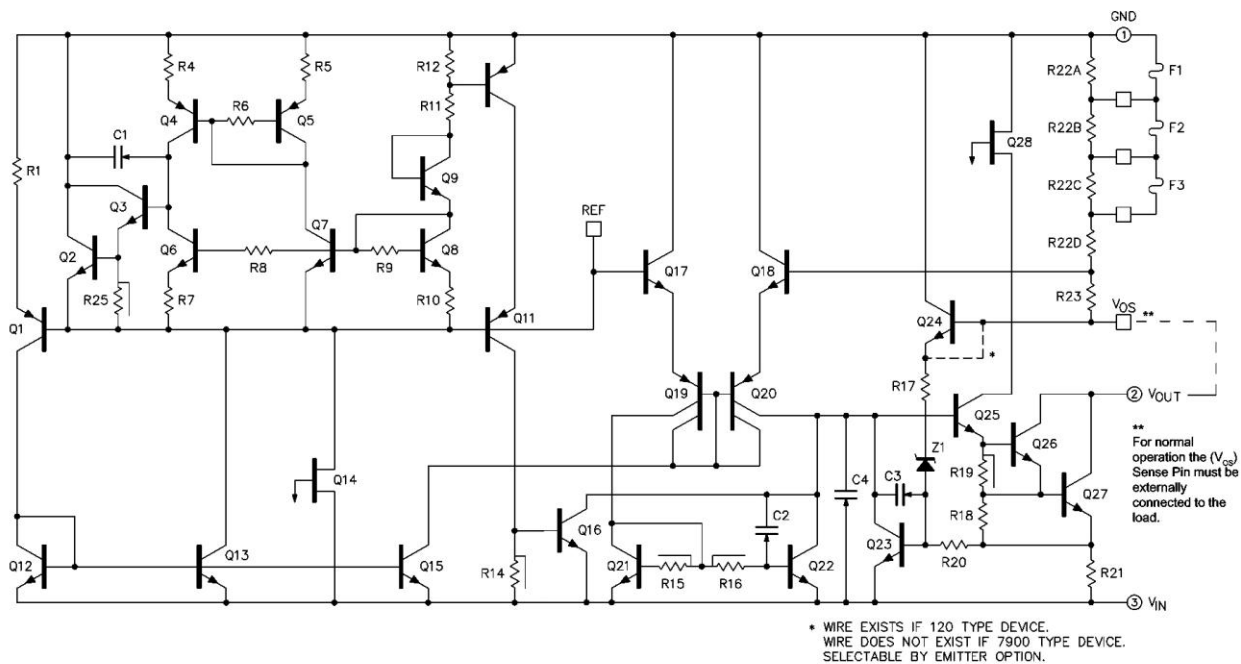
### FEATURES

- Output Voltage Set Internally to  $\pm 1.5\%$  on SG79xxA
- Output Current up to 1.5A
- Excellent Line and Load Regulation
- Foldback Current Limiting
- Thermal Overload Protection
- Voltages Available: -5V, -12V, -15V
- Contact Factory for Other Voltage Options
- Available in Surface Mount Package

### HIGH RELIABILITY FEATURES

- Available to MIL-STD - 883, ¶ 1.2.1
- MIL-M38510/11501BXA - SG7905T-JAN
- MIL-M38510/11505BYA - SG7905K-JAN
- MIL-M38510/11502BXA - SG7912T-JAN
- MIL-M38510/11506BYA - SG7912K-JAN
- MIL-M38510/11503BXA - SG7915T-JAN
- MIL-M38510/11507BYA - SG7915K-JAN
- MIL-M38510/11508BYA - SG7924K-JAN
- MSC-AMS level "S" Processing Available
- Available to DSCC  
Standard Microcircuit Drawing (SMD)

### SCHEMATIC DIAGRAM



## ABSOLUTE MAXIMUM RATINGS

Parameter	Value	Units
Device Output Voltage	-5, -12, -15	V
Input Voltage	-35, -40 ( $V_{OUT} \leq -15V$ )	V
Input Voltage Differential (Output Shorted to Ground)	35	V
Operating Junction Temperature	150	°C
Storage Temperature Range	-65 to 150	°C
Lead Temperature (Soldering 10 seconds)	300	°C

Note: Exceeding these ratings could cause damage to the device. All voltages are with respect to Ground. Currents are positive into, negative out of specified terminal.

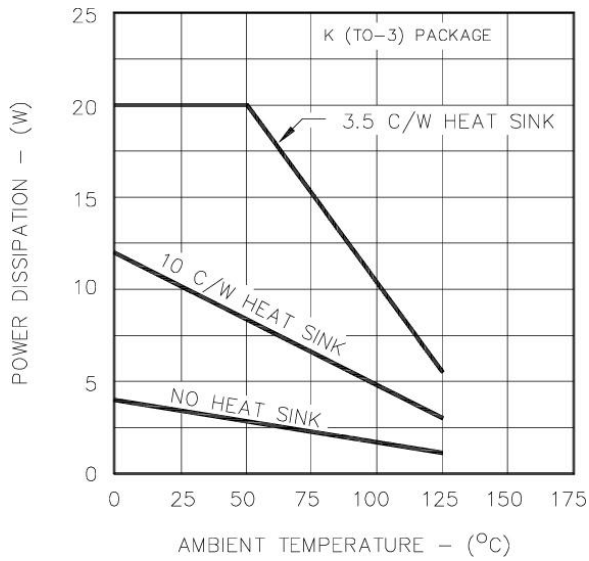
## THERMAL DATA

Parameter	Value	Units
<b>K Package TO-3 3-Pin Metal Can</b>		
Thermal Resistance-Junction to Case, $\theta_{JC}$	3	°C/W
Thermal Resistance-Junction to Ambient, $\theta_{JA}$	35	°C/W
<b>T Package TO-39 3-Pin Metal Can</b>		
Thermal Resistance-Junction to Case, $\theta_{JC}$	15	°C/W
Thermal Resistance-Junction to Ambient, $\theta_{JA}$	120	°C/W
<b>G Package TO-257 3-Pin Hermetic</b>		
Thermal Resistance-Junction to Case, $\theta_{JC}$	3.5	°C/W
Thermal Resistance-Junction to Ambient, $\theta_{JA}$	42	°C/W
<b>IG Package TO-257 3-Pin Hermetic (Isolated)</b>		
Thermal Resistance-Junction to Case, $\theta_{JC}$	4	°C/W
Thermal Resistance-Junction to Ambient, $\theta_{JA}$	42	°C/W
<b>L Package Leadless Chip Carrier 20-Pin Ceramic</b>		
Thermal Resistance-Junction to Case, $\theta_{JC}$	35	°C/W
Thermal Resistance-Junction to Ambient, $\theta_{JA}$	120	°C/W

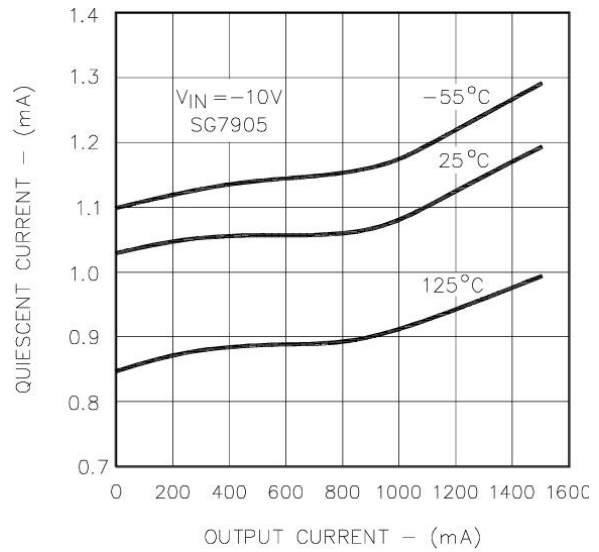
### Notes:

- 1: Junction Temperature Calculation:  $T_J = T_A + (P_D \times \theta_{JA})$ .
- 2: The  $\theta_{JA}$  numbers are guidelines for the thermal performance of the device/pc-board system. All of the above assume no ambient airflow.

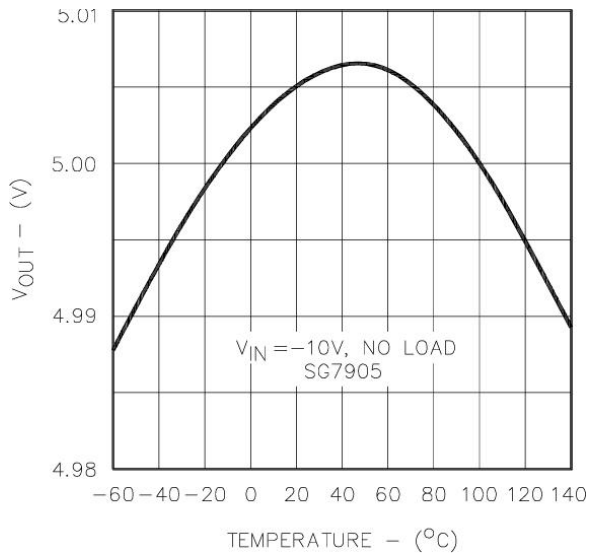
### CHARACTERISTIC CURVES



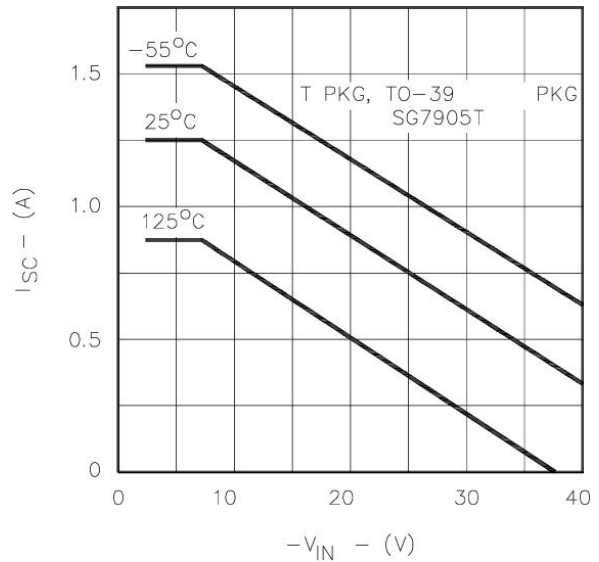
**Figure 1 – Maximum Average Power Dissipation**



**Figure 2 – Quiescent Current vs. Load**

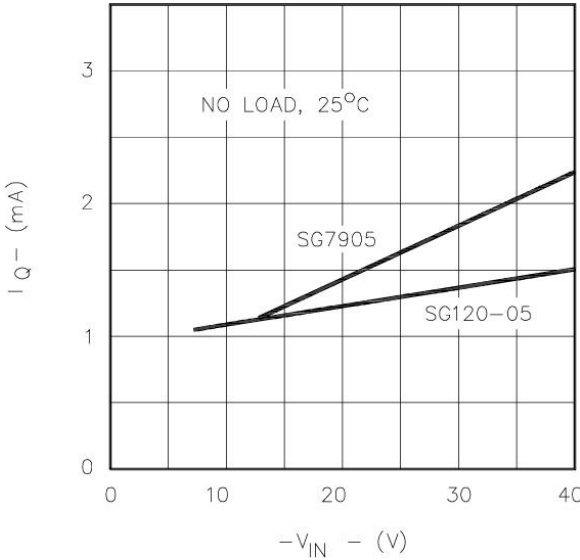


**Figure 3 – Temperature Coefficient**

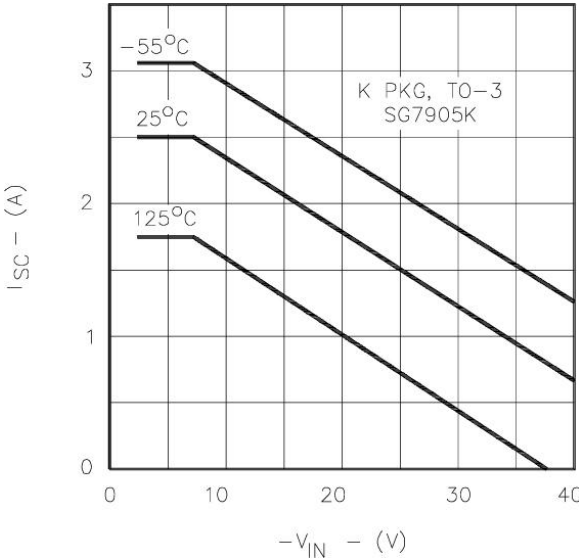


**Figure 4 – Short-circuit Current vs. V<sub>IN</sub>**

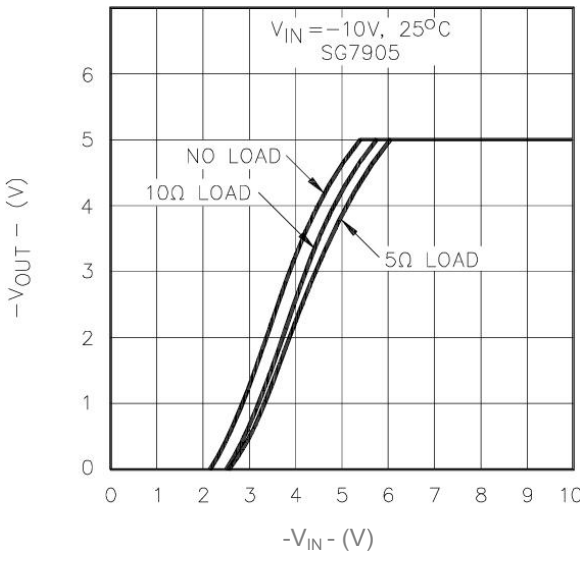
**CHARACTERISTIC CURVES** (continued)



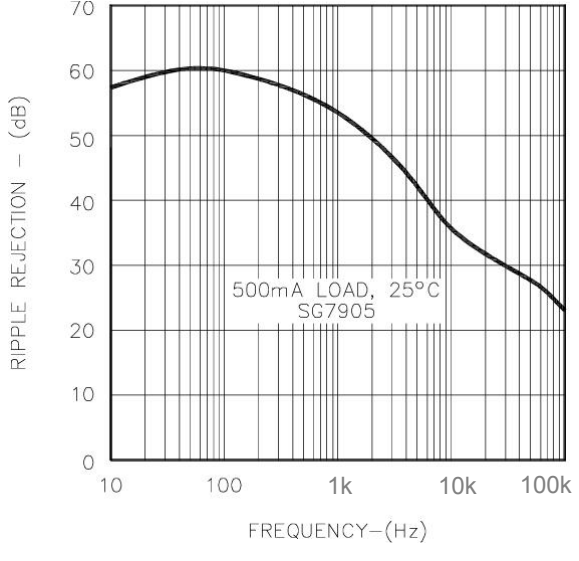
**Figure 5 – Quiescent Current vs.  $V_{IN}$**



**Figure 6 – Short-circuit Current vs.  $V_{IN}$**

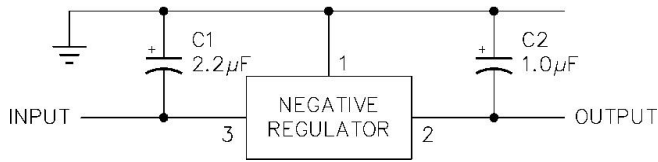


**Figure 7 – Dropout Characteristics**



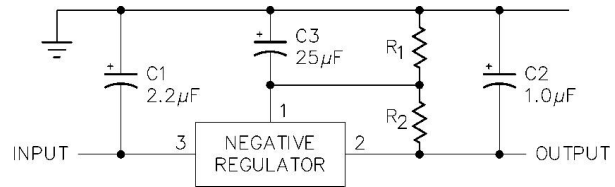
**Figure 8 – Ripple Rejection vs. Frequency**

## APPLICATION INFORMATION



**Figure 9 – Fixed Output Regulator**

- Note:
1. C1 is required only if regulator is separated from rectifier filter.
  2. Both C1 and C2 should be low E.S.R. types such as solid tantalum. If aluminum electrolytic capacitors are used, at least 10 times values shown should be selected.
  3. If large output capacities are used, the regulators must be protected from momentary input shorts. A high current diode is indicated from output to input.



**Figure 10 – Circuit for Increasing Output Voltage**

- Note: C3 optional for improved transient response and ripple rejection.

$$V_{\text{OUT}} = V(\text{REGULATOR}) \frac{R_1 + R_2}{R_1}$$

$$R_2 = \frac{V(\text{REG})}{15\text{mA}}$$

## RECOMMENDED OPERATING CONDITIONS

Parameter	SG79xx / 79xxA			Units
	Min	Typ	Max	
Operating Junction Temperature Range (Note 2)	-55		150	°C

Note 2: Range over which the device is functional.

## ELECTRICAL CHARACTERISTICS

Unless otherwise specified, these specifications apply over the operating ambient temperatures for SG7905A / SG7905 with  $-55^{\circ}\text{C} \leq T_A \leq 125^{\circ}\text{C}$ ,  $V_{IN} = -10\text{V}$ ,  $I_O = 500\text{mA}$  for the K, G, and IG - Power Packages,  $I_O = 100\text{mA}$  for the T and L packages,  $C_{IN} = 2\mu\text{F}$ , and  $C_{OUT} = 1\mu\text{F}$ . Low duty cycle pulse testing techniques are used which maintains junction and case temperatures equal to the ambient temperature.

Parameter	Test Conditions	SG7905A			SG7905			Units
		Min	Typ	Max	Min	Typ	Max	
Output Voltage	$T_J = 25^{\circ}\text{C}$	-4.95	-5.00	-5.05	-4.80	-5.00	-5.20	V
Line Regulation (Note 1)	$V_{IN} = -7.5\text{V to } -25\text{V}$ , $T_J = 25^{\circ}\text{C}$		5	25		3	50	mV
	$V_{IN} = -8\text{V to } -12\text{V}$ , $T_J = 25^{\circ}\text{C}$		3	12		1	25	mV
Load Regulation (Note 1)	Power Pkgs: $I_O = 5\text{mA to } 1.5\text{A}$ , $T_J = 25^{\circ}\text{C}$		15	75		15	100	mV
	$I_O = 250\text{mA to } 750\text{mA}$ , $T_J = 25^{\circ}\text{C}$		15	25		15	25	mV
	T - Pkg: $I_O = 5\text{mA to } 500\text{mA}$ , $T_J = 250^{\circ}\text{C}$		5	30		5	100	mV
Total Output Voltage Tolerance	$V_{IN} = -8\text{V to } -20\text{V}$ Power Pkgs: $I_O = 5\text{mA to } 1.0\text{A}$ , $P \leq 20\text{W}$	-4.85	-5.00	-5.15	-4.70	-5.00	-5.30	V
	$V_{IN} = -8\text{V to } -20\text{V}$ T - Pkg: $I_O = 5\text{mA to } 500\text{mA}$ , $P \leq 20\text{W}$	-4.85	-5.00	-5.15	-4.70	-5.00	-5.30	V
Quiescent Current	Over Temperature Range			2.5			2.5	mA
	$T_J = 25^{\circ}\text{C}$			2.0			2.0	mA
Quiescent Current Change	With Line: $V_{IN} = -8\text{V to } -25\text{V}$			1.3			1.3	mA
	With Load: $I_O = 5\text{mA to } 1.0\text{A}$ (Power Pkgs.)			0.5			0.5	mA
	$I_O = 5\text{mA to } 500\text{mA}$ (T)			0.5			0.5	mA
Dropout Voltage	$\Delta V_O = 100\text{mV}$ , $T_J = 25^{\circ}\text{C}$ Power Pkgs: $I_O = 1.0\text{A}$ , T-Pkg: $I_O = 500\text{mA}$		1.1	2.3		1.1	2.3	V
Peak Output Current	Power Pkgs: $T_J = 25^{\circ}\text{C}$	1.5		3.3	1.5		3.3	A
	T - Pkg: $T_J = 25^{\circ}\text{C}$	0.5		1.4	0.5		1.4	A
Short Circuit Current	Power Pkgs: $V_{IN} = -35\text{V}$ , $T_J = 25^{\circ}\text{C}$			1.2			1.2	A
	T - Pkg: $V_{IN} = -35\text{V}$ , $T_J = 25^{\circ}\text{C}$			0.6			0.6	A
Ripple Rejection	$\Delta V_{IN} = 10\text{V}$ , $f = 120\text{Hz}$ , $T_J = 25^{\circ}\text{C}$	54			54			dB
Output Noise Voltage (rms)	$f = 10\text{Hz to } 100\text{kHz}$ (Note 2)		25	80		25	80	$\mu\text{V/V}$
Long Term Stability	1000 hours @ $T_J = 125^{\circ}\text{C}$		20			20		mV
Thermal Shutdown	$I_O = 5\text{mA}$		175			175		$^{\circ}\text{C}$

Notes 1: All regulation tests are made at constant junction temperature with low duty cycle testing.  
2: This test is guaranteed but is not tested in production.

## ELECTRICAL CHARACTERISTICS (continued)

Unless otherwise specified, these specifications apply over the operating ambient temperatures for SG7912A / SG7912 with  $-55^{\circ}\text{C} \leq T_A \leq 125^{\circ}\text{C}$ ,  $V_{IN} = -19\text{V}$ ,  $I_O = 500\text{mA}$  for the K, G, and IG - Power Packages,  $I_O = 100\text{mA}$  for the T and L packages,  $C_{IN} = 2\mu\text{F}$ , and  $C_{OUT} = 1\mu\text{F}$ . Low duty cycle pulse testing techniques are used which maintains junction and case temperatures equal to the ambient temperature.

Parameter	Test Conditions	SG7912A			SG7912			Units
		Min	Typ	Max	Min	Typ	Max	
Output Voltage	$T_J = 25^{\circ}\text{C}$	-11.8	-12.0	-12.2	-11.5	-12.0	-12.5	V
Line Regulation (Note 1)	$V_{IN} = -14.5\text{V to } -30\text{V}$ , $T_J = 25^{\circ}\text{C}$		4	60		10	120	mV
	$V_{IN} = -16\text{V to } -22\text{V}$ , $T_J = 25^{\circ}\text{C}$		3	30		3	60	mV
Load Regulation (Note 1)	Power Pkgs: $I_O = 5\text{mA to } 1.5\text{A}$ , $T_J = 25^{\circ}\text{C}$		20	90		12	120	mV
	$I_O = 250\text{mA to } 750\text{mA}$ , $T_J = 25^{\circ}\text{C}$		10	40		10	60	mV
	T - Pkg: $I_O = 5\text{mA to } 500\text{mA}$ , $T_J = 25^{\circ}\text{C}$		10	40		10	240	mV
Total Output Voltage Tolerance	$V_{IN} = -14.5\text{V to } -27\text{V}$ Power Pkgs: $I_O = 5\text{mA to } 1.0\text{A}$ , $P \leq 20\text{W}$	-11.7	-12.0	-12.3	-11.4	-12.0	-12.6	V
	$V_{IN} = -14.5\text{V to } -27\text{V}$ T - Pkg: $I_O = 5\text{mA to } 500\text{mA}$ , $P \leq 2\text{W}$	-11.7	-12.0	-12.3	-11.4	-12.0	-12.6	V
Quiescent Current	Over Temperature Range			4			4	mA
	$T_J = 25^{\circ}\text{C}$			3			3	mA
Quiescent Current Change	With Line: $V_{IN} = -14.5\text{V to } -30\text{V}$			1.0			1.0	mA
	With Load: $I_O = 5\text{mA to } 1.0\text{A}$ (Power Pkgs.)			0.5			0.5	mA
	$I_O = 5\text{mA to } 500\text{mA}$ (T)			0.5			0.5	mA
Dropout Voltage	$\Delta V_O = 100\text{mV}$ , $T_J = 25^{\circ}\text{C}$ Power Pkgs: $I_O = 1.0\text{A}$ , T - Pkg: $I_O = 500\text{mA}$		1.1	2.3		1.1	2.3	V
Peak Output Current	Power Pkgs: $T_J = 25^{\circ}\text{C}$	1.5		3.3	1.5		3.3	A
	T - Pkg: $T_J = 25^{\circ}\text{C}$	0.5		1.4	0.5		1.4	A
Short Circuit Current	Power Pkgs: $V_{IN} = -35\text{V}$ , $T_J = 25^{\circ}\text{C}$			1.2			0.2	A
	T - Pkg: $V_{IN} = -35\text{V}$ , $T_J = 25^{\circ}\text{C}$			0.6			0.6	A
Ripple Rejection	$\Delta V_{IN} = 10\text{V}$ , $f = 120\text{Hz}$ , $T_J = 25^{\circ}\text{C}$	54			54			dB
Output Noise Voltage (rms)	$f = 10\text{Hz to } 100\text{kHz}$ (note 2)		25	80		25	80	$\mu\text{V/V}$
Long Term Stability	1000 hours @ $T_J = 125^{\circ}\text{C}$		60			60		mV
Thermal Shutdown	$I_O = 5\text{mA}$		175			175		$^{\circ}\text{C}$

- Notes 1: All regulation tests are made at constant junction temperature with low duty cycle testing.  
2: This test is guaranteed but is not tested in production.

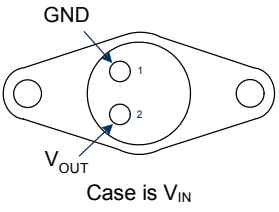
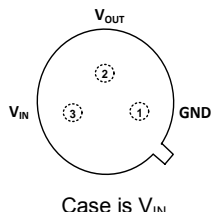
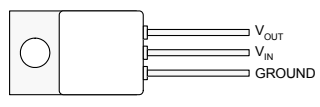
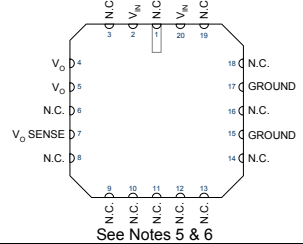
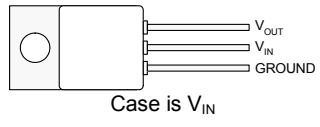
## ELECTRICAL CHARACTERISTICS (continued)

Unless otherwise specified, these specifications apply over the operating ambient temperatures for SG7915A / SG7915 with  $-55^{\circ}\text{C} \leq T_A \leq 125^{\circ}\text{C}$ ,  $V_{IN} = -23\text{V}$ ,  $I_O = 500\text{mA}$  for the K, G, and IG - Power Packages,  $I_O = 100\text{mA}$  for the T and L packages,  $C_{IN} = 2\mu\text{F}$ , and  $C_{OUT} = 1\mu\text{F}$ . Low duty cycle pulse testing techniques are used which maintains junction and case temperatures equal to the ambient temperature.

Parameter	Test Conditions	SG7915A			SG7915			Units
		Min	Typ	Max	Min	Typ	Max	
Output Voltage	$T_J = 25^{\circ}\text{C}$	-14.8	-15.0	-15.2	-14.4	-15.0	-15.6	V
Line Regulation (Note 1)	$V_{IN} = -17.5\text{V to } -30\text{V}$ , $T_J = 25^{\circ}\text{C}$		5	75		11	150	mV
	$V_{IN} = -20\text{V to } -25\text{V}$ , $T_J = 25^{\circ}\text{C}$		3	40		3	75	mV
Load Regulation (Note 1)	Power Pkgs: $I_O = 5\text{mA to } 1.5\text{A}$ , $T_J = 25^{\circ}\text{C}$		30	100		12	150	mV
	$I_O = 250\text{mA to } 750\text{mA}$ , $T_J = 25^{\circ}\text{C}$		4	50		4	75	mV
	T - Pkg: $I_O = 5\text{mA to } 500\text{mA}$ , $T_J = 25^{\circ}\text{C}$		10	50		10	240	mV
Total Output Voltage Tolerance	$V_{IN} = -18.5\text{V to } -30\text{V}$ Power Pkgs: $I_O = 5\text{mA to } 1.0\text{A}$ , $P \leq 20\text{W}$	-14.6	-15.0	-15.4	-14.25	-15.00	-15.75	V
	$V_{IN} = -18.5\text{V to } -30\text{V}$ T - Pkg: $I_O = 5\text{mA to } 500\text{mA}$ , $P \leq 2\text{W}$	-14.6	-15.0	-15.4	-14.25	-15.00	-15.75	V
Quiescent Current	Over Temperature Range			4			4	mA
	$T_J = 25^{\circ}\text{C}$			3			3	mA
Quiescent Current Change	With Line: $V_{IN} = -18.5\text{V to } -30\text{V}$			1.0			1.0	mA
	With Load: $I_O = 5\text{mA to } 1.0\text{A}$ (Power Pkgs)			0.5			0.5	mA
	$I_O = 5\text{mA to } 500\text{mA}$ (T)			0.5			0.5	mA
Dropout Voltage	$\Delta V_O = 100\text{mV}$ , $T_J = 25^{\circ}\text{C}$ Power Pkgs: $I_O = 1.0\text{A}$ , T - Pkg: $I_O = 500\text{mA}$		1.1	2.3		1.1	2.3	V
Peak Output Current	Power Pkgs: $T_J = 25^{\circ}\text{C}$	1.5		3.3	1.5		3.3	A
	T - Pkg: $T_J = 25^{\circ}\text{C}$	0.5		1.4	0.5		1.4	A
Short Circuit Current	Power Pkgs: $V_{IN} = -35\text{V}$ , $T_J = 25^{\circ}\text{C}$			1.2			1.2	A
	T - Pkg: $V_{IN} = -35\text{V}$ , $T_J = 25^{\circ}\text{C}$			0.6			0.6	A
Ripple Rejection	$\Delta V_{IN} = 10\text{V}$ , $f = 120\text{Hz}$ , $T_J = 25^{\circ}\text{C}$	54			54			dB
Output Noise Voltage (rms)	$f = 10\text{Hz to } 100\text{kHz}$ (note 2)		25	80		25	80	$\mu\text{V/V}$
Long Term Stability	1000 hours @ $T_J = 125^{\circ}\text{C}$		60			60		mV
Thermal Shutdown	$I_O = 5\text{mA}$		175			175		$^{\circ}\text{C}$

Notes 1: All regulation tests are made at constant junction temperature with low duty cycle testing.  
2: This test is guaranteed but is not tested in production.

**CONNECTION DIAGRAMS & ORDERING INFORMATION** (See Notes Below)

Package	Part No.	Ambient Temperature Range	Connection Diagram
3-Terminal TO-3 Metal Can K – Package	SG79xxAK-883B	-55°C to 125°C	 <p>Case is <math>V_{IN}</math></p>
	SG7905AK-DESC	-55°C to 125°C	
	SG7912AK-DESC	-55°C to 125°C	
	SG7915AK-DESC	-55°C to 125°C	
	SG79xxAK	-55°C to 125°C	
	SG79xxK-883B	-55°C to 125°C	
	SG7905K-JAN	-55°C to 125°C	
	SG7912K-JAN	-55°C to 125°C	
3-Pin TO-39 Metal Can T – Package	SG79xxAT-883B	-55°C to 125°C	 <p>Case is <math>V_{IN}</math></p>
	SG7905AT-DESC	-55°C to 125°C	
	SG7912AT-DESC	-55°C to 125°C	
	SG7915AT-DESC	-55°C to 125°C	
	SG79xxAT	-55°C to 125°C	
	SG79xxT-883B	-55°C to 125°C	
	SG7905T-JAN	-55°C to 125°C	
	SG7912T-JAN	-55°C to 125°C	
3-Pin Hermetic TO-257 IG – Package (Isolated)	SG79xxAIG-883B	-55°C to 125°C	
	SG7905AIG-DESC	-55°C to 125°C	
	SG7912AIG-DESC	-55°C to 125°C	
	SG7915AIG-DESC	-55°C to 125°C	
	SG79xxAIG	-55°C to 125°C	
	SG79xxIG-883B	-55°C to 125°C	
20-Pin Ceramic Leadless Chip Carrier L – Package	SG79xxL-883B	-55°C to 125°C	 <p>See Notes 5 &amp; 6</p>
	SG79xxL	-55°C to 125°C	
	SG7905AL-DESC	-55°C to 125°C	
	SG7912AL-DESC	-55°C to 125°C	
	SG7912AL-DESC	-55°C to 125°C	
3-Pin Hermetic TO-257 G – Package (Case is $V_{IN}$ )	SG79xxAG-883B	-55°C to 125°C	 <p>Case is <math>V_{IN}</math></p>
	SG7905AG-DESC	-55°C to 125°C	
	SG7912AG-DESC	-55°C to 125°C	
	SG7915AG-DESC	-55°C to 125°C	
	SG79xxAG	-55°C to 125°C	
	SG79xxG-883B	-55°C to 125°C	
SG79xxG	-55°C to 125°C		

- Notes
- 1: Contact factory for JAN and DESC product availability.
  - 2: All parts are viewed from the top.
  - 3: “xx” to be replaced by output voltage of specific fixed regulator.
  - 4: Some products will be available in hermetic flat pack (F). Consult factory for price and availability.
  - 5: Both inputs and outputs must be externally connected together at the device terminals.
  - 6: For normal operation, the  $V_O$  SENSE pin must be externally connected to the load.

## PACKAGE OUTLINE DIMENSIONS

Controlling dimensions are in inches, metric equivalents are shown for general information.

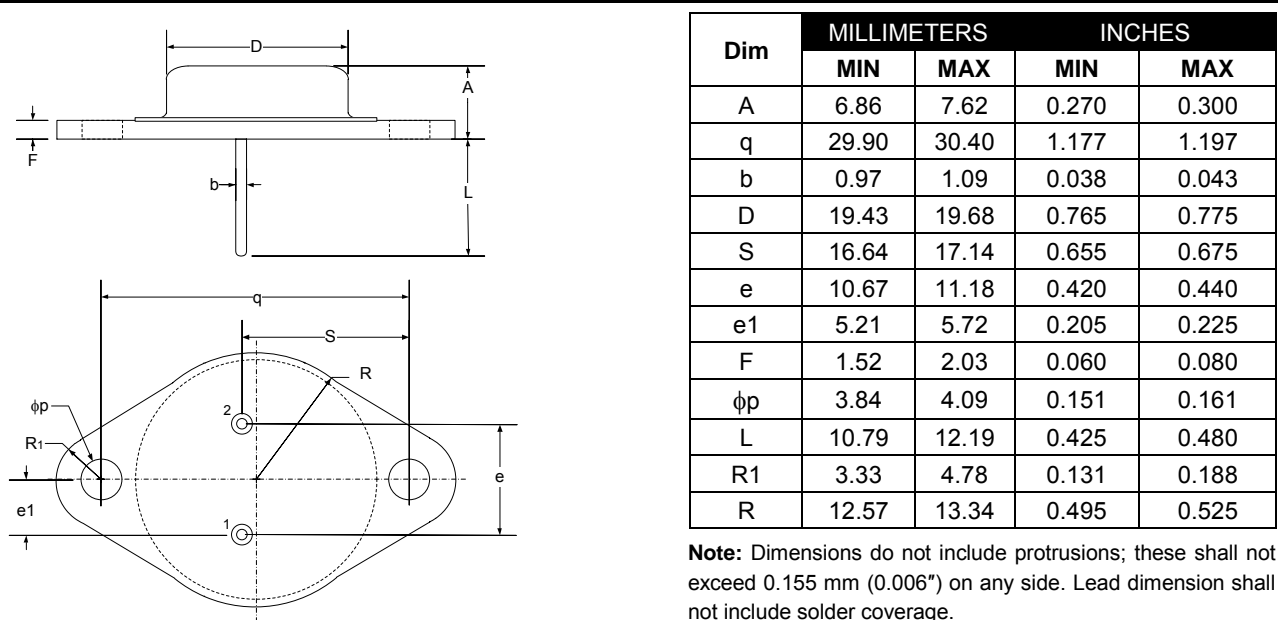


Figure 11 - K 3-Pin Metal Can TO-3

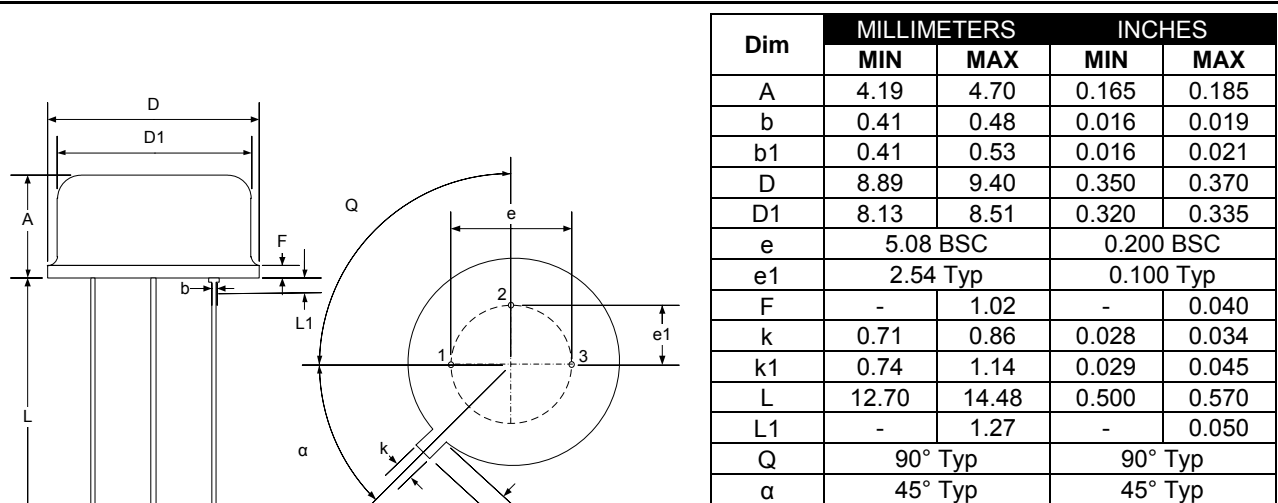
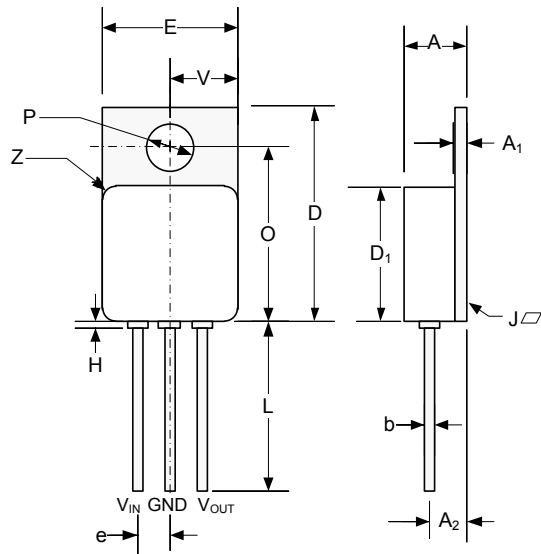


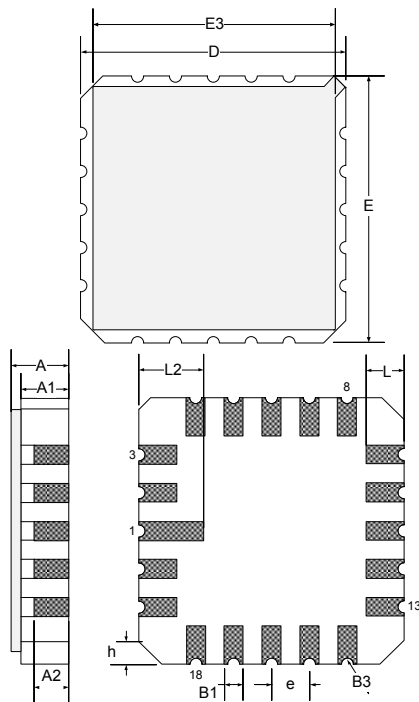
Figure 12 - T 3-Pin Metal Can TO-39

**PACKAGE OUTLINE DIMENSIONS** (continued)


Dim	MILLIMETERS		INCHES	
	MIN	MAX	MIN	MAX
A	4.70	5.21	0.185	0.205
A1	0.89	1.14	0.035	0.045
A2	2.92	3.18	0.115	0.125
b	0.71	0.081	0.027	0.032
D	16.38	16.76	0.645	0.660
D1*	10.41	10.92	0.410	0.430
e	2.54 BSC		0.100 BSC	
E*	10.41	10.67	0.410	0.420
H		0.50		0.020
L	12.70		0.500	
O	13.39	13.64	0.527	0.537
P	3.56	3.81	0.140	0.150
J		0.10		0.004
V	5.13	5.38	0.202	0.212
Z	1.40 Typ		0.055 Typ	

\*Excludes Weld Fillet Around Lid.

**Note:** Dimensions do not include protrusions; these shall not exceed 0.155 mm (0.006") on any side. Lead dimension shall not include solder coverage.

**Figure 13 • G/IG 3-Pin Hermetic TO-257**


Dim	MILLIMETERS		INCHES	
	MIN	MAX	MIN	MAX
D, E	8.64	9.14	0.340	0.360
E3	-	8.128	-	0.320
e	1.270 BSC		0.050 BSC	
B1	0.635 Typ		0.025 Typ	
L	1.02	1.52	0.040	0.060
A	1.626	2.286	0.064	0.090
h	1.016 Typ		0.040 Typ	
A1	1.372	1.68	0.054	0.066
A2	-	1.168	-	0.046
L2	1.91	2.41	0.075	0.95
B3	0.203R		0.008R	

**Note:** All exposed metalized area shall be gold plated 60  $\mu$ -inch minimum thickness over nickel plated unless specified in purchase order. Lead dimension shall not include solder coverage.

**Figure 14 • L 20-Pin Ceramic Leadless Chip Carrier**



**Microsemi Corporate Headquarters**  
One Enterprise, Aliso Viejo,  
CA 92656 USA

**Within the USA:** +1 (800) 713-4113  
**Outside the USA:** +1 (949) 380-6100  
**Sales:** +1 (949) 380-6136  
**Fax:** +1 (949) 215-4996

**E-mail:** [sales.support@microsemi.com](mailto:sales.support@microsemi.com)



© 2015 Microsemi Corporation. All rights reserved. Microsemi and the Microsemi logo are trademarks of Microsemi Corporation. All other trademarks and service marks are the property of their respective owners.

Microsemi Corporation (Nasdaq: MSCC) offers a comprehensive portfolio of semiconductor and system solutions for communications, defense & security, aerospace and industrial markets. Products include high-performance and radiation-hardened analog mixed-signal integrated circuits, FPGAs, SoCs and ASICs; power management products; timing and synchronization devices and precise time solutions, setting the world's standard for time; voice processing devices; RF solutions; discrete components; security technologies and scalable anti-tamper products; Power-over-Ethernet ICs and midspans; as well as custom design capabilities and services. Microsemi is headquartered in Aliso Viejo, Calif., and has approximately 3,400 employees globally. Learn more at [www.microsemi.com](http://www.microsemi.com).

Microsemi makes no warranty, representation, or guarantee regarding the information contained herein or the suitability of its products and services for any particular purpose, nor does Microsemi assume any liability whatsoever arising out of the application or use of any product or circuit. The products sold hereunder and any other products sold by Microsemi have been subject to limited testing and should not be used in conjunction with mission-critical equipment or applications. Any performance specifications are believed to be reliable but are not verified, and Buyer must conduct and complete all performance and other testing of the products, alone and together with, or installed in, any end-products. Buyer shall not rely on any data and performance specifications or parameters provided by Microsemi. It is the Buyer's responsibility to independently determine suitability of any products and to test and verify the same. The information provided by Microsemi hereunder is provided "as is, where is" and with all faults, and the entire risk associated with such information is entirely with the Buyer. Microsemi does not grant, explicitly or implicitly, to any party any patent rights, licenses, or any other IP rights, whether with regard to such information itself or anything described by such information. Information provided in this document is proprietary to Microsemi, and Microsemi reserves the right to make any changes to the information in this document or to any products and services at any time without notice.

## Looking for pricing, stock, or lifecycle information?

Click below to explore more details on WIN SOURCE:

-  [View SG7908T on WIN SOURCE](#)
-  [Microchip Technology](#) Information

## Optimize Your Supply Chain with WIN SOURCE Solutions

-  Global Sourcing Solution
-  Obsolete Management
-  Cost Control Management
-  Shortage Management
-  Alternative Solution
-  Excess Inventory Management