



# THE DATASHEET OF CY7B994V-2AXC





## Features

- 500 ps Max Total Timing Budget (TTB™) window
- 12 MHz to 100 MHz (CY7B993V), or 24 MHz to 200 MHz (CY7B994V) Input/Output Operation
- Matched Pair Output Skew < 200 ps
- Zero Input-to-Output Delay
- 18 LVTTTL Outputs Driving 50Ω Terminated Lines
- 16 Outputs at 200 MHz: Commercial Temperature
- 6 Outputs at 200 MHz: Industrial Temperature
- 3.3V LVTTTL/LVPECL, Fault-tolerant, and Hot Insertable Reference Inputs
- Phase Adjustments in 625 ps/1300 ps Steps Up to ± 10.4 ns
- Multiply/Divide Ratios of 1–6, 8, 10, 12
- Individual Output Bank Disable
- Output High Impedance Option for Testing Purposes
- Fully Integrated Phase Locked Loop (PLL) with Lock Indicator
- <50-ps Typical Cycle-to-Cycle Jitter
- Single 3.3V ± 10% Supply
- 100-pin TQFP Package
- 100-pin BGA Package

## Functional Description

The CY7B993V and CY7B994V High-speed Multi-phase PLL Clock Buffers offer user selectable control over system clock functions. This multiple output clock driver provides the system integrator with functions necessary to optimize the timing of high-performance computer and communication systems.

These devices feature a guaranteed maximum TTB window specifying all occurrences of output clocks with respect to the input reference clock across variations in output frequency, supply voltage, operating temperature, input edge rate, and process.

Eighteen configurable outputs each drive terminated transmission lines with impedances as low as 50Ω while delivering minimal and specified output skews at LVTTTL levels. The outputs are arranged in five banks. Banks 1 to 4 of four outputs allow a divide function of 1 to 12, while simultaneously allowing phase adjustments in 625 ps to 1300 ps increments up to 10.4 ns. One of the output banks also includes an independent clock invert function. The feedback bank consists of two outputs, which allows divide-by functionality from 1 to 12 and limited phase adjustments. Any one of these eighteen outputs can be connected to the feedback input as well as driving other inputs.

Selectable reference input is a fault tolerance feature that allows smooth change-over to secondary clock source, when the primary clock source is not in operation. The reference inputs and feedback inputs are configurable to accommodate both LVTTTL or Differential (LVPECL) inputs. The completely integrated PLL reduces jitter and simplifies board layout.

For a complete list of related documentation, [click here](#).

Logic Block Diagram

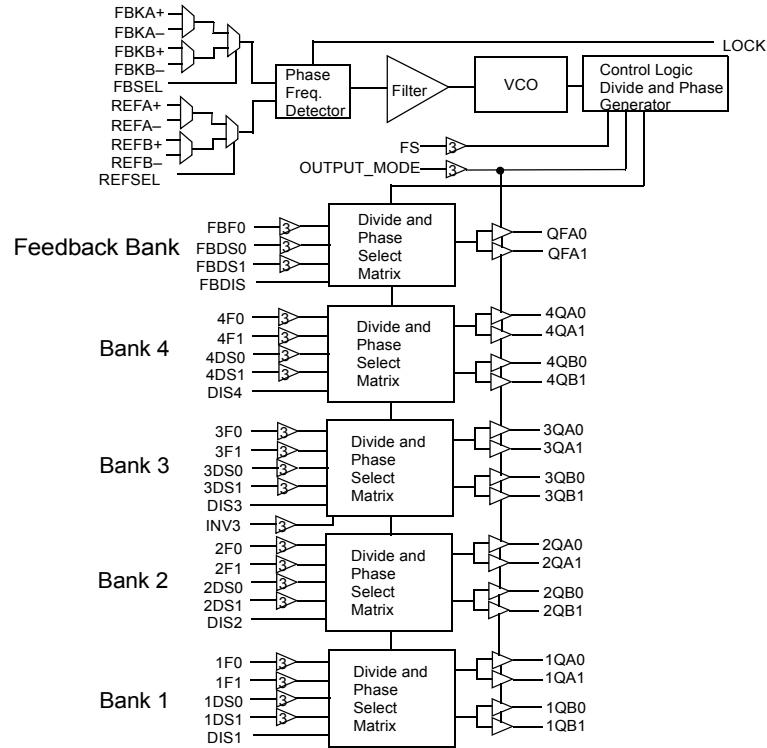

## Contents

<b>Pinouts</b> .....	<b>4</b>	<b>AC Test Loads and Waveforms</b> .....	<b>13</b>
<b>Pin Definition</b> .....	<b>6</b>	<b>Switching Characteristics</b> .....	<b>14</b>
<b>Block Diagram Description</b> .....	<b>7</b>	<b>AC Timing Diagrams</b> .....	<b>16</b>
Phase Frequency Detector and Filter .....	7	<b>Ordering Information</b> .....	<b>17</b>
VCO, Control Logic, Divider, and Phase Generator .....	7	Ordering Code Definitions .....	17
Time Unit Definition .....	7	<b>Package Diagrams</b> .....	<b>18</b>
Divide and Phase Select Matrix .....	8	<b>Acronyms</b> .....	<b>20</b>
Output Disable Description .....	9	<b>Document Conventions</b> .....	<b>20</b>
INV3 Pin Function .....	10	Units of Measure .....	20
Lock Detect Output Description .....	10	<b>Document History Page</b> .....	<b>21</b>
Factory Test Mode Description .....	10	<b>Sales, Solutions, and Legal Information</b> .....	<b>23</b>
Safe Operating Zone .....	10	Worldwide Sales and Design Support .....	23
<b>Absolute Maximum Conditions</b> .....	<b>11</b>	Products .....	23
<b>Operating Range</b> .....	<b>11</b>	PSoC@Solutions .....	23
<b>Electrical Characteristics</b> .....	<b>11</b>	Cypress Developer Community .....	23
<b>Thermal Resistance</b> .....	<b>13</b>	Technical Support .....	23

Pinouts

Figure 1. 100-pin TQFP pinout

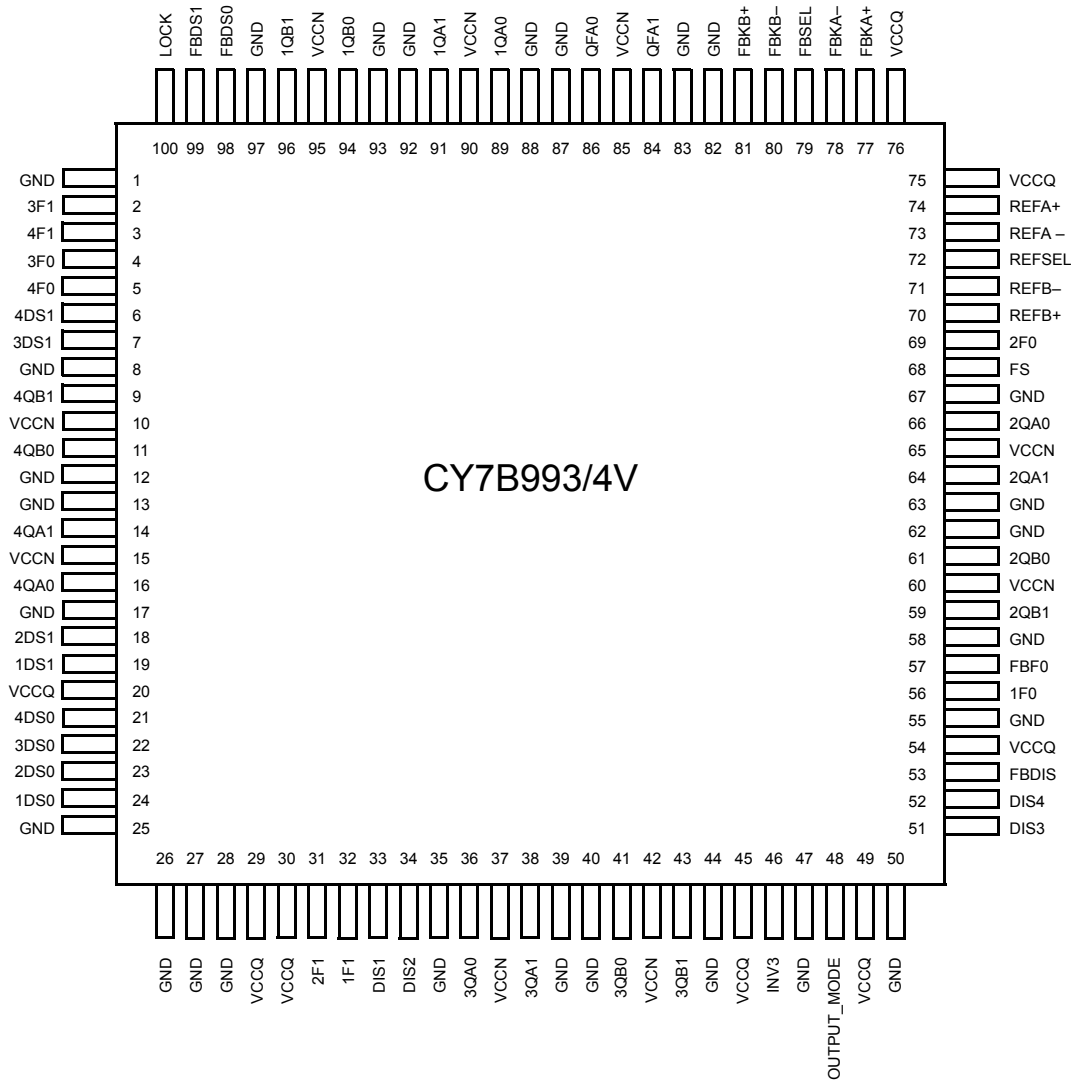

**Pinouts** (continued)

**Figure 2. 100-pin BGA pinout**

	1	2	3	4	5	6	7	8	9	10
<b>A</b>	1QB1	1QB0	1QA1	1QA0	QFA0	QFA1	FBKB+	VCCQ	FBKA-	FBKA+
<b>B</b>	VCCN	VCCN	VCCN	VCCN	VCCN	VCCN	VCCQ	FBKB-	FBSEL	REFA+
<b>C</b>	GND	GND	GND	GND	GND	GND	VCCQ	GND	GND	REFA-
<b>D</b>	LOCK	4F0 (3_level)	3F1 (3_level)	GND	FBDS1 (3_level)	FBDS0 (3_level)	2F0 (3_level)	VCCQ	REFSEL	REFB-
<b>E</b>	4QB1	VCCN	4DS1 (3_level)	GND	3F0 (3_level)	4F1 (3_level)	GND	FS (3_level)	VCCN	REFB+
<b>F</b>	4QB0	VCCN	3DS1 (3_level)	GND	GND	GND	GND	FBF0 (3_level)	VCCN	2QA0
<b>G</b>	4QA1	2DS1 (3_level)	VCCQ	GND	GND	GND	GND	VCCQ	1F0 (3_level)	2QA1
<b>H</b>	4QA0	1DS1 (3_level)	1DS0 (3_level)	VCCQ	GND	GND	VCCQ	OUTPUT MODE (3_level)	FBDIS	2QB0
<b>J</b>	4DS0 (3_level)	3DS0 (3_level)	2DS0 (3_level)	DIS1	VCCN	VCCN	GND	INV3 (3_level)	DIS3	2QB1
<b>K</b>	2F1 (3_level)	1F1 (3_level)	DIS2	VCCN	3QA0	3QA1	GND	3QB0	3QB1	DIS4



## Pin Definition

Pin Name <sup>[1]</sup>	I/O	Pin Type	Pin Description
FBSEL	Input	LVTTL	<b>Feedback Input Select.</b> When LOW, FBKA inputs are selected. When HIGH, the FBKB inputs are selected. This input has an internal pull-down.
FBKA+, FBKA–, FBKB+, FBKB–	Input	LVTTL/ LVDIFF	<b>Feedback Inputs.</b> One pair of inputs selected by the FBSEL is used to feedback the clock output xQn to the phase detector. The PLL operates such that the rising edges of the reference and feedback signals are aligned in both phase and frequency. These inputs can operate as differential PECL or single-ended TTL inputs. When operating as a single-ended LVTTL input, the complementary input must be left open.
REFA+, REFA–, REFB+, REFB–	Input	LVTTL/ LVDIFF	<b>Reference Inputs.</b> These inputs can operate as differential PECL or single-ended TTL reference inputs to the PLL. When operating as a single-ended LVTTL input, the complementary input must be left open.
REFSEL	Input	LVTTL	<b>Reference Select Input.</b> The REFSEL input controls how the reference input is configured. When LOW, it uses the REFA pair as the reference input. When HIGH, it uses the REFB pair as the reference input. This input has an internal pull-down.
FS	Input	3-level Input	<b>Frequency Select.</b> This input must be set according to the nominal frequency ( $f_{NOM}$ ) (see <a href="#">Table 1 on page 7</a> ).
FBF0	Input	3-level Input	<b>Feedback Output Phase Function Select.</b> This input determines the phase function of the Feedback bank's QFA[0:1] outputs (see <a href="#">Table 3 on page 8</a> ).
FBDS[0:1]	Input	3-level Input	<b>Feedback Divider Function Select.</b> These inputs determine the function of the QFA0 and QFA1 outputs (see <a href="#">Table 4 on page 8</a> ).
FBDIS	Input	LVTTL	<b>Feedback Disable.</b> This input controls the state of QFA[0:1]. When HIGH, the QFA[0:1] is disabled to the "HOLD-OFF" or "High Z" state; the disable state is determined by OUTPUT_MODE. When LOW, the QFA[0:1] is enabled (see <a href="#">Table 5 on page 9</a> ). This input has an internal pull-down.
[1:4]F[0:1]	Input	3-level Input	<b>Output Phase Function Select.</b> Each pair controls the phase function of the respective bank of outputs (see <a href="#">Table 3 on page 8</a> ).
[1:4]DS[0:1]	Input	3-level Input	<b>Output Divider Function Select.</b> Each pair controls the divider function of the respective bank of outputs (see <a href="#">Table 4 on page 8</a> ).
DIS[1:4]	Input	LVTTL	<b>Output Disable.</b> Each input controls the state of the respective output bank. When HIGH, the output bank is disabled to the "HOLD-OFF" or "High Z" state; the disable state is determined by OUTPUT_MODE. When LOW, the [1:4]Q[A:B][0:1] is enabled (see <a href="#">Table 5 on page 9</a> ). These inputs each have an internal pull-down.
INV3	Input	3-level Input	<b>Invert Mode.</b> This input only affects Bank 3. When this input is LOW, each matched output pair becomes complementary (3QA0+, 3QA1–, 3QB0+, 3QB1–). When this input is HIGH, all four outputs in the same bank are inverted. When this input is MID all four outputs are non inverting.
LOCK	Output	LVTTL	<b>PLL Lock Indicator.</b> When HIGH, this output indicates the internal PLL is locked to the reference signal. When LOW, the PLL is attempting to acquire lock.
OUTPUT_MODE	Input	3-Level Input	<b>Output Mode.</b> This pin determines the clock outputs' disable state. When this input is HIGH, the clock outputs disable to high impedance (High Z). When this input is LOW, the clock outputs disable to "HOLD-OFF" mode. When in MID, the device enters factory test mode.
QFA[0:1]	Output	LVTTL	<b>Clock Feedback Output.</b> This pair of clock outputs is intended to be connected to the FB input. These outputs have numerous divide options and three choices of phase adjustments. The function is determined by the setting of the FBDS[0:1] pins and FBF0.
[1:4]Q[A:B][0:1]	Output	LVTTL	<b>Clock Output.</b> These outputs provide numerous divide and phase select functions determined by the [1:4]DS[0:1] and [1:4]F[0:1] inputs.
VCCN		PWR	<b>Output Buffer Power.</b> Power supply for each output pair.
VCCQ		PWR	<b>Internal Power.</b> Power supply for the internal circuitry.
GND		PWR	<b>Device Ground.</b>

### Note

- For all three-state inputs, HIGH indicates a connection to  $V_{CC}$ , LOW indicates a connection to GND, and MID indicates an open connection. Internal termination circuitry holds an unconnected input to  $V_{CC}/2$ .

## Block Diagram Description

### Phase Frequency Detector and Filter

These two blocks accept signals from the REF inputs (REFA+, REFA-, REFB+, or REFB-) and the FB inputs (FBKA+, FBKA-, FBKB+, or FBKB-). Correction information is then generated to control the frequency of the voltage-controlled oscillator (VCO). These two blocks, along with the VCO, form a PLL that tracks the incoming REF signal.

The CY7B993V/994V have a flexible REF and FB input scheme. These inputs allow the use of either differential LVPECL or single-ended LVTTTL inputs. To configure as single-ended LVTTTL inputs, the complementary pin must be left open (internally pulled to 1.5V). The other input pin can then be used as an LVTTTL input. The REF inputs are also tolerant to hot insertion.

The REF inputs can be changed dynamically. When changing from one reference input to the other of the same frequency, the PLL is optimized to ensure that the clock output period is not less than the calculated system budget ( $t_{MIN} = t_{REF}$  (nominal reference clock period) -  $t_{CCJ}$  (cycle-to-cycle jitter) -  $t_{PDEV}$  (Max period deviation)) while reacquiring the lock.

### VCO, Control Logic, Divider, and Phase Generator

The VCO accepts analog control inputs from the PLL filter block. The FS control pin setting determines the nominal operational frequency range of the divide by one output ( $f_{NOM}$ ) of the device.  $f_{NOM}$  is directly related to the VCO frequency. There are two versions: a low-speed device (CY7B993V) where  $f_{NOM}$  ranges from 12 MHz to 100 MHz, and a high-speed device (CY7B994V) that ranges from 24 MHz to 200 MHz. The FS setting for each device is shown in [Table 1](#).

The  $f_{NOM}$  frequency is seen on “divide-by-one” outputs. For the CY7B994V, the upper  $f_{NOM}$  range extends from 96 MHz to 200 MHz.

**Table 1. Frequency Range Select**

FS <sup>[2]</sup>	CY7B993V		CY7B994V	
	f <sub>NOM</sub> (MHz)		f <sub>NOM</sub> (MHz)	
	Min	Max	Min	Max
LOW	12	26	24	52
MID	24	52	48	100
HIGH	48	100	96	200

### Time Unit Definition

Selectable skew is in discrete increments of time unit ( $t_U$ ). The value of a  $t_U$  is determined by the FS setting and the maximum nominal output frequency. The equation to be used to determine the  $t_U$  value is as follows:

$$t_U = 1/(f_{NOM} * N)$$

N is a multiplication factor which is determined by the FS setting.  $f_{NOM}$  is nominal frequency of the device. N is defined in [Table 2](#).

**Table 2. N Factor Determination**

FS	CY7B993V		CY7B994V	
	N	f <sub>NOM</sub> (MHz) at which t <sub>U</sub> = 1.0 ns	N	f <sub>NOM</sub> (MHz) at which t <sub>U</sub> = 1.0 ns
LOW	64	15.625	32	31.25
MID	32	31.25	16	62.5
HIGH	16	62.5	8	125

**Note**

- The level to be set on FS is determined by the “nominal” operating frequency ( $f_{NOM}$ ) of the VCO and Phase Generator.  $f_{NOM}$  always appears on an output when the output is operating in the undivided mode. The REF and FB are at  $f_{NOM}$  when the output connected to FB is undivided.



### Divide and Phase Select Matrix

The Divide and Phase Select Matrix is comprised of five independent banks: four banks of clock outputs and one bank for feedback. Each clock output bank has two pairs of low-skew, high-fanout output buffers ([1:4]Q[A:B][0:1]), two phase function select inputs ([1:4]F[0:1]), two divider function selects ([1:4]DS[0:1]), and one output disable (DIS[1:4]).

The feedback bank has one pair of low-skew, high-fanout output buffers (QFA[0:1]). One of these outputs may connect to the selected feedback input (FBK[A:B]±). This feedback bank also has one phase function select input (FBF0), two divider function selects FSDS[0:1], and one output disable (FBDIS).

The phase capabilities that are chosen by the phase function select pins are shown in Table 3. The divide capabilities for each bank are shown in Table 4.

**Table 3. Output Skew Select Function**

Function Selects		Output Skew Function				
[1:4]F1	[1:4]F0 and FBF0	Bank1	Bank2	Bank3	Bank4	Feedback Bank
LOW	LOW	-4t <sub>U</sub>	-4t <sub>U</sub>	-8t <sub>U</sub>	-8t <sub>U</sub>	-4t <sub>U</sub>
LOW	MID	-3t <sub>U</sub>	-3t <sub>U</sub>	-7t <sub>U</sub>	-7t <sub>U</sub>	NA
LOW	HIGH	-2t <sub>U</sub>	-2t <sub>U</sub>	-6t <sub>U</sub>	-6t <sub>U</sub>	NA
MID	LOW	-1t <sub>U</sub>	-1t <sub>U</sub>	BK1 <sup>[3]</sup>	BK1 <sup>[3]</sup>	NA
MID	MID	0t <sub>U</sub>	0t <sub>U</sub>	0t <sub>U</sub>	0t <sub>U</sub>	0t <sub>U</sub>
MID	HIGH	+1t <sub>U</sub>	+1t <sub>U</sub>	BK2 <sup>[3]</sup>	BK2 <sup>[3]</sup>	NA
HIGH	LOW	+2t <sub>U</sub>	+2t <sub>U</sub>	+6t <sub>U</sub>	+6t <sub>U</sub>	NA
HIGH	MID	+3t <sub>U</sub>	+3t <sub>U</sub>	+7t <sub>U</sub>	+7t <sub>U</sub>	NA
HIGH	HIGH	+4t <sub>U</sub>	+4t <sub>U</sub>	+8t <sub>U</sub>	+8t <sub>U</sub>	+4t <sub>U</sub>

**Note**

3. BK1, BK2 denotes following the skew setting of Bank1 and Bank2, respectively.

**Table 4. Output Divider Function**

Function Selects		Output Divider Function				
[1:4]DS1 and FBDS1	[1:4]DS0 and FBDS0	Bank1	Bank2	Bank3	Bank4	Feedback Bank
LOW	LOW	/1	/1	/1	/1	/1
LOW	MID	/2	/2	/2	/2	/2
LOW	HIGH	/3	/3	/3	/3	/3
MID	LOW	/4	/4	/4	/4	/4
MID	MID	/5	/5	/5	/5	/5
MID	HIGH	/6	/6	/6	/6	/6
HIGH	LOW	/8	/8	/8	/8	/8
HIGH	MID	/10	/10	/10	/10	/10
HIGH	HIGH	/12	/12	/12	/12	/12

Figure 3 on page 9 illustrates the timing relationship of programmable skew outputs. All times are measured with respect to REF with the output used for feedback programmed with 0t<sub>U</sub> skew. The PLL naturally aligns the rising edge of the FB input and REF input. If the output used for feedback is programmed to another skew position, then the whole t<sub>U</sub> matrix shifts with respect to REF. For example, if the output used for feedback is programmed to shift -8t<sub>U</sub>, then the whole matrix is shifted forward in time by 8t<sub>U</sub>. Thus an output programmed with 8t<sub>U</sub> of skew is effectively skewed 16t<sub>U</sub> with respect to REF.

Figure 3. Typical Outputs with FB Connected to a Zero-Skew Output [4]

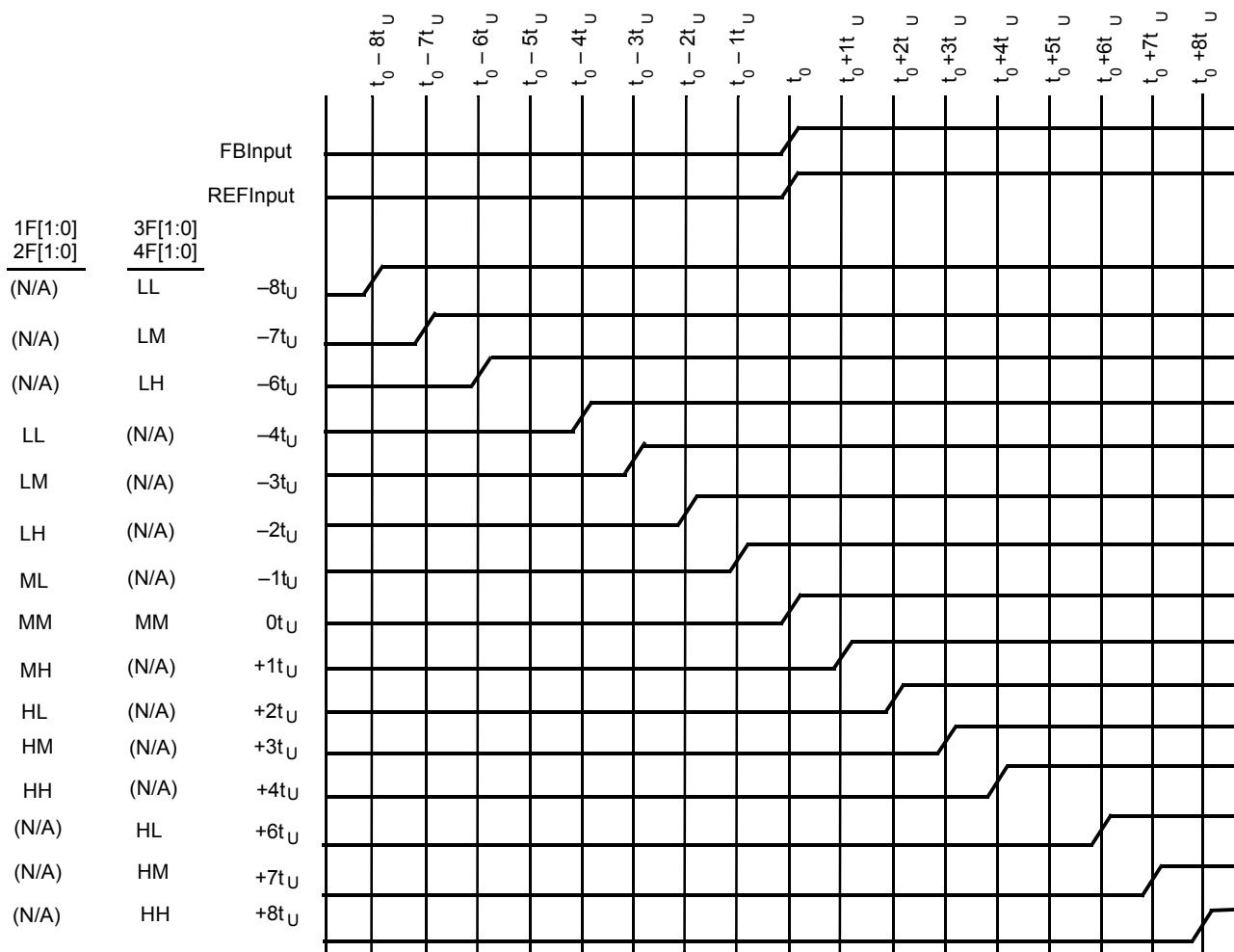

### Output Disable Description

The feedback Divide and Phase Select Matrix Bank has two outputs, and each of the four Divide and Phase Select Matrix Banks have four outputs. The outputs of each bank can be independently put into a HOLD-OFF or high impedance state. The combination of the OUTPUT\_MODE and DIS[1:4]/FBDIS inputs determines the clock outputs' state for each bank. When the DIS[1:4]/FBDIS is LOW, the outputs of the corresponding bank is enabled. When the DIS[1:4]/FBDIS is HIGH, the outputs for that bank is disabled to a high impedance (High Z) or HOLD-OFF state depending on the OUTPUT\_MODE input. Table 5 defines the disabled output functions.

The HOLD-OFF state is intended to be a power saving feature. An output bank is disabled to the HOLD-OFF state in a maximum of six output bank clock cycles from the time when the disable input (DIS[1:4]/FBDIS) is HIGH. When disabled to the HOLD-OFF state, non-inverting outputs are driven to a logic LOW state on

its falling edge. Inverting outputs are driven to a logic HIGH state on its rising edge. This ensures the output clocks are stopped without glitch. When a bank of outputs is disabled to High Z state, the respective bank of outputs go High Z immediately.

Table 5. DIS[1:4]/FBDIS Pin Functionality

OUTPUT_MODE	DIS[1:4]/FBDIS	Output Mode
HIGH/LOW	LOW	ENABLED
HIGH	HIGH	HIGH Z
LOW	HIGH	HOLD-OFF
MID	X	FACTORY TEST

**Note**

4. FB connected to an output selected for "Zero" skew (i.e., FBF0 = MID or XF[1:0] = MID).



### INV3 Pin Function

Bank3 has signal invert capability. The four outputs of Bank3 act as two pairs of complementary outputs when the INV3 pin is driven LOW. In complementary output mode, 3QA0 and 3QB0 are non-inverting; 3QA1 and 3QB1 are inverting outputs. All four outputs are inverted when the INV3 pin is driven HIGH. When the INV3 pin is left in MID, the outputs do not invert. Inversion of the outputs are independent of the skew and divide functions. Therefore, clock outputs of Bank3 can be inverted, divided, and skewed at the same time.

### Lock Detect Output Description

The LOCK detect output indicates the lock condition of the integrated PLL. Lock detection is accomplished by comparing the phase difference between the reference and feedback inputs. Phase error is declared when the phase difference between the two inputs is greater than the specified device propagation delay limit ( $t_{PD}$ ).

When in the locked state, after four or more consecutive feedback clock cycles with phase-errors, the LOCK output is forced LOW to indicate out-of-lock state.

When in the out-of-lock state, 32 consecutive phase-errorless feedback clock cycles are required to allow the LOCK output to indicate lock condition (LOCK = HIGH).

If the feedback clock is removed after LOCK has gone HIGH, a "Watchdog" circuit is implemented to indicate the out-of-lock condition after a time-out period by deasserting LOCK LOW. This time out period is based upon a divided down reference clock.

This assumes that there is activity on the selected REF input. If there is no activity on the selected REF input then the LOCK detect pin may not accurately reflect the state of the internal PLL.

### Factory Test Mode Description

The device enters factory test mode when the OUTPUT\_MODE is driven to MID. In factory test mode, the device operates with its internal PLL disconnected; input level supplied to the reference input is used in place of the PLL output. In TEST mode the selected FB input(s) must be tied LOW. All functions of the device are still operational in factory test mode except the internal PLL and output bank disables. The OUTPUT\_MODE input is designed to be a static input. Dynamically toggling this input from LOW to HIGH may temporarily cause the device to go into factory test mode (when passing through the MID state).

#### Factory Test Reset

When in factory test mode (OUTPUT\_MODE = MID), the device can be reset to a deterministic state by driving the DIS4 input

HIGH. When the DIS4 input is driven HIGH in factory test mode, all clock outputs go to High Z; after the selected reference clock pin has five positive transitions, all the internal finite state machines (FSM) are set to a deterministic state. The deterministic state of the state machines depend on the configurations of the divide selects, skew selects, and frequency select input. All clock outputs stay in high impedance mode and all FSMs stay in the deterministic state until DIS4 is deasserted. When DIS4 is deasserted (with OUTPUT\_MODE still at MID), the device re-enters factory test mode.

### Safe Operating Zone

Figure 4 illustrates the operating condition at which the device does not exceed its allowable maximum junction temperature of 150 °C. Figure 4 shows the maximum number of outputs that can operate at 185 MHz (with 25 pF load and no air flow) or 200 MHz (with 10 pF load and no air flow) at various ambient temperatures. At the limit line, all other outputs are configured to divide-by-two (i.e., operating at 92.5 MHz) or lower frequencies. The device operates below maximum allowable junction temperature of 150 °C when its configuration (with the specified constraints) falls within the shaded region (safe operating zone). Figure 4 shows that at 85 °C, the maximum number of outputs that can operate at 200 MHz is 6; and at 70 °C, the maximum number of outputs that can operate at 185 MHz is 16 (with 25 pF load and 0-m/s air flow).

Figure 4. Typical Safe Operating Zone

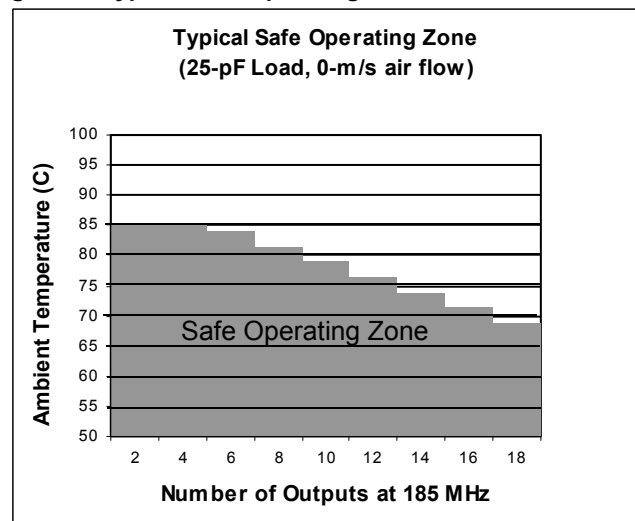

## Absolute Maximum Conditions

Exceeding maximum ratings<sup>[5]</sup> may shorten the useful life of the device. User guidelines are not tested.

Storage Temperature ..... -50 °C to +125 °C

Ambient Temperature  
with Power Applied ..... -40 °C to +125 °C

Supply Voltage to Ground Potential ..... -0.5 V to +4.6 V

DC Input Voltage ..... -0.3 V to  $V_{CC} + 0.5$  V

Output Current into Outputs (LOW) ..... 40 mA

Static Discharge Voltage  
(per MIL-STD-883, Method 3015) ..... > 1100V

Latch up Current ..... >  $\pm 200$  mA

## Operating Range

Range	Ambient Temperature	$V_{CC}$
Commercial	0 °C to +70 °C	3.3 V $\pm$ 10%
Industrial	-40 °C to +85 °C	3.3 V $\pm$ 10%

## Electrical Characteristics

Over the Operating Range

Parameter	Description	Test Conditions	Min	Max	Unit	
<b>LVTTTL Compatible Output Pins (QFA[0:1], [1:4]Q[A:B][0:1], LOCK)</b>						
$V_{OH}$	LVTTTL HIGH Voltage	QFA[0:1], [1:4]Q[A:B][0:1]	$V_{CC} = \text{Min}, I_{OH} = -30$ mA	2.4	-	V
		LOCK	$I_{OH} = -2$ mA, $V_{CC} = \text{Min}$	2.4	-	V
$V_{OL}$	LVTTTL LOW Voltage	QFA[0:1], [1:4]Q[A:B][0:1]	$V_{CC} = \text{Min}, I_{OL} = 30$ mA	-	0.5	V
		LOCK	$I_{OL} = 2$ mA, $V_{CC} = \text{Min}$	-	0.5	V
$I_{OZ}$	High impedance State Leakage Current		-100	100	$\mu$ A	
<b>LVTTTL Compatible Input Pins (FBKA<math>\pm</math>, FBKB<math>\pm</math>, REFA<math>\pm</math>, REFB<math>\pm</math>, FBSEL, REFSEL, FBDIS, DIS[1:4])</b>						
$V_{IH}$	LVTTTL Input HIGH	FBK[A:B] $\pm$ , REF[A:B] $\pm$	$\text{Min} \leq V_{CC} \leq \text{Max}$	2.0	$V_{CC} + 0.3$	V
		REFSEL, FBSEL, FBDIS, DIS[1:4]		2.0	$V_{CC} + 0.3$	V
$V_{IL}$	LVTTTL Input LOW	FBK[A:B] $\pm$ , REF[A:B] $\pm$	$\text{Min} \leq V_{CC} \leq \text{Max}$	-0.3	0.8	V
		REFSEL, FBSEL, FBDIS, DIS[1:4]		-0.3	0.8	V
$I_I$	LVTTTL $V_{IN} > V_{CC}$	FBK[A:B] $\pm$ , REF[A:B] $\pm$	$V_{CC} = \text{GND}, V_{IN} = 3.63$ V	-	100	$\mu$ A
$I_{IH}$	LVTTTL Input HIGH Current	FBK[A:B] $\pm$ , REF[A:B] $\pm$	$V_{CC} = \text{Max}, V_{IN} = V_{CC}$	-	500	$\mu$ A
		REFSEL, FBSEL, FBDIS, DIS[1:4]	$V_{IN} = V_{CC}$	-	500	$\mu$ A
$I_{IL}$	LVTTTL Input LOW Current	FBK[A:B] $\pm$ , REF[A:B] $\pm$	$V_{CC} = \text{Max}, V_{IN} = \text{GND}$	-500	-	$\mu$ A
		REFSEL, FBSEL, FBDIS, DIS[1:4]		-500	-	$\mu$ A
<b>Three-level Input Pins (FBF0, FBDS[0:1], [1:4]F[0:1], [1:4]DS[0:1], FS, OUTPUT_MODE(TEST))</b>						
$V_{IHH}$	Three-level Input HIGH <sup>[6]</sup>		$\text{Min} \leq V_{CC} \leq \text{Max}$	$0.87 \times V_{CC}$	-	V
$V_{IMM}$	Three-level Input MID <sup>[6]</sup>		$\text{Min} \leq V_{CC} \leq \text{Max}$	$0.47 \times V_{CC}$	$0.53 \times V_{CC}$	V
$V_{ILL}$	Three-level Input LOW <sup>[6]</sup>		$\text{Min} \leq V_{CC} \leq \text{Max}$	-	$0.13 \times V_{CC}$	V
$I_{IHH}$	Three-level Input HIGH Current	Three-level input pins excl. FBF0	$V_{IN} = V_{CC}$	-	200	$\mu$ A
		FBF0		-	400	$\mu$ A
$I_{IMM}$	Three-level Input MID Current	Three-level input pins excl. FBF0	$V_{IN} = V_{CC}/2$	-50	50	$\mu$ A
		FBF0		-100	100	$\mu$ A
$I_{ILL}$	Three-level Input LOW Current	Three-level input pins excl. FBF0	$V_{IN} = \text{GND}$	-200	-	$\mu$ A
		FBF0		-400	-	$\mu$ A

### Notes

- Multiple Supplies: The voltage on any input or I/O pin cannot exceed the power pin during power up. Power supply sequencing is NOT required.
- These inputs are normally wired to  $V_{CC}$ , GND, or left unconnected (actual threshold voltages vary as a percentage of  $V_{CC}$ ). Internal termination resistors hold the unconnected inputs at  $V_{CC}/2$ . If these inputs are switched, the function and timing of the outputs may glitch and the PLL may require an additional  $t_{LOCK}$  time before all data sheet limits are achieved.



## Electrical Characteristics (continued)

Over the Operating Range

Parameter	Description		Test Conditions	Min	Max	Unit
<b>LVDIFF Input Pins (FBK[A:B]±, REF[A:B]±)</b>						
V <sub>DIFF</sub>	Input Differential Voltage			400	V <sub>CC</sub>	mV
V <sub>IHHP</sub>	Highest Input HIGH Voltage			1.0	V <sub>CC</sub>	V
V <sub>ILLP</sub>	Lowest Input LOW Voltage			GND	V <sub>CC</sub> - 0.4	V
V <sub>COM</sub>	Common Mode Range (crossing voltage)			0.8	V <sub>CC</sub>	V
<b>Operating Current</b>						
I <sub>CCI</sub>	Internal Operating Current	CY7B993V	V <sub>CC</sub> = Max, f <sub>MAX</sub> <sup>[7]</sup>	–	250	mA
		CY7B994V		–	250	mA
I <sub>CCN</sub>	Output Current Dissipation/Pair <sup>[8]</sup>	CY7B993V	V <sub>CC</sub> = Max, C <sub>LOAD</sub> = 25 pF, R <sub>LOAD</sub> = 50Ω at V <sub>CC</sub> /2, f <sub>MAX</sub>	–	40	mA
		CY7B994V		–	50	mA

### Notes

- I<sub>CCI</sub> measurement is performed with Bank1 and FB Bank configured to run at maximum frequency (f<sub>NOM</sub> = 100 MHz for CY7B993V, f<sub>NOM</sub> = 200 MHz for CY7B994V), and all other clock output banks to run at half the maximum frequency. FS and OUTPUT\_MODE are asserted to the HIGH state.
- This is dependent upon frequency and number of outputs of a bank being loaded. The value indicates maximum I<sub>CCN</sub> at maximum frequency and maximum load of 25 pF terminated to 50Ω at V<sub>CC</sub>/2.

### Capacitance

Parameter	Description	Test Conditions	Min	Max	Unit
C <sub>IN</sub>	Input capacitance	T <sub>A</sub> = 25 °C, f = 1 MHz, V <sub>CC</sub> = 3.3 V	–	5	pF

### Thermal Resistance

Parameter [9]	Description	Test Conditions	100-pin TQFP	100-ball Thin BGA	Unit
θ <sub>JA</sub>	Thermal resistance (junction to ambient)	Test conditions follow standard test methods and procedures for measuring thermal impedance, in accordance with EIA/JESD51.	51	42	°C/W
θ <sub>JC</sub>	Thermal resistance (junction to case)		11	16	°C/W

### AC Test Loads and Waveforms

Figure 5. AC Test Loads and Waveforms [10]

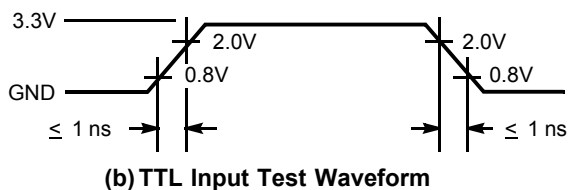
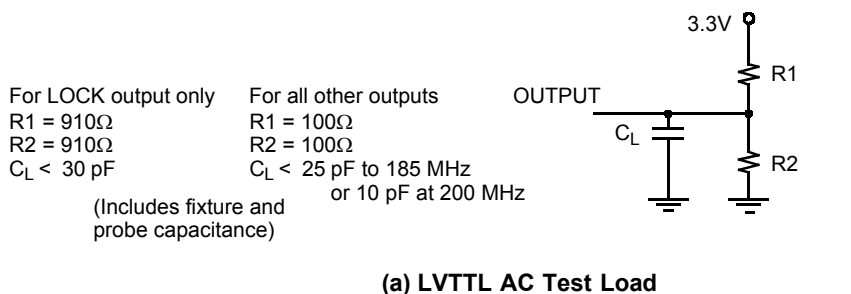

**Notes**

- 9. These parameters are guaranteed by design and are not tested.
- 10. These figures are for illustrations only. The actual ATE loads may vary.



## Switching Characteristics

Over the Operating Range [11, 12, 13, 14, 15]

Parameter	Description	CY7B993/4V-2			CY7B993/4V-5			Unit	
		Min	Typ	Max	Min	Typ	Max		
f <sub>IN</sub>	Clock Input Frequency	CY7B993V	12	–	100	12	–	100	MHz
		CY7B994V	24	–	200	24	–	200	MHz
f <sub>OUT</sub>	Clock Output Frequency	CY7B993V	12	–	100	12	–	100	MHz
		CY7B994V	24	–	200	24	–	200	MHz
t <sub>SKEWPR</sub>	Matched-Pair Skew [16, 17]	–	–	200	–	–	200	ps	
t <sub>SKEWBNK</sub>	Intrabank Skew [16, 17]	–	–	200	–	–	250	ps	
t <sub>SKEW0</sub>	Output-Output Skew (same frequency and phase, rise to rise, fall to fall) [16, 17]	–	–	250	–	–	550	ps	
t <sub>SKEW1</sub>	Output-Output Skew (same frequency and phase, other banks at different frequency, rise to rise, fall to fall) [16, 17]	–	–	250	–	–	650	ps	
t <sub>SKEW2</sub>	Output-Output Skew (invert to nominal of different banks, compared banks at same frequency, rising edge to falling edge aligned, other banks at same frequency) [16, 17]	–	–	250	–	–	700	ps	
t <sub>SKEW3</sub>	Output-Output Skew (all output configurations outside of t <sub>SKEW1</sub> and t <sub>SKEW2</sub> ) [16, 17]	–	–	500	–	–	800	ps	
t <sub>SKEWCPR</sub>	Complementary Outputs Skew (crossing to crossing, complementary outputs of the same bank) [16, 17, 18, 19]	–	–	200	–	–	300	ps	
t <sub>CCJ1-3</sub>	Cycle-to-Cycle Jitter (divide by 1 output frequency, FB = divide by 1, 2, 3)	–	50	150	–	50	150	ps Peak	
t <sub>CCJ4-12</sub>	Cycle-to-Cycle Jitter (divide by 1 output frequency, FB = divide by 4, 5, 6, 8, 10, 12)	–	50	100	–	50	100	ps Peak	
t <sub>PD</sub>	Propagation Delay, REF to FB Rise	–250	–	250	–500	–	500	ps	

### Notes

11. This is for non-three level inputs.
12. Assumes 25 pF Max load capacitance up to 185 MHz. At 200 MHz the Max load is 10 pF.
13. Both outputs of pair must be terminated, even if only one is being used.
14. Each package must be properly decoupled.
15. AC parameters are measured at 1.5V unless otherwise indicated.
16. Test Load C<sub>L</sub> = 25 pF, terminated to V<sub>CC</sub>/2 with 50Ω up to 185 MHz and 10 pF load to 200 MHz.
17. SKEW is defined as the time between the earliest and the latest output transition among all outputs for which the same phase delay has been selected when all outputs are loaded with 25 pF and properly terminated up to 185 MHz. At 200 MHz the max load is 10 pF.
18. Complementary output skews are measured at complementary signal pair intersections.
19. Guaranteed by statistical correlation. Tested initially and after any design or process changes that may affect these parameters.



## Switching Characteristics (continued)

Over the Operating Range [11, 12, 13, 14, 15]

Parameter	Description	CY7B993/4V-2			CY7B993/4V-5			Unit
		Min	Typ	Max	Min	Typ	Max	
TTB	Total Timing Budget window (same frequency and phase) <sup>[19, 20]</sup>	–	–	500	–	–	700	ps
t <sub>PDELTA</sub>	Propagation Delay difference between two devices <sup>[19]</sup>	–	–	200	–	–	200	ps
t <sub>REFpwh</sub>	REF input (Pulse Width HIGH) <sup>[21]</sup>	2.0	–	–	2.0	–	–	ns
t <sub>REFpwl</sub>	REF input (Pulse Width LOW) <sup>[21]</sup>	2.0	–	–	2.0	–	–	ns
t <sub>r</sub> /t <sub>f</sub>	Output Rise/Fall Time <sup>[22]</sup>	0.15	–	2.0	0.15	–	2.0	ns
t <sub>LOCK</sub>	PLL Lock Time from Power up	–	–	10	–	–	10	ms
t <sub>RELOCK1</sub>	PLL Relock Time (from same frequency, different phase) with Stable Power Supply	–	–	500	–	–	500	μs
t <sub>RELOCK2</sub>	PLL Relock Time (from different frequency, different phase) with Stable Power Supply <sup>[23]</sup>	–	–	1000	–	–	1000	μs
t <sub>ODCV</sub>	Output duty cycle deviation from 50% <sup>[24]</sup>	–1.0	–	1.0	–1.0	–	1.0	ns
t <sub>PWH</sub>	Output HIGH time deviation from 50% <sup>[25]</sup>	–	–	1.5	–	–	1.5	ns
t <sub>PWL</sub>	Output LOW time deviation from 50% <sup>[25]</sup>	–	–	2.0	–	–	2.0	ns
t <sub>PDEV</sub>	Period deviation when changing from reference to reference <sup>[26]</sup>	–	–	0.025	–	–	0.025	UI
t <sub>OAZ</sub>	DIS[1:4]/FBDIS HIGH to output high impedance from ACTIVE <sup>[27, 28]</sup>	1.0	–	10	1.0	–	10	ns
t <sub>OAZ</sub>	DIS[1:4]/FBDIS LOW to output ACTIVE from output high impedance <sup>[28, 29]</sup>	0.5	–	14	0.5	–	14	ns

### Notes

20. TTB is the window between the earliest and the latest output clocks with respect to the input reference clock across variations in output frequency, supply voltage, operating temperature, input clock edge rate, and process. The measurements are taken with the AC test load specified and include output-output skew, cycle-cycle jitter, and dynamic phase error. TTB is equal to or smaller than the maximum specified value at a given frequency.

21. Tested initially and after any design or process changes that may affect these parameters.

22. Rise and fall times are measured between 2.0V and 0.8V.

23. f<sub>NOM</sub> must be within the frequency range defined by the same FS state.

24. AC parameters are measured at 1.5V unless otherwise indicated.

25. t<sub>PWH</sub> is measured at 2.0V. t<sub>PWL</sub> is measured at 0.8V.

26. UI = Unit Interval. Examples: 1 UI is a full period. 0.1UI is 10% of period.

27. Test Load C<sub>L</sub> = 25 pF, terminated to V<sub>CC</sub>/2 with 50Ω up to 185 MHz and 10 pF load to 200 MHz.

28. Measured at 0.5V deviation from starting voltage.

29. For t<sub>OZA</sub> minimum, C<sub>L</sub> = 0 pF. For t<sub>OZA</sub> maximum, C<sub>L</sub> = 25 pF to 185 MHz or 10 pF to 200 MHz.

AC Timing Diagrams

Figure 6. AC Timing Diagrams [30]

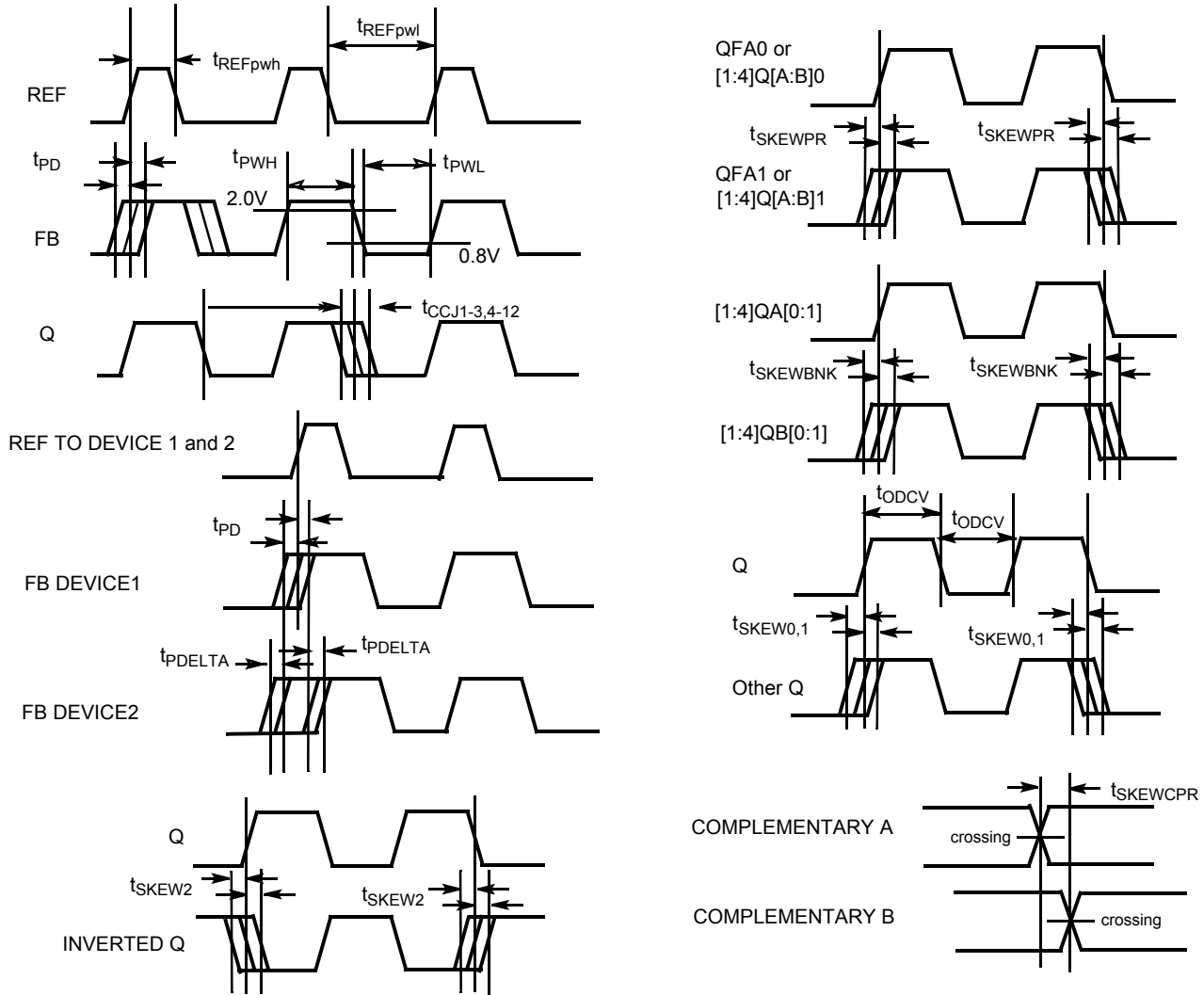

**Note**  
30. AC parameters are measured at 1.5V unless otherwise indicated.



## Ordering Information

Propagation Delay (ps)	Max Speed (MHz)	Ordering Code	Package Type	Operating Range
250	200	CY7B994V-2BBI	100-ball Thin BGA	Industrial, -40 °C to 85 °C
250	200	CY7B994V-2BBIT	100-ball Thin BGA – Tape and Reel	Industrial, -40 °C to 85 °C
500	200	CY7B994V-5BBC	100-ball Thin BGA	Commercial, 0 °C to 70 °C
500	200	CY7B994V-5BBCT	100-ball Thin BGA – Tape and Reel	Commercial, 0 °C to 70 °C
<b>Pb-free</b>				
250	100	CY7B993V-2AXC	100-pin TQFP	Commercial, 0 °C to 70 °C
250	100	CY7B993V-2AXCT	100-pin TQFP – Tape and Reel	Commercial, 0 °C to 70 °C
250	100	CY7B993V-2AXI	100-pin TQFP	Industrial, -40 °C to 85 °C
250	200	CY7B994V-2AXC	100-pin TQFP	Commercial, 0 °C to 70 °C
250	200	CY7B994V-2AXCT	100-pin TQFP – Tape and Reel	Commercial, 0 °C to 70 °C
250	200	CY7B994V-2AXI	100-pin TQFP	Industrial, -40 °C to 85 °C
250	200	CY7B994V-2AXIT	100-pin TQFP – Tape and Reel	Industrial, -40 °C to 85 °C
250	200	CY7B994V-2BBXI	100-ball Thin BGA	Industrial, -40 °C to 85 °C
250	200	CY7B994V-2BBXIT	100-ball Thin BGA – Tape and Reel	Industrial, -40 °C to 85 °C
500	100	CY7B993V-5AXC	100-pin TQFP	Commercial, 0 °C to 70 °C
500	100	CY7B993V-5AXCT	100-pin TQFP – Tape and Reel	Commercial, 0 °C to 70 °C
500	100	CY7B993V-5AXI	100-pin TQFP	Industrial, -40 °C to 85 °C
500	100	CY7B993V-5AXIT	100-pin TQFP – Tape and Reel	Industrial, -40 °C to 85 °C
500	200	CY7B994V-5AXC	100-pin TQFP	Commercial, 0 °C to 70 °C
500	200	CY7B994V-5AXCT	100-pin TQFP – Tape and Reel	Commercial, 0 °C to 70 °C
500	200	CY7B994V-5BBXI	100-ball Thin BGA	Industrial, -40 °C to 85 °C
500	200	CY7B994V-5BBXIT	100-ball Thin BGA – Tape and Reel	Industrial, -40 °C to 85 °C
500	200	CY7B994V-5AXI	100-pin TQFP	Industrial, -40 °C to 85 °C
500	200	CY7B994V-5AXIT	100-pin TQFP – Tape and Reel	Industrial, -40 °C to 85 °C

## Ordering Code Definitions

CY 7B99XV - X XX X X X

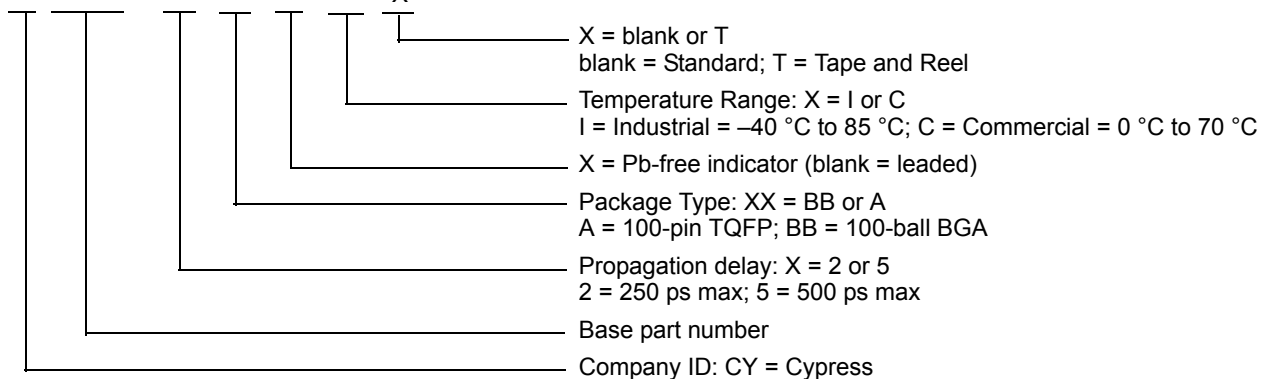

Package Diagrams

Figure 7. 100-pin TQFP (14 × 14 × 1.4 mm) A100SA Package Outline, 51-85048

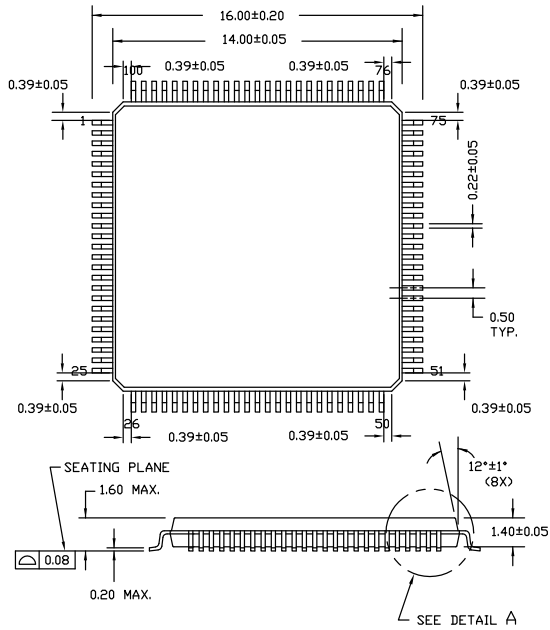

NOTE:

1. JEDEC STD REF MS-026
2. BODY LENGTH DIMENSION DOES NOT INCLUDE MOLD PROTRUSION/END FLASH  
MOLD PROTRUSION/END FLASH SHALL NOT EXCEED 0.0098 in (0.25 mm) PER SIDE  
BODY LENGTH DIMENSIONS ARE MAX PLASTIC BODY SIZE INCLUDING MOLD MISMATCH
3. DIMENSIONS IN MILLIMETERS

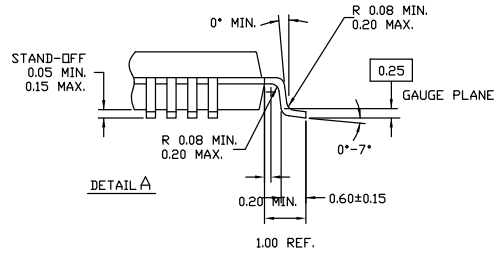

NOTE: PKG. CAN HAVE

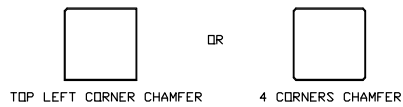

51-85048 \*J

Package Diagrams (continued)

Figure 8. 100-ball Thin BGA (11 × 11 × 1.4 mm) BB100 Package Outline, 51-85107

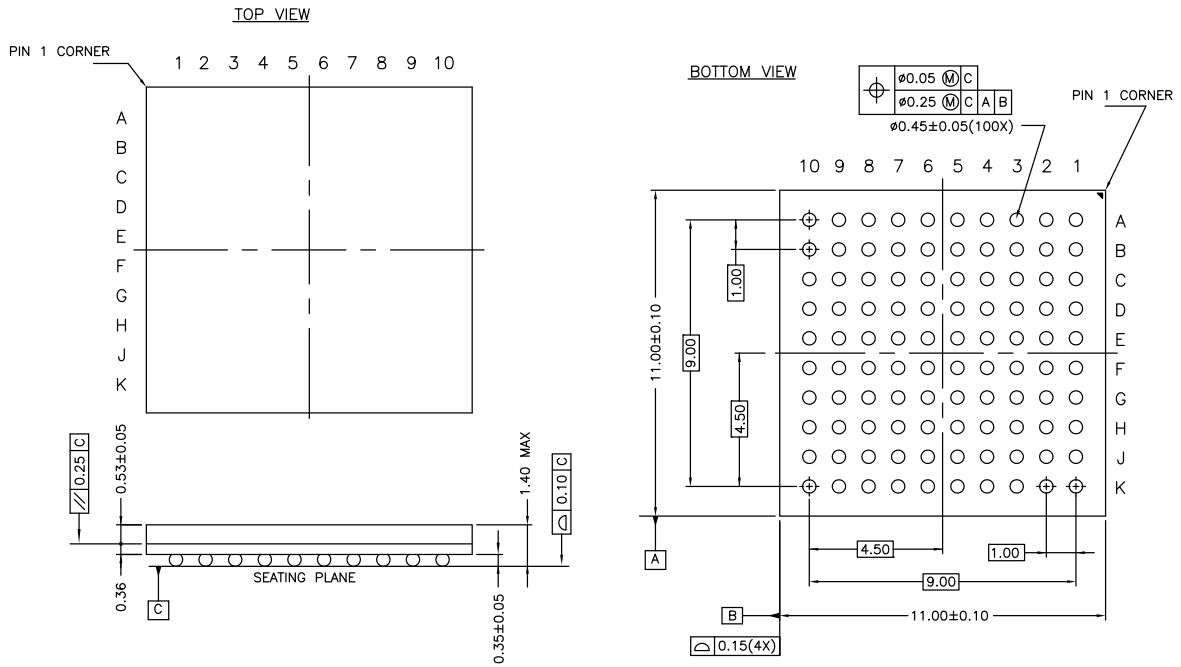

51-85107 \*E



## Acronyms

Acronym	Description
BGA	Ball Grid Array
FS	Frequency Select
I/O	Input/Output
LVPECL	Low Voltage Positive Emitter Coupled Logic
LVTTL	Low Voltage Transistor-Transistor Logic
PLL	Phase-Locked Loop
TQFP	Thin Quad Flat Pack
TTL	Transistor-Transistor Logic
VCO	Voltage Controlled Oscillator

## Document Conventions

### Units of Measure

Symbol	Unit of Measure
°C	degree Celsius
KHz	kilohertz
KΩ	kilohm
MHz	megahertz
μA	microampere
mA	milliampere
ms	millisecond
mV	millivolt
ns	nanosecond
Ω	ohm
%	percent
pF	picofarad
ps	picosecond
V	volt
W	watt



## Document History Page

Document Title: CY7B993V/CY7B994V RoboClock®, High-Speed Multi-Phase PLL Clock Buffer Document Number: 38-07127				
Revision	ECN	Orig. of Change	Submission Date	Description of Change
**	109957	SZV	12/16/01	Changed from Spec number: 38-00747 to 38-07127
*A	114376	CTK	05/06/02	Updated <a href="#">Ordering Information</a> : Updated part numbers.
*B	116570	HWT	09/04/02	Updated <a href="#">Switching Characteristics</a> : Added TTB parameter and its details.
*C	122794	RBI	12/14/02	Updated <a href="#">Absolute Maximum Conditions</a> : Added Note 5 and referred the same note next to “maximum ratings” in the description below heading.
*D	123694	RGL	03/04/03	Updated <a href="#">Block Diagram Description</a> : Updated <a href="#">Lock Detect Output Description</a> : Replaced “(t <sub>PDSL</sub> , M, H)” with “(t <sub>PD</sub> )”. Updated <a href="#">Switching Characteristics</a> : Added minimum value of F <sub>out</sub> parameter.
*E	128462	RGL	07/29/03	Updated <a href="#">Switching Characteristics</a> : Added f <sub>in</sub> parameter and its details.
*F	391560	RGL	See ECN	Updated <a href="#">Features</a> : Replaced “Low cycle-to-cycle jitter (< 100-ps peak-peak)” with “<50-ps typical cycle-to-cycle jitter”. Updated <a href="#">Switching Characteristics</a> : Added a column “Typ” under “CY7B993/4V-2” and “CY7B993/4V-5”. Included values in “Typ” column for t <sub>CCJ1-3</sub> and t <sub>CCJ4-12</sub> parameters. Updated <a href="#">Ordering Information</a> : Updated part numbers.
*G	2896548	KVM	03/19/10	Updated <a href="#">Ordering Information</a> : Updated part numbers. Replaced “Lead-Free” with “Pb-Free”. Replaced “Commercial” with “Commercial, 0 °C to 70 °C” in “Operating Range” column. Replaced “Industrial” with “Industrial, -40 °C to 85 °C” in “Operating Range” column.
*H	3055192	CXQ	10/11/2010	Updated <a href="#">Ordering Information</a> : Updated part numbers. Added <a href="#">Ordering Code Definitions</a> .
*I	3076912	CXQ	11/02/2010	Updated <a href="#">Ordering Information</a> : No change in part numbers. Updated <a href="#">Ordering Code Definitions</a> .
*J	3240908	CXQ	04/26/2011	Updated <a href="#">Absolute Maximum Conditions</a> : Changed value of “Storage Temperature” from “-40 °C to +125 °C” to “-50 °C to +125 °C”. Updated <a href="#">Package Diagrams</a> : spec 51-85048 – Changed revision from *D to *E.
*K	4196053	CINM	11/19/2013	Updated <a href="#">Package Diagrams</a> : spec 51-85048 – Changed revision from *E to *H. spec 51-85107 – Changed revision from *C to *E. Added <a href="#">Acronyms</a> and <a href="#">Units of Measure</a> . Updated to new template. Completing Sunset Review.



## Document History Page (continued)

Document Title: CY7B993V/CY7B994V RoboClock®, High-Speed Multi-Phase PLL Clock Buffer Document Number: 38-07127				
Revision	ECN	Orig. of Change	Submission Date	Description of Change
*L	4570131	CINM	11/14/2014	Updated <a href="#">Functional Description</a> : Added "For a complete list of related documentation, <a href="#">click here.</a> " at the end. Updated <a href="#">Ordering Information</a> : Updated part numbers. Updated <a href="#">Package Diagrams</a> : spec 51-85048 – Changed revision from *H to *I.
*M	5257270	PSR	05/03/2016	Added <a href="#">Thermal Resistance</a> . Updated <a href="#">Package Diagrams</a> : spec 51-85048 – Changed revision from *I to *J. Updated to new template.
*N	5528003	XHT	11/21/2016	Updated to new template. Completing Sunset Review.
*O	5977219	AESATMP8	11/27/2017	Updated logo and Copyright.



## Sales, Solutions, and Legal Information

### Worldwide Sales and Design Support

Cypress maintains a worldwide network of offices, solution centers, manufacturer's representatives, and distributors. To find the office closest to you, visit us at [Cypress Locations](#).

#### Products

ARM <sup>®</sup> Cortex <sup>®</sup> Microcontrollers	<a href="http://cypress.com/arm">cypress.com/arm</a>
Automotive	<a href="http://cypress.com/automotive">cypress.com/automotive</a>
Clocks & Buffers	<a href="http://cypress.com/clocks">cypress.com/clocks</a>
Interface	<a href="http://cypress.com/interface">cypress.com/interface</a>
Internet of Things	<a href="http://cypress.com/iot">cypress.com/iot</a>
Memory	<a href="http://cypress.com/memory">cypress.com/memory</a>
Microcontrollers	<a href="http://cypress.com/mcu">cypress.com/mcu</a>
PSoC	<a href="http://cypress.com/psoc">cypress.com/psoc</a>
Power Management ICs	<a href="http://cypress.com/pmic">cypress.com/pmic</a>
Touch Sensing	<a href="http://cypress.com/touch">cypress.com/touch</a>
USB Controllers	<a href="http://cypress.com/usb">cypress.com/usb</a>
Wireless Connectivity	<a href="http://cypress.com/wireless">cypress.com/wireless</a>

#### PSoC<sup>®</sup> Solutions

[PSoC 1](#) | [PSoC 3](#) | [PSoC 4](#) | [PSoC 5LP](#) | [PSoC 6](#)

#### Cypress Developer Community

[Forums](#) | [WICED IOT Forums](#) | [Projects](#) | [Video](#) | [Blogs](#) | [Training](#) | [Components](#)

#### Technical Support

[cypress.com/support](http://cypress.com/support)



© Cypress Semiconductor Corporation, 2001-2017. This document is the property of Cypress Semiconductor Corporation and its subsidiaries, including Spansion LLC ("Cypress"). This document, including any software or firmware included or referenced in this document ("Software"), is owned by Cypress under the intellectual property laws and treaties of the United States and other countries worldwide. Cypress reserves all rights under such laws and treaties and does not, except as specifically stated in this paragraph, grant any license under its patents, copyrights, trademarks, or other intellectual property rights. If the Software is not accompanied by a license agreement and you do not otherwise have a written agreement with Cypress governing the use of the Software, then Cypress hereby grants you a personal, non-exclusive, nontransferable license (without the right to sublicense) (1) under its copyright rights in the Software (a) for Software provided in source code form, to modify and reproduce the Software solely for use with Cypress hardware products, only internally within your organization, and (b) to distribute the Software in binary code form externally to end users (either directly or indirectly through resellers and distributors), solely for use on Cypress hardware product units, and (2) under those claims of Cypress's patents that are infringed by the Software (as provided by Cypress, unmodified) to make, use, distribute, and import the Software solely for use with Cypress hardware products. Any other use, reproduction, modification, translation, or compilation of the Software is prohibited.

TO THE EXTENT PERMITTED BY APPLICABLE LAW, CYPRESS MAKES NO WARRANTY OF ANY KIND, EXPRESS OR IMPLIED, WITH REGARD TO THIS DOCUMENT OR ANY SOFTWARE OR ACCOMPANYING HARDWARE, INCLUDING, BUT NOT LIMITED TO, THE IMPLIED WARRANTIES OF MERCHANTABILITY AND FITNESS FOR A PARTICULAR PURPOSE. To the extent permitted by applicable law, Cypress reserves the right to make changes to this document without further notice. Cypress does not assume any liability arising out of the application or use of any product or circuit described in this document. Any information provided in this document, including any sample design information or programming code, is provided only for reference purposes. It is the responsibility of the user of this document to properly design, program, and test the functionality and safety of any application made of this information and any resulting product. Cypress products are not designed, intended, or authorized for use as critical components in systems designed or intended for the operation of weapons, weapons systems, nuclear installations, life-support devices or systems, other medical devices or systems (including resuscitation equipment and surgical implants), pollution control or hazardous substances management, or other uses where the failure of the device or system could cause personal injury, death, or property damage ("Unintended Uses"). A critical component is any component of a device or system whose failure to perform can be reasonably expected to cause the failure of the device or system, or to affect its safety or effectiveness. Cypress is not liable, in whole or in part, and you shall and hereby do release Cypress from any claim, damage, or other liability arising from or related to all Unintended Uses of Cypress products. You shall indemnify and hold Cypress harmless from and against all claims, costs, damages, and other liabilities, including claims for personal injury or death, arising from or related to any Unintended Uses of Cypress products.

Cypress, the Cypress logo, Spansion, the Spansion logo, and combinations thereof, WICED, PSoC, CapSense, EZ-USB, F-RAM, and Traveo are trademarks or registered trademarks of Cypress in the United States and other countries. For a more complete list of Cypress trademarks, visit [cypress.com](http://cypress.com). Other names and brands may be claimed as property of their respective owners.

## Looking for pricing, stock, or lifecycle information?

Click below to explore more details on WIN SOURCE:

-  [View CY7B994V-2AXC on WIN SOURCE](#)
-  [Cypress Semiconductor Corp Information](#)

## Optimize Your Supply Chain with WIN SOURCE Solutions

-  Global Sourcing Solution
-  Obsolete Management
-  Cost Control Management
-  Shortage Management
-  Alternative Solution
-  Excess Inventory Management