



**THE DATASHEET OF  
SIP4613BDVP-T1-E3**





## Protected 1-A High-Side Load Switch

### DESCRIPTION

SiP4613A, SiP4613B is a protected highside power switch. It is designed to operate from voltages ranging from 2.4 V to 5.5 V and handle a continuous current of 1 A. The user settable current limit protects the input supply voltage from excessive load currents that might cause a system failure.

SiP4613A, SiP4613B has a low shutdown supply current, which is reduced to less than 1  $\mu$ A. A flag output  $\bar{C}_L$  is available to indicate fault conditions such as output short and thermal protection.

In addition to current limit, the SiP4613A, SiP4613B is protected by undervoltage lockout and thermal shutdown.

The SiP4613A, SiP4613B is available in a lead (Pb)-free 6-pin PowerPAK<sup>®</sup> TSC75-6 for operation over the industrial temperature range of - 40 °C to 85 °C.

### FEATURES

- 1 A continuous output current
- 2.4 V to 5.5 V supply voltage range
- User settable current limit level
- Low quiescent current
- Undervoltage lockout
- Thermal shutdown protection
- 4 kV ESD rating-HBM

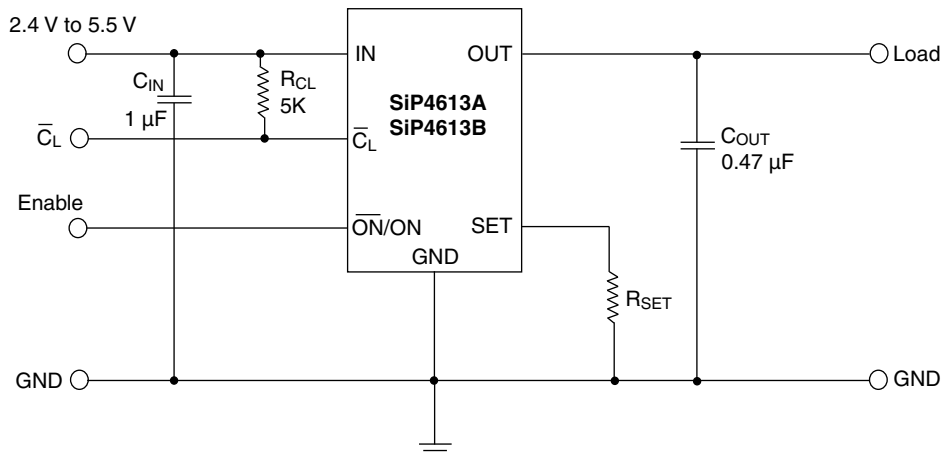


RoHS  
COMPLIANT

### APPLICATIONS

- Peripheral ports
- Hot swap
- Notebook computers
- PDAs

### TYPICAL APPLICATION CIRCUIT



| <b>ABSOLUTE MAXIMUM RATINGS</b> all voltages referenced to GND = 0 V |             |      |
|--|-------------|------|
| Parameter  | Limit       | Unit |
| $V_{IN}, V_{\overline{ON}}, V_{ON}$                                  | - 0.3 to 6  | V    |
| $I_{MAX}$  | 2           | A    |
| Storage Temperature  | - 65 to 150 | °C   |
| Operating Junction Temperature                                       | - 40 to 150 | °C   |
| Power Dissipation <sup>a</sup> , PowerPAK TSC75-6                    | 420         | mW   |
| Thermal Impedance ( $\Theta_{JA}$ ) <sup>b</sup> , PowerPAK TSC75-6  | 131         | °C/W |

Notes:

a. Derate 7.6 mW/°C above  $T_A = 70$  °C.

b. Device mounted with all leads soldered or welded to PC board.

Stresses beyond those listed under "Absolute Maximum Ratings" may cause permanent damage to the device. These are stress ratings only, and functional operation of the device at these or any other conditions beyond those indicated in the operational sections of the specifications is not implied. Exposure to absolute maximum rating conditions for extended periods may affect device reliability.

| <b>RECOMMENDED OPERATING RANGE</b> all voltages referenced to GND = 0 V |            |      |
|---|------------|------|
| Parameter   | Limit      | Unit |
| IN  | 2.4 to 5.5 | V    |
| Operating Temperature Range   | - 40 to 85 | °C   |

| <b>SPECIFICATIONS<sup>a</sup></b>  |              |   |                   |                   |                   |                  |
|------------------------------------|--------------|---|-------------------|-------------------|-------------------|------------------|
| Parameter                          | Symbol       | Test Conditions Unless Specified<br>IN = 5 V, $T_A = -40$ °C to 85 °C           | Limits            |                   |                   | Unit             |
|                                    |              |   | Min. <sup>a</sup> | Typ. <sup>b</sup> | Max. <sup>a</sup> |                  |
| <b>Power Supplies</b>              |              |   |                   |                   |                   |                  |
| Supply Voltage                     | $V_{IN}$     |   | 2.4               |                   | 5.5               | V                |
| Quiescent Current                  | $I_Q$        | IN = 5 V, $\overline{ON}/ON = \text{Active}$ , $I_{OUT} = 0$ A                  |                   |                   | 100               | $\mu\text{A}$    |
| Shutdown Current                   | $I_{SD}$     | IN = 5 V, $\overline{ON}/ON = \text{Inactive}$                                  |                   |                   | 1                 |                  |
| Switch Off Current                 | $I_{S(off)}$ | IN = 5 V, $\overline{ON}/ON = \text{Inactive}$ , $V_{OUT} = 0$ V, $T_A = 25$ °C |                   |                   | 1                 |                  |
| <b>Enable Inputs</b>               |              |   |                   |                   |                   |                  |
| $\overline{ON}/ON$ High            | $V_{IH}$     | IN = 2.4 V to 5.5 V   | 1.5               |                   |                   | V                |
| $\overline{ON}/ON$ Low             | $V_{IL}$     |   |                   |                   | 0.5               |                  |
| $\overline{ON}/ON$ Leakage Current | $I_{LH}$     | $\overline{ON}/ON = 5$ V  |                   |                   | 1                 | $\mu\text{A}$    |
| Turn Off Time                      | $t_{OFF}$    | IN = 5 V, $R_L = 10$ $\Omega$   |                   | 0.5               | 5                 | $\mu\text{s}$    |
| Turn On Time                       | $t_{ON}$     |   |                   | 55                | 120               |                  |
| <b>Output</b>                      |              |   |                   |                   |                   |                  |
| On-Resistance                      | $R_{DS}$     | IN = 5 V, $T_A = 25$ °C   |                   | 150               | 225               | $\text{m}\Omega$ |
|                                    |              | IN = 3 V, $T_A = 25$ °C   |                   | 180               | 250               |                  |
| Current Limit                      | $I_L$        | $R_{SET} = 6.81$ k $\Omega$   | 0.375             | 0.5               | 0.625             | A                |
| Minimum Current Limit              | $I_{L(min)}$ |   |                   | 125               |                   | $\text{mA}$      |
| Output Short Circuit Current       | $I_{SH}$     | $R_{SET} = 6.81$ k $\Omega$   | 0.350             | 0.5               | 0.650             | A                |
| Current Limit Response Time        | $t_{RESP}$   | IN = 5 V  |                   | 4                 |                   | $\mu\text{s}$    |
| <b>Undervoltage Lockout</b>        |              |   |                   |                   |                   |                  |
| UVLO Threshold                     | $V_{UVLO}$   | Rising Edge   |                   | 1.8               | 2.4               | V                |
| UVLO Hysteresis                    | $V_{HYST}$   |   |                   | 0.05              |                   |                  |
| <b>Thermal Shutdown</b>            |              |   |                   |                   |                   |                  |
| Thermal Shutdown Threshold         | T            |   |                   |                   | 165               | °C               |
| Hysteresis                         | $T_{HYST}$   |   |                   | 20                |                   |                  |

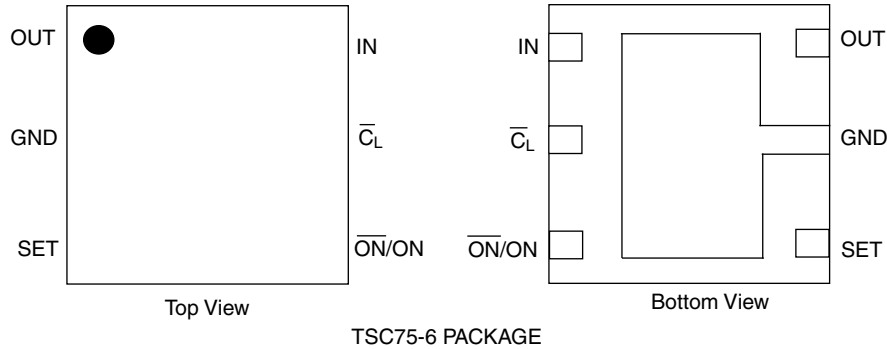
Notes:

a. The algebraic convention whereby the most negative value is a minimum and the most positive a maximum (- 40 °C to 85 °C).

b. Typical values are for DESIGN AID ONLY, not guaranteed nor subject to production testing.

c. Guaranteed by design.

**PIN CONFIGURATION, ORDERING INFORMATION**



| ORDERING INFORMATION |         |                   |                  |
|----------------------|---------|-------------------|------------------|
| Part Number          | Marking | Temperature Range | Package          |
| SiP4613ADVP-T1-E3    | M3XXX   | - 40 °C to 85 °C  | PowerPAK TSC75-6 |
| SiP4613BDVP-T1-E3    | M4XXX   | - 40 °C to 85 °C  | PowerPAK TSC75-6 |

XX = Lot Code  
W = Work week Code

| PIN DESCRIPTION |                                  |  |
|-----------------|----------------------------------|--|
| Pin Number      | Name                             | Function   |
| 1               | OUT                              | Switch output  |
| 2               | GND                              | Ground pin   |
| 3               | SET                              | Current limit level set pin. The level is determined by the value of a resistor connected from this pin to GND   |
| 4               | $\overline{\text{ON/ON}}$        | Shutdown pin. $\overline{\text{ON/ON}}$ , active low on the SiP4613A to turn on the switch, active high to turn off SiP4613A<br>Active high on the SiP4613B to turn on the switch, active low to turn off SiP4613B |
| 5               | $\overline{\text{C}}_{\text{L}}$ | $\overline{\text{C}}_{\text{L}}$ pin will go low if SiP4613 is operating in current limited condition  |
| 6               | IN                               | Input supply voltage and switch input  |

**FUNCTIONAL BLOCK DIAGRAM**

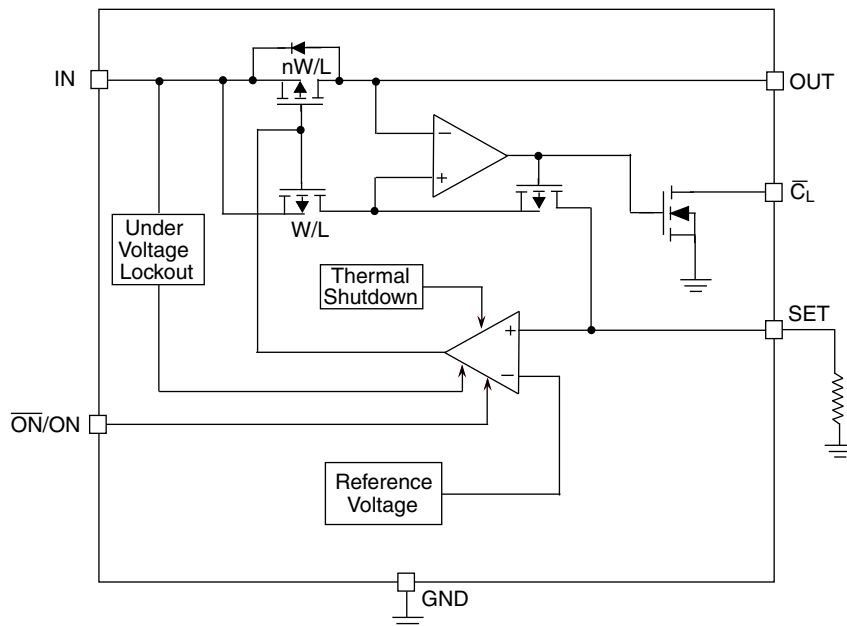


Figure 1. SiP4613A/B Block Diagram

### DETAILED DESCRIPTION

The SiP4613A, SiP4613B limits load current by sampling the pass transistor current and passing that through an external resistor,  $R_{SET}$ . The voltage across  $R_{SET}$ ,  $V_{SET}$ , is then compared with an internal reference voltage,  $V_{REF}$ . In the event that load current surpasses the set limit current,  $V_{SET}$  will exceed  $V_{REF}$  causing the pass transistor gate voltage to increase, thereby reducing the gate to source voltage of the PMOS switch and regulating its current back down to  $I_{LIMIT}$ .

### Setting the Current Limit Level

Setting the current limit level on the SiP4613A, SiP4613B requires some care to ensure the maximum current required by the load will not trigger the current limit circuitry. The minimum current limit threshold should be determined by taking the maximum current required by the load,  $I_{LOAD}$ , and adding 25 % headroom. The SiP4613A, SiP4613B has a current limit tolerance of 25 %, which is largely a result of process variations from part to part, and also temperature and  $V_{IN}/V_{OUT}$  variances. Thus, to ensure that the actual current limit is never below the desired current limit a 1/0.80 = 1.25 coefficient needs to be added to the calculations. Knowing the maximum load current required, the value of  $R_{SET}$  is calculated as follows.

$$R_{SET} = R_{SET \text{ coefficient}} / I_{LIMIT}$$

where  $I_{LIMIT} = (I_{LOAD} \times 1.25) \times 1.20$  and  $R_{SET}$  coefficient is 3460 for a 500 mA current limit. For typical  $R_{SET}$  coefficient values given a limit current refer to the "Typical Characteristics" section.

### Operation at Current Limit and Thermal Shutdown

In the event that a load higher than  $I_{LIMIT}$  is demanded of the SiP4613A, SiP4613B the load current will stay fixed at the current limit established by  $R_{SET}$ . However, since the required current is not supplied, the voltage at OUT will drop. The increase in  $V_{IN} - V_{OUT}$  will cause the chip to dissipate more heat. The power dissipation for the SiP4613A, SiP4613B can be expressed as

$$P = I_{LOAD} \times (V_{IN} - V_{OUT})$$

Once this exceeds the maximum power dissipation of the package, the die temperature will rise. When the die temperature exceeds an over-temperature limit of 165 °C, the SiP4613A, SiP4613B will shut down until it has cooled down to 145 °C, before starting up again. As can be seen in the figure below, the SiP4613A, SiP4613B will continue to cycle on and off until the load is reduced or the part is turned off (see figure 4 on next page).

The maximum power dissipation in any application is dependant on the maximum junction temperature,  $T_{J(MAX)} = 125$  °C, the junction-to-ambient thermal resistance for the TSC75-6 package,  $\theta_{J-A} = 131$  °C/W, and the ambient temperature,  $T_A$ , which may be formulaically expressed as:

$$P(max) = \frac{T_J(max) - T_A}{\theta_{J-A}} = \frac{125 - T_A}{131}$$

It then follows that assuming an ambient temperature of 70 °C, the maximum power dissipation will be limited to about 419 mW.

There is  $\overline{CL}$  pin designed to indicate the current limit status of SiP4613. A typical 5 k $\Omega$  resistor is required to connect between  $\overline{CL}$  pin and IN pin. In the event of the output over load, the current limit flag pin  $\overline{CL}$  will go low to indicate the current limit status of the device. Figure 2 shows the voltage on  $\overline{CL}$  pin go low after output short.

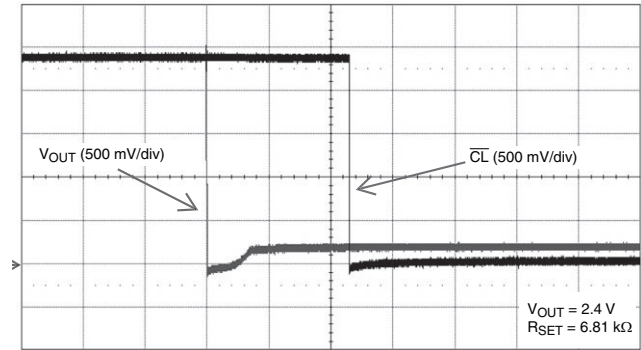


Figure 2

The voltage signal in  $\overline{CL}$  pin is not only used to indicate the output short circuit status. It is also used to indicate the thermal protection status of the device. Once the thermal protection is activated in the severe output short circuit condition, the voltage signal on the  $\overline{CL}$  pin will run into the thermal protection cycling. Figure 3 shows the voltage waveform of  $\overline{CL}$  pin after activation of the thermal protection circuit due to the severe short circuit status of the device's output.

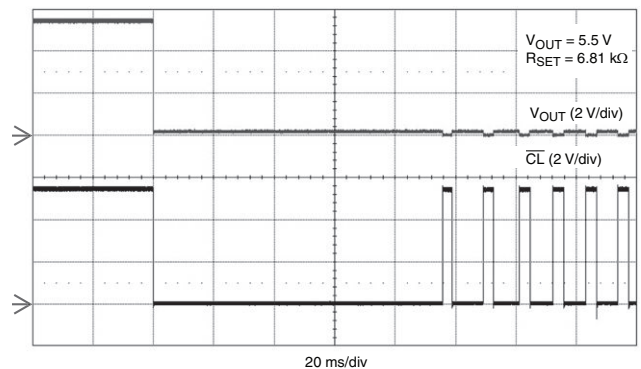


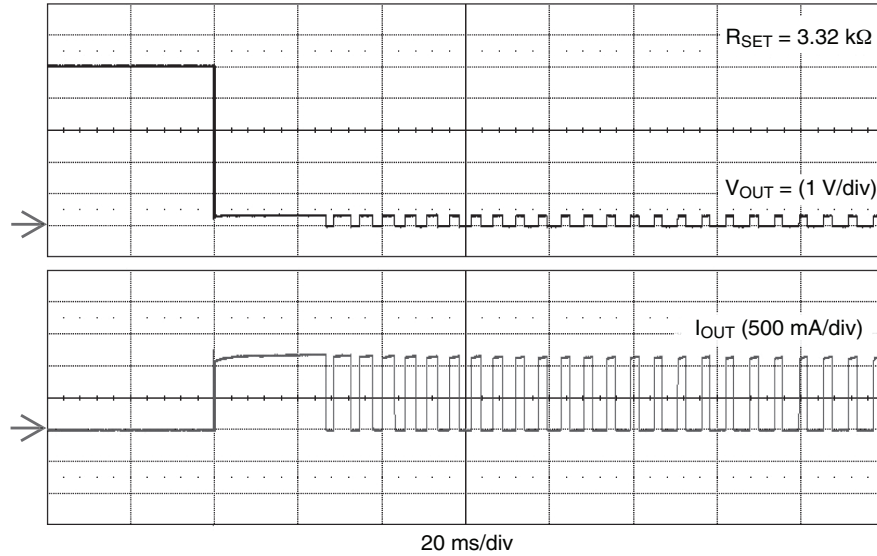
Figure 3

The thermal protection is the final protection to the device. The device will be completely shut down including the open drain current limit indicator pin  $\overline{CL}$  until the device temperature drop below 145 °C.

**Reverse Voltage**

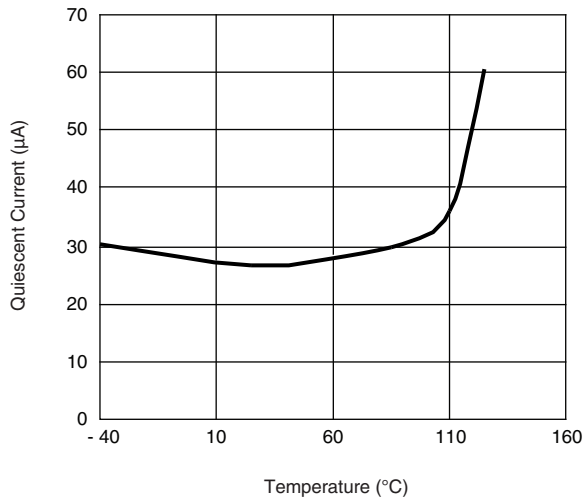
The SiP4613A, SiP4613B is designed to control current flowing from IN to OUT. If the voltage on OUT is raised higher than IN current will flow from OUT to IN but the current limit function will not be available, as can be inferred from the

block diagram in figure 1. Thus, in applications where OUT is used to charge IN, careful considerations must be taken to limit current through the device and protect it from becoming damaged.

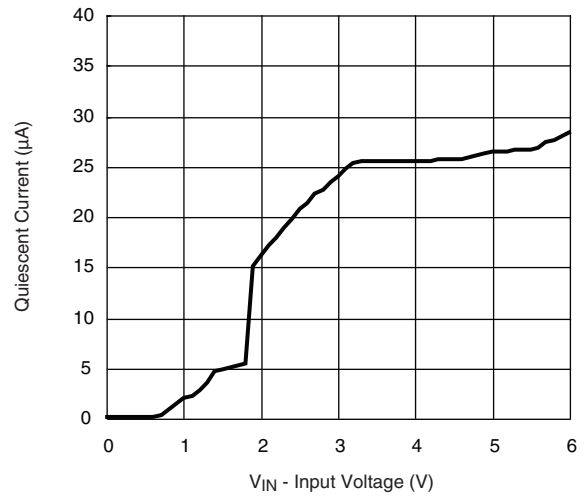


**Figure 4. Current Over load Condition. Load Switch turned on with 0.1 Ω load at time = 0 ms.**

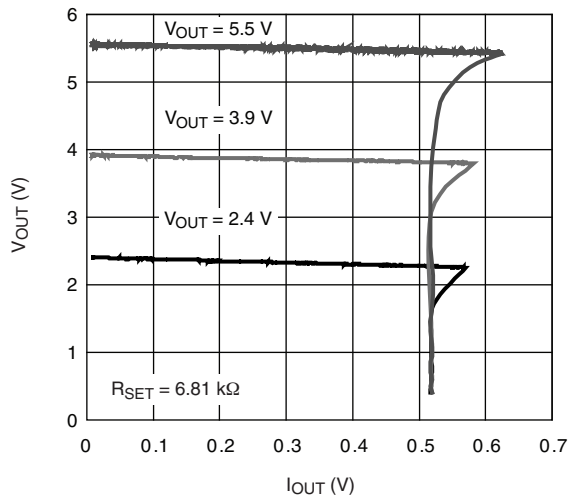
### TYPICAL CHARACTERISTICS 25 °C, unless otherwise noted



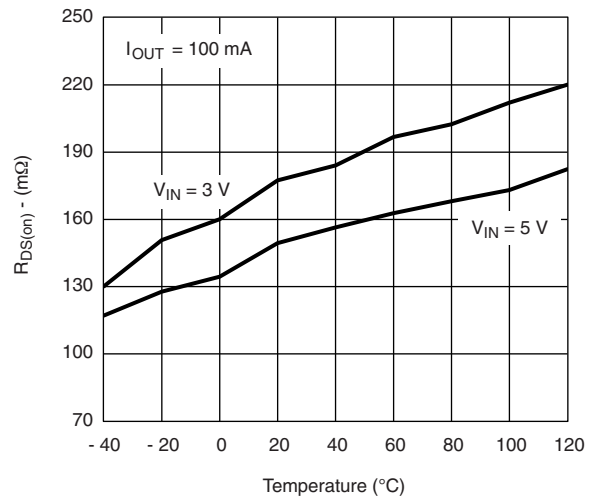
**Quiescent Current vs. Temperature**



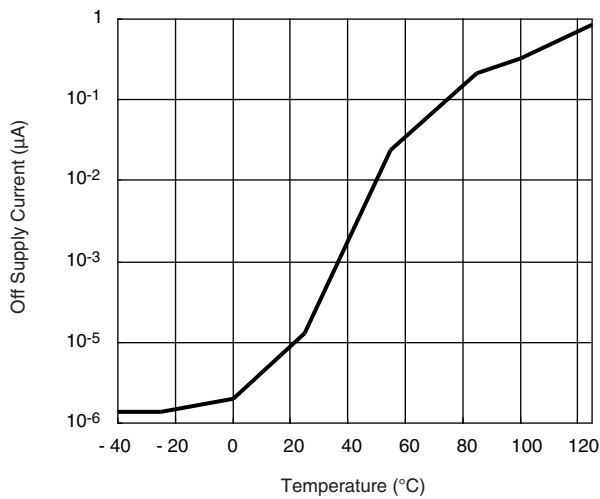
**Quiescent Current vs. Input Voltage**



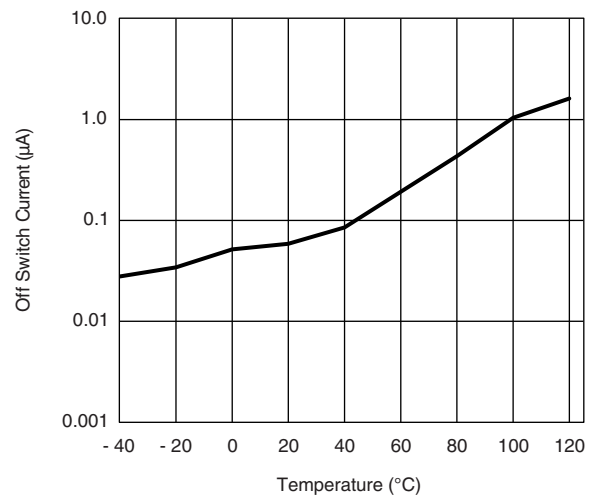
**Output Voltage vs. Output Current**



**R<sub>DS(on)</sub> vs. Temperature**

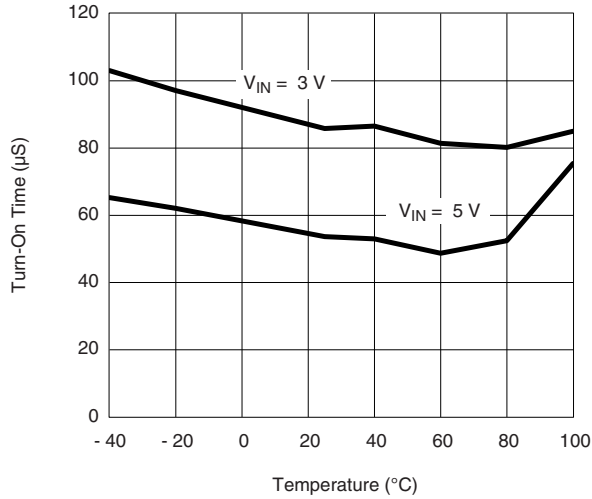


**Off Supply Current vs. Temperature**

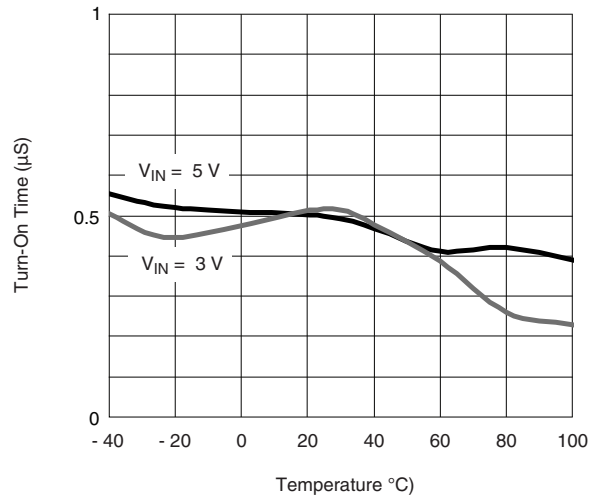


**Off Switch Current vs. Temperature**

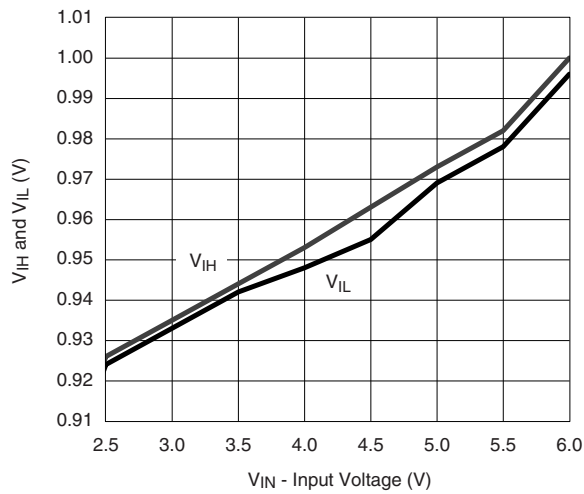
**TYPICAL CHARACTERISTICS** 25 °C, unless otherwise noted



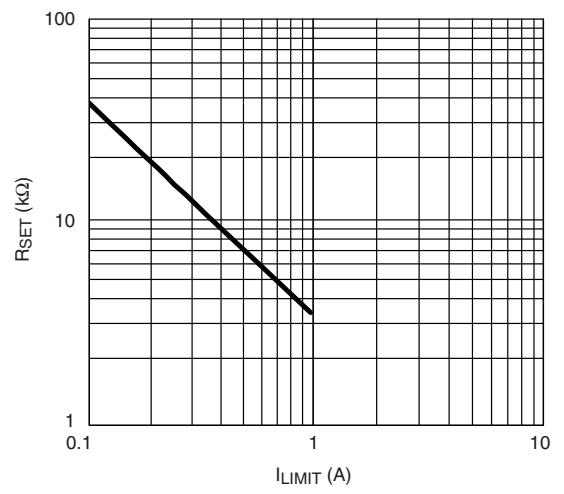
**Turn-On vs. Temperature**  
 $R_L = 10\ \Omega, C_L = 0.47\ \mu\text{F}$



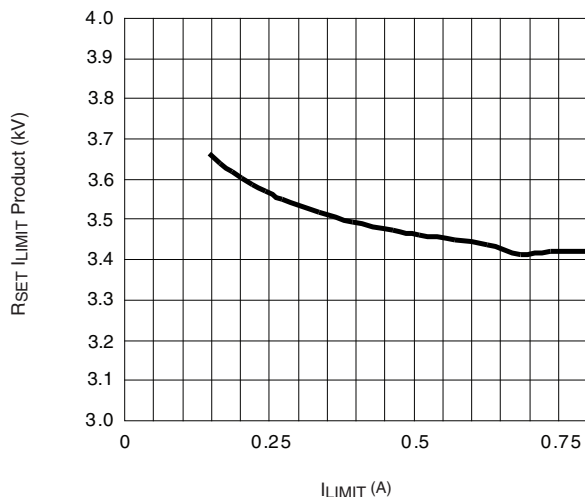
**Turn-Off vs. Temperature**  
 $R_L = 10\ \Omega, C_L = 0.47\ \mu\text{F}$



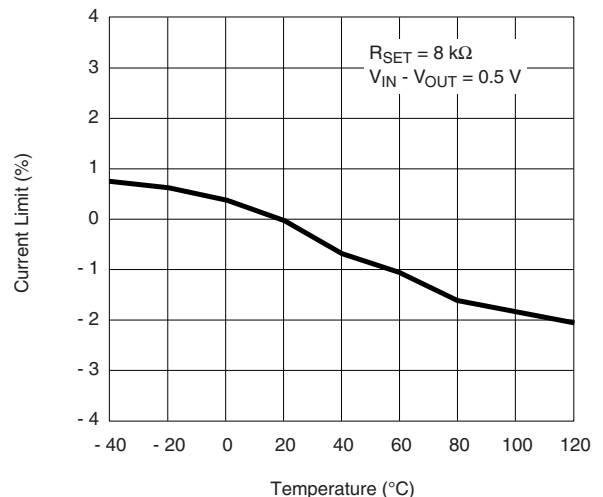
**$V_{IH}$  and  $V_{IL}$  vs.  $V_{IN}$**



**$R_{SET}$  vs.  $I_{LIMIT}$**

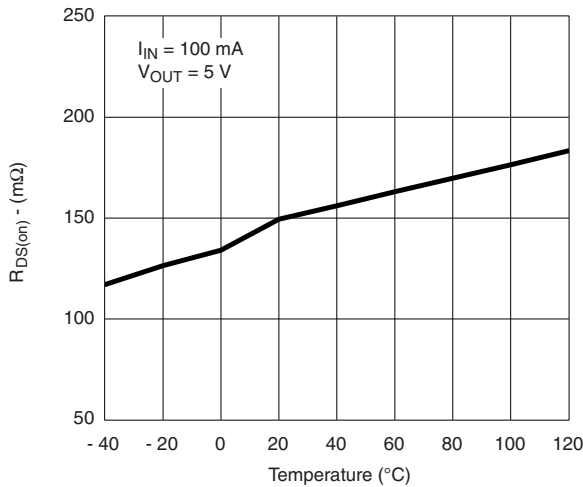


**$R_{SET}$  Coefficient vs.  $I_{LIMIT}$**

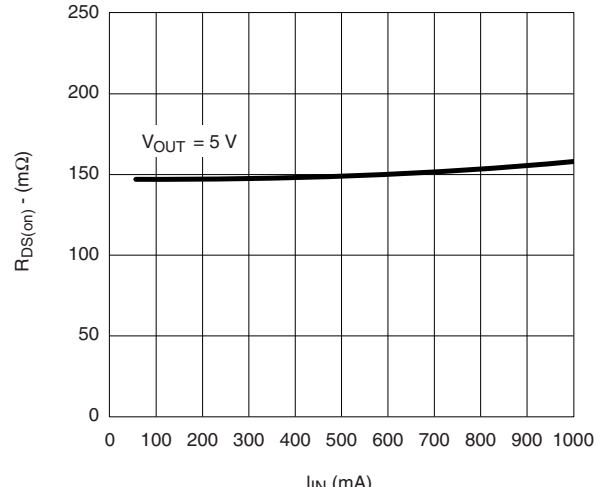


**Current Limit vs. Temperature**  
 $R_{SET} = 8\ \text{k}\Omega$   
 $V_{IN} - V_{OUT} = 0.5\ \text{V}$

### TYPICAL CHARACTERISTICS 25 °C, unless otherwise noted

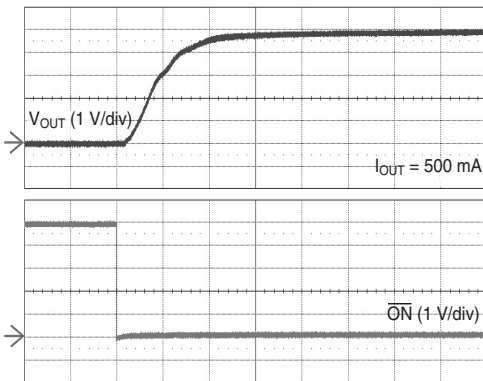


**R<sub>DS(on)\_reverse</sub> vs. Temperature**

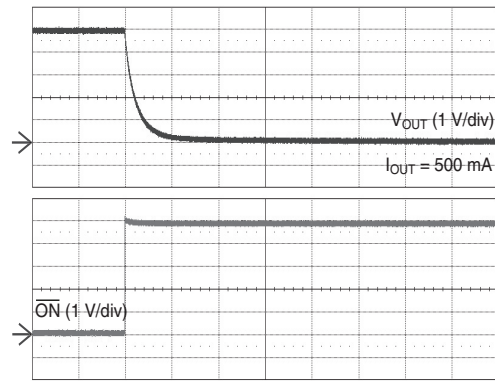


**R<sub>DS(on)\_VOUT-IN</sub> vs. Current**

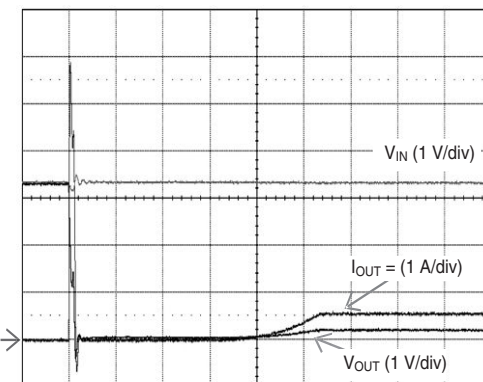
### TYPICAL WAVEFORMS



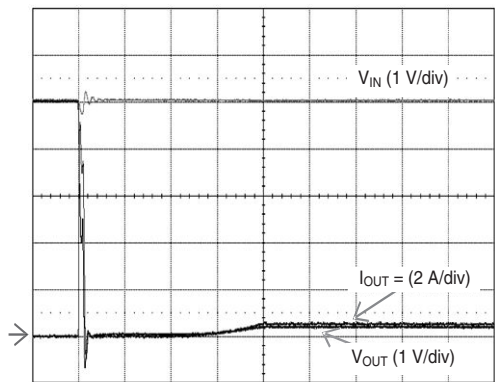
20 μs/div  
**Turn On**



20 μs/div  
**Turn Off**



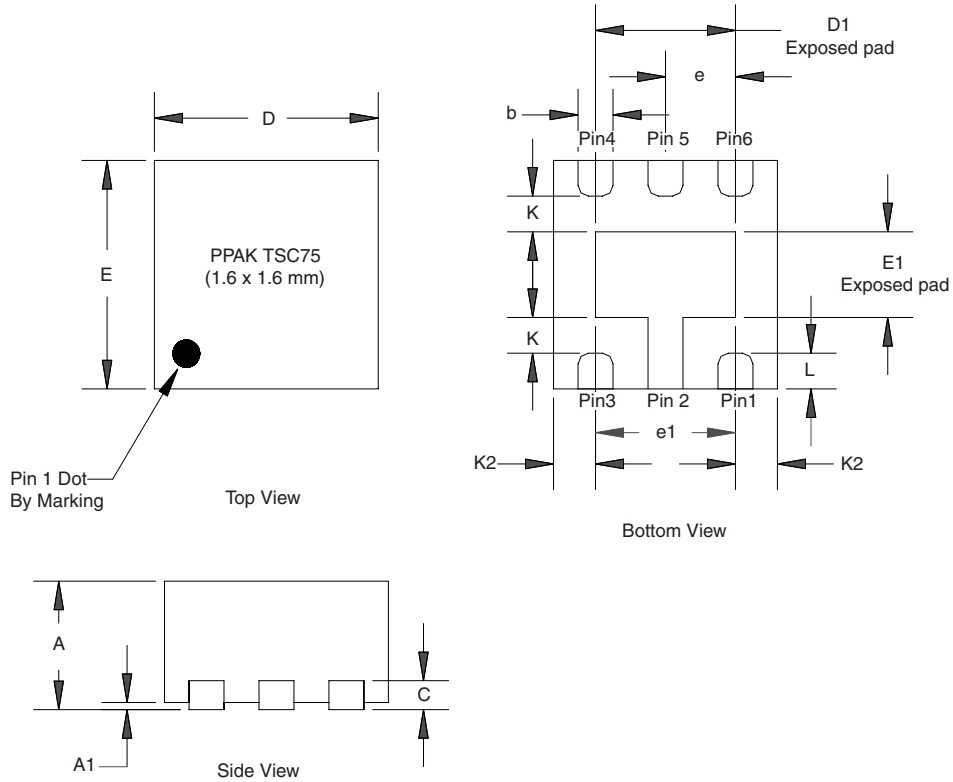
10 μs/div  
**Short Circuit through 0.3 Ω, V<sub>in</sub> = 3.3 V**



10 μs/div  
**Short Circuit through 0.3 Ω, V<sub>in</sub> = 5 V**

Vishay Siliconix maintains worldwide manufacturing capability. Products may be manufactured at one of several qualified locations. Reliability data for Silicon Technology and Package Reliability represent a composite of all qualified locations. For related documents such as package/tape drawings, part marking, and reliability data, see <http://www.vishay.com/ppg?69998>.

## PowerPAK® TSC75-6L (Power IC only)



| DIM                            | MILLIMETERS |      |      | INCHES    |       |       |
|--------------------------------|-------------|------|------|-----------|-------|-------|
|                                | Min         | Nom  | Max  | Min       | Nom   | Max   |
| A                              | 0.50        | 0.55 | 0.65 | 0.020     | 0.022 | 0.026 |
| A1                             | 0           | -    | 0.05 | 0         | -     | 0.002 |
| b                              | 0.20        | 0.25 | 0.30 | 0.008     | 0.010 | 0.012 |
| C                              | 0.10        | 0.15 | 0.20 | 0.006     | 0.008 | 0.010 |
| D                              | 1.55        | 1.60 | 1.65 | 0.0061    | 0.063 | 0.065 |
| D1                             | 0.95        | 1.00 | 1.05 | 0.037     | 0.039 | 0.041 |
| E                              | 1.55        | 1.60 | 1.65 | 0.061     | 0.063 | 0.065 |
| E1                             | 0.55        | 0.60 | 0.65 | 0.022     | 0.024 | 0.026 |
| e                              | 0.50 BSC    |      |      | 0.020 BSC |       |       |
| e1                             | 1.00 BSC    |      |      | 0.039 BSC |       |       |
| K                              | 0.15        | -    | -    | 0.006     | -     | -     |
| K2                             | 0.20        | -    | -    | 0.008     |       |       |
| L                              | 0.20        | 0.25 | 0.30 | 0.008     | 0.010 | 0.012 |
| ECN: S-61919-Rev. A, 02-Oct-06 |             |      |      |           |       |       |
| DWG: 5955                      |             |      |      |           |       |       |



## Disclaimer

ALL PRODUCT, PRODUCT SPECIFICATIONS AND DATA ARE SUBJECT TO CHANGE WITHOUT NOTICE TO IMPROVE RELIABILITY, FUNCTION OR DESIGN OR OTHERWISE.

Vishay Intertechnology, Inc., its affiliates, agents, and employees, and all persons acting on its or their behalf (collectively, "Vishay"), disclaim any and all liability for any errors, inaccuracies or incompleteness contained in any datasheet or in any other disclosure relating to any product.

Vishay makes no warranty, representation or guarantee regarding the suitability of the products for any particular purpose or the continuing production of any product. To the maximum extent permitted by applicable law, Vishay disclaims (i) any and all liability arising out of the application or use of any product, (ii) any and all liability, including without limitation special, consequential or incidental damages, and (iii) any and all implied warranties, including warranties of fitness for particular purpose, non-infringement and merchantability.

Statements regarding the suitability of products for certain types of applications are based on Vishay's knowledge of typical requirements that are often placed on Vishay products in generic applications. Such statements are not binding statements about the suitability of products for a particular application. It is the customer's responsibility to validate that a particular product with the properties described in the product specification is suitable for use in a particular application. Parameters provided in datasheets and / or specifications may vary in different applications and performance may vary over time. All operating parameters, including typical parameters, must be validated for each customer application by the customer's technical experts. Product specifications do not expand or otherwise modify Vishay's terms and conditions of purchase, including but not limited to the warranty expressed therein.

Hyperlinks included in this datasheet may direct users to third-party websites. These links are provided as a convenience and for informational purposes only. Inclusion of these hyperlinks does not constitute an endorsement or an approval by Vishay of any of the products, services or opinions of the corporation, organization or individual associated with the third-party website. Vishay disclaims any and all liability and bears no responsibility for the accuracy, legality or content of the third-party website or for that of subsequent links.

Vishay products are not designed for use in life-saving or life-sustaining applications or any application in which the failure of the Vishay product could result in personal injury or death unless specifically qualified in writing by Vishay. Customers using or selling Vishay products not expressly indicated for use in such applications do so at their own risk. Please contact authorized Vishay personnel to obtain written terms and conditions regarding products designed for such applications.

No license, express or implied, by estoppel or otherwise, to any intellectual property rights is granted by this document or by any conduct of Vishay. Product names and markings noted herein may be trademarks of their respective owners.

## Looking for pricing, stock, or lifecycle information?

Click below to explore more details on WIN SOURCE:

 [View SIP4613BDVP-T1-E3 on WIN SOURCE](#)

 [Vishay Information](#)

## Optimize Your Supply Chain with WIN SOURCE Solutions

-  Global Sourcing Solution
-  Obsolete Management
-  Cost Control Management
-  Shortage Management
-  Alternative Solution
-  Excess Inventory Management