



**THE DATASHEET OF
STK14D88-NF35TR**



Features

- 25, 35, 45 ns Read Access and R/W Cycle Time
- Unlimited Read/Write Endurance
- Automatic Nonvolatile STORE on Power Loss
- Nonvolatile STORE Under Hardware or Software Control
- Automatic RECALL to SRAM on Power Up
- Unlimited RECALL Cycles
- 200K STORE Cycles
- 20-Year Nonvolatile Data Retention
- Single 3.0V +20%, -10% Power Supply
- Commercial, Industrial Temperatures
- Small Footprint SOIC and SSOP Packages (RoHS-Compliant)

Description

The Cypress STK14D88 is a 256Kb fast static RAM with a nonvolatile Quantum Trap storage element included with each memory cell.

The SRAM provides fast access and cycle times, ease of use, and unlimited read and write endurance of a normal SRAM.

Data transfers automatically to the nonvolatile storage cells when power loss is detected (the STORE operation). On power up, data is automatically restored to the SRAM (the RECALL operation). Both STORE and RECALL operations are also available under software control.

The Cypress nvSRAM is the first monolithic nonvolatile memory to offer unlimited writes and reads. It is the highest performance, most reliable nonvolatile memory available.

Logic Block Diagram

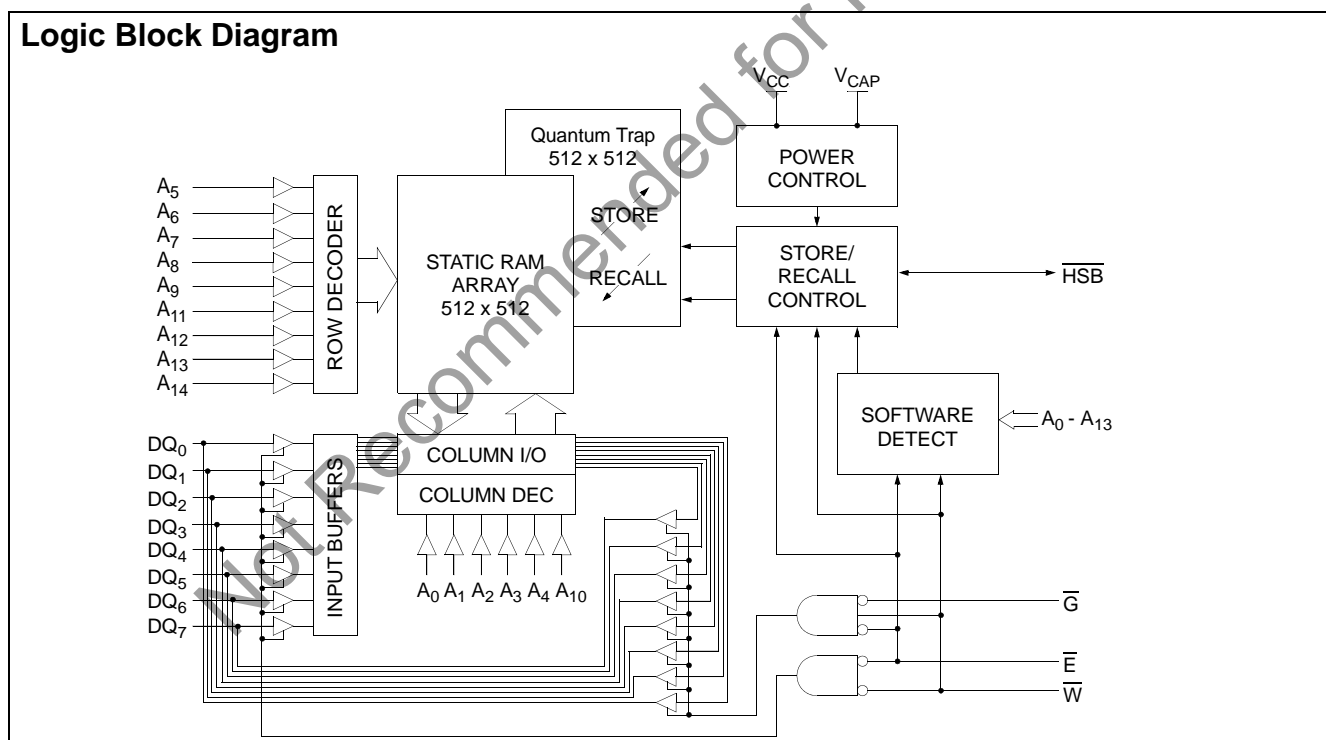

Contents

Features	1	nvSRAM Operation	12
Description	1	nvSRAM	12
Logic Block Diagram	1	SRAM READ	12
Contents	2	SRAM WRITE	12
Pin Configurations	3	AutoStore Operation.....	12
Pin Descriptions	3	Hardware STORE (HSB) Operation.....	12
Absolute Maximum Ratings	4	Software STORE.....	12
DC Characteristics	4	Software RECALL	13
AC Test Conditions	5	Data Protection.....	13
Capacitance	5	Best Practices	13
SRAM READ Cycles #1 and #2	6	Low Average Active Power	13
SRAM WRITE Cycle #1 and #2	7	Noise Considerations	14
AutoStore/POWER UP RECALL	8	Preventing AutoStore	14
Software-Controlled STORE/RECALL Cycle	9	Part Numbering Nomenclature	16
Hardware STORE Cycle	10	Package Diagrams	17
Soft Sequence Commands	10	Document History Page	19
Mode Selection	11	Sales, Solutions, and Legal Information	19
		Worldwide Sales and Design Support.....	19
		Products	19

Not Recommended for New Designs

Pin Configurations

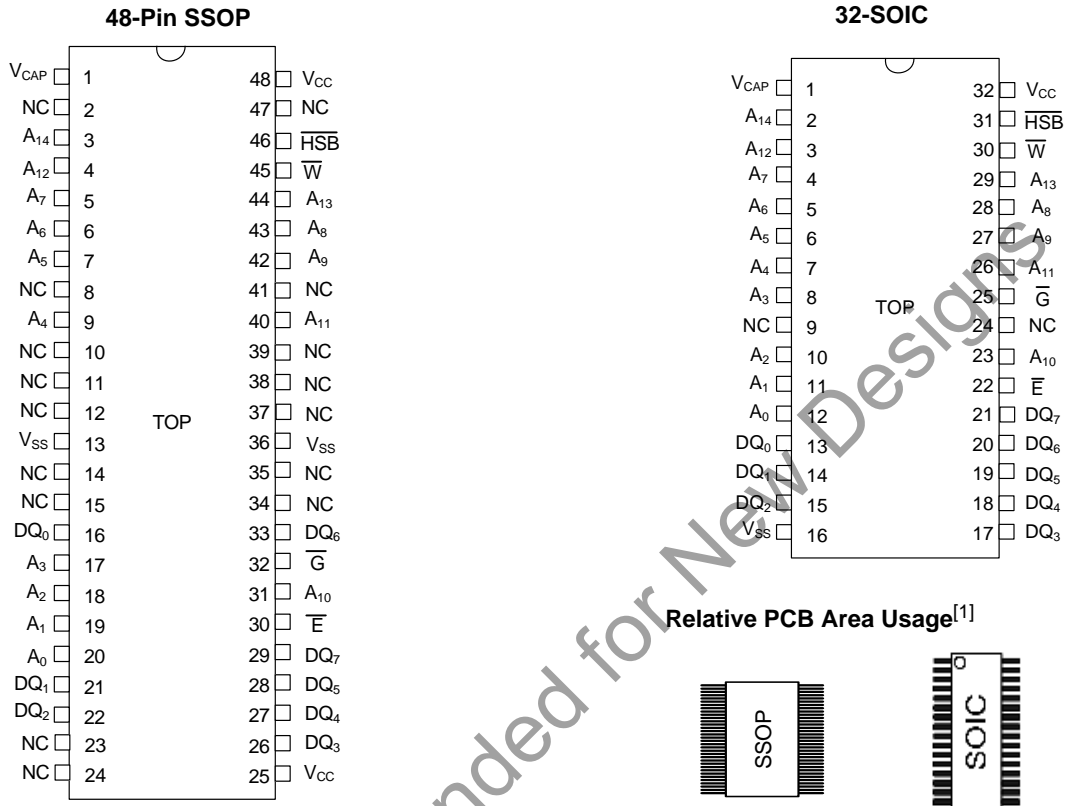
Figure 1. Pin Diagram 48-Pin SSOP/32-SOIC

Pin Descriptions

Pin Name	I/O	Description
A ₁₄ -A ₀	Input	Address: The 15 address inputs select one of 32,768 bytes in the nvSRAM array
DQ ₇ -DQ ₀	I/O	Data: Bi-directional 8-bit data bus for accessing the nvSRAM
E	Input	Chip Enable: The active low E input selects the device
W	Input	Write Enable: The active low W enables data on the DQ pins to be written to the address location latched by the falling edge of E
G	Input	Output Enable: The active low G input enables the data output buffers during read cycles. De-asserting G high caused the DQ pins to tri-state.
V _{CC}	Power Supply	Power: 3.0V, +20%, -10%
HSB	I/O	Hardware Store Busy: When low this output indicates a Store is in progress. When pulled low external to the chip, it initiates a nonvolatile STORE operation. A weak pull up resistor keeps this pin high if not connected. (Connection Optional).
V _{CAP}	Power Supply	AutoStore Capacitor: Supplies power to nvSRAM during power loss to store data from SRAM to nonvolatile storage elements.
V _{SS}	Power Supply	Ground
NC	No Connect	Unlabeled pins have no internal connections.

Note

1. See "Package Diagrams" on page 16 for detailed package size specifications.

Absolute Maximum Ratings

Voltage on Input Relative to Ground.....-0.5V to 4.1V
 Voltage on Input Relative to V_{SS}-0.6V to ($V_{CC} + 0.5V$)
 Voltage on DQ_{0-7} or \overline{HSB} -0.5V to ($V_{CC} + 0.5V$)
 Temperature under Bias -55°C to 125°C
 Storage Temperature -65°C to 140°C
 Power Dissipation 1W
 DC Output Current (1 output at a time, 1s duration).... 15 mA

Note: Stresses greater than those listed under “Absolute Maximum Ratings” may cause permanent damage to the device. This is a stress rating only, and functional operation of the device at conditions above those indicated in the operational sections of this specification is not implied. Exposure to absolute maximum rating conditions for extended periods may affect reliability.

NF (SOP-32) PACKAGE THERMAL CHARACTERISTICS

θ_{jc} 5.4 C/W; θ_{ja} 44.3 [0 fpm], 37.9 [200 fpm], 35.1 C/W [500 fpm].

RF (SSOP-48) PACKAGE THERMAL CHARACTERISTICS

θ_{jc} 6.2 C/W; θ_{ja} 51.1 [0 fpm], 44.7 [200 fpm], 41.8 C/W [500 fpm].

DC Characteristics

($V_{CC} = 2.7V-3.6V$)

Symbol	Parameter ^[2]	Commercial		Industrial		Unit	Notes
		Min	Max	Min	Max		
I_{CC1}	Average V_{CC} Current		65		70	mA	$t_{AVAV} = 25$ ns $t_{AVAV} = 35$ ns $t_{AVAV} = 45$ ns Dependent on output loading and cycle rate. Values obtained without output loads.
			55		60	mA	
			50		55	mA	
I_{CC2}	Average V_{CC} Current during STORE		3		3	mA	All Inputs Don't Care, $V_{CC} = \max$ Average current for duration of STORE cycle (t_{STORE})
I_{CC3}	Average V_{CC} Current at $t_{AVAV} = 200$ ns 3V, 25°C, Typical		10		10	mA	$\overline{W} \geq (V_{CC} - 0.2V)$ All Others Cycling, CMOS Levels Dependent on output loading and cycle rate. Values obtained without output loads.
I_{CC4}	Average V_{CAP} Current during AutoStore Cycle		3		3	mA	All Inputs Don't Care Average current for duration of STORE cycle (t_{STORE})
I_{SB}	V_{CC} Standby Current (Standby, Stable CMOS Input Levels)		3		3	mA	$\overline{E} \geq (V_{CC} - 0.2V)$ All Others $V_{IN} \leq 0.2V$ or $\geq (V_{CC} - 0.2V)$ Standby current level after nonvolatile cycle complete
I_{ILK}	Input Leakage Current		± 1		± 1	μA	$V_{CC} = \max$ $V_{IN} = V_{SS}$ to V_{CC}
I_{OLK}	Off State Output Leakage Current		± 1		± 1	μA	$V_{CC} = \max$ $V_{IN} = V_{SS}$ to V_{CC} , \overline{E} or $\overline{G} \geq V_{IH}$
V_{IH}	Input Logic “1” Voltage	2.0	$V_{CC} + .5$	2.0	$V_{CC} + .5$	V	All Inputs
V_{IL}	Input Logic “0” Voltage	$V_{SS} - .5$	0.8	$V_{SS} - .5$	0.8	V	All Inputs
V_{OH}	Output Logic “1” Voltage	2.4		2.4		V	$I_{OUT} = -2$ mA
V_{OL}	Output Logic “0” Voltage		0.4		0.4	V	$I_{OUT} = 4$ mA

Note:

2. The HSB pin has $I_{OUT} = -10\mu A$ for V_{OH} of 2.4V, this parameter is characterized but not tested

DC Characteristics (continued)

 $(V_{CC} = 2.7V-3.6V)$

Symbol	Parameter ^[2]	Commercial		Industrial		Unit	Notes
		Min	Max	Min	Max		
T_A	Operating Temperature	0	70	-40	85	°C	
V_{CC}	Operating Voltage	2.7	3.6	2.7	3.6	V	3.3V +20%, -10%
V_{CAP}	Storage Capacitance	17	120	17	120	μF	Between V_{CAP} pin and V_{SS} , 5V Rated
$DATA_R$	Data Retention	20		20		K	
NV_C	Nonvolatile STORE Operations	200		200		Years	At 55°C

AC Test Conditions

Input Pulse Levels0V to 3V
 Input Rise and Fall Times ≤5 ns
 Input and Output Timing Reference Levels 1.5V
 Output Load..... See [Figure 2](#) and [Figure 3](#)

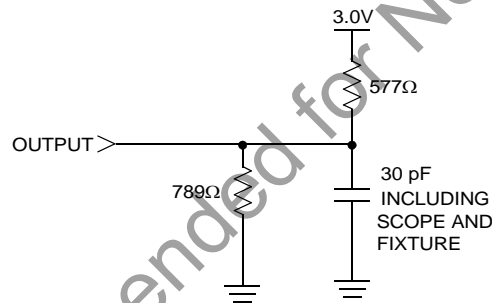
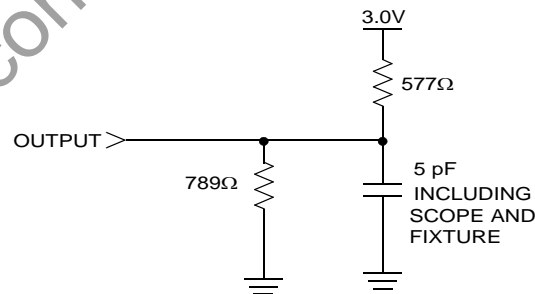
Figure 2. AC Output Loading

Figure 3. AC Output Loading for Tri-state Specs (t_{HZ} , t_{LZ} , t_{WLQZ} , t_{WHQZ} , t_{GLQX} , t_{GHQZ})

Capacitance

Parameter ^[3]	Description	Test Conditions	Max	Unit	Conditions
C_{IN}	Input Capacitance	$T_A = 25^\circ C, f = 1 \text{ MHz}$	7	pF	$\Delta V = 0 \text{ to } 3V$
C_{OUT}	Output Capacitance		7	pF	$\Delta V = 0 \text{ to } 3V$

Note

3. These parameters are guaranteed but not tested.

SRAM READ Cycles #1 and #2

NO.	Symbols			Parameter	STK14D88-25		STK14D88-35		STK14D88-45		Unit
	#1	#2	Alt.		Min	Max	Min	Max	Min	Max	
1		t_{ELQV}	t_{ACS}	Chip Enable Access Time		25		35		45	ns
2	$t_{AVAV}^{[4]}$	$t_{ELEH}^{[4]}$	t_{RC}	Read Cycle Time	25		35		45		ns
3	$t_{AVQV}^{[5]}$	$t_{AVQV}^{[5]}$	t_{AA}	Address Access Time		25		35		45	ns
4		t_{GLQV}	t_{OE}	Output Enable to Data Valid		12		15		20	ns
5	$t_{AXQX}^{[5]}$	$t_{AXQX}^{[5]}$	t_{OH}	Output Hold after Address Change	3		3		3		ns
6		t_{ELQX}	t_{LZ}	Address Change or Chip Enable to Output Active	3		3		3		ns
7		$t_{EHQZ}^{[6]}$	t_{HZ}	Address Change or Chip Disable to Output Inactive		10		13		15	ns
8		t_{GLQX}	t_{OLZ}	Output Enable to Output Active	0		0		0		ns
9		$t_{GHQZ}^{[6]}$	t_{OHZ}	Output Disable to Output Inactive		10		13		15	ns
10		$t_{ELICCH}^{[3]}$	t_{PA}	Chip Enable to Power Active	0		0		0		ns
11		$t_{EHICCL}^{[3]}$	t_{PS}	Chip Disable to Power Standby		25		35		45	ns

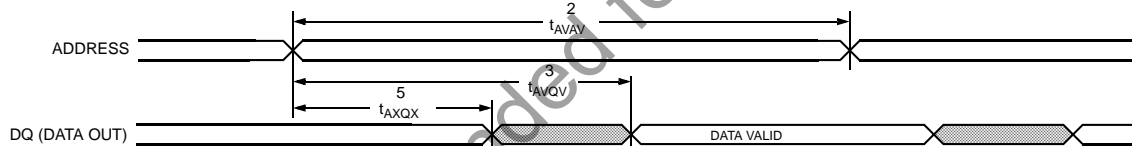
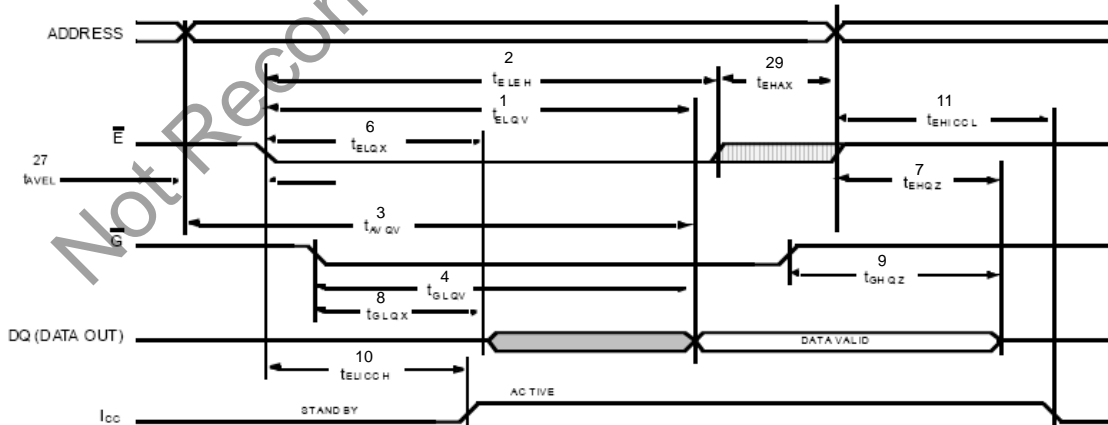
Figure 4. SRAM READ Cycle 1: Address Controlled [4, 5, 6]

Figure 5. SRAM READ Cycle 2: \bar{E} Controlled [4, 7]

Notes

4. \bar{W} must be high during SRAM READ cycles.
5. Device is continuously selected with \bar{E} and \bar{G} both low.
6. Measured ± 200 mV from steady state output voltage.
7. HSB must remain high during READ and WRITE cycles.

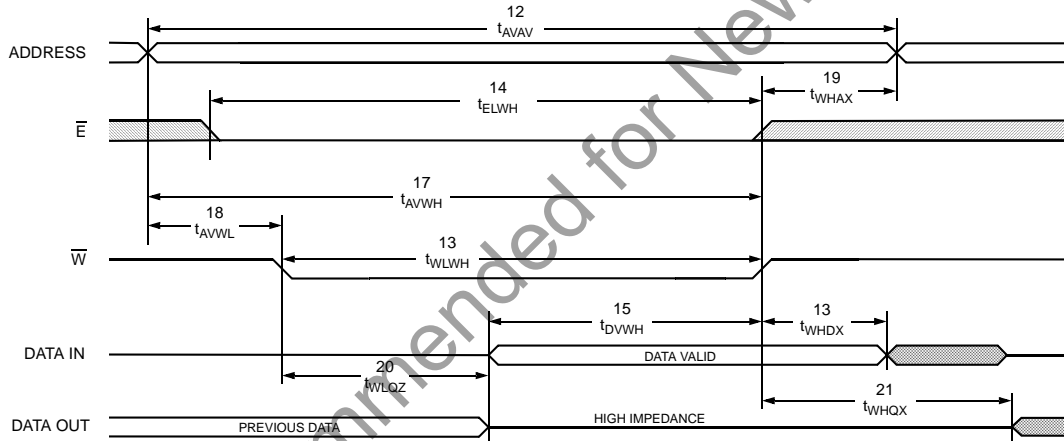
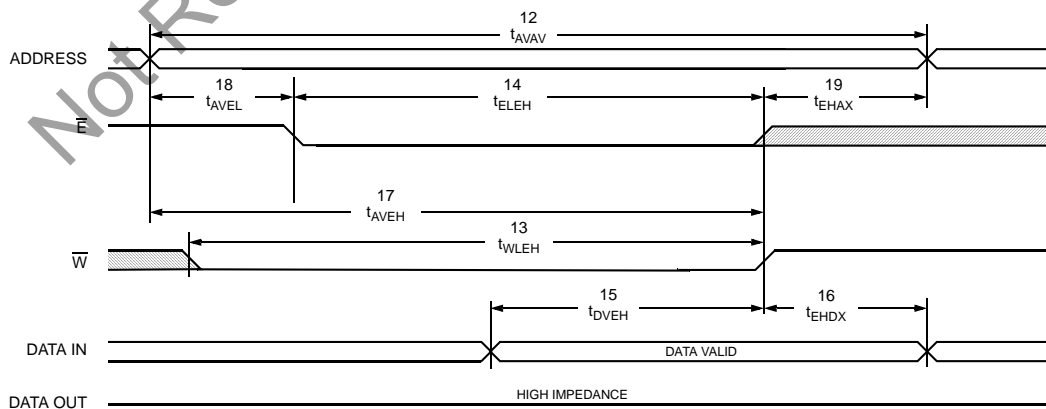
SRAM WRITE Cycle #1 and #2

NO.	Symbols			Parameter	STK14D88-25		STK14D88-35		STK14D88-45		Unit
	#1	#2	Alt.		Min	Max	Min	Max	Min	Max	
12	t_{AVAV}	t_{AVAV}	t_{WC}	Write Cycle Time	25		35		45		ns
13	t_{WLWH}	t_{WLEH}	t_{WP}	Write Pulse Width	20		25		30		ns
14	t_{ELWH}	t_{ELEH}	t_{CW}	Chip Enable to End of Write	20		25		30		ns
15	t_{DVVH}	t_{DVEH}	t_{DW}	Data Set-up to End of Write	10		12		15		ns
16	t_{WHDX}	t_{EHDX}	t_{DH}	Data Hold after End of Write	0		0		0		ns
17	t_{AVWH}	t_{AVEH}	t_{AW}	Address Set-up to End of Write	20		25		30		ns
18	t_{AVWL}	t_{AVEL}	t_{AS}	Address Set-up to Start of Write	0		0		0		ns
19	t_{WHAX}	t_{EHAX}	t_{WR}	Address Hold after End of Write	0		0		0		ns
20	$t_{WLQZ}^{[6, 8]}$		t_{WZ}	Write Enable to Output Disable		10		13		15	ns
21	t_{WHQX}		t_{OW}	Output Active after End of Write	3		3		3		ns

Figure 6. SRAM WRITE Cycle 1: \bar{W} Controlled [8, 9]

Figure 7. SRAM WRITE Cycle 2: \bar{E} Controlled [8, 9]

Notes

8. If \bar{W} is low when \bar{E} goes low, the outputs remain in the high-impedance state.
9. \bar{E} or \bar{W} must be $\geq V_{IH}$ during address transitions.

AutoStore/POWER UP RECALL

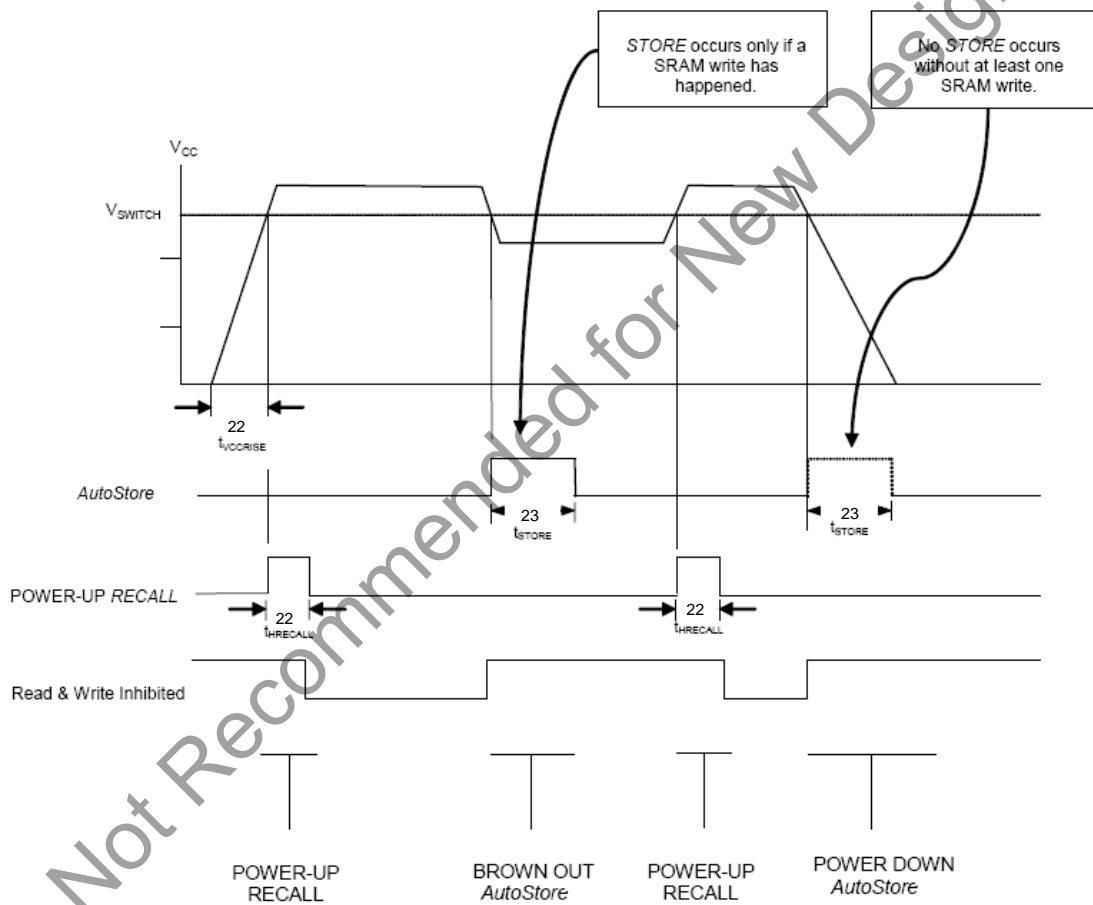
No.	Symbols	Alt.	Parameter	STK14D88		Unit	Notes
				Min	Max		
22	t_{RECALL}		Power up <i>RECALL</i> Duration		20	ms	10
23	t_{STORE}	t_{HLHZ}	<i>STORE</i> Cycle Duration		12.5	ms	11, 12
24	V_{SWITCH}		Low Voltage Trigger Level		2.65	V	
25	V_{CCRISE}		Vcc Rise Time	150		μ s	

Figure 8. AutoStore /POWER UP RECALL



Note: Read and Write cycles are ignored during STORE, RECALL, and while V_{CC} is below V_{SWITCH}

Notes

- 10. t_{RECALL} starts from the time V_{CC} rises above V_{SWITCH}.
- 11. If an SRAM WRITE has not taken place since the last nonvolatile cycle, no STORE will take place.
- 12. Industrial Grade Devices require 15 ms Max.

Software-Controlled STORE/RECALL Cycle^[13, 14]

No.	Symbols		Parameter	STK14D88-25		STK14D88-35		STK14D88-45		Unit	Notes
	\bar{E} Cont	Alternate		Min	Max	Min	Max	Min	Max		
26	t_{AVAV}	t_{RC}	STORE/RECALL Initiation Cycle Time	25		35		45		ns	14
27	t_{AVEL}	t_{AS}	Address Setup Time	0		0		0		ns	
28	t_{ELEH}	t_{CW}	Clock Pulse Width	20		25		30		ns	
29	t_{EHAX}		Address Hold Time	1		1		1		ns	
30	t_{RECALL}		RECALL Duration		50		50		50	μ s	

Figure 9. \bar{E} and \bar{G} Controlled Software STORE/RECALL Cycle^[14]

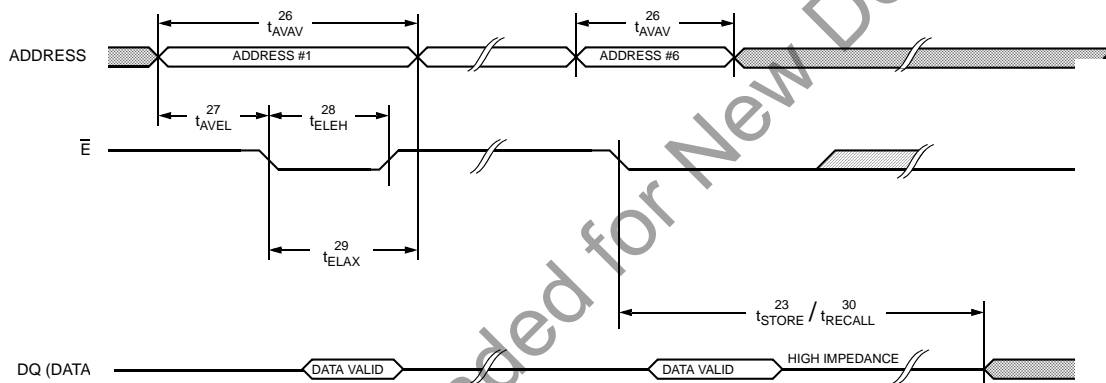

Notes

- 13. The software sequence is clocked on the falling edge of \bar{E} controlled READS.
- 14. The six consecutive addresses must be read in the order listed in the software STORE/RECALL Mode Selection Table. \bar{W} must be high during all six consecutive cycles

Hardware STORE Cycle

NO.	Symbols		Parameter	STK14D88		Unit	Notes
	Standard	Alternate		Min	Max		
31	t_{DELAY}	t_{HLQZ}	Hardware STORE to SRAM Disabled	1	70	μs	15
32	t_{HLHX}		Hardware STORE Pulse Width	15		ns	

Figure 10. Hardware STORE Cycle

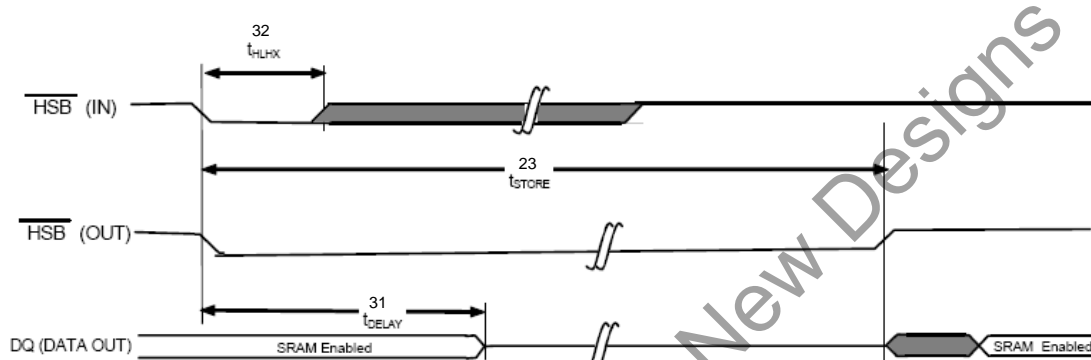

Soft Sequence Commands

NO.	Symbols	Parameter	STK14D88		Unit	Notes
	Standard		Min	Max		
33	t_{SS}	Soft Sequence Processing Time		70	μs	16, 17

Figure 11. Software Sequence Commands

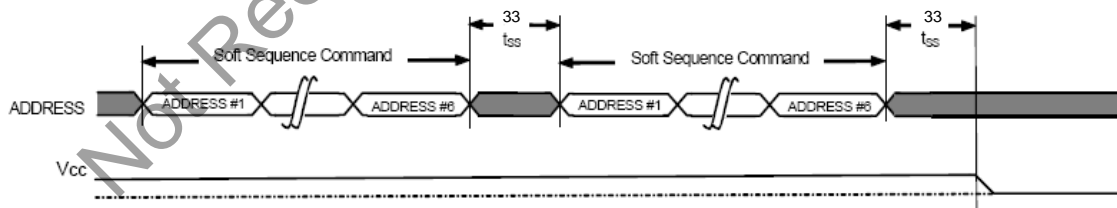

Notes

- 15. Read and Write cycles in progress before \overline{HSB} is asserted are given this minimum amount of time to complete.
- 16. This is the amount of time that it takes to take action on a soft sequence command. Vcc power must remain high to effectively register command.
- 17. Commands like Store and Recall lock out I/O until operation is complete which further increases this time. See specific command.

Mode Selection

\bar{E}	\bar{W}	\bar{G}	A ₁₄ -A ₀	Mode	IO	Power	Notes
H	X	X	X	Not Selected	Output High Z	Standby	
L	H	L	X	Read SRAM	Output Data	Active	
L	L	X	X	Write SRAM	Input Data	Active	
L	H	L	0x0E38 0x31C7 0x03E0 0x3C1F 0x303F 0x03F8	Read SRAM Read SRAM Read SRAM Read SRAM Read SRAM AutoStore Disable	Output Data Output Data Output Data Output Data Output Data Output Data	Active	18, 19, 20
L	H	L	0x0E38 0x31C7 0x03E0 0x3C1F 0x303F 0x07F0	Read SRAM Read SRAM Read SRAM Read SRAM Read SRAM AutoStore Enable	Output Data Output Data Output Data Output Data Output Data Output Data	Active	18, 19, 20
L	H	L	0x0E38 0x31C7 0x03E0 0x3C1F 0x303F 0x0FC0	Read SRAM Read SRAM Read SRAM Read SRAM Read SRAM Nonvolatile Store	Output Data Output Data Output Data Output Data Output Data Output High Z	Active I _{CC2}	18, 19, 20
L	H	L	0x0E38 0x31C7 0x03E0 0x3C1F 0x303F 0x0C63	Read SRAM Read SRAM Read SRAM Read SRAM Read SRAM Nonvolatile Recall	Output Data Output Data Output Data Output Data Output Data Output High Z	Active	18, 19, 20

Notes

18. The six consecutive addresses must be in the order listed. \bar{W} must be high during all six consecutive cycles to enable a nonvolatile cycle.
 19. While there are 15 addresses on the STK14D88, only the lower 14 are used to control software modes
 20. I/O state depends on the state of \bar{G} . The I/O table shown assumes \bar{G} low.

nvSRAM Operation

nvSRAM

The STK14D88 nvSRAM is made up of two functional components paired in the same physical cell. These are the SRAM memory cell and a nonvolatile QuantumTrap cell. The SRAM memory cell operates like a standard fast static RAM. Data in the SRAM can be transferred to the nonvolatile cell (the STORE operation), or from the nonvolatile cell to SRAM (the RECALL operation). This unique architecture allows all cells to be stored and recalled in parallel. During the STORE and RECALL operations SRAM READ and WRITE operations are inhibited. The STK14D88 supports unlimited read and writes like a typical SRAM. In addition, it provides unlimited RECALL operations from the nonvolatile cells and up to 200K STORE operations.

SRAM READ

The STK14D88 performs a READ cycle whenever \bar{E} and \bar{G} are low while \bar{W} and HSB are high. The address specified on pins A_{0-16} determine which of the 32,768 data bytes will be accessed. When the READ is initiated by an address transition, the outputs will be valid after a delay of t_{AVQV} (READ cycle #1). If the READ is initiated by \bar{E} and \bar{G} , the outputs will be valid at t_{ELQV} or at t_{GLQV} , whichever is later (READ cycle #2). The data outputs repeatedly respond to address changes within the t_{AVQV} access time without the need for transitions on any control input pins, and remain valid until another address change or until either \bar{E} or \bar{G} is brought high, or \bar{W} or HSB is brought low.

SRAM WRITE

A WRITE cycle is performed whenever \bar{E} and \bar{W} are low and HSB is high. The address inputs must be stable prior to entering the WRITE cycle and must remain stable until either \bar{E} or \bar{W} goes high at the end of the cycle. The data on the common I/O pins DQ_{0-7} will be written into memory if it is valid t_{DVWH} before the end of a \bar{W} controlled WRITE or t_{DVEH} before the end of an \bar{E} controlled WRITE.

It is recommended that \bar{G} be kept high during the entire WRITE cycle to avoid data bus contention on common I/O lines. If \bar{G} is left low, internal circuitry will turn off the output buffers t_{WLQZ} after \bar{w} goes low.

AutoStore Operation

The STK14D88 stores data to nvSRAM using one of three storage operations. These three operations are Hardware Store (activated by HSB), Software Store (activated by an address sequence), and AutoStore (on power down).

AutoStore operation is a unique feature of Cypress Quantum Trap technology is enabled by default on the STK14D88.

During normal operation, the device will draw current from V_{CC} to charge a capacitor connected to the V_{CAP} pin. This stored charge will be used by the chip to perform a single STORE operation. If the voltage on the V_{CC} pin drops below V_{SWITCH} , the part will automatically disconnect the V_{CAP} pin from V_{CC} . A STORE operation will be initiated with power provided by the V_{CAP} capacitor.

Figure 12 shows the proper connection of the storage capacitor (V_{CAP}) for automatic store operation. Refer to the DC CHARACTERISTICS table for the size of the capacitor. The voltage on the

V_{CAP} pin is driven to 5V by a charge pump internal to the chip. A pull up should be placed on \bar{W} to hold it inactive during power up.

To reduce unneeded nonvolatile stores, AutoStore and Hardware Store operations will be ignored unless at least one WRITE operation has taken place since the most recent STORE or RECALL cycle. Software initiated STORE cycles are performed regardless of whether a WRITE operation has taken place. The HSB signal can be monitored by the system to detect an AutoStore cycle is in progress.

Figure 12. AutoStore Mode

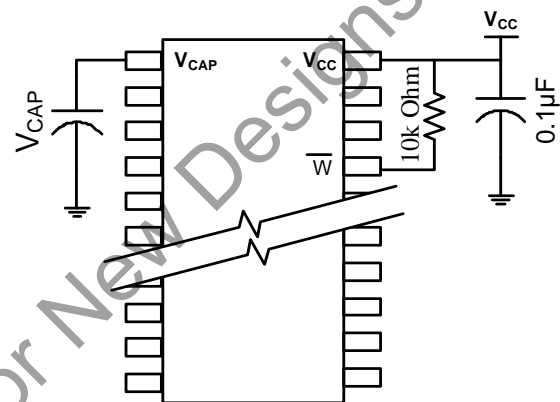

Hardware STORE (\bar{HSB}) Operation

The STK14D88 provides the \bar{HSB} pin for controlling and acknowledging the STORE operations. The \bar{HSB} pin can be used to request a hardware STORE cycle. When the \bar{HSB} pin is driven low, the STK14D88 will conditionally initiate a STORE operation after t_{DELAY} . An actual STORE cycle will only begin if a WRITE to the SRAM took place since the last STORE or RECALL cycle. The \bar{HSB} pin has a very resistive pull up and is internally driven low to indicate a busy condition while the STORE (initiated by any means) is in progress. This pin should be externally pulled up if it is used to drive other inputs.

SRAM READ and WRITE operations that are in progress when \bar{HSB} is driven low by any means are given time to complete before the STORE operation is initiated. After \bar{HSB} goes low, the STK14D88 continues SRAM operations for t_{DELAY} . During t_{DELAY} , multiple SRAM READ operations may take place. If a WRITE is in progress when \bar{HSB} is pulled low, it will be allowed a time, t_{DELAY} , to complete. However, any SRAM WRITE cycles requested after \bar{HSB} goes low will be inhibited until \bar{HSB} returns high.

If \bar{HSB} is not used, it should be left unconnected.

Software STORE

Data can be transferred from the SRAM to the nonvolatile memory by a software address sequence. The STK14D88 software STORE cycle is initiated by executing sequential \bar{E} controlled READ cycles from six specific address locations in exact order. During the STORE cycle, previous data is erased and then the new data is programmed into the nonvolatile elements. Once a STORE cycle is initiated, further memory inputs and outputs are disabled until the cycle is completed.

To initiate the software STORE cycle, the following READ sequence must be performed:

1. Read Address 0x0E38, Valid READ
2. Read Address 0x31C7, Valid READ
3. Read Address 0x03E0, Valid READ
4. Read Address 0x3C1F, Valid READ
5. Read Address 0x303F, Valid READ
6. Read Address 0x0FC0, Initiate STORE Cycle

After the sixth address in the sequence has been entered, the STORE cycle begins and the chip is disabled. It is important that READ cycles and not WRITE cycles be used in the sequence. After the t_{STORE} cycle time has been fulfilled, the SRAM is again activated for READ and WRITE operation.

Software RECALL

Data can be transferred from the nonvolatile memory to the SRAM by a software address sequence. A software RECALL cycle is initiated with a sequence of READ operations in a manner similar to the software STORE initiation. To initiate the RECALL cycle, the following sequence of \bar{E} controlled READ operations must be performed:

1. Read Address 0x0E38, Valid READ
2. Read Address 0x31C7, Valid READ
3. Read Address 0x03E0, Valid READ
4. Read Address 0x3C1F, Valid READ
5. Read Address 0x303F, Valid READ
6. Read Address 0x0C63, Initiate RECALL Cycle

Internally, RECALL is a two-step procedure. First, the SRAM data is cleared, and second, the nonvolatile information is transferred into the SRAM cells. After the t_{RECALL} cycle time, the SRAM will once again be ready for READ or WRITE operations. The RECALL operation in no way alters the data in the nonvolatile storage elements.

Data Protection

The STK14D88 protects data from corruption during low-voltage conditions by inhibiting all externally initiated STORE and WRITE operations. The low-voltage condition is detected when $V_{CC} < V_{SWITCH}$.

If the STK14D88 is in a WRITE mode (both \bar{E} and \bar{W} low) at power up, after a RECALL, or after a STORE, the WRITE will be inhibited until a negative transition on \bar{E} or \bar{W} is detected. This protects against inadvertent writes during power up or brown out conditions.

Best Practices

nvSRAM products have been used effectively for over 15 years. While ease-of-use is one of the product's main system values, experience gained working with hundreds of applications has resulted in the following suggestions as best practices:

- The nonvolatile cells in an nvSRAM are programmed on the test floor during final test and quality assurance. Incoming inspection routines at customer or contract manufacturer's sites sometimes reprogram these values. Final NV patterns are typically repeating patterns of AA, 55, 00, FF, A5, or 5A. End product's firmware should not assume an NV array is in a set programmed state. Routines that check memory content values to determine first time system configuration, cold or warm boot status, and so on, should always program a unique NV pattern (for example, a complex 4-byte pattern of 46 E6 49 53 hex or more random bytes) as part of the final system manufacturing test to ensure these system routines work consistently.
 - Power up boot firmware routines should rewrite the nvSRAM into the desired state (such as AutoStore enabled). While the nvSRAM is shipped in a preset state, best practice is to rewrite the nvSRAM into the desired state as a safeguard against events that might flip the bit inadvertently (such as program bugs, incoming inspection routines, and others).
 - If AutoStore has been firmware disabled, it will not reset to "autostore enabled" on every power down event captured by the nvSRAM. The application firmware should re-enable or re-disable AutoStore on each reset sequence based on the behavior desired.
 - The V_{CAP} value specified in this data sheet includes a minimum and a maximum value size. Best practice is to meet this requirement and not exceed the max V_{CAP} value because the nvSRAM internal algorithm calculates V_{CAP} charge time based on this max V_{CAP} value. Customers who want to use a larger V_{CAP} value to make sure there is extra store charge and store time should discuss their V_{CAP} size selection with Cypress to understand any impact on the V_{CAP} voltage level at the end of a t_{RECALL} period.
- ### Low Average Active Power
- CMOS technology provides the STK14D88 with the benefit of power supply current that scales with cycle time. Less current will be drawn as the memory cycle time becomes longer than 50 ns. [Figure 13](#) shows the relationship between I_{CC} and READ/WRITE cycle time. Worst-case current consumption is shown for commercial temperature range, $V_{CC} = 3.6V$, and chip enable at maximum frequency. Only standby current is drawn when the chip is disabled. The overall average current drawn by the STK14D88 depends on the following items:
- The duty cycle of chip enable
 - The overall cycle rate for operations
 - The ratio of READs to WRITEs
 - The operating temperature
 - The V_{CC} level
 - I/O loading

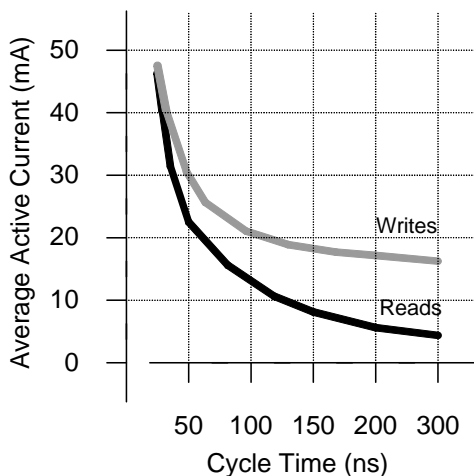
Figure 13. Current versus Cycle Time

Noise Considerations

The STK14D88 is a high speed memory and so must have a high frequency bypass capacitor of 0.1 μ F connected between both V_{CC} pins and V_{SS} ground plane with no plane break to chip V_{SS} . Use leads and traces that are as short as possible. As with all high speed CMOS ICs, careful routing of power, ground, and signals will reduce circuit noise.

Preventing AutoStore

The AutoStore function can be disabled by initiating an *AutoStore Disable* sequence. A sequence of READ operations is performed in a manner similar to the software STORE initiation. To initiate the *AutoStore Disable* sequence, the following sequence of \bar{E} controlled or \bar{G} controlled READ operations must be performed:

1. Read Address 0x0E38, Valid READ
2. Read Address 0x31C7, Valid READ
3. Read Address 0x03E0, Valid READ
4. Read Address 0x3C1F, Valid READ
5. Read Address 0x303F, Valid READ
6. Read Address 0x03F8, AutoStore Disable

The AutoStore can be re-enabled by initiating an *AutoStore Enable* sequence. A sequence of READ operations is performed in a manner similar to the software RECALL initiation. To initiate the *AutoStore Enable* sequence, the following sequence of \bar{E} controlled or \bar{G} controlled READ operations must be performed:

1. Read Address 0x0E38, Valid READ
2. Read Address 0x31C7, Valid READ
3. Read Address 0x03E0, Valid READ
4. Read Address 0x3C1F, Valid READ
5. Read Address 0x303F, Valid READ
6. Read Address 0x07F0, AutoStore Enable

If the AutoStore function is disabled or re-enabled, a manual STORE operation (Hardware or Software) needs to be issued to save the AutoStore state through subsequent power down cycles. The part comes from the factory with AutoStore enabled.

In all cases, make sure the READ sequence is uninterrupted. For example, an interrupt that occurs in the sequence that reads the nvSRAM would abort this sequence, resulting in an error.

Part Numbering Nomenclature

STK14D88 - R F 45 I TR

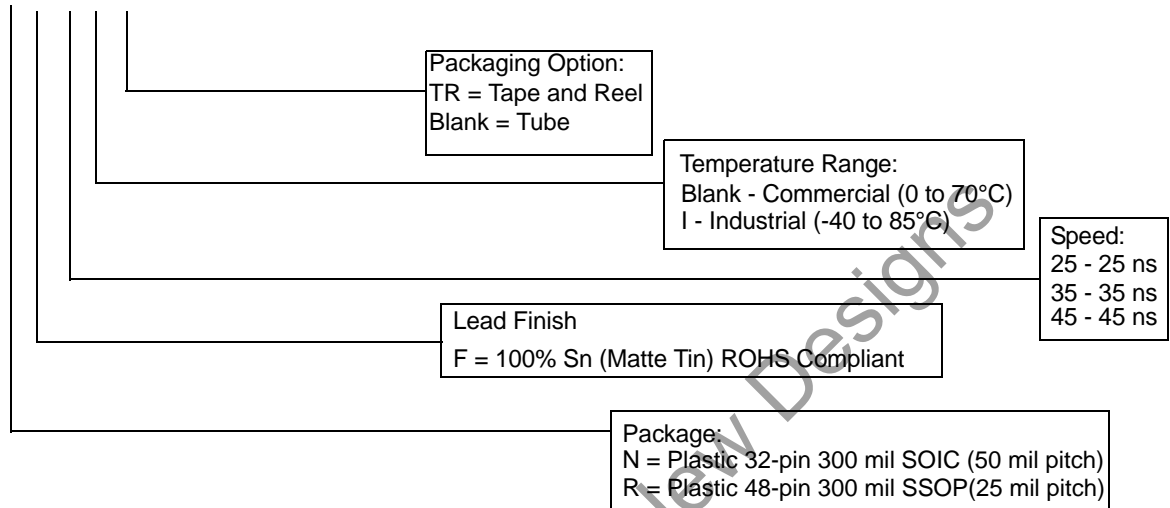

Ordering Codes

These parts are not recommended for new designs.

Part Number	Description	Access Times	Temperature
STK14D88-NF25	3V 32Kx8 AutoStore nvSRAM SOP32-300	25 ns	Commercial
STK14D88-NF35	3V 32Kx8 AutoStore nvSRAM SOP32-300	35 ns	Commercial
STK14D88-NF45	3V 32Kx8 AutoStore nvSRAM SOP32-300	45 ns	Commercial
STK14D88-NF25TR	3V 32Kx8 AutoStore nvSRAM SOP32-300	25 ns	Commercial
STK14D88-NF35TR	3V 32Kx8 AutoStore nvSRAM SOP32-300	35 ns	Commercial
STK14D88-NF45TR	3V 32Kx8 AutoStore nvSRAM SOP32-300	45 ns	Commercial
STK14D88-RF25	3V 32Kx8 AutoStore nvSRAM SSOP48-300	25 ns	Commercial
STK14D88-RF35	3V 32Kx8 AutoStore nvSRAM SSOP48-300	35 ns	Commercial
STK14D88-RF45	3V 32Kx8 AutoStore nvSRAM SSOP48-300	45 ns	Commercial
STK14D88-RF25TR	3V 32Kx8 AutoStore nvSRAM SSOP48-300	25 ns	Commercial
STK14D88-RF35TR	3V 32Kx8 AutoStore nvSRAM SSOP48-300	35 ns	Commercial
STK14D88-RF45TR	3V 32Kx8 AutoStore nvSRAM SSOP48-300	45 ns	Commercial
STK14D88-NF25I	3V 32Kx8 AutoStore nvSRAM SOP32-300	25 ns	Industrial
STK14D88-NF35I	3V 32Kx8 AutoStore nvSRAM SOP32-300	35 ns	Industrial
STK14D88-NF45I	3V 32Kx8 AutoStore nvSRAM SOP32-300	45 ns	Industrial
STK14D88-NF25ITR	3V 32Kx8 AutoStore nvSRAM SOP32-300	25 ns	Industrial
STK14D88-NF35ITR	3V 32Kx8 AutoStore nvSRAM SOP32-300	35 ns	Industrial
STK14D88-NF45ITR	3V 32Kx8 AutoStore nvSRAM SOP32-300	45 ns	Industrial
STK14D88-RF25I	3V 32Kx8 AutoStore nvSRAM SSOP48-300	25 ns	Industrial
STK14D88-RF35I	3V 32Kx8 AutoStore nvSRAM SSOP48-300	35 ns	Industrial
STK14D88-RF45I	3V 32Kx8 AutoStore nvSRAM SSOP48-300	45 ns	Industrial
STK14D88-RF25ITR	3V 32Kx8 AutoStore nvSRAM SSOP48-300	25 ns	Industrial
STK14D88-RF35ITR	3V 32Kx8 AutoStore nvSRAM SSOP48-300	35 ns	Industrial
STK14D88-RF45ITR	3V 32Kx8 AutoStore nvSRAM SSOP48-300	45 ns	Industrial

Package Diagrams

Figure 14. 32-Pin (300 Mil) SOIC (51-85127)

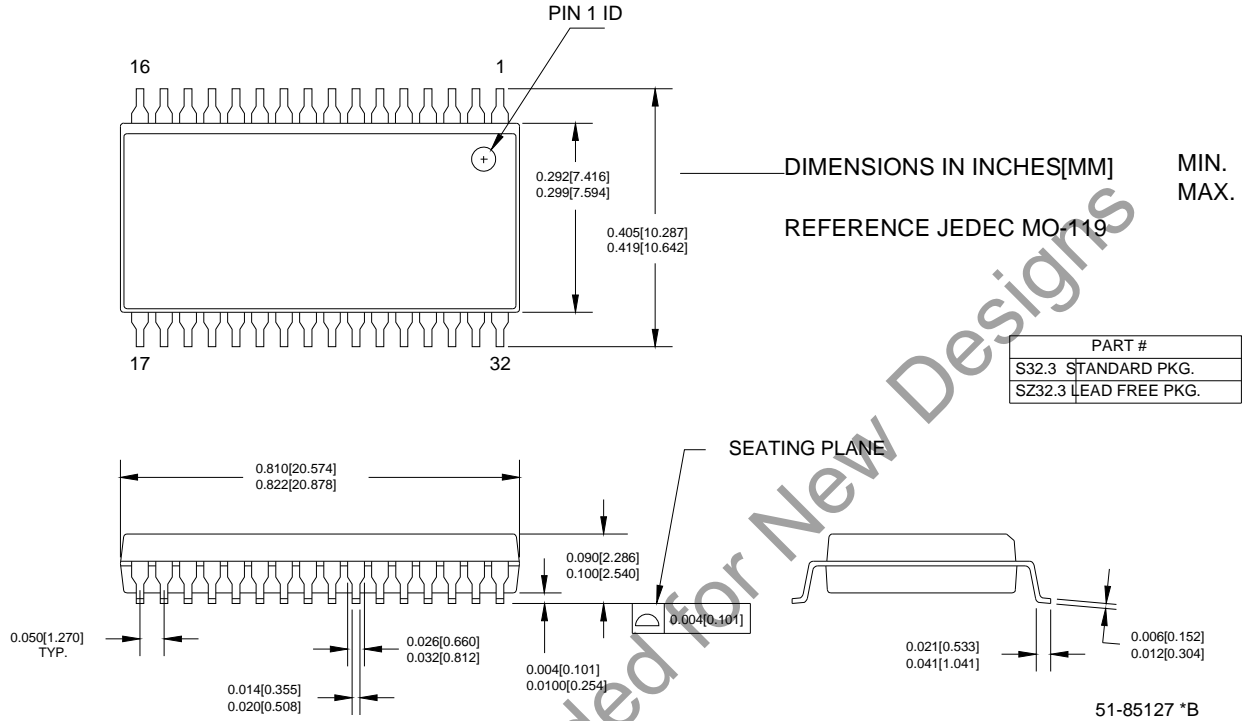

Package Diagrams (continued)

Figure 15. 48-Pin (300 Mil) SSOP (51-85061)

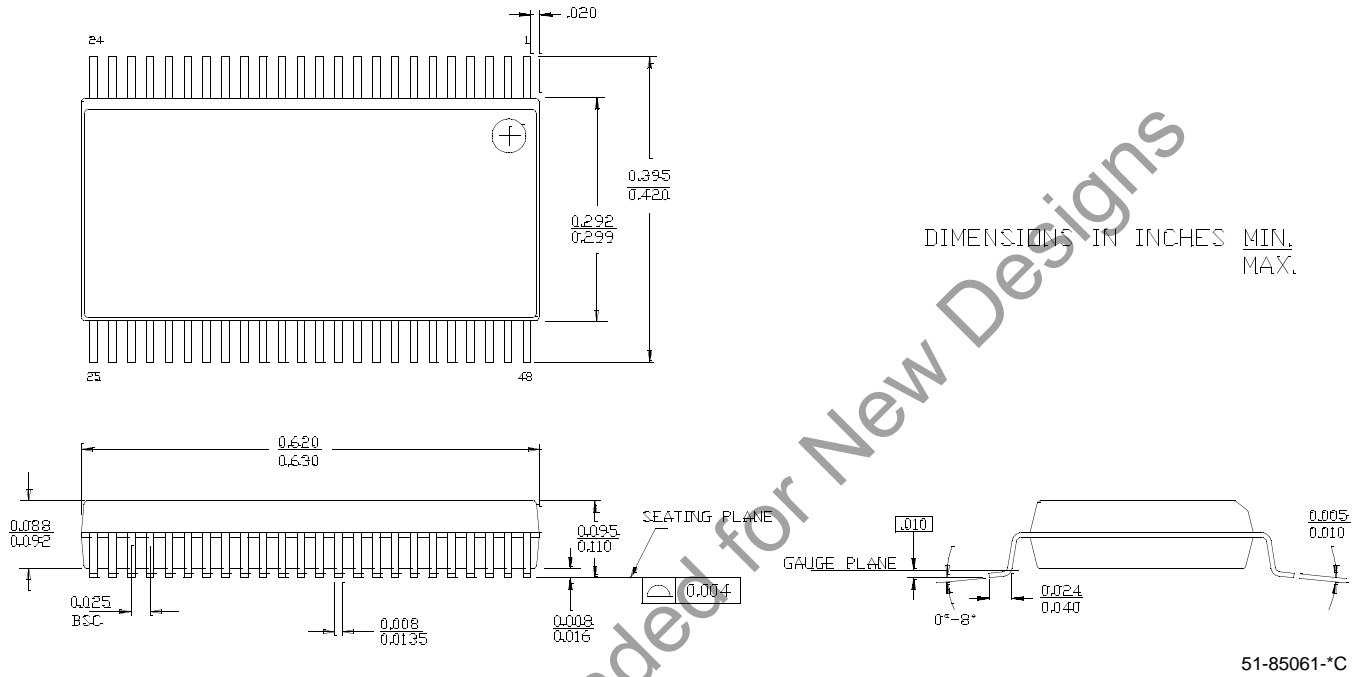

Document History Page

Document Title: STK14D88 32Kx8 AutoStore nvSRAM Document Number: 001-52037				
Revision	ECN	Orig. of Change	Submission Date	Description of Change
**	2668632	GVCH	03/04/2009	New data sheet
*A	2821358	GVCH	12/04/2009	Added Note in Ordering Information mentioning that these parts are not recommended for new designs. Added "Not recommended for New Designs" watermark in the PDF. Added Contents on page 2.

Sales, Solutions, and Legal Information

Worldwide Sales and Design Support

Cypress maintains a worldwide network of offices, solution centers, manufacturer's representatives, and distributors. To find the office closest to you, visit us at cypress.com/sales.

Products

PSoC	psoc.cypress.com
Clocks & Buffers	clocks.cypress.com
Wireless	wireless.cypress.com
Memories	memory.cypress.com
Image Sensors	image.cypress.com

© Cypress Semiconductor Corporation, 2009. The information contained herein is subject to change without notice. Cypress Semiconductor Corporation assumes no responsibility for the use of any circuitry other than circuitry embodied in a Cypress product. Nor does it convey or imply any license under patent or other rights. Cypress products are not warranted nor intended to be used for medical, life support, life saving, critical control or safety applications, unless pursuant to an express written agreement with Cypress. Furthermore, Cypress does not authorize its products for use as critical components in life-support systems where a malfunction or failure may reasonably be expected to result in significant injury to the user. The inclusion of Cypress products in life-support systems application implies that the manufacturer assumes all risk of such use and in doing so indemnifies Cypress against all charges.

Any Source Code (software and/or firmware) is owned by Cypress Semiconductor Corporation (Cypress) and is protected by and subject to worldwide patent protection (United States and foreign), United States copyright laws and international treaty provisions. Cypress hereby grants to licensee a personal, non-exclusive, non-transferable license to copy, use, modify, create derivative works of, and compile the Cypress Source Code and derivative works for the sole purpose of creating custom software and or firmware in support of licensee product to be used only in conjunction with a Cypress integrated circuit as specified in the applicable agreement. Any reproduction, modification, translation, compilation, or representation of this Source Code except as specified above is prohibited without the express written permission of Cypress.

Disclaimer: CYPRESS MAKES NO WARRANTY OF ANY KIND, EXPRESS OR IMPLIED, WITH REGARD TO THIS MATERIAL, INCLUDING, BUT NOT LIMITED TO, THE IMPLIED WARRANTIES OF MERCHANTABILITY AND FITNESS FOR A PARTICULAR PURPOSE. Cypress reserves the right to make changes without further notice to the materials described herein. Cypress does not assume any liability arising out of the application or use of any product or circuit described herein. Cypress does not authorize its products for use as critical components in life-support systems where a malfunction or failure may reasonably be expected to result in significant injury to the user. The inclusion of Cypress' product in a life-support systems application implies that the manufacturer assumes all risk of such use and in doing so indemnifies Cypress against all charges.

Use may be limited by and subject to the applicable Cypress software license agreement.

Looking for pricing, stock, or lifecycle information?

Click below to explore more details on WIN SOURCE:

- ⊖ [View STK14D88-NF35TR on WIN SOURCE](#)
- ⊖ [Cypress Semiconductor Corp Information](#)

Optimize Your Supply Chain with WIN SOURCE Solutions

- ✓ Global Sourcing Solution
- ✓ Obsolete Management
- ✓ Cost Control Management
- ✓ Shortage Management
- ✓ Alternative Solution
- ✓ Excess Inventory Management