



THE DATASHEET OF CYISM560BSXCT



Pin Definitions

Pin	Name	Type	Description
1	Xin/CLK	I	Clock or Crystal connection input. Refer to <i>Table 1</i> for input frequency range selection.
2	VDD	P	Positive power supply.
3	GND	P	Power supply ground.
4	SSCLK	O	Modulated clock output.
5	SSCC	I	Spread Spectrum Clock Control (Enable/Disable) function. SSCG function is enabled when input is high and disabled when input is low. This pin is pulled high internally.
6	S1	I	Tri-level Logic input control pin used to select frequency and bandwidth. Frequency/bandwidth selection and Tri-level Logic programming. See <i>Figure 1</i> .
7	S0	I	Tri-level Logic input control pin used to select frequency and bandwidth. Frequency/bandwidth selection and Tri-level Logic programming. See <i>Figure 1</i> .
8	Xout	O	Oscillator output pin connected to crystal. Leave this pin unconnected if an external clock drives Xin/CLK.

Functional Description

The Cypress SM560 is a Spread Spectrum Clock Generator (SSCG) IC used for the purpose of reducing Electro Magnetic Interference (EMI) found in today's high-speed digital electronic systems.

The SM560 uses a Cypress-proprietary Phase-Locked Loop (PLL) and Spread Spectrum Clock (SSC) technology to synthesize and frequency modulate the input frequency of the reference clock. By frequency modulating the clock, the measured EMI at the fundamental and harmonic frequencies of Clock (SSCLK1) is greatly reduced.

This reduction in radiated energy can significantly reduce the cost of complying with regulatory requirements and time to market without degrading the system performance.

The SM560 is a very simple and versatile device to use. The frequency and spread% range is selected by programming S0 and S1 digital inputs. These inputs use three (3) logic states including High (H), Low (L) and Middle (M) logic levels to select

one of the nine available Frequency Modulation and Spread% ranges. Refer to *Table 1* for programming details.

The SM560 is optimized for SVGA (40 MHz) and XVGA (65 MHz) Controller clocks and also suitable for the applications with the frequency range of 25 to 108 MHz.

A wide range of digitally selectable spread percentages is made possible by using three-level (High, Low and Middle) logic at the S0 and S1 digital control inputs.

The output spread (frequency modulation) is symmetrically centered on the input frequency.

Spread Spectrum Clock Control (SSCC) function enables or disables the frequency spread and is provided for easy comparison of system performance during EMI testing.

The SM560 is available in an eight-pin SOIC package with a 0 to 70°C operating temperature range.

Table 1. Frequency and Spread% Selection (Center Spread)
25 – 54 MHz (Low Range)

Input Frequency (MHz)	S1=M S0=M (%)	S1=M S0=0 (%)	S1=1 S0=0 (%)	S1=0 S0=0 (%)	S1=0 S0=M (%)
25 – 35	3.8	3.2	2.8	2.3	1.9
35 – 40	3.5	3.0	2.5	2.1	1.7
40 – 45	3.2	2.8	2.4	1.9	1.6
45 – 50	3.0	2.6	2.2	1.8	1.5
50 – 54	2.8	2.4	2.0	1.7	1.4

Select the Frequency and Center Spread % desired and then set S1, S0 as indicated.

50 – 108 MHz (High Range)

Input Frequency (MHz)	S1=1 S0=M (%)	S1=0 S0=1 (%)	S1=1 S0=1 (%)	S1=M S0=1 (%)
50 – 60	2.5	1.9	1.2	1.0
60 – 70	2.4	1.8	1.1	0.9
70 – 80	2.3	1.6	1.1	0.9
80 – 100	2.0	1.4	1.0	0.8
100 – 108	1.8	1.3	0.8	0.6

Select the Frequency and Center Spread % desired and then set S1, S0 as indicated.

Tri-level Logic

With binary logic, four states can be programmed with two control lines, whereas Tri-level Logic can program nine logic states using two control lines. Tri-level Logic in the SM560 is implemented by defining a third logic state in addition to the standard logic “1” and “0.” Pins 6 and 7 of the SM560 recognize a logic state by the voltage applied to the respective pin. These states are defined as “0” (Low), “M” (Middle), and

“1” (One). Each of these states has a defined voltage range that is interpreted by the SM560 as a “0,” “M,” or “1” logic state. Refer to *Table 2* for voltage ranges for each logic state. By using two equal value resistors (typically 20K) the “M” state can be easily programmed. Pins 6 or 7 can be tied directly to ground or VDD for Logic “0” or “1” respectively.

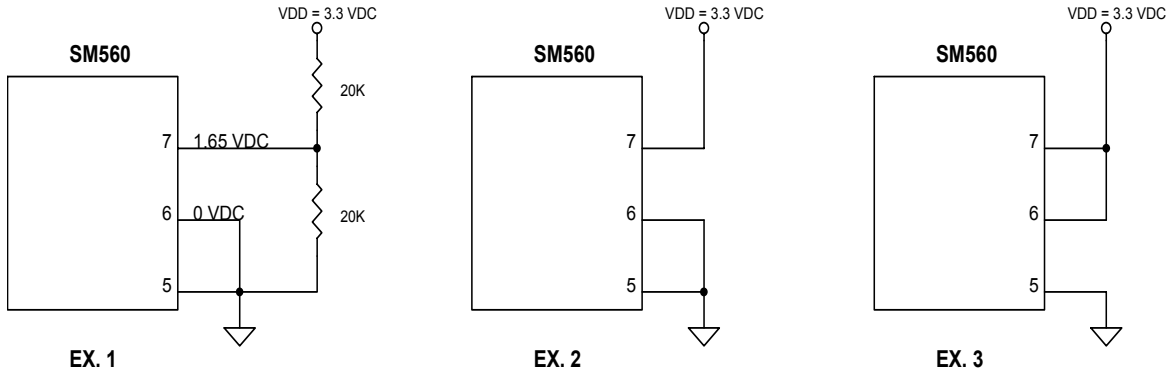

Figure 1.

Absolute Maximum Ratings^[1]

Supply Voltage (V_{DD}): -0.5V to +6.0V Operating Temperature:..... 0°C to 70°C
 DC Input Voltage:.....-0.5V to $V_{DD} + 0.5V$ Storage Temperature..... -65°C to +150°C
 Junction Temperature-40°C to +140°C Static Discharge Voltage (ESD)..... 2,000V-Min.

Table 2. DC Electrical Characteristics: $V_{DD} = 3.3V$, Temp. = 25°C and C_L (Pin 4) = 15 pF, unless otherwise noted

Parameter	Description	Conditions	Min.	Typ.	Max.	Unit
V_{DD}	Power Supply Range	$\pm 10\%$	2.97	3.3	3.63	V
V_{INH}	Input High Voltage	S0 and S1 only	$0.85V_{DD}$	V_{DD}	V_{DD}	V
V_{INM}	Input Middle Voltage	S0 and S1 only	$0.40V_{DD}$	$0.50V_{DD}$	$0.60V_{DD}$	V
V_{INL}	Input Low Voltage	S0 and S1 only	0.0	0.0	$0.15V_{DD}$	V
V_{OH1}	Output High Voltage	$I_{OH} = 6 \text{ mA}$	2.4			V
V_{OH2}	Output High Voltage	$I_{OH} = 20 \text{ mA}$	2.0			V
V_{OL1}	Output Low Voltage	$I_{OH} = 6 \text{ mA}$			0.4	V
V_{OL2}	Output Low Voltage	$I_{OH} = 20 \text{ mA}$			1.2	V
Cin1	Input Capacitance	Xin/CLK (Pin 1)	3	4	5	pF
Cin2	Input Capacitance	Xout (Pin 8)	6	8	10	pF
Cin2	Input Capacitance	S0, S1, SSCG (Pins 7,6,5)	3	4	5	pF
I_{DD1}	Power Supply Current	$F_{IN} = 40 \text{ MHz}$		30	40	mA
I_{DD2}	Power Supply Current	$F_{IN} = 65 \text{ MHz}$		35	45	mA

Table 3. Electrical Timing Characteristics: $V_{DD} = 3.3V$, T = 25°C and $C_L = 15 \text{ pF}$, unless otherwise noted

Parameter	Description	Conditions	Min.	Typ.	Max.	Unit
ICLKFR	Input Clock Frequency Range	$V_{DD} = 3.30V$	25		108	MHz
Trise	Clock Rise Time (Pin 4)	SSCLK1 @ 0.4 – 2.4V	1.2	1.4	1.6	ns
Tfall	Clock Fall Time (Pin 4)	SSCLK1 @ 0.4 – 2.4V	1.2	1.4	1.6	ns
DTYin	Input Clock Duty Cycle	XIN/CLK (Pin 1)	20	50	80	%
DTYout	Output Clock Duty Cycle	SSCLK1 (Pin 4)	45	50	55	%
JCC	Cycle-to-Cycle Jitter	$F_{in} = 25 - 108 \text{ MHz}$	-	125	175	ps

SSCG Theory of Operation

The SM560 is a PLL-type clock generator using a proprietary Cypress design. By precisely controlling the bandwidth of the output clock, the SM560 becomes a Low EMI clock generator. The theory and detailed operation of the SM560 will be discussed in the following sections.

EMI

All digital clocks generate unwanted energy in their harmonics. Conventional digital clocks are square waves with a duty cycle that is very close to 50%. Because of this 50/50-duty cycle, digital clocks generate most of their harmonic energy in the odd harmonics, i.e.; third, fifth, seventh, etc. It is possible to reduce the amount of energy contained in the fundamental and odd harmonics by increasing the bandwidth of the fundamental clock frequency. Conventional digital clocks have a very high Q factor, which means that all of the energy at that frequency is concentrated in a very narrow bandwidth, consequently, higher energy peaks. Regulatory agencies test

Note:

1. **Single Power Supply:** The Voltage on any input or I/O pin cannot exceed the power pin during power up.

electronic equipment by the amount of peak energy radiated from the equipment. By reducing the peak energy at the fundamental and harmonic frequencies, the equipment under test is able to satisfy agency requirements for EMI. Conventional methods of reducing EMI have been to use shielding, filtering, multi-layer PCBs, etc. The SM560 uses the approach of reducing the peak energy in the clock by increasing the clock bandwidth, and lowering the Q.

SSCG

SSCG uses a patented technology of modulating the clock over a very narrow bandwidth and controlled rate of change, both peak and cycle to cycle. The SM560 takes a narrow band digital reference clock in the range of 25–108 MHz and produces a clock that sweeps between a controlled start and stop frequency and precise rate of change. To understand what happens to a clock when SSCG is applied, consider a 65-MHz clock with a 50% duty cycle. From a 65-MHz clock we know the following:

Clock Frequency = $f_c = 65\text{MHz}$
 Clock Period = $T_c = 1/65\text{MHz} = 15.4\text{ns}$

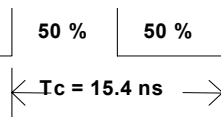

If this clock is applied to the Xin/CLK pin of the SM560, the output clock at pin 4 (SSCLK) will be sweeping back and forth between two frequencies. These two frequencies, F1 and F2, are used to calculate to total amount of spread or bandwidth applied to the reference clock at pin 1. As the clock is making the transition from f1 to f2, the amount of time and sweep waveform play a very important role in the amount of EMI reduction realized from an SSCG clock.

The modulation domain analyzer is used to visualize the sweep waveform and sweep period. The left side of *Figure 2* shows the modulation profile of a 65-MHz SSCG clock. Notice that the actual sweep waveform is not a simple sine or sawtooth waveform. The right side of *Figure 2* is a scan of the same SSCG clock using a spectrum analyzer. In this scan you

can see a 6.48-dB reduction in the peak RF energy when using the SSCG clock.

Modulation Rate

Spectrum Spread Clock Generators utilize frequency modulation (FM) to distribute energy over a specific band of frequencies. The maximum frequency of the clock (Fmax) and minimum frequency of the clock (Fmin) determine this band of frequencies. The time required to transition from Fmin to Fmax and back to Fmin is the period of the Modulation Rate, Tmr. Modulation Rates of SSCG clocks are generally referred to in terms of frequency or Fmod = 1/Tmod.

The input clock frequency, Fin, and the internal divider count, Cdiv, determine the Modulation Rate. In some SSCG clock generators, the selected range determines the internal divider count. In other SSCG clocks, the internal divider count is fixed over the operating range of the part. The SM560 and SM561 have a fixed divider count, as listed below.

Device	Cdiv	
SM560	1166	(All Ranges)
SM561	2332	(All Ranges)

Example:

Device = SM560
 Fin = 65 MHz
 Range = S1 = 1, S0 = M

Then;
 Modulation Rate = Fmod = 65 MHz/1166 = 55.8 kHz.

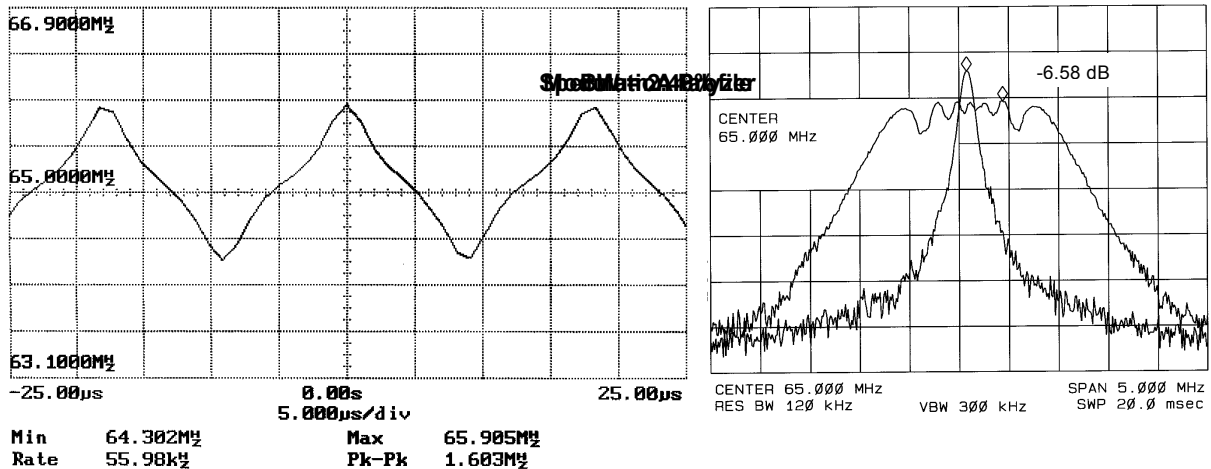
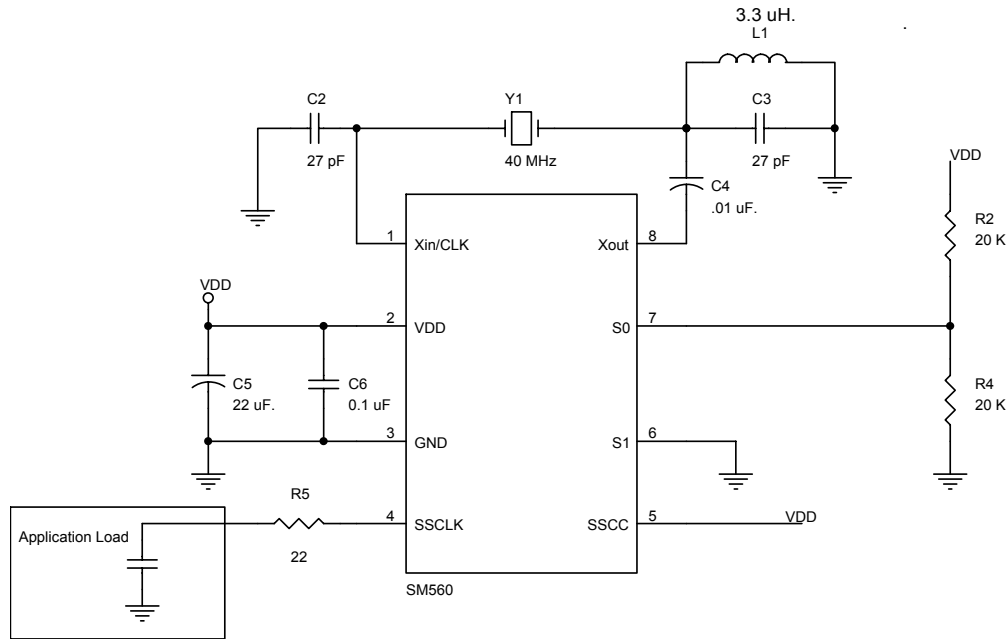

Figure 2. SSCG Clock, SM560, Fin = 65 MHz

SM560 Application Schematic

Figure 3. Application Schematic^[2]

The schematic in *Figure 3* above demonstrates how the SM560 is configured in a typical application. This application is using a 40-MHz reference derived from a third overtone crystal connected to pins 1 and 8. Since Y1 is a third overtone crystal a notch filter is created with L1 and C3 to dampen the gain of the oscillator at the fundamental frequency of this crystal which is 13.33 MHz.

Figure 3 also demonstrates how to properly use the tri-level logic employed in the SM560. Notice that resistors R2 and R4 create a voltage divider that places $V_{DD}/2$ on pin 7 to satisfy the voltage requirement for an “M” state.

With this configuration, the SM560 will produce an SSCG clock that is at a center frequency of 40 MHz. Referring to *Table 2*, range “0, M” at 40 MHz will generate a modulation profile that has a 1.7% peak to peak spread.

Ordering Information^[3]

Part Number	Package Type	Product Flow
IMISM560BZ	8-pin SOIC	Commercial, 0° to 70°C
IMISM560BZT	8-pin SOIC–Tape and Reel	Commercial, 0° to 70°C
Lead Free Devices		
CYISM560BSXC	8-pin SOIC	Commercial, 0° to 70°C
CYISM560BSXCT	8-pin SOIC–Tape and Reel	Commercial, 0° to 70°C

Marking: Example: IMI
SM560BS
Date Code, Lot#

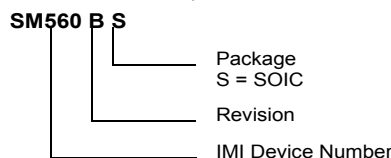
Note:

2. The value of L1 is calculated such that L1 and C3 are tuned to a frequency that is 130% higher than the fundamental frequency of the crystal.

$$ZC1 = 1/2\pi fC$$

$$ZC1 = 1/6.28 (17.33 \text{ MHz}) (27 \text{ pF})$$

$$ZC1 = 340\Omega$$

$$ZL1 = 2\pi fL$$

$$L = ZL1/2\pi f$$

$$L = 340/6.28(17.33 \text{ MHz})$$

$$L = 3.12 \mu\text{H}$$

3. The ordering part number differs from the marking on the actual device.

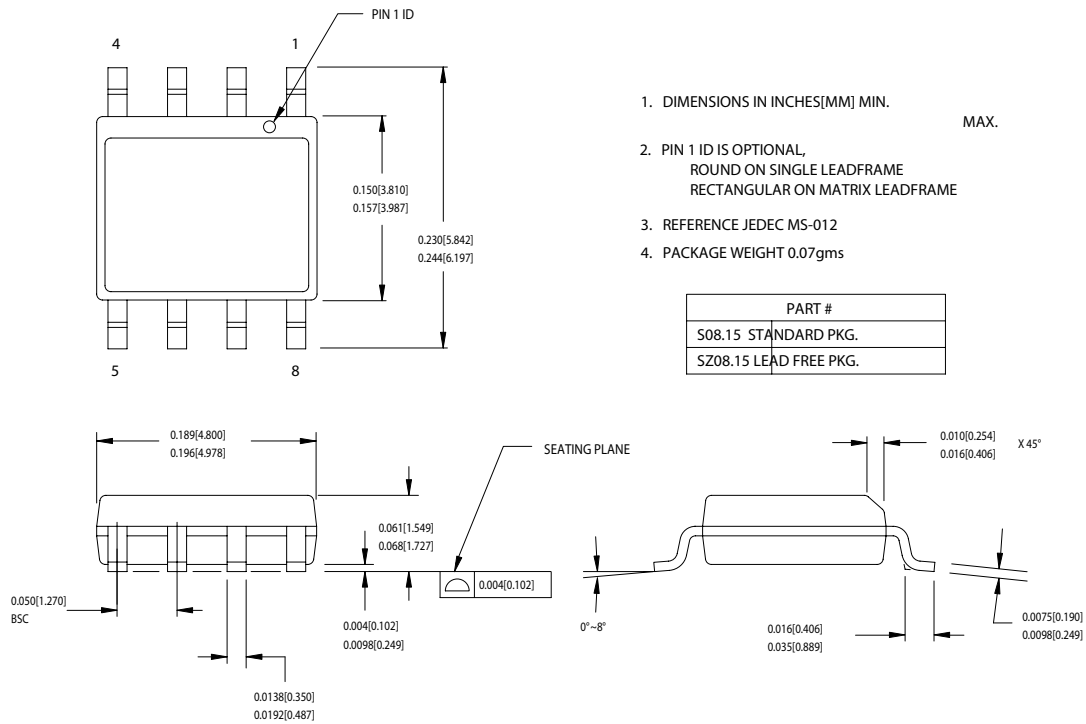
Package Drawing and Dimensions
8-lead (150-Mil) SOIC S8

1. DIMENSIONS IN INCHES[MM] MIN. MAX.
2. PIN 1 ID IS OPTIONAL, ROUND ON SINGLE LEADFRAME RECTANGULAR ON MATRIX LEADFRAME
3. REFERENCE JEDEC MS-012
4. PACKAGE WEIGHT 0.07gms

PART #
S08.15 STANDARD PKG.
SZ08.15 LEAD FREE PKG.



51-85066-°C

Document History Page

Document Title: SM560 Spread Spectrum Clock Generator				
Document Number: 38-07020				
Rev.	ECN No.	Issue Date	Orig. of Change	Description of Change
**	106948	06/07/01	IKA	Convert from IMI to Cypress
*A	113520	04/10/02	DMG	Package suffix changed (per Cypress standard)
*B	119445	10/16/02	RGL	Corrected the values in the Absolute Maximum Ratings to match the device.
*C	122675	12/14/02	RBI	Added power up requirements to operating conditions information.
*D	231055	See ECN	RGL	Added Lead Free Devices
*E	237630	See ECN	RGL	Minor Change: Added letter C in the ordering for Lead Free

Looking for pricing, stock, or lifecycle information?

Click below to explore more details on WIN SOURCE:

-  [View CYISM560BSXCT on WIN SOURCE](#)
-  [Cypress Semiconductor Corp](#) Information

Optimize Your Supply Chain with WIN SOURCE Solutions

-  Global Sourcing Solution
-  Obsolete Management
-  Cost Control Management
-  Shortage Management
-  Alternative Solution
-  Excess Inventory Management