



**THE DATASHEET OF  
SN75LP196PWRG4**



# SN75LP196

## LOW-POWER MULTIPLE RS-232 DRIVERS AND RECEIVERS

SLLS294A – APRIL 1998 – REVISED JUNE 1999

- **Single-Chip RS-232 Interface for an External Modem or Other Computer Peripheral Serial Port**
- **Designed to Transmit and Receive 4- $\mu$ s Pulses (Equivalent to 256 kbit/s)**
- **Wide Driver Supply-Voltage Range: 4.75 V to 15 V**
- **Driver Output Slew Rates Are Controlled Internally to 30 V/ $\mu$ s Maximum**
- **Receiver Input Hysteresis . . . 1000 mV Typical**
- **RS-232 Bus-Pin ESD Protection Exceeds 15 kV Using Human-Body Model (HBM)**
- **Five Drivers and Three Receivers Meet or Exceed the Requirements of TIA/EIA-232-F and ITU v.28 Standards**
- **Complements the SN75LP1185**
- **Designed to Replace the Industry-Standard SN75196 With the Same Flow-Through Pinout**
- **Package Options Include Plastic Small Outline (DW), Shrink Small-Outline (DB), Thin Shrink Small-Outline (PW), and Dual-in-Line (N) Packages**

**DB, DW, N, OR PW PACKAGE  
(TOP VIEW)**

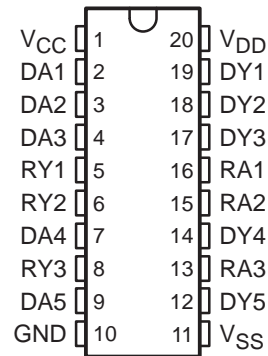

### description

The SN75LP196 is a low-power bipolar device containing five drivers and three receivers, with 15 kV of ESD protection on the bus pins with respect to each other. Bus pins are defined as those pins that tie directly to the serial-port connector, including GND. The pinout matches the flow-through design of the industry-standard SN75196 and allows easy interconnection of the UART and serial-port connector of the IBM PC/AT and compatibles. This device provides a rugged, low-cost solution for this function with the combination of bipolar processing and 15-kV ESD protection.

The SN75LP196 has internal slew-rate control to provide a maximum rate of change in the output signal of 30 V/ $\mu$ s. The driver output swing is clamped nominally at  $\pm 6$  V to enable the higher data rates associated with this device and to reduce EMI emissions. Even though the driver outputs are clamped, they can handle voltages up to  $\pm 15$  V without damage. All the logic inputs can accept 3.3-V or 5-V input signals.

The SN75LP196 complies with the requirements of the TIA/EIA-232-F and the ITU v.28 standards. These standards are for data interchange between a host computer and peripheral at signaling rates up to 20 kbit/s. The switching speeds of the SN75LP196 support rates up to 256 kbit/s with lower capacitive loads (shorter cables).

The SN75LP196 is characterized for operation from 0°C to 70°C.



Please be aware that an important notice concerning availability, standard warranty, and use in critical applications of Texas Instruments semiconductor products and disclaimers thereto appears at the end of this data sheet.

PC/AT is a trademark of IBM Corporation.

PRODUCTION DATA information is current as of publication date. Products conform to specifications per the terms of Texas Instruments standard warranty. Production processing does not necessarily include testing of all parameters.



Copyright © 1999, Texas Instruments Incorporated

# SN75LP196 LOW-POWER MULTIPLE RS-232 DRIVERS AND RECEIVERS

SLLS294A – APRIL 1998 – REVISED JUNE 1999

## Function Tables

### DRIVER

INPUT DA	OUTPUT DY
H	L
L	H
Open	L

### RECEIVER

INPUT RA	OUTPUT RY
H	L
L	H
Open	H

## logic diagram (positive logic)

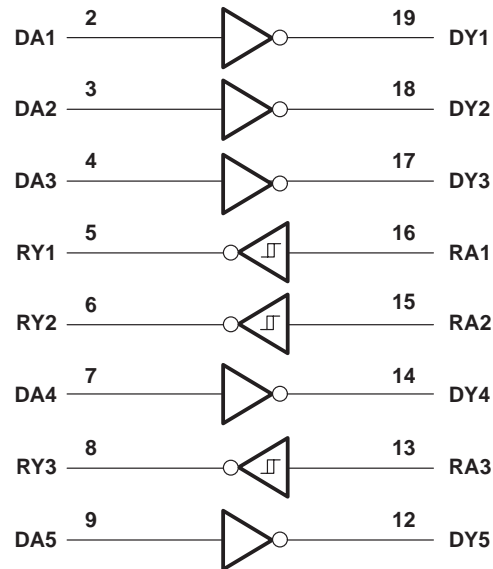

# SN75LP196

## LOW-POWER MULTIPLE RS-232 DRIVERS AND RECEIVERS

SLLS294A – APRIL 1998 – REVISED JUNE 1999

### absolute maximum ratings over operating free-air temperature range (unless otherwise noted)†

Positive supply-voltage range (see Note 1): $V_{CC}$ .....	–0.5 V to 7 V
$V_{DD}$ (see Note 1) .....	–0.5 V to 15 V
Negative supply-voltage range, $V_{SS}$ (see Note 1) .....	0.5 V to –15 V
Input-voltage range, $V_I$ : Receiver (RA) .....	–30 V to 30 V
Driver (DA) .....	–0.5 V to $V_{CC}+0.4$ V
Output-voltage range, $V_O$ : Receiver (RY) .....	–0.5 V to 6 V
Driver (DY) .....	–15 V to 15 V
Electrostatic discharge: Bus pins (human-body model) (see Note 2) .....	Class 3, A: 15 kV
All pins (human-body model) (see Note 2) .....	Class 3, A: 5 kV
All pins (machine model) .....	200 V
Package thermal impedance, $\theta_{JA}$ (see Notes 3 and 4): DB package .....	115°C/W
DW package .....	97°C/W
N package .....	67°C/W
PW package .....	128°C/W
Lead temperature 1,6 mm (1/16 inch) from case for 10 seconds .....	260°C
Storage temperature range, $T_{stg}$ .....	65°C to 150°C

† Stresses beyond those listed under “absolute maximum ratings” may cause permanent damage to the device. These are stress ratings only, and functional operation of the device at these or any other conditions beyond those indicated under “recommended operating conditions” is not implied. Exposure to absolute-maximum-rated conditions for extended periods may affect device reliability.

- NOTES:
1. All voltage values are with respect to network ground terminal, unless otherwise noted.
  2. Per MIL-STD-883 Method 3015.7
  3. Maximum power dissipation is a function of  $T_J(\max)$ ,  $\theta_{JA}$ , and  $T_A$ . The maximum allowable power dissipation at any allowable ambient temperature is  $P_D = (T_J(\max) - T_A)/\theta_{JA}$ . Operating at the absolute maximum  $T_J$  of 150°C can impact reliability.
  4. The package thermal impedance is calculated in accordance with JESD 51, except for through-hole packages, which use a trace length of zero.

### recommended operating conditions

		MIN	NOM	MAX	UNIT
$V_{CC}$	Supply voltage (see Note 5)	4.75	5	5.25	V
$V_{DD}$	Supply voltage (see Note 6)	9	12	15	V
$V_{SS}$	Supply voltage (see Note 6)	–9	–12	–15	V
$V_{IH}$	High-level input voltage				V
					DA
					2
$V_{IL}$	Low-level input voltage				V
					DA
					0.8
$V_I$	Receiver input voltage				V
					RA
					–25
					25
$I_{OH}$	High-level output current				mA
					RY
					–1
$I_{OL}$	Low-level output current				mA
					RY
					2
$T_A$	Operating free-air temperature				°C
					0
					70

- NOTES:
5.  $V_{CC}$  cannot be greater than  $V_{DD}$ .
  6. The device operates down to  $V_{DD} = V_{CC}$  and  $|V_{SS}| = V_{CC}$ , but supply currents increase and other parameters may vary slightly from the data-sheet limits.



# SN75LP196

## LOW-POWER MULTIPLE RS-232 DRIVERS AND RECEIVERS

SLLS294A – APRIL 1998 – REVISED JUNE 1999

### supply currents over the recommended operating conditions (unless otherwise noted)

PARAMETER	TEST CONDITIONS	MIN	TYP	MAX	UNIT
Supply current for $V_{CC}$ , $I_{CC}$	$V_{DD} = 9\text{ V}$ , $V_{SS} = -9\text{ V}$			1000	$\mu\text{A}$
	$V_{DD} = 12\text{ V}$ , $V_{SS} = -12\text{ V}$			1000	
Supply current for $V_{DD}$ , $I_{DD}$	$V_{DD} = 9\text{ V}$ , $V_{SS} = -9\text{ V}$			800	$\mu\text{A}$
	$V_{DD} = 12\text{ V}$ , $V_{SS} = -12\text{ V}$			800	
Supply current for $V_{SS}$ , $I_{SS}$	$V_{DD} = 9\text{ V}$ , $V_{SS} = -9\text{ V}$			-800	$\mu\text{A}$
	$V_{DD} = 12\text{ V}$ , $V_{SS} = -12\text{ V}$			-800	

### driver electrical characteristics over the recommended operating conditions (unless otherwise noted)

PARAMETER	TEST CONDITIONS	MIN	TYP	MAX	UNIT	
$V_{OH}$ High-level output voltage	$V_{IL} = 0.8\text{ V}$ , $R_L = 3\text{ k}\Omega$ , See Figure 1	$V_{DD} = 9\text{ V}$ , $V_{SS} = -9\text{ V}$ , See Note 7	5	5.8	6.6	V
		$V_{DD} = 12\text{ V}$ , $V_{SS} = -12\text{ V}$ , See Note 8	5	5.8	6.6	
$V_{OL}$ Low-level output voltage	$V_{IH} = 2\text{ V}$ , $R_L = 3\text{ k}\Omega$ , See Figure 1	$V_{DD} = 9\text{ V}$ , $V_{SS} = -9\text{ V}$ , See Note 7	-5	-5.8	-6.9	V
		$V_{DD} = 12\text{ V}$ , $V_{SS} = -12\text{ V}$ , See Note 8	-5	-5.8	-6.9	
$I_{IH}$ High-level input current	$V_I$ at $V_{CC}$			1	$\mu\text{A}$	
$I_{IL}$ Low-level input current	$V_I$ at GND			-1	$\mu\text{A}$	
$I_{OS(H)}$ Short-circuit high-level output current	$V_O = \text{GND or } V_{SS}$ . See Figure 2 and Note 9		-30	-55	mA	
$I_{OS(L)}$ Short-circuit low-level output current	$V_O = \text{GND or } V_{DD}$ . See Figure 2 and Note 9		30	55	mA	
$r_o$ Output resistance	$V_{DD} = V_{SS} = V_{CC} = 0$ , $V_O = -2\text{ V to } 2\text{ V}$	300			$\Omega$	

- NOTES: 7. Minimum RS-232 driver output voltages are not attained with  $\pm 5\text{-V}$  supplies. With  $V_{DD}$  less than  $V_{CC} + 2\text{ V}$ , the supply currents may increase. For RS-232 compliant output swings and minimum power consumption,  $V_{DD} \geq V_{CC} + 2\text{ V}$ .
8. Maximum output swing is nominally clamped at  $\pm 6\text{ V}$  to enable the higher data rates associated with this device and to reduce EMI emissions. The driver outputs may slightly exceed the maximum output voltage over the full  $V_{CC}$  and temperature ranges.
9. Not more than one output should be shorted at one time.



# SN75LP196

## LOW-POWER MULTIPLE RS-232 DRIVERS AND RECEIVERS

SLLS294A – APRIL 1998 – REVISED JUNE 1999

### driver switching characteristics over operating free-air temperature range (unless otherwise noted)

PARAMETER		TEST CONDITIONS	MIN	TYP	MAX	UNIT
t <sub>PHL</sub>	Propagation delay time, high- to low-level output	R <sub>L</sub> = 3 kΩ to 7 kΩ, C <sub>L</sub> = 15 pF, See Figure 1	300	800	1600	ns
t <sub>PLH</sub>	Propagation delay time, low- to high-level output	R <sub>L</sub> = 3 kΩ to 7 kΩ, C <sub>L</sub> = 15 pF, See Figure 1	300	800	1600	ns
t <sub>TLH</sub>	Transition time, low- to high-level output	V <sub>CC</sub> = 5 V, V <sub>DD</sub> = 12 V, V <sub>SS</sub> = -12 V, R <sub>L</sub> = 3 kΩ to 7 kΩ, See Figure 1 and Note 10 Using V <sub>TR</sub> = 10%-to-90% transition region, Driver speed = 250 kbit/s, C <sub>L</sub> = 15 pF	375		2240	ns
		Using V <sub>TR</sub> = ±3 V transition region, Driver speed = 250 kbit/s, C <sub>L</sub> = 15 pF	200		1500	
		Using V <sub>TR</sub> = ±3 V transition region, Driver speed = 125 kbit/s, C <sub>L</sub> = 2500 pF			2750	
t <sub>THL</sub>	Transition time, high- to low-level output	V <sub>CC</sub> = 5 V, V <sub>DD</sub> = 12 V, V <sub>SS</sub> = -12 V, R <sub>L</sub> = 3 kΩ to 7 kΩ, See Figure 1 and Note 10 Using V <sub>TR</sub> = 10%-to-90% transition region, Driver speed = 250 kbit/s, C <sub>L</sub> = 15 pF	375		2240	ns
		Using V <sub>TR</sub> = ±3 V transition region, Driver speed = 250 kbit/s, C <sub>L</sub> = 15 pF	200		1500	
		Using V <sub>TR</sub> = ±3 V transition region, Driver speed = 125 kbit/s, C <sub>L</sub> = 2500 pF			2750	
SR	Output slew rate	V <sub>CC</sub> = 5 V, V <sub>DD</sub> = 12 V, V <sub>SS</sub> = -12 V, Using V <sub>TR</sub> = ±3 V transition region, Driver speed = 0 to 250 kbit/s, C <sub>L</sub> = 15 pF	4	20	30	V/μs

NOTE 10: Maximum output swing is limited to ±6 V to enable the higher data rates associated with this device and to reduce EMI emissions.

### receiver electrical characteristics over recommended operating free-air temperature range (unless otherwise noted)

PARAMETER		TEST CONDITIONS	MIN	TYP	MAX	UNIT
V <sub>IT+</sub>	Positive-going input threshold voltage	See Figure 3	1.6	2	2.55	V
V <sub>IT-</sub>	Negative-going input threshold voltage	See Figure 3	0.6	1	1.45	V
V <sub>HYS</sub>	Input hysteresis, V <sub>IT+</sub> V <sub>IT-</sub>	See Figure 3	750	1000		mV
V <sub>OH</sub>	High-level output voltage	I <sub>OH</sub> = -1 mA	2.5	3.9		V
V <sub>OL</sub>	Low-level output voltage	I <sub>OL</sub> = 2 mA		0.33	0.5	V
I <sub>IH</sub>	High-level input current	V <sub>I</sub> = 3 V	0.43	0.6	1	mA
		V <sub>I</sub> = 25 V	3.6	5.1	8.3	
I <sub>IL</sub>	Low-level input current	V <sub>I</sub> = 3 V	-0.43	-0.6	-1	mA
		V <sub>I</sub> = 25 V	-3.6	-5.1	-8.3	
I <sub>OS(H)</sub>	Short-circuit high-level output current	V <sub>O</sub> = 0, See Figure 5 and Note 9			-20	mA
I <sub>OS(L)</sub>	Short-circuit low-level output current	V <sub>O</sub> = V <sub>CC</sub> , See Figure 5 and Note 9			20	mA
R <sub>IN</sub>	Input resistance	V <sub>I</sub> = ±3 V to ±25 V	3	5	7	kΩ

NOTE 9: Not more than one output should be shorted at one time.



# SN75LP196 LOW-POWER MULTIPLE RS-232 DRIVERS AND RECEIVERS

SLLS294A – APRIL 1998 – REVISED JUNE 1999

receiver switching characteristics over operating free-air temperature range,  $C_L = 50$  pF (unless otherwise noted) (see Figure 4)

PARAMETER		MIN	TYP	MAX	UNIT
$t_{PHL}$	Propagation delay time, high- to low-level output		400	900	ns
$t_{PLH}$	Propagation delay time, low- to high-level output		400	900	
$t_{TLH}$	Transition time, low- to high-level output		200	450	ns
$t_{THL}$	Transition time, high- to low-level output		200	400	
$t_{sk(p)}$	Pulse skew $ t_{PLH} - t_{PHL} $		200	425	ns

## PARAMETER MEASUREMENT INFORMATION

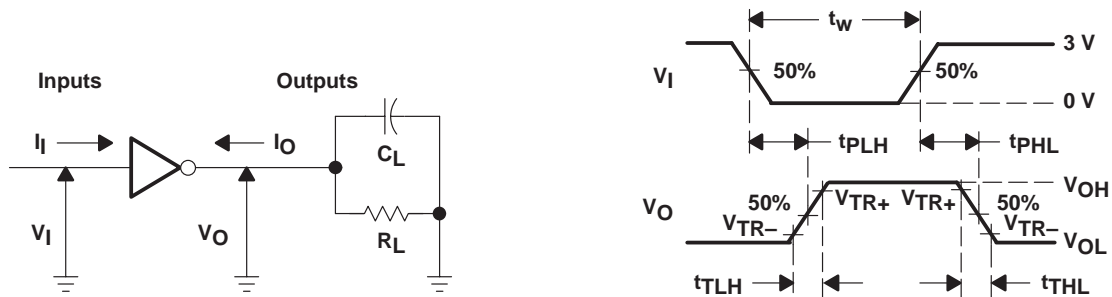

- NOTES: A. The pulse generator has the following characteristics:  
 For  $C_L < 1000$  pF:  $t_w = 4 \mu s$ , PRR = 250 kbit/s,  $Z_O = 50 \Omega$ ,  $t_r = t_f < 50$  ns.  
 For  $C_L = 2500$  pF:  $t_w = 8 \mu s$ , PRR = 125 kbit/s,  $Z_O = 50 \Omega$ ,  $t_r = t_f < 50$  ns.  
 B.  $C_L$  includes probe and jig capacitance.

Figure 1. Driver Parameter Test Circuit and Waveform

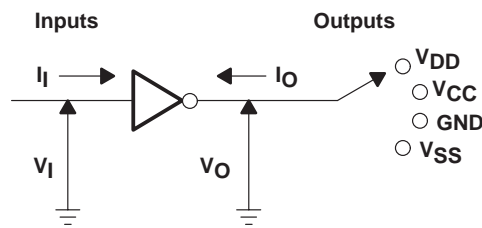

Figure 2. Driver  $I_{OS}$  Test

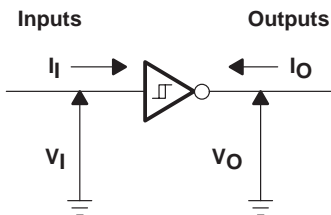
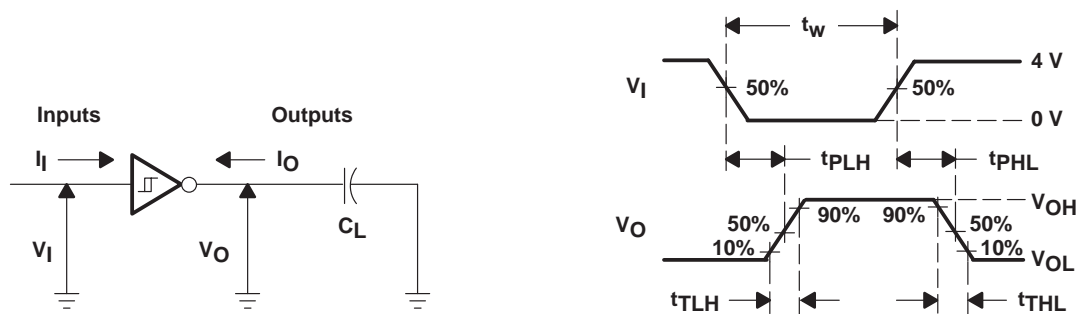

Figure 3. Receiver  $V_{IT}$  Test

**PARAMETER MEASUREMENT INFORMATION**



NOTES: A. The pulse generator has the following characteristics:  $t_w = 4 \mu s$ , PRR = 250 kbit/s,  $Z_O = 50 \Omega$ ,  $t_r = t_f < 50 ns$ .  
B.  $C_L$  includes probe and jig capacitance.

**Figure 4. Receiver Parameter Test Circuit and Waveform**

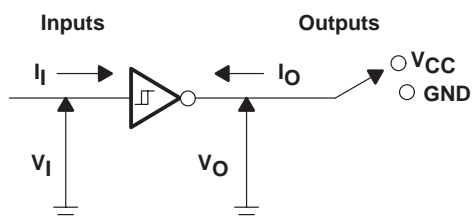

**Figure 5. Receiver  $I_{OS}$  Test**

**APPLICATION INFORMATION**

Diodes placed in series with the  $V_{DD}$  and  $V_{SS}$  leads protect the SN75LP196 in the fault condition in which the device outputs are shorted to  $\pm 15 V$  and the power supplies are at low voltage and provide low-impedance paths to ground (see Figure 6).

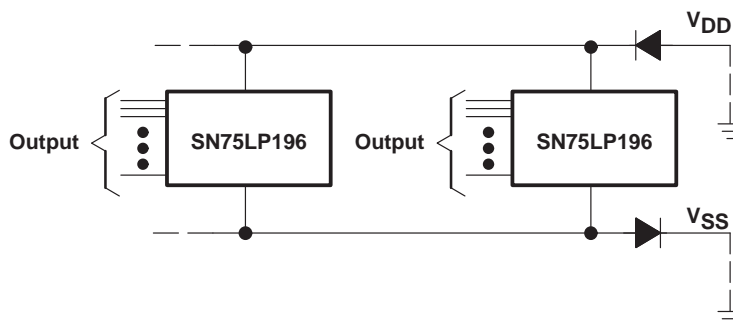

**Figure 6. Power-Supply Protection to Meet Power-Off Fault Conditions of EIA/TIA-232-F**

## IMPORTANT NOTICE

Texas Instruments and its subsidiaries (TI) reserve the right to make changes to their products or to discontinue any product or service without notice, and advise customers to obtain the latest version of relevant information to verify, before placing orders, that information being relied on is current and complete. All products are sold subject to the terms and conditions of sale supplied at the time of order acknowledgement, including those pertaining to warranty, patent infringement, and limitation of liability.

TI warrants performance of its semiconductor products to the specifications applicable at the time of sale in accordance with TI's standard warranty. Testing and other quality control techniques are utilized to the extent TI deems necessary to support this warranty. Specific testing of all parameters of each device is not necessarily performed, except those mandated by government requirements.

CERTAIN APPLICATIONS USING SEMICONDUCTOR PRODUCTS MAY INVOLVE POTENTIAL RISKS OF DEATH, PERSONAL INJURY, OR SEVERE PROPERTY OR ENVIRONMENTAL DAMAGE ("CRITICAL APPLICATIONS"). TI SEMICONDUCTOR PRODUCTS ARE NOT DESIGNED, AUTHORIZED, OR WARRANTED TO BE SUITABLE FOR USE IN LIFE-SUPPORT DEVICES OR SYSTEMS OR OTHER CRITICAL APPLICATIONS. INCLUSION OF TI PRODUCTS IN SUCH APPLICATIONS IS UNDERSTOOD TO BE FULLY AT THE CUSTOMER'S RISK.

In order to minimize risks associated with the customer's applications, adequate design and operating safeguards must be provided by the customer to minimize inherent or procedural hazards.

TI assumes no liability for applications assistance or customer product design. TI does not warrant or represent that any license, either express or implied, is granted under any patent right, copyright, mask work right, or other intellectual property right of TI covering or relating to any combination, machine, or process in which such semiconductor products or services might be or are used. TI's publication of information regarding any third party's products or services does not constitute TI's approval, warranty or endorsement thereof.

## Looking for pricing, stock, or lifecycle information?

Click below to explore more details on WIN SOURCE:

 [View SN75LP196PWRG4 on WIN SOURCE](#)

 [Texas Instruments](#) Information

## Optimize Your Supply Chain with WIN SOURCE Solutions

-  Global Sourcing Solution
-  Obsolete Management
-  Cost Control Management
-  Shortage Management
-  Alternative Solution
-  Excess Inventory Management