



**THE DATASHEET OF
SI5356A-B05152-GMR**





SKYWORKS®

Si5356A

I²C PROGRAMMABLE, ANY-FREQUENCY 1–200 MHz, QUAD FREQUENCY 8-OUTPUT CLOCK GENERATOR

Features

- Generates any frequency from 1 to 200 MHz on each of the 4 output banks
- Programmable frequency configuration
- Guaranteed 0 ppm frequency synthesis error for any combination of frequencies
- 25 or 27 MHz xtal or 5–200 MHz input clk
- Eight CMOS clock outputs
- Easy-to-use programming software
- Configurable “triple A” spread spectrum: any clock, any frequency, and with any spread amount
- Programmable output phase adjustment with <20 ps error
- Interrupt pin indicates LOS or LOL
- OEB pin disables all outputs or per bank OEB control via I²C
- Low jitter: 50 ps pk-pk (typ), 75 ps pk-pk period jitter (max)
- Excellent PSRR performance eliminates need for external power supply filtering
- Low power: 45 mA (core)
- Core VDD: 1.8, 2.5, or 3.3 V
- Separate VDDO for each bank of outputs: 1.8, 2.5, or 3.3 V
- Small size: 4x4 mm 24-QFN
- Industrial temperature range: –40 to +85 °C

Applications

- Printers
- Audio/video
- DSLAM
- Storage area networks
- Switches/routers
- Servers

Description

The Si5356 is a highly flexible, I²C programmable clock generator capable of synthesizing four completely non-integer related frequencies up to 200 MHz. The device has four banks of outputs with each bank supporting two CMOS outputs at the same frequency. Using Skyworks Solutions' patented MultiSynth fractional divider technology, all outputs are guaranteed to have 0 ppm frequency synthesis error regardless of configuration, enabling the replacement of multiple clock ICs and crystal oscillators with a single device. Each output bank is independently configurable to support 1.8, 2.5, or 3.3 V. The device is programmable via an I²C/SMBus-compatible serial interface and supports operation from a 1.8, 2.5, or 3.3 V core supply.

Functional Block Diagram

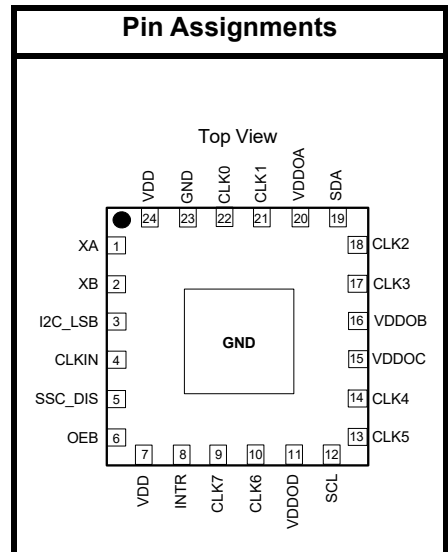

TABLE OF CONTENTS

Section	Page
1. Electrical Specifications	3
2. Typical Application Circuits	7
3. Functional Description	8
3.1. Overview	8
3.2. Input Configuration	9
3.3. Breakthrough MultiSynth Technology	9
3.4. Frequency Configuration	10
3.5. Configuring the Si5356	10
3.6. Output Phase Adjustment	12
3.7. CMOS Output Drivers	12
3.8. Jitter Performance	12
3.9. Status Indicators	13
3.10. I2C Interface	14
3.11. Spread Spectrum	15
3.12. Power Supply Considerations	17
4. Si5356 Registers	18
5. Pin Descriptions	19
6. Ordering Guide	22
6.1. Evaluation Board	22
7. Package Outline: 24-Lead QFN	23
8. Recommended PCB Land Pattern	24
9. Top Marking	25
9.1. Si5356A Top Marking	25
9.2. Top Marking Explanation	25
10. Device Errata	26
Document Change List	27
Contact Information	28

1. Electrical Specifications

Table 1. Recommended Operating Conditions
 $(V_{DD} = 1.8\text{ V} -5\% \text{ to } +10\%, 2.5 \text{ or } 3.3\text{ V} \pm 10\%, T_A = -40 \text{ to } 85\text{ }^\circ\text{C})$

Parameter	Symbol	Test Condition	Min	Typ	Max	Unit
Ambient Temperature	T_A		-40	—	85	$^\circ\text{C}$
Core Supply Voltage	V_{DD}		2.97	3.3	3.63	V
			2.25	2.5	2.75	
			1.71	1.8	1.98	
Output Buffer Supply Voltage	V_{DDO}		1.71	—	3.63	V

Note: All minimum and maximum specifications are guaranteed and apply across the recommended operating conditions. Typical values apply at nominal supply voltages and an operating temperature of 25 $^\circ\text{C}$ unless otherwise noted.

Table 2. DC Characteristics
 $(V_{DD} = 1.8\text{ V} -5\% \text{ to } +10\%, 2.5 \text{ or } 3.3\text{ V} \pm 10\%, T_A = -40 \text{ to } 85\text{ }^\circ\text{C})$

Parameter	Symbol	Test Condition	Min	Typ	Max	Unit
Core Supply Current	I_{DD}	100 MHz on all outputs, 25 MHz refclk	—	45	60	mA
Output Buffer Supply Current	I_{DDOx}	CMOS, 50 MHz 15 pF load	—	6	9	mA
		CMOS, 200 MHz 3.3 V V_{DDO}	—	13	18	mA
		CMOS, 200 MHz 2.5 V	—	10	14	mA
		CMOS, 200 MHz 1.8 V	—	7	10	mA
High Level Input Voltage	V_{IH}	CLKIN, I2C_LSB	$0.8 \times V_{DD}$	—	3.63	V
		SSC_DIS, OEB	0.85	—	1.3	V
Low Level Input Voltage	V_{IL}	CLKIN, I2C_LSB	-0.2	—	$0.2 \times V_{DD}$	V
		SSC_DIS, OEB	—	—	0.3	V
Clock Output High Level Output Voltage	V_{OH}	Pins: CLK0–7 $I_{OH} = -4\text{ mA}$	$V_{DDO} - 0.3$	—	—	V
Clock Output Low Level Output Voltage	V_{OL}	Pins: CLK0–7 $I_{OL} = +4\text{ mA}$	—	—	0.3	V
INTR Low Level Output Voltage	V_{OLINTR}	Pin: INTR $I_{OL} = +3\text{ mA}$	0	—	0.4	V
SSC_DIS, OEB Input Resistance	R_{IN}		—	20	—	$\text{k}\Omega$

Si5356A

Table 3. AC Characteristics

($V_{DD} = 1.8\text{ V} -5\%$ to $+10\%$, 2.5 or $3.3\text{ V} \pm 10\%$, $T_A = -40$ to $85\text{ }^\circ\text{C}$)

Parameter	Symbol	Test Condition	Min	Typ	Max	Unit
Input Clock						
Clock Input Frequency	F_{IN}		5	—	200	MHz
Clock Input Rise/Fall Time	T_R/T_F	20–80% V_{DD}	—	—	2.3	ns
		10–90% V_{DD}	—	—	4	ns
Clock Input Duty Cycle	DC	Input tr/ff within specified limits shown above	40	—	60	%
Clock Input Capacitance	C_{IN}		—	2	—	pF
Output Clocks						
Clock Output Frequency	F_O		1	—	200	MHz
Clock Output Frequency Synthesis Resolution	F_{RES}	See "3.4. Frequency Configuration" on page 10	0	0	1	ppb
Output Load Capacitance	C_L		—	—	15	pF
Clock Output Rise/Fall Time	T_R/T_F	20 to 80% V_{DD} , $C_L = 15\text{ pF}$	—	—	2.0	ns
Clock Output Rise/Fall Time	T_R/T_F	20 to 80% V_{DD} , $C_L = 2\text{ pF}$	—	0.45	0.85	ns
Clock Output Duty Cycle	DC	Measured at $V_{DD}/2$	45	50	55	%
Powerup Time	T_{PU}	POR to output clock valid	—	—	2	ms
Output Enable Time	T_{OE}		—	—	10	μs
Output-Output Skew	T_{SKEW}	Outputs at same frequency, $f_{OUT} > 5\text{ MHz}$	–150	—	+150	ps
Period Jitter	J_{PPKPK}	10000 cycles*	—	50	75	ps pk-pk
Cycle-Cycle Jitter	J_{CCPK}	10000 cycles*	—	40	70	ps pk
Phase Jitter	J_{PH}	12 kHz to 20 MHz	—	2	—	ps rms
PLL Loop Bandwidth	F_{BW}		—	1.6	—	MHz
Interrupt Status Timing						
CLKIN Loss of Signal Assert Time	t_{LOS}		—	2.6	5	μs
CLKIN Loss of Signal Deassert Time	t_{LOS_b}		0.01	0.2	1	μs
*Note: Measured in accordance to JEDEC Standard 65.						

Table 4. Crystal Specifications

Parameter	Symbol	Test Condition	Min	Typ	Max	Unit
Crystal Frequency	F_{XTAL}	Option 1	—	25	—	MHz
		Option 2	—	27	—	MHz
Load Capacitance (on-chip differential)	c_L (supported)*		11	12	13	pF
	c_L (recommended)		17	18	19	pF
Crystal Output Capacitance	C_O		—	—	5	pF
Equivalent Series Resistance	ESR	25 MHz	—	—	100	Ω
		27 MHz	—	—	75	Ω
Crystal Drive Level Rating	d_L		100	—	—	μ W

***Note:** See "AN360: Crystal Selection Guide for Si533x and Si5355/56 Devices" for how to adjust the registers to accommodate a 12 pF crystal C_L

Table 5. I²C Specifications (SCL,SDA)¹

Parameter	Symbol	Test Condition	Standard Mode		Fast Mode		Unit
			Min	Max	Min	Max	
LOW level input voltage	V_{IL2C}		-0.5	$0.3 \times V_{DDI2C}$	-0.5	$0.3 \times V_{DDI2C}^2$	V
HIGH level input voltage	V_{IH2C}		$0.7 \times V_{DDI2C}$	3.63	$0.7 \times V_{DDI2C}^2$	3.63	V
Hysteresis of Schmitt trigger inputs	V_{HYS}		N/A	N/A	0.1	—	V
LOW level output voltage (open drain or open collector) at 3 mA sink current	V_{OL2C}^2	$V_{DDI2C}^2 = 2.5/3.3$ V	0	0.4	0	0.4	V
		$V_{DDI2C}^2 = 1.8$ V	N/A	N/A	0	$0.2 \times V_{DDI2C}$	V
Input current	I_{I2C}		-10	10	-10	10	μ A
Capacitance for each I/O pin	C_{I2C}	$V_{IN} = -0.1$ to V_{DDI2C}	—	4	—	4	pF
I ² C Bus timeout	—		25	35	25	35	ms

Notes:

1. Refer to NXP's UM10204 I²C-bus specification and user manual, revision 03, for further details.
2. Only I²C pull up voltages (V_{DDI2C}) of 1.71 to 3.63 V are supported. Must write register 27[7] = 1 if the I²C bus voltage is less than 2.25 V.

Si5356A

Table 6. Thermal Conditions

Parameter	Symbol	Test Condition	Value	Unit
Thermal Resistance Junction to Ambient	θ_{JA}	Still Air	37	°C/W
Thermal Resistance Junction to Case	θ_{JC}	Still Air	25	°C/W

Table 7. Absolute Maximum Ratings^{1,2,3}

Parameter	Symbol	Rating	Unit
Supply Voltage Range	V_{DD}	-0.5 to +3.8	V
Input Voltage Range (all pins except pins 1,2,5,6)	V_I	-0.5 to 3.8	V
Input Voltage Range (pins 1,2,5,6)	V_{I2}	-0.5 to 1.3	V
Output Voltage Range	V_O	-0.5 to $V_{DD} + 0.3$	V
Junction Temperature	T_J	-55 to +150	°C
ESD Tolerance	HBM	2.5	kV
	CDM	550	V
	MM	175	V
Latch-up Tolerance	LU	JESD78 Compliant	
Soldering Temperature (Pb-free profile) ⁴	T_{PEAK}	260	°C
Soldering Temperature Time at T_{PEAK} (Pb-free profile) ⁴	T_P	20–40	sec

Notes:

1. Permanent device damage may occur if the Absolute Maximum Ratings are exceeded. Functional operation should be restricted to the conditions as specified in the operational sections of this data sheet. Exposure to maximum rating conditions for extended periods may affect device reliability.
2. 24-QFN package is RoHS compliant.
3. For more packaging information, go to https://www.skyworksinc.com/Product_Certificate.aspx.
4. The device is compliant with JEDEC J-STD-020.

2. Typical Application Circuits



3. Functional Description



3.1. Overview

The Si5356 is a highly flexible, I²C programmable clock generator capable of synthesizing four independent frequencies up to 200 MHz. The device has four banks of outputs with each bank supporting two CMOS outputs at the same frequency. The Si5356 supports free-running mode of operation using an external crystal, or it can lock to an external clock for generating synchronous clocks. The output drivers support 1.8, 2.5, and 3.3 V CMOS formats, and each output bank is independently configurable. Adjustable output-to-output phase offsets are also available to compensate for PCB trace delays or for fine tuning of setup and hold margins.

Configuration and control of the Si5356 is handled through the I²C/SMBus interface. The device also provides the option of storing a user-definable clock configuration in its non-volatile memory (NVM), which becomes the default clock configuration power-up. See section "3.5.1. Ordering a Custom NVM Configuration" on page 11 for details.

3.1.1. ClockBuilder™ Desktop Software

To simplify device configuration, Skyworks Solutions has released the ClockBuilder Desktop. The software serves two purposes: to configure the Si5356 with optimal configuration based on the desired frequencies, and to control the EVB, when connected to a host PC.

The optimal configuration can be saved from the software in text files that can be used in any system, which configures the device over I²C. ClockBuilder Desktop can be downloaded from <https://www.skyworksinc.com/en/application-pages/clockbuilder-pro-software> and runs on Windows XP, Windows Vista, and Windows 7. Additionally, an NVM file can be generated using the NVM→Save for Factory Programming... menu option. An NVM file can be used by factory to prepare custom pre-programmed devices.

3.2. Input Configuration

The Si5356 input can be driven from either an external crystal or a reference clock. If the crystal input option is used, the Si5356 operates as a free-running clock generator. In this mode of operation the device requires a low cost 25 or 27 MHz fundamental mode crystal connected across XA and XB as shown in Figure 1. Given the Si5356's frequency flexibility, the same crystal can be reused to generate any combination of output frequencies. Custom frequency crystals are not required. The Si5356 integrates the crystal load capacitors on-chip to reduce external component count. The crystal should be placed very close to the device to minimize stray capacitance. To ensure a stable and accurate output frequency, the recommended crystal specifications provided in Table 4 on page 5 must be followed. See AN360 for additional details regarding crystal recommendations.

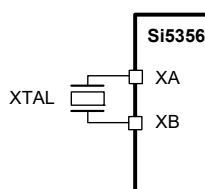

Figure 1. Connecting an XTAL to the Si5356

For synchronous timing applications, the Si5356 can lock to a 5 to 200 MHz CMOS reference clock. A typical interface circuit is shown in Figure 2. A series termination resistor matching the driver's output impedance to the impedance of the transmission line is recommended to reduce reflections.



Figure 2. Interfacing CMOS Reference Clocks to the Si5356

Control input signals to SSC_DIS and OEB cannot exceed 1.3 V yet also need to meet the V_{OH} and V_{OL} specifications outlined in Table 2 on page 3. When these inputs are driven from CMOS sources, a resistive attenuator as shown in the Typical Application Circuits must be used. Suggested standard 1% resistor values for RSE and RSH, when using a CMOS source, are given below.

CMOS Level	RSE ohms	RSH ohms
1.8 V	1000	1580
2.5 V	1960	1580
3.3 V	3090	1580

3.3. Breakthrough MultiSynth Technology

Modern timing architectures require a wide range of frequencies which are often non-integer related. Traditional clock architectures address this by using a combination of single PLL ICs, 4-PLL ICs and discrete XOs, often at the expense of BOM complexity and power. The Si5356 use patented MultiSynth technology to dramatically simplify timing architectures by integrating the frequency synthesis capability of 4 phase-locked loops (PLLs) in a single device, greatly minimizing size and power requirements versus traditional solutions. Based on a fractional-N PLL, the heart of the architecture is a low phase noise, high-frequency VCO. The VCO supplies a high frequency output clock to the MultiSynth block on each of the four independent output paths. Each MultiSynth operates as a high-speed fractional divider with Skyworks Solutions' proprietary phase error correction to divide down the VCO clock to the required output frequency with very low jitter.

The first stage of the MultiSynth architecture is a fractional-N divider which switches seamlessly between the two closest integer divider values to produce the exact output clock frequency with 0 ppm error. To eliminate phase error generated by this process, MultiSynth calculates the relative phase difference between the clock produced by the fractional-N divider and the desired output clock and dynamically adjusts the phase to match the ideal clock waveform. This novel approach makes it possible to generate any output clock frequency without sacrificing jitter performance. Based on this architecture, each clock output can produce any frequency from 1 to 200 MHz.



Figure 3. Skyworks Solutions' MultiSynth Technology

3.4. Frequency Configuration

The Si5356 utilizes a single PLL-based architecture, four independent MultiSynth fractional output dividers, and a MultiSynth fractional feedback divider such that a single device provides the clock generation capability of four independent PLLs. Unlike competitive multi-PLL solutions, the Si5356 can generate four unique non-integer related output frequencies with 0 ppm frequency error, with respect to the reference, for any combination of output frequencies. In addition, any combination of output frequencies can be generated from a single reference frequency without having to change the crystal or reference clock frequency between configurations.

Frequency configurations are fully programmable by writing to device registers using the I²C interface. Any combination of output frequencies ranging from 1 to 200 MHz can be configured on each of the device outputs.

3.5. Configuring the Si5356

The Si5356 is a highly-flexible clock generator that is entirely configurable through its I²C interface. The device's default configuration is stored in non-volatile memory (NVM) as shown in Figure 4. The NVM is a one-time programmable memory (OTP), which can store a custom user configuration at power-up. This is a useful feature for applications that need a clock present at power-up (e.g., for providing a clock to a processor).



Figure 4. Si5356 Memory Configuration

During a power cycle or a power-on reset (POR), the contents of the NVM are copied into random access memory (RAM), which sets the device configuration that will be used during operation. Any changes to the device configuration after power-up are made by reading and writing to registers in the RAM space through the I²C interface. ClockBuilder Desktop (see "3.1.1. ClockBuilder™ Desktop Software" on page 8) can be used to easily configure register map files that can be written into RAM (see "3.5.2. Creating a New Configuration for RAM" for details). Alternatively, the register map file can be created manually with the help of the equations in AN565.

Two versions of the Si5356 are available. First, non-customized Si5356 devices are available in which the RAM can be configured in-circuit via I²C. These blank Si5356 devices can also be field programmed using the Si5338/56-PROG-EVB (see "3.5.4. Writing a Custom Configuration to NVM"). Second, custom factory-programmed Si5356 devices are available that include a user-specified startup frequency configuration (example part number Si5356A-Axxxxx-GM).

3.5.1. Ordering a Custom NVM Configuration

The Si5356 is orderable with a factory-programmed custom NVM configuration. This is the simplest way of using the Si5356 since it generates the desired output frequencies at power-up or after a power-on reset (POR). This default configuration can be reconfigured in RAM through the I²C interface after power-up (see “3.5.2. Creating a New Configuration for RAM”).

The first step in ordering a custom device is generating an NVM file which defines the input and output clock frequencies and signal formats. This is easily done using the NVM→Save for Factory Programming... menu option in ClockBuilder Desktop. (See “3.1.1. ClockBuilder™ Desktop Software” on page 8.) This Windows based software allows the user to generate an NVM file, which is used by the factory to manufacture custom parts. Each custom part is marked with a unique part number identifying the specific configuration (e.g., Si5356A-A00100-GM).

Consult your local sales representative for more details on ordering a custom Si5356.

3.5.2. Creating a New Configuration for RAM

Any Si5356 device can be configured by writing to registers in RAM through the I²C interface. A non-factory programmed device must be configured in this manner.

When creating a custom RAM configuration, use the following procedure:

1. Create a device configuration (register map) using ClockBuilder Desktop (v3.0 or later; see “3.1.1. ClockBuilder™ Desktop Software” on page 8) or manually using the equations in “AN565: Configuring the Si5356A”.
 - a. Configure the frequency plan.
 - b. Configure the output driver format and supply voltage.
 - c. Configure initial phase offset (if desired).
 - d. Configure spread spectrum (if desired).
2. Save the configuration using the Options > Save Register Map File or Options > Save C code Header File, or create the register contents by the conversions listed in AN565.

At this point, the new configuration can be written to the device RAM according to the instructions in “3.5.3. Writing a Custom Configuration to RAM”.

3.5.3. Writing a Custom Configuration to RAM

Writing a new configuration (register map) to the RAM consists of pausing the LOL state-machine, writing new values to the IC accounting for the write-allowed mask given in AN565, validating the input clock or crystal, locking the PLL to the input with the new configuration, restarting the LOL state-machine, and calibrating the VCO for robust operation across temperature. The flow chart in Figure 5 on page 12 enumerates the details:

Note: The write-allowed mask specifies which bits must be read and modified before writing the entire register byte (a.k.a. read-modify-write). “AN428: Jump Start: In-System, Flash-Based Programming for Skyworks Solutions’ Timing Products” illustrates the procedure defined in Section 3.5.2 with ANSI C code.



Figure 5. I²C Programming Procedure

3.5.4. Writing a Custom Configuration to NVM

An alternative to ordering an Si5356 with a custom NVM configuration is to use the field programming kit (Si5338/56-PROG-EVB) to write directly to the NVM of a "blank" Si5356. Since NVM is an OTP memory, it can only be written once. The default configuration can be reconfigured by writing to RAM through the I²C interface (see "3.5.2. Creating a New Configuration for RAM").

3.6. Output Phase Adjustment

The Si5356 has a digitally-controlled phase adjustment feature that allows the user to adjust the phase of each output clock in relation to the other output clocks. The phase of each output clock can be adjusted with an error of <20 ps over a range of ±45 ns. This feature is available on any clock output that does not have Spread Spectrum enabled.

3.7. CMOS Output Drivers

The Si5356 has 4 banks of outputs with each bank comprised of 2 clocks for a total of 8 CMOS outputs per device. By default, each bank of CMOS output clocks are in-phase. Alternatively, each output clock can be inverted. This feature enables each output pair to operate as a differential CMOS clock. Each of the output banks can operate from a different VDDO supply

(1.8 V, 2.5 V, 3.3 V), simplifying usage in mixed supply applications.

The CMOS output driver has a controlled impedance of close to 50 Ω, which includes an internal 22 Ω series resistor. An external series resistor is not needed when driving 50 Ω traces. If higher impedance traces are used then a series resistor may be added. A typical configuration is shown in Figure 6.

3.8. Jitter Performance

The Si5356 provides consistently low jitter for any combination of output frequencies. The device leverages a low phase noise single PLL architecture and Skyworks Solutions' patented MultiSynth fractional output divider technology to deliver excellent jitter performance guaranteed across process, temperature and voltage. The Si5356 provides superior performance to traditional multi-PLL solutions which may suffer from degraded jitter performance depending on frequency plan and the number of active PLLs.

3.9. Status Indicators

An open-drain interrupt pin (INTR) is available to indicate a loss of signal (LOS) condition, a PLL loss of lock (LOL) condition, or that the PLL is in the process of acquiring lock (SYS_CAL). As shown in Figure 7, a status register at address 218 is available to help identify the exact event that caused the interrupt pin to become active. A LOS condition occurs when there is no clock input to the Si5356. The loss of lock algorithm works by continuously monitoring the frequency difference between the two inputs of the phase frequency detector. When this frequency difference is greater than about 1000 ppm, a loss of lock condition is declared. Note that the VCO will track the input clock frequency for up to approximately 25000 ppm, which will keep the inputs to the phase frequency detector at the same frequency until the PLL comes out of lock. When a clock input is removed, the interrupt pin will assert, and the clock outputs may drift up to 5%. When the input clock is reapplied with an appropriate frequency, the PLL will again lock.

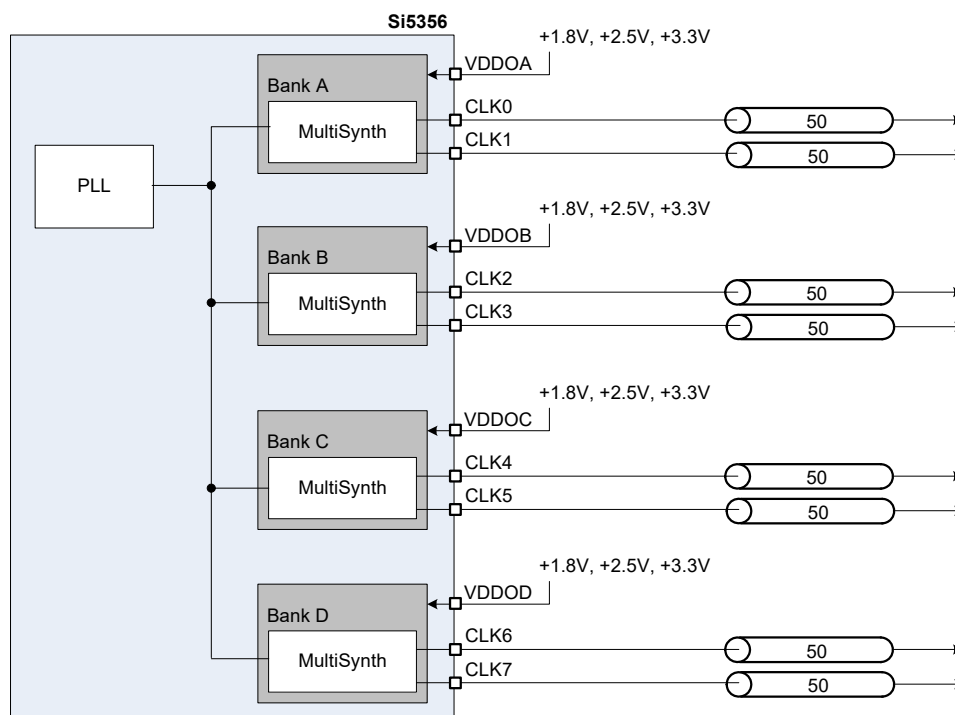

Figure 6. CMOS Output Driver Configuration

Si5356A

3.10. I²C Interface

The Si5356 control interface is a 2-wire bus for bidirectional communication. The bus consists of a bidirectional serial data line (SDA) and a serial clock input (SCL). The device operates as a slave device on the 2-wire bus and is compatible with I²C specifications. Both lines must be connected to the positive supply via an external pull-up. Standard-Mode (100 kbps) and Fast-Mode (400 kbps) operation and 7-bit addressing are supported as specified in the I²C-Bus Specification standard. To accommodate multiple Si5356 devices on the same I²C bus, the Si5356 has pin 3 as I2C_LSB. The complete 7-bit I2C bus address for the device is 70h or 71h depending upon the state of the I2C_LSB pin. In binary, this is written as 111 000[I2C_LSB]. See Figure 8 for the command format for both read and write access.

Data is always sent MSB first. Table 5 includes the AC and DC electrical parameters for the SCL and SDA I/Os, respectively. The timing specifications and timing diagram for the I²C bus can be found in the I²C-Bus Specification standard. SDA timeout support is supported for compatibility with SMBus interfaces.

The I²C interface is 3.3 V tolerant.

The I²C bus can be operated at a bus voltage of 1.71 to 3.63 V and should have a pullup resistor as recommended by the I²C-Bus Specification. If the I²C bus voltage is less than 2.25 V, register 27[7] must be set to 1.



Figure 7. Status Register



Figure 8. I²C/SMBus-Compatible Command Format

3.11. Spread Spectrum

To help reduce electromagnetic interference (EMI), the Si5356A supports spread spectrum modulation. The output clock frequencies can be modulated to spread energy across a broader range of frequencies, lowering system EMI. The Si5356A implements spread spectrum using its patented MultiSynth technology to achieve previously unattainable precision in both modulation rate and spreading magnitude as shown in Figure 9. Through I²C control, the Spread Spectrum can be applied to any output clock, any clock frequency, and any spread amount from $\pm 0.1\%$ to $\pm 2.5\%$ center spread and -0.1% to -5% down spread.

The spreading rate is limited to 30 to 63 kHz.

The Spread Spectrum is generated digitally in the output MultiSynths which means that the Spread Spectrum parameters are virtually independent of process, voltage, and temperature variations. Since the Spread Spectrum is created in the output MultiSynths, through I²C each output channel can have independent Spread Spectrum parameters. Without the use of I²C (NVM download only) the only supported Spread Spectrum parameters are for PCI Express compliance composing 100 MHz clock, 31.5 kHz spreading frequency with the choice of the spreading.

Rev A devices provide native support for both down and center spread. Center spread is supported in rev B devices by up-shifting the nominal frequency and using down-spread register parameters. Consult AN565 for details.

Note: If you currently use center spread on a revision A and would like to migrate to a revision B device, you must generate a new register map using either ClockBuilder Desktop or the equations in AN565. Center spread configurations for Revisions A and B are **not** compatible.



Figure 9. Configurable Spread Spectrum

3.12. Power Supply Considerations

The Si5356 has two core supply voltage pins (V_{DD}) and four clock output bank supply voltage pins (V_{DDOA} – V_{DDOD}), enabling the device to be used in mixed supply applications. The Si5356 does not require ferrite beads for power supply filtering. The device has extensive on-chip power supply regulation to minimize the impact of power supply noise on output jitter. Figure 10 is a curve of additive phase jitter with power supply noise. Note that even when a significant amount of noise is applied to the device power supply, additive phase jitter is still very small.



Figure 10. Peak-to-Peak Additive Phase Jitter from 100 mV Sine Wave on Supply

Si5356A

4. Si5356 Registers

For many applications, the Si5356's register values are easily configured using ClockBuilder Desktop (see "3.1.1. ClockBuilder™ Desktop Software" on page 8). However, for customers interested in using the Si5356 in operating modes beyond the capabilities available with ClockBuilder, refer to "AN565: Configuring the Si5356A" for a detailed description of the Si5356 registers and their usage. Also refer to "AN428: Jump Start: In-System, Flash-Based Programming for Skyworks Solutions' Timing Products" for a working application example of register programming using the Skyworks Solutions' C8051F301 MCU.

5. Pin Descriptions



Note: Center pad must be tied to GND for normal operation.

Table 8. Si5356 Pin Descriptions

Pin #	Pin Name	I/O	Description
1	XA	I	External Crystal. If a 25 or 27 MHz crystal is used as the device frequency reference, connect it across XA and XB. If no input clock is used, this pin should be tied to GND.
2	XB	I	External Crystal. If a 25 or 27 MHz crystal is used as the device frequency reference, connect it across XA and XB. If no input clock is used, this pin should be tied to GND.
3	I2C_LSB	I	I²C LSB Address Bit (3.3 V Tolerant). This pin is the least significant bit of the Si5356 I ² C address allowing up to two Si5356 devices to occupy the same I ² C bus.
4	CLKIN	I	Single-Ended Input Clock. If a single-ended clock is used as the device frequency reference, connect it to this pin. This pin functions as a high-impedance input for CMOS clock signals. The input should be dc coupled. If a crystal is used as the device frequency reference, this pin should be tied to GND.

Table 8. Si5356 Pin Descriptions (Continued)

5	SSC_DIS	I	<p>Spread Spectrum Disable.</p> <p>This pin allows disabling of the spread spectrum feature on the output clocks. Note that the maximum voltage level on this pin must not exceed 1.3 V. To disable spread spectrum connect this pin to a voltage of 0.85 to 1.3 V. Connect to GND to enable spread spectrum. A resistor voltage divider is recommended when controlled by a signal greater than 1.3 V. See the Typical Application Circuit for details.</p>
6	OEB	I	<p>Output Enable (Active Low).</p> <p>This pin allows disabling the output clocks. Note that the maximum voltage level on this pin must not exceed 1.3 V. To disable all outputs connect this pin to a voltage of 0.85 to 1.3 V. Connect to GND to enable all outputs. A resistor voltage divider is recommended when controlled by a signal greater than 1.3 V. See the Typical Application Circuit for details.</p>
7	VDD	VDD	<p>Core Supply Voltage.</p> <p>The device operates from a 1.8, 2.5, or 3.3 V supply. A 0.1 μF bypass capacitor should be located very close to this pin.</p>
8	INTR	O	<p>Interrupt.</p> <p>A typical pullup resistor of 1–4 kΩ should be used on this pin. This pin functions as an maskable interrupt output. 0 = No interrupt 1 = Interrupt present This pin is open drain and requires an external ≥ 1 kΩ pullup resistor.</p>
9	CLK7	O	<p>Output Clock 7.</p> <p>CMOS output clock. If unused, this pin must be left floating.</p>
10	CLK6	O	<p>Output Clock 6.</p> <p>CMOS output clock. If unused, this pin must be left floating.</p>
11	VDDOD	VDD	<p>Clock Output Bank D Supply Voltage.</p> <p>Power supply for clock outputs 6 and 7. May be operated from a 1.8, 2.5, or 3.3 V supply. A 0.1 μF bypass capacitor should be located very close to this pin. If CLK6/7 are not used, this pin must be tied to pin 7 and/or pin 24 or a voltage rail ≥ 1.5 V.</p>
12	SCL	I	<p>I²C Serial Clock Input (3.3 V Tolerant).</p>
13	CLK5	O	<p>Output Clock 5.</p> <p>CMOS output clock. If unused, this pin must be left floating.</p>
14	CLK4	O	<p>Output Clock 4.</p> <p>CMOS output clock. If unused, this pin must be left floating.</p>
15	VDDOC	VDD	<p>Clock Output Bank C Supply Voltage.</p> <p>Power supply for clock outputs 4 and 5. May be operated from a 1.8, 2.5 or 3.3 V supply. A 0.1 μF bypass capacitor should be located very close to this pin. If CLK4/5 are not used, this pin must be tied to pin 7 and/or pin 24 or a voltage rail ≥ 1.5 V.</p>
16	VDDOB	VDD	<p>Clock Output Bank B Supply Voltage.</p> <p>Power supply for clock outputs 2 and 3. May be operated from a 1.8, 2.5, or 3.3 V supply. A 0.1 μF bypass capacitor should be located very close to this pin. If CLK2/3 are not used, this pin must be tied to pin 7 and/or pin 24 or a voltage rail ≥ 1.5 V.</p>

Table 8. Si5356 Pin Descriptions (Continued)

17	CLK3	O	Output Clock 3. CMOS output clock. If unused, this pin must be left floating.
18	CLK2	O	Output Clock 2. CMOS output clock. If unused, this pin must be left floating.
19	SDA	I/O	I²C Serial Data (3.3 V Tolerant).
20	VDDOA	VDD	Clock Output Bank A Supply Voltage. Power supply for clock outputs 0 and 1. May be operated from a 1.8, 2.5, or 3.3 V supply. A 0.1 μ F bypass capacitor should be located very close to this pin. If CLK0/1 are not used, this pin must be tied to pin 7 and/or pin 24 or a voltage rail \geq 1.5 V.
21	CLK1	O	Output Clock 1. CMOS output clock. If unused, this pin must be left floating.
22	CLK0	O	Output Clock 0. CMOS output clock. If unused, this pin must be left floating.
23	GND	GND	Ground. Must be connected to system ground. Minimize the ground path impedance for optimal performance of the device.
24	VDD	VDD	Core Supply Voltage. The device operates from a 1.8, 2.5, or 3.3 V supply. A 0.1 μ F bypass capacitor should be located very close to this pin.
GND PAD	GND	GND	Ground Pad. This is the large pad in the center of the package. The device will not function unless the ground pad is properly connected to a ground plane on the PCB. See "8. Recommended PCB Land Pattern" on page 24 for the PCB pad sizes and ground via requirements.

Si5356A

6. Ordering Guide



6.1. Evaluation Board

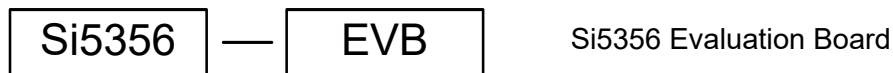

7. Package Outline: 24-Lead QFN

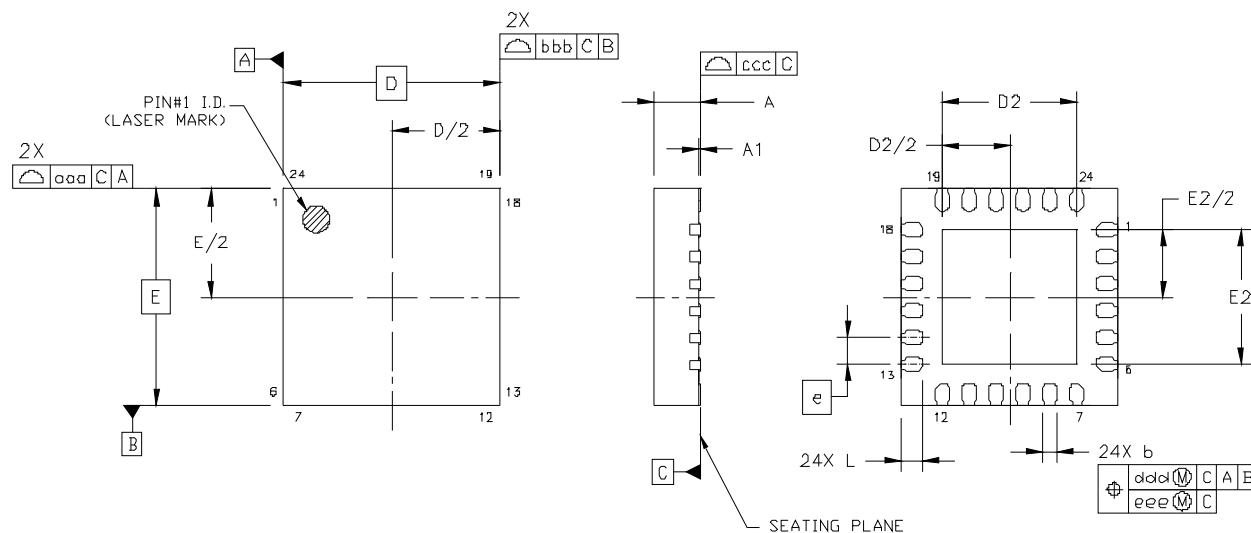

Figure 11. 24-Lead Quad Flat No-Lead (QFN)

Table 9. Package Dimensions

Dimension	Min	Nom	Max
A	0.80	0.85	0.90
A1	0.00	0.02	0.05
b	0.18	0.25	0.30
D	4.00 BSC.		
D2	2.35	2.50	2.65
e	0.50 BSC.		
E	4.00 BSC.		
E2	2.35	2.50	2.65
L	0.30	0.40	0.50
aaa	0.10		
bbb	0.10		
ccc	0.08		
ddd	0.10		
eee	0.05		

Notes:

1. All dimensions shown are in millimeters (mm) unless otherwise noted.
2. Dimensioning and Tolerancing per ANSI Y14.5M-1994.
3. This drawing conforms to the JEDEC Outline MO-220, variation VGGD-8.
4. Recommended card reflow profile is per the JEDEC/IPC J-STD-020 specification for Small Body Components.
5. Terminal base alloy: Cu.
6. Terminal plating/grid array material: Au/NiPd.
7. For more packaging information, go to https://www.skyworksinc.com/Product_Certificate.aspx.

8. Recommended PCB Land Pattern



Table 10. PCB Land Pattern

Dimension	Min	Nom	Max
P1	2.50	2.55	2.60
P2	2.50	2.55	2.60
X1	0.20	0.25	0.30
Y1	0.75	0.80	0.85
C1		3.90	
C2		3.90	
E		0.50	

Notes:

General

1. All dimensions shown are in millimeters (mm) unless otherwise noted.
2. Dimensioning and Tolerancing per ANSI Y14.5M-1994 specification.
3. This Land Pattern Design is based on the IPC-7351 guidelines.
4. Connect the center ground pad to a ground plane with no less than five vias. These 5 vias should have a length of no more than 20 mils to the ground plane. Via drill size should be no smaller than 10 mils. A longer distance to the ground plane is allowed if more vias are used to keep the inductance from increasing.

Solder Mask Design

5. All metal pads are to be non-solder mask defined (NSMD). Clearance between the solder mask and the metal pad is to be 60 μm minimum, all the way around the pad.

Stencil Design

6. A stainless steel, laser-cut and electro-polished stencil with trapezoidal walls should be used to assure good solder paste release.
7. The stencil thickness should be 0.125 mm (5 mils).
8. The ratio of stencil aperture to land pad size should be 1:1 for all perimeter pins.
9. A 2x2 array of 1.0 mm square openings on 1.25 mm pitch should be used for the center ground pad.

Card Assembly

10. A No-Clean, Type-3 solder paste is recommended.
11. The recommended card reflow profile is per the JEDEC/IPC J-STD-020 specification for Small Body Components.

9. Top Marking

9.1. Si5356A Top Marking

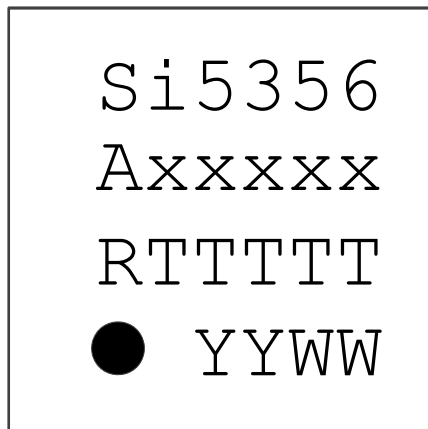

9.2. Top Marking Explanation

Mark Method:	Laser	
Line 1 Marking:	Device Part Number	Si5356
Line 2 Marking:	A = Frequency and configuration code. I ² C programmable, any-frequency 1–200 MHz, quad frequency, 8-output clock generator. xxxxx = NVM code for custom factory- programmed devices (characters are not included for blank devices). See Ordering Guide section in data sheet for more information.	Axxxxx
Line 3 Marking:	R = Product revision. TTTTT = Manufacturing trace code.	RTTTTT
Line 4 Marking:	Pin 1 indicator.	Circle with 0.5 mm diameter; left-justified
	YY = Year. WW = Work week. Characters correspond to the year and work week of package assembly.	YYWW

10. Device Errata

Please visit www.skyworksinc.com to access the device errata document.

DOCUMENT CHANGE LIST

Revision 0.1 to Revision 0.2

- Improved specification details on input signals.
- Added phase and cycle-cycle jitter specifications.
- Added thermal resistance junction to case.
- Improved application circuits.
- Added GND via requirement details.
- Added differential CMOS capability.

Revision 0.2 to Revision 0.3

- Added Section “3.1. Overview”
- Updated Section “3.2. Input Configuration”
- Updated Section “3.4. Frequency Configuration”
- Added Section “3.5. Configuring the Si5356”
- Added Section “4. Si5356 Registers”
- Added Section “9. Top Marking”
- Updated “Figure 10. Peak-to-Peak Additive Phase Jitter from 100 mV Sine Wave on Supply”

Revision 0.3 to Revision 1.0

- Renamed part number on page header from Si5356 to Si5356A.
- Updated Table 2. DC Characteristics.
 - Added IDDOx specification.
 - Corrected Pn Input Resistance specification.
- Updated Table 3, “AC Characteristics,” on page 4.
 - Added 10–90% input clock rise/fall time.
 - Added LOS assert/deassert time.
 - Added note on jitter test.
 - Updated 20–80% rise/fall time with $C_L = 15$ pF for output clocks to the maximum value of 2.0 ns.
 - Changed Frequency Synthesis Resolution spec to the correct value of 1ppb max.
- Updated recommended crystal load parameters in Table 4 on page 5.
- Updated Table 6 on page 6.
 - Added Soldering profile specification
 - Corrected Input Voltage Range (V_{I2}) to 1.3 V (max).
 - Added packaging/RoHS information.
- Removed section “3.5.4. Modifying a MultiSynth Output Divider Ratio/Frequency Configuration.”
- Removed output-to-output skew spec from text in section “3.7. CMOS Output Drivers” to prevent duplicating spec in “Table 3. AC Characteristics.”
- Removed jitter spec from text in section “3.8. Jitter Performance” to prevent duplicating spec in “Table 3. AC Characteristics.”
- Added Evaluation Board information to the Ordering Guide.

Revision 1.0 to Revision 1.1

- Updated Figure 5 on page 12 to provide workaround for spread spectrum errata.
- Added “ Document Change List” on page 27.

Revision 1.1 to Revision 1.2

- Removed down spread spectrum errata that has been corrected in Revision B.
- Updated ordering information to refer to Revision B silicon.
- Updated top marking explanation in table.
- Added further explanation to describe revision-specific behavior of center spread spectrum in Section 3.11

Revision 1.2 to Revision 1.3

- Added link to errata document.

Revision 1.3 to Revision 1.4

- Removed MSL rating.



SKYWORKS®

ClockBuilder Pro

Customize Skyworks clock generators, jitter attenuators and network synchronizers with a single tool. With CBPro you can control evaluation boards, access documentation, request a custom part number, export for in-system programming and more!

www.skyworksinc.com/CBPro



Portfolio

www.skyworksinc.com/ia/timing



SW/HW

www.skyworksinc.com/CBPro



Quality

www.skyworksinc.com/quality



Support & Resources

www.skyworksinc.com/support

Copyright © 2021 Skyworks Solutions, Inc. All Rights Reserved.

Information in this document is provided in connection with Skyworks Solutions, Inc. ("Skyworks") products or services. These materials, including the information contained herein, are provided by Skyworks as a service to its customers and may be used for informational purposes only by the customer. Skyworks assumes no responsibility for errors or omissions in these materials or the information contained herein. Skyworks may change its documentation, products, services, specifications or product descriptions at any time, without notice. Skyworks makes no commitment to update the materials or information and shall have no responsibility whatsoever for conflicts, incompatibilities, or other difficulties arising from any future changes.

No license, whether express, implied, by estoppel or otherwise, is granted to any intellectual property rights by this document. Skyworks assumes no liability for any materials, products or information provided hereunder, including the sale, distribution, reproduction or use of Skyworks products, information or materials, except as may be provided in Skyworks' Terms and Conditions of Sale.

THE MATERIALS, PRODUCTS AND INFORMATION ARE PROVIDED "AS IS" WITHOUT WARRANTY OF ANY KIND, WHETHER EXPRESS, IMPLIED, STATUTORY, OR OTHERWISE, INCLUDING FITNESS FOR A PARTICULAR PURPOSE OR USE, MERCHANTABILITY, PERFORMANCE, QUALITY OR NON-INFRINGEMENT OF ANY INTELLECTUAL PROPERTY RIGHT; ALL SUCH WARRANTIES ARE HEREBY EXPRESSLY DISCLAIMED. SKYWORKS DOES NOT WARRANT THE ACCURACY OR COMPLETENESS OF THE INFORMATION, TEXT, GRAPHICS OR OTHER ITEMS CONTAINED WITHIN THESE MATERIALS. SKYWORKS SHALL NOT BE LIABLE FOR ANY DAMAGES, INCLUDING BUT NOT LIMITED TO ANY SPECIAL, INDIRECT, INCIDENTAL, STATUTORY, OR CONSEQUENTIAL DAMAGES, INCLUDING WITHOUT LIMITATION, LOST REVENUES OR LOST PROFITS THAT MAY RESULT FROM THE USE OF THE MATERIALS OR INFORMATION, WHETHER OR NOT THE RECIPIENT OF MATERIALS HAS BEEN ADVISED OF THE POSSIBILITY OF SUCH DAMAGE.

Skyworks products are not intended for use in medical, lifesaving or life-sustaining applications, or other equipment in which the failure of the Skyworks products could lead to personal injury, death, physical or environmental damage. Skyworks customers using or selling Skyworks products for use in such applications do so at their own risk and agree to fully indemnify Skyworks for any damages resulting from such improper use or sale.

Customers are responsible for their products and applications using Skyworks products, which may deviate from published specifications as a result of design defects, errors, or operation of products outside of published parameters or design specifications. Customers should include design and operating safeguards to minimize these and other risks. Skyworks assumes no liability for applications assistance, customer product design, or damage to any equipment resulting from the use of Skyworks products outside of Skyworks' published specifications or parameters.



Skyworks, the Skyworks symbol, Sky5®, SkyOne®, SkyBlue™, Skyworks Green™, Clockbuilder®, DSPLL®, ISOModem®, ProSLIC®, and SiPHY® are trademarks or registered trademarks of Skyworks Solutions, Inc. or its subsidiaries in the United States and other countries. Third-party brands and names are for identification purposes only and are the property of their respective owners. Additional information, including relevant terms and conditions, posted at www.skyworksinc.com, are incorporated by reference.

Skyworks Solutions, Inc. | Nasdaq: SWKS | sales@skyworksinc.com | www.skyworksinc.com

USA: 781-376-3000 | Asia: 886-2-2735 0399 | Europe: 33 (0)1 43548540 | [in](#) [f](#) [t](#) [v](#)

Looking for pricing, stock, or lifecycle information?

Click below to explore more details on WIN SOURCE:

-  [View SI5356A-B05152-GMR on WIN SOURCE](#)
-  [Skyworks Solutions Inc. Information](#)

Optimize Your Supply Chain with WIN SOURCE Solutions

-  Global Sourcing Solution
-  Obsolete Management
-  Cost Control Management
-  Shortage Management
-  Alternative Solution
-  Excess Inventory Management