



**THE DATASHEET OF
SL2125-222KR87-PF**



Radial Lead Inductors(Coils) For Power Line

Conformity to RoHS Directive

SL Series SL2125

FEATURES

- This is a low Rdc, best for the power supply line.
- There is a series of many types from low inductance to high inductance in large current.
- It is a product conforming to RoHS directive.

APPLICATIONS

Televisions, CRT displays, printers, and various types of electronic products.

SPECIFICATIONS

Operating temperature range	-40 to +85°C [Including self-temperature rise]
Storage temperature range	-40 to +85°C [Unit of products]
Terminal strength	9.8N min.
Flow soldering condition	260°C /10 seconds

PRODUCT IDENTIFICATION

SL	2125	-	102	K	1R3	-	PF
(1)	(2)	(3)	(4)	(5)	(6)		

(1)Series name

(2)Dimensions

Type	Dimension	Lead pitch
2125	ø20.8×25.5mm	10mm

(3)Inductance value

102	1000μH
103	10000μH

(4)Inductance tolerance

K	±10%
---	------

(5)Rated current

1R3	1.3A
R41	0.41A

(6)Lead-free compatible product

PF	Lead-free compatible product
----	------------------------------

PACKAGING STYLE AND QUANTITIES

Packaging style	Quantity
Bulk	100 pieces/tray

• Conformity to RoHS Directive: This means that, in conformity with EU Directive 2002/95/EC, lead, cadmium, mercury, hexavalent chromium, and specific bromine-based flame retardants, PBB and PBDE, have not been used, except for exempted applications.

• All specifications are subject to change without notice.

SHAPES AND DIMENSIONS

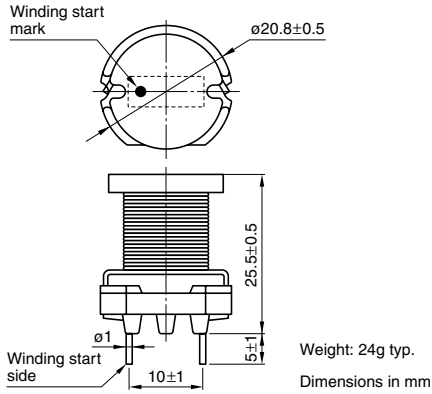

ELECTRICAL CHARACTERISTICS

Inductance (μH)	Inductance tolerance	Test frequency L (kHz)	DC resistance (Ω)max.	Rated current(A)*max.		Part No.
				Based on inductance change	Based on temperature rise	
1000	$\pm 10\%$	1	0.35	1.7	1.3	SL2125-102K1R3-PF
1500	$\pm 10\%$	1	0.61	1.3	0.99	SL2125-152KR99-PF
2200	$\pm 10\%$	1	0.78	1.1	0.87	SL2125-222KR87-PF
3300	$\pm 10\%$	1	1.15	0.95	0.72	SL2125-332KR72-PF
4700	$\pm 10\%$	1	1.71	0.78	0.59	SL2125-472KR59-PF
6800	$\pm 10\%$	1	2.61	0.66	0.47	SL2125-682KR47-PF
10000	$\pm 10\%$	1	3.41	0.55	0.41	SL2125-103KR41-PF

* Rated current: Value obtained when current flows and self-temperature has risen to 25°C.

- Test equipment Inductance: LCR METER YHP4261A, or equivalent
Rdc: MILLIOHM METER VP-2941A MATSUSHITA, or equivalent

TYPICAL ELECTRICAL CHARACTERISTICS

INDUCTANCE CHANGE vs. DC SUPERPOSITION CHARACTERISTICS

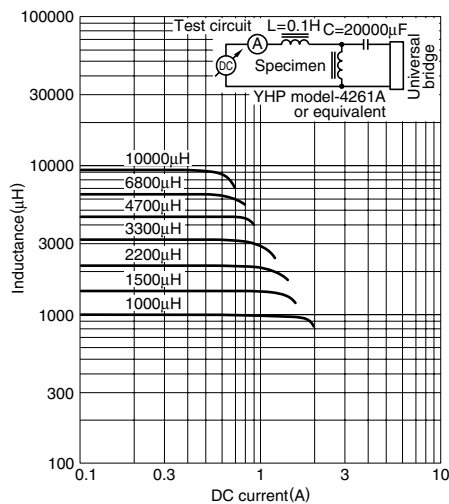

• All specifications are subject to change without notice.

Looking for pricing, stock, or lifecycle information?

Click below to explore more details on WIN SOURCE:

- ⊖ [View SL2125-222KR87-PF on WIN SOURCE](#)
- ⊖ [TDK Corporation Information](#)

Optimize Your Supply Chain with WIN SOURCE Solutions

- ✓ Global Sourcing Solution
- ✓ Obsolete Management
- ✓ Cost Control Management
- ✓ Shortage Management
- ✓ Alternative Solution
- ✓ Excess Inventory Management