

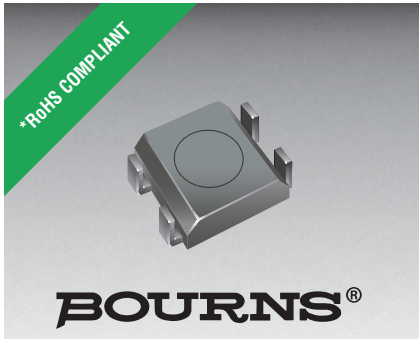

**THE DATASHEET OF
SRR0618-330ML**





Features

- Available in E6 series
- Low unit height of 1.8 mm
- High current
- RoHS compliant*

This series is currently available but not recommended for new designs.

SRR0618 Series - Shielded Power Inductors

Electrical Specifications

Bourns Part No.	Inductance 100kHz		Q Ref.	Test Frequency (kHz)	SRF Nom. (MHz)	RDC Max. (Ω)	I rms Typ. (A)	I sat Typ. (A)
	(μH)	Tol. %						
SRR0618-2R2ML	2.2	± 20	30	100	95	0.05	1.70	2.10
SRR0618-3R3ML	3.3	± 20	30	100	70	0.07	1.40	1.75
SRR0618-4R7ML	4.7	± 20	30	100	65	0.10	1.05	1.45
SRR0618-6R8ML	6.8	± 20	30	100	50	0.15	0.95	1.18
SRR0618-100ML	10.0	± 20	30	100	45	0.22	0.82	0.98
SRR0618-150ML	15.0	± 20	30	100	35	0.31	0.60	0.76
SRR0618-220ML	22.0	± 20	30	100	25	0.46	0.47	0.60
SRR0618-330ML	33.0	± 20	30	100	22	0.68	0.43	0.53
SRR0618-470ML	47.0	± 20	30	100	20	1.10	0.36	0.44
SRR0618-680ML	68.0	± 20	30	100	15	1.50	0.30	0.37
SRR0618-101ML	100.0	± 20	30	100	13	2.30	0.23	0.27

General Specifications

Test Voltage0.1 Volt
 Reflow Soldering230 °C, 50 sec max.
 Operating Temperature ..-40 °C to +125 °C
 (Temperature rise included)
 Storage Temperature...-40 °C to +125 °C
 Resistance to Soldering Heat
260 °C for 10 sec.

Materials

Core Material.....Ferrite DR
 WireEnameled Copper
 BaseFerrite Core
 Terminal.....Cu/Ni/Sn
 Rated Current...Ind. drop 50 % typ at I sat
 Temperature Rise
40 °C max at rated I rms
 Packaging.....900 pcs. per reel

Recommended Layout

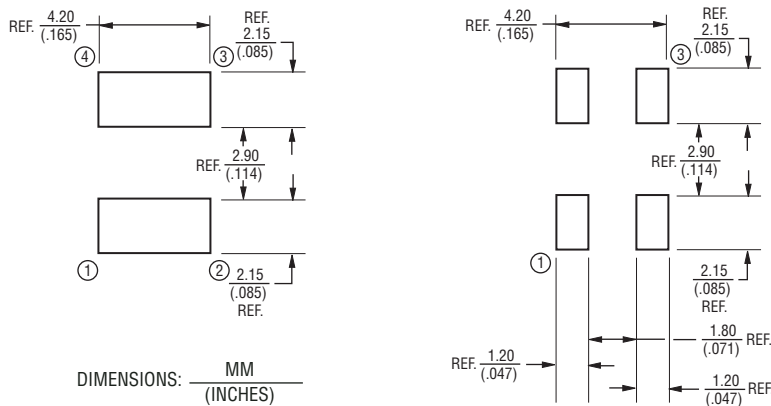

Product Dimensions

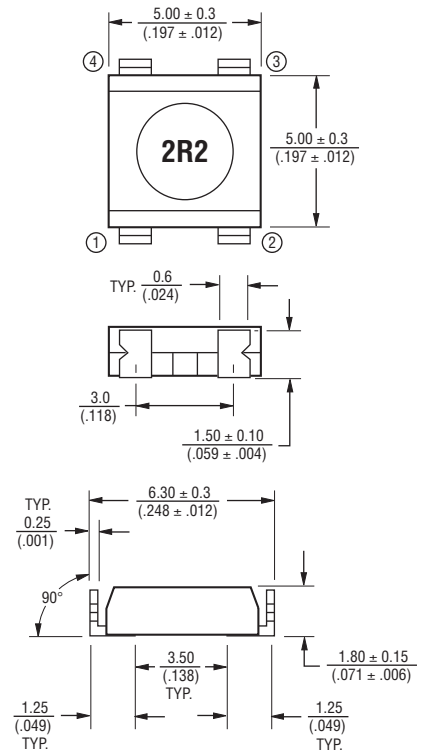

Electrical Schematic

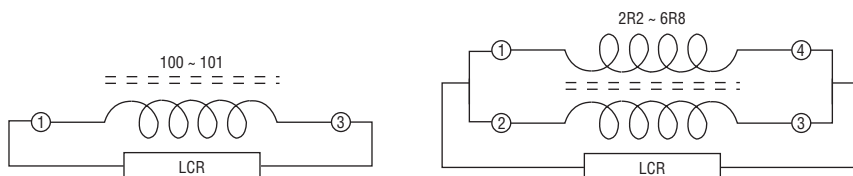

*RoHS Directive 2002/95/EC Jan. 27, 2003 including annex and RoHS Recast 2011/65/EU June 8, 2011.
 Specifications are subject to change without notice.
 The device characteristics and parameters in this data sheet can and do vary in different applications and actual device performance may vary over time.
 Users should verify actual device performance in their specific applications.

Applications

- Input/output of DC/DC converters
- Power supplies for:
 - Portable communication equipment
 - Camcorders
 - LCD TVs
 - Car radios

SRR0618 Series - Shielded Power Inductors

BOURNS®

Packaging Specifications

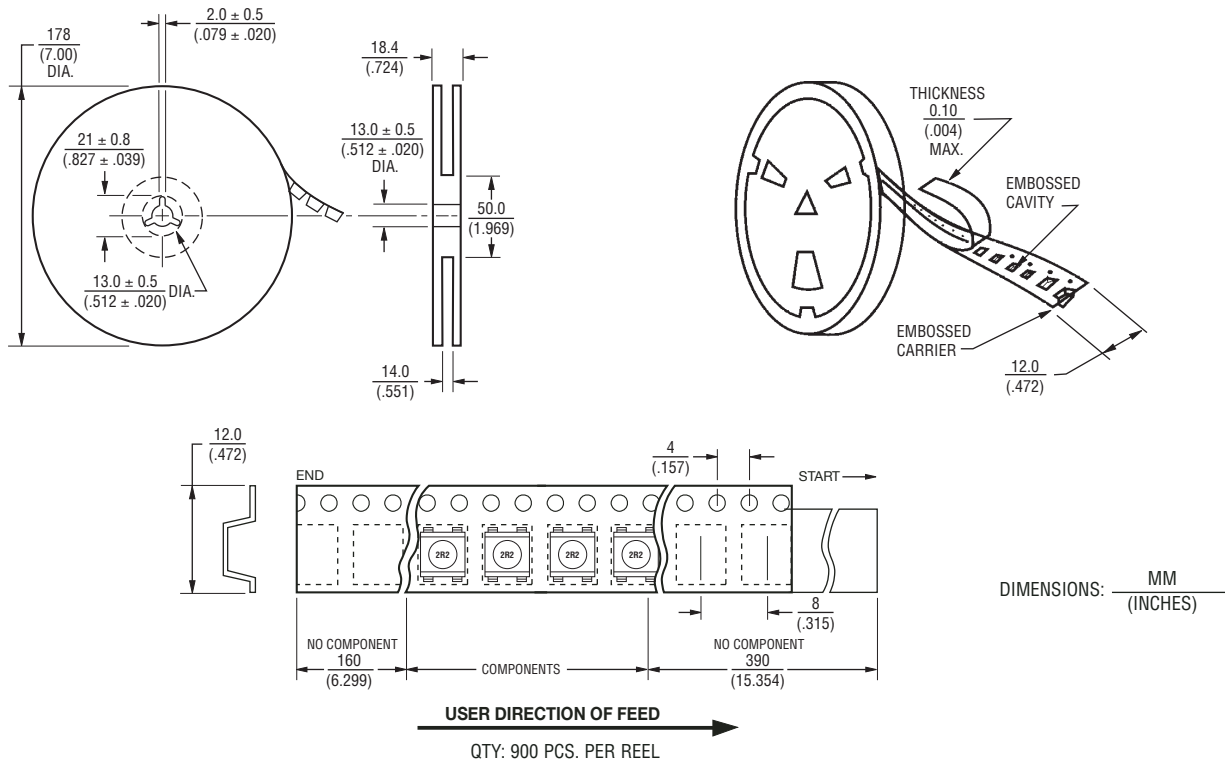

REV. 04/16

Specifications are subject to change without notice.

The device characteristics and parameters in this data sheet can and do vary in different applications and actual device performance may vary over time.

Users should verify actual device performance in their specific applications.

Looking for pricing, stock, or lifecycle information?

Click below to explore more details on WIN SOURCE:

 [View SRR0618-330ML on WIN SOURCE](#)

 [Bourns Inc. Information](#)

Optimize Your Supply Chain with WIN SOURCE Solutions

-  Global Sourcing Solution
-  Obsolete Management
-  Cost Control Management
-  Shortage Management
-  Alternative Solution
-  Excess Inventory Management