



**THE DATASHEET OF  
SW-031-145**



NOTES:

- MATERIAL #1: PPS, GLASS FILLED, 94V-0, BLACK
- MATERIAL #2: NYLON 6/6, 94V-0, BLACK
- MATERIAL #3: PPS, 94V-0, BLACK
- SW-032-135 ACCEPTABLE TORQUE RANGE: 300-400 mN-m.
- SW-040-140 ACCEPTABLE TORQUE RANGE: 300-400 mN-m.

REVISIONS			
REV.	DESCRIPTION	DATE	APPROVED
T	ECO-1062, ADD TORQUE RANGE NOTE	7/13/20	A.V.
U	ECO-1112, ADD TORQUE RANGE NOTE	12/13/21	A.V.
V	ECO-1237, UPDATE MAT'L CALL OUT	3/4/2024	A.V.
W	ECO-1253, UPDATE TOLERANCE CALL OUTS	5/14/2024	A.V.

PARTNO.	L	ØA	B	ØC	ØD	SCREWSIZE	FIG.	MATERIAL
SW-032-135	.032 (0.8mm)	.215 (5.5mm)	.040 (1.0mm)	.130 (3.3mm)	.116 (3.0mm)	4	1	1
SW-040-140	.040 (1.0mm)	.245 (6.2mm)	.040 (1.0mm)	.140 (3.6mm)	.119 (3.0mm)	4	2	1
SW-125-140	.125 (3.2mm)	.280 (7.1mm)	.042 (1.1mm)	.140 (3.6mm)	.112 (2.8mm)	4	1	1
SW-031-145	.031 (0.8mm)	.280 (7.1mm)	.047 (1.2mm)	.145 (3.7mm)	.118 (3.0mm)	4	1	1
SW-093-145	.093 (2.4mm)	.235 (6.0mm)	.047 (1.2mm)	.140 (3.6mm)	.115 (2.9mm)	4	1	2
SW-187-145	.187 (4.8mm)	.235 (6.0mm)	.047 (1.2mm)	.140 (3.6mm)	.115 (2.9mm)	4	1	2
SW-125-150	.125 (3.2mm)	.280 (7.1mm)	.042 (1.1mm)	.150 (3.8mm)	.112 (2.8mm)	4	1	3
SW-185-150	.185 (4.7mm)	.280 (7.1mm)	.042 (1.1mm)	.150 (3.8mm)	.122 (3.1mm)	4	1	1
SW-031-177	.031 (0.8mm)	.312 (7.9mm)	.047 (1.2mm)	.177 (4.5mm)	.144 (3.7mm)	6	1	1
SW-031-190	.031 (0.8mm)	.312 (7.9mm)	.047 (1.2mm)	.190 (4.8mm)	.146 (3.7mm)	6	1	3

DIMENSION	TOLERANCE 0.0 TO 0.193 (0.0mm TO 4.9mm)	TOLERANCE 0.197 TO 0.394 (5.0mm TO 10.0mm)
ØA	±0.008(±0.2mm)	±0.012(±0.3mm)
B	±0.008(±0.2mm)	
L	±0.008(±0.2mm)	



ISO VIEW

**CUSTOMER USE DRAWING**

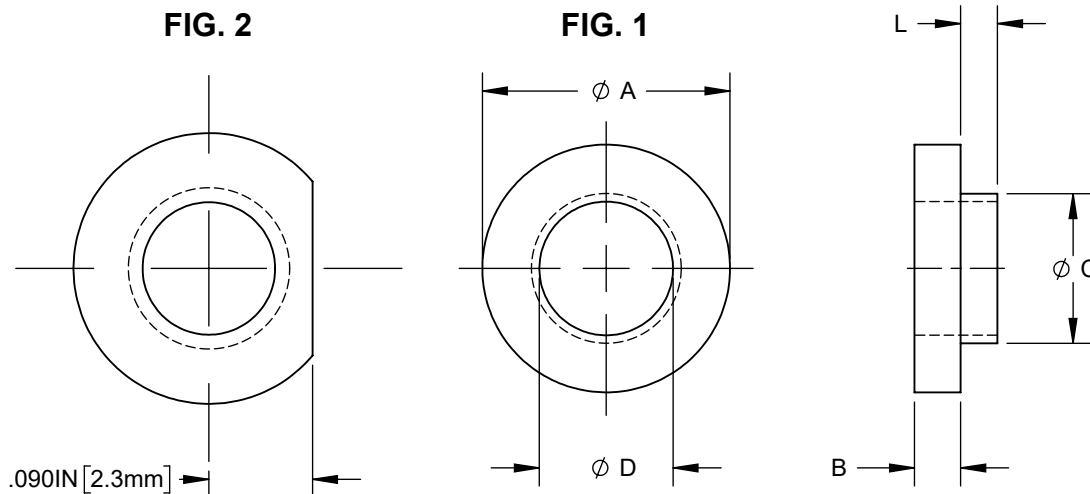

STANDARD TOLERANCE (UNLESS OTHERWISE SPECIFIED)		 4 THOMAS, IRVINE, CA. 92618 TEL: (949) 951-8808 FAX: (949) 951-3974			
DECIMALS	ANGULAR				
.X ±.1	X° ±1°	TITLE: HIGH TEMPERATURE SHOULDER WASHER			
.XX ±.01					
.XXX ±.005		DESIGNED: D. GREEN	DATE: 01/17/2003	DRAWING NO: SW-XXX-XXX-W	REVISION: W
		REVISD: D. ASHBY	DATE: 05/14/2024	SHEET SIZE A	CAGE CODE: 32559
		CHECKED: A. VALDEZ	DATE: 05/14/2024	SCALE: 6:1	SHEET # 1 OF 1
CAD GENERATED DOCUMENT, DO NOT MEASURE DRAWING					

## Looking for pricing, stock, or lifecycle information?

Click below to explore more details on WIN SOURCE:

 [View SW-031-145 on WIN SOURCE](#)

 [Bivar Inc. Information](#)

## Optimize Your Supply Chain with WIN SOURCE Solutions

-  Global Sourcing Solution
-  Obsolete Management
-  Cost Control Management
-  Shortage Management
-  Alternative Solution
-  Excess Inventory Management