



THE DATASHEET OF SF2287E



- 895 MHz Low-loss SAW Filter
- Surface Mount 3.0 x 3.0 mm Package
- Complies with Directive 2002/95/EC (RoHS)
- Moisture Sensitivity Level: 1

Absolute Maximum Ratings

Rating	Value	Units
Input Power Level	15	dBm
DC Voltage on any Non-ground Terminal	5	V
Operable Temperature Range	-45 to +125	°C
Specification Temperature Range	-40 to +85	°C
Storage Temperature Range in Tape and Reel	-40 to +85	°C
Solder Reflow Temperature, 10 seconds, 5 cycles maximum	260	°C

SF2287E

**895 MHz
SAW Filter**

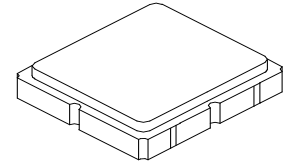

SM3030-6

Electrical Characteristics

Characteristic	Sym	Notes	Min	Typ	Max	Units
Center Frequency	f_C			895		MHz
Minimum Insertion Loss, 894 to 896 MHz	IL_{MIN}			2.6	3.2	dB
Amplitude Ripple, 894 to 896 MHz				0.3	1.2	dB _{p-p}
Input/Output Return Loss, 894 to 896 MHz			9	12		dB
Attenuation, Referenced to 0 dB						
10 to 851 MHz			40	56		dB
1030 to 1100 MHz			40	54		
1100 to 2600 MHz			25	33		
Source Impedance	Z_S			50		Ω
Load Impedance	Z_L			50		
Temperature Coefficient of Frequency	TCf			-36		ppm/°C
Case Style	SM3030-6 3.0 x 3.0 mm Nominal Footprint					
Lid Symbolization, Y=year, WW=week, S=shift, dot=pin 1 indicator	A34, <u>YWWS</u>					
Standard Reel Quantity	Reel Size 7 Inch					500 Pieces/Reel
	Reel Size 13 Inch					3000 Pieces/Reel



CAUTION: Electrostatic Sensitive Device. Observe precautions for handling.

NOTES:

1. The design, manufacturing process, and specifications of this device are subject to change.
2. US or International patents may apply.
3. RoHS compliant from the first date of manufacture.

Frequency Characteristics

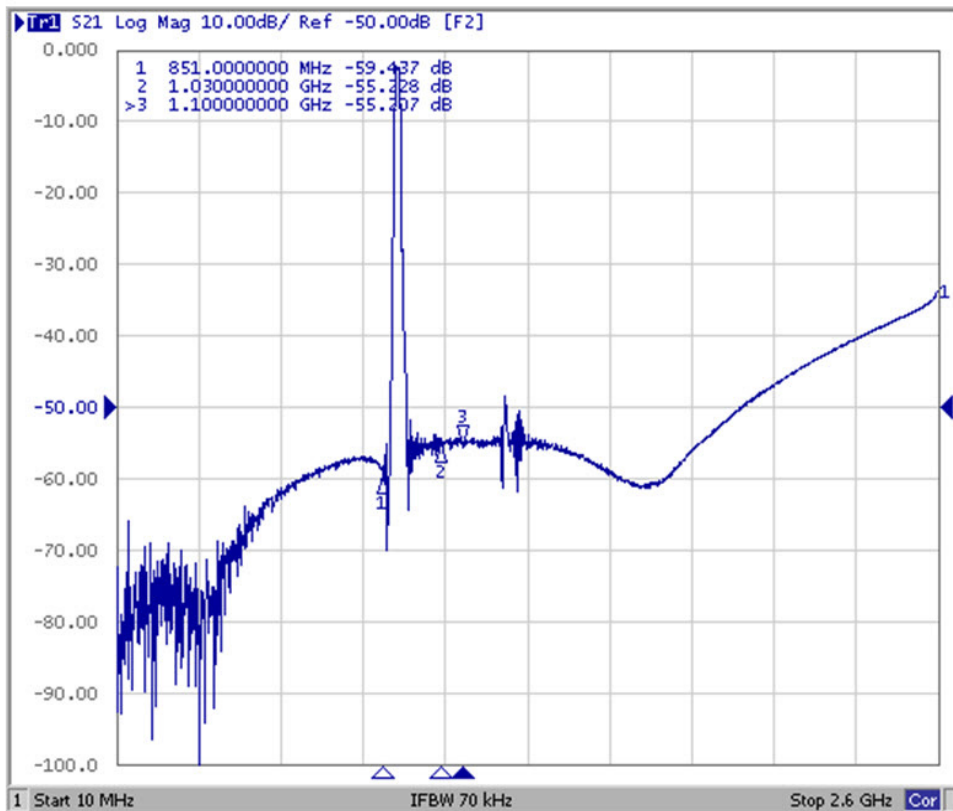
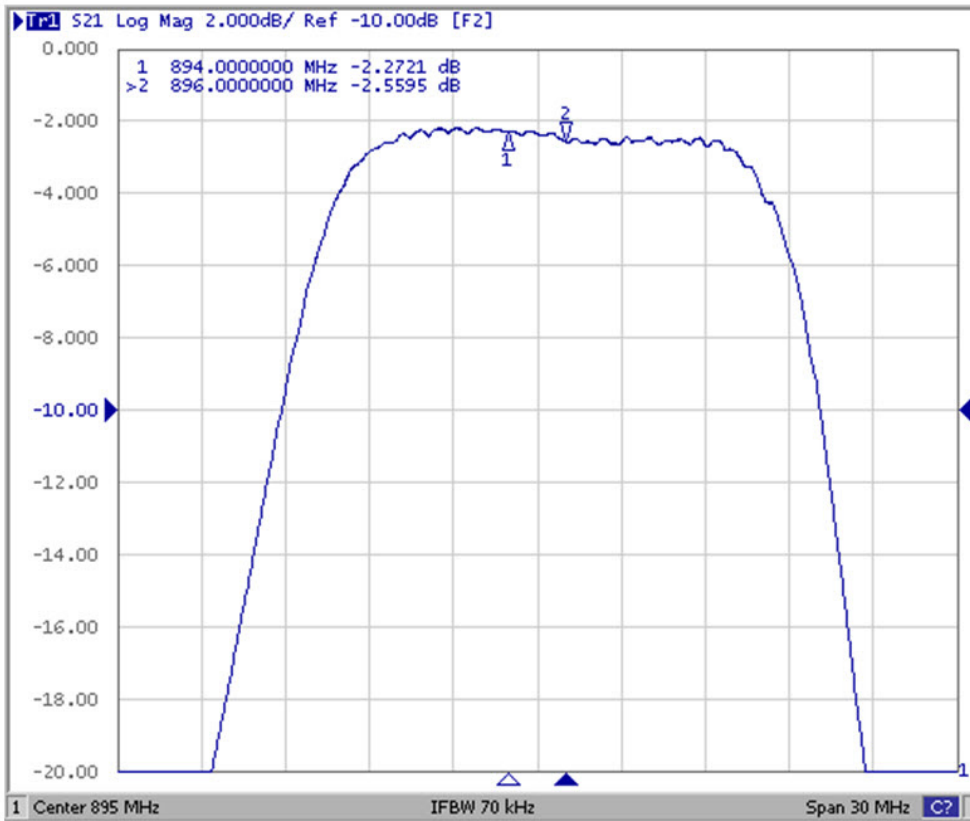

Reflection Functions

S11

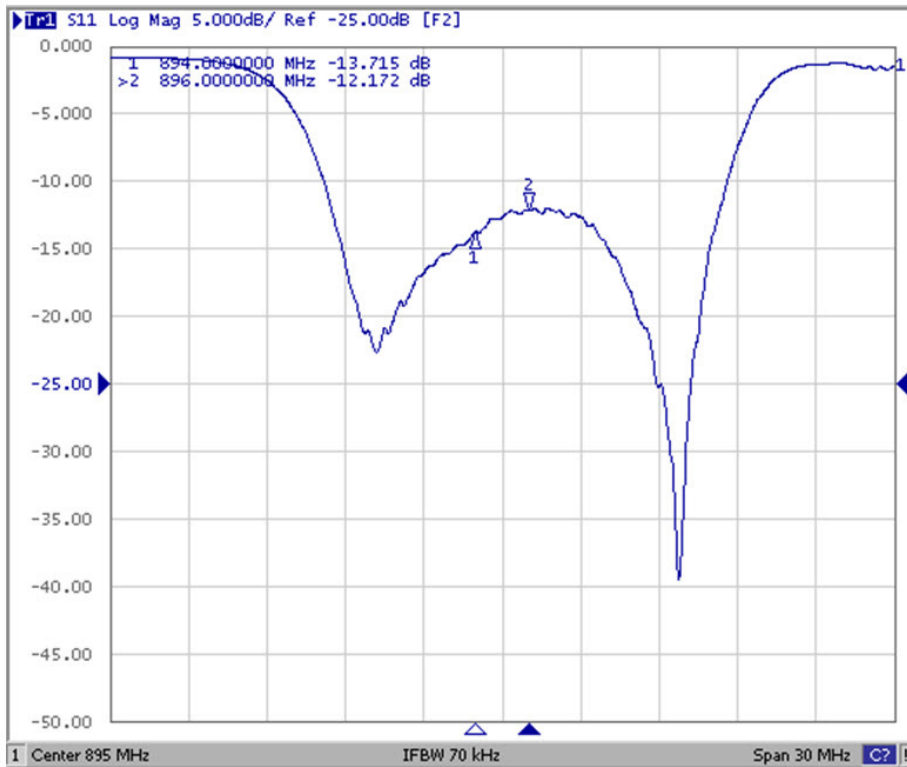

S22

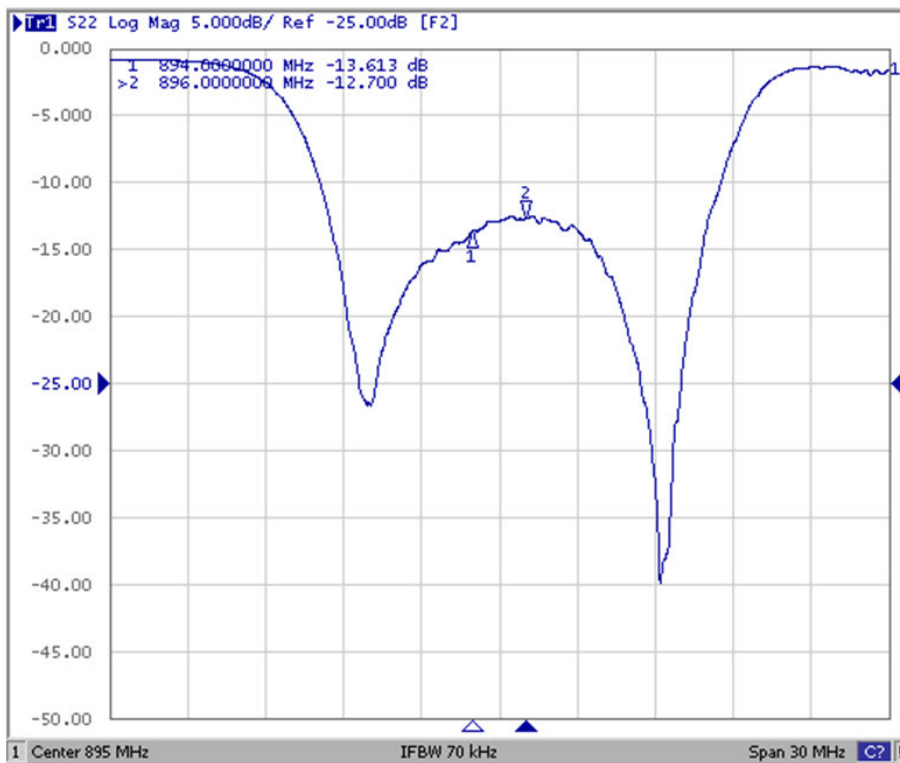

SM3030-6 Case

6-Terminal Ceramic Surface-Mount Case 3.0 X 3.0 mm Nominal Footprint

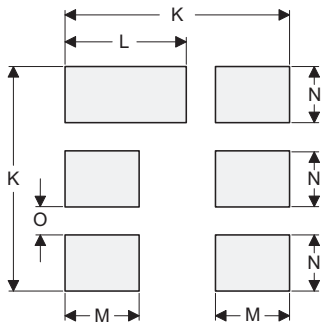
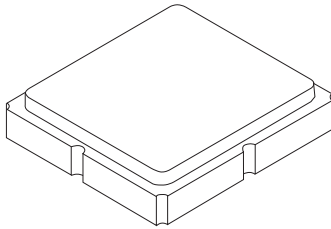

PCB Land Pattern
Top View

Case and PCB Footprint Dimensions

Dimension	mm			Inches		
	Min	Nom	Max	Min	Nom	Max
A	-	3.00	-	-	0.118	-
B	-	3.00	-	-	0.118	-
C	-	-	1.40	-	-	0.055
D	-	0.90	-	-	0.035	-
E	-	2.80	-	-	0.110	-
F	-	1.60	-	-	0.063	-
G	-	0.85	-	-	0.033	-
H	-	1.50	-	-	0.059	-
I	-	0.60	-	-	0.024	-
J	-	1.30	-	-	0.051	-
K	-	3.20	-	-	0.126	-
L	-	1.70	-	-	0.067	-
M	-	1.05	-	-	0.041	-
N	-	0.81	-	-	0.032	-
O	-	0.38	-	-	0.015	-

Case Materials

Materials	
Solder Pad Plating	0.3 to 1.0 μm Gold over 1.27 to 8.89 μm Nickel
Lid Plating	2.0 to 3.0 μm Nickel
Body	Al_2O_3 Ceramic

Electrical Connections

Connection	Terminals
Input	2
Output	5
Ground	All Others

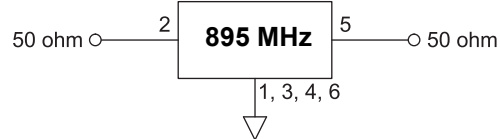

TOP VIEW

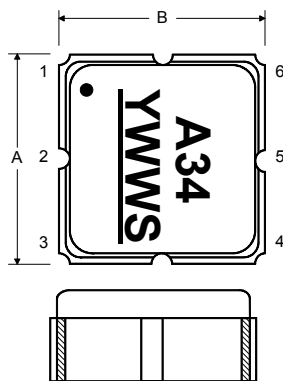

BOTTOM VIEW

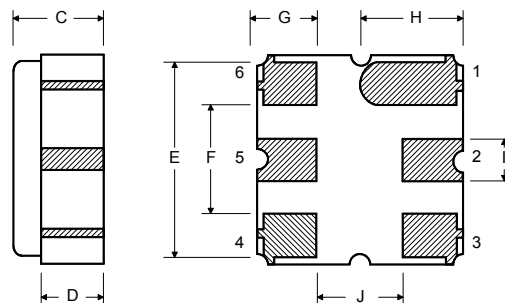

Tape and Reel Specifications

Tape and Reel Standard per ANSI/EIA-481

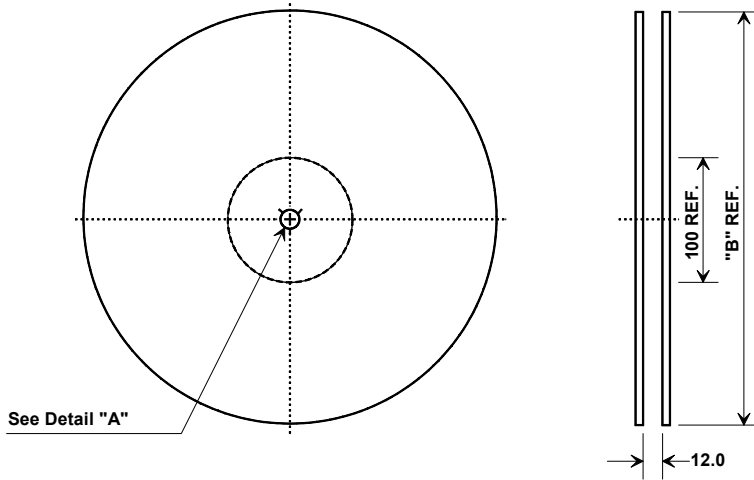

"B"		Quantity Per Reel
Inches	millimeters	
7	178	500
13	330	3000

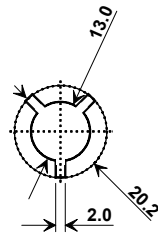

COMPONENT ORIENTATION and DIMENSIONS

Carrier Tape Dimensions	
Ao	3.35 mm
Bo	3.35 mm
Ko	1.40 mm
Pitch	8.0 mm
W	12.0 mm

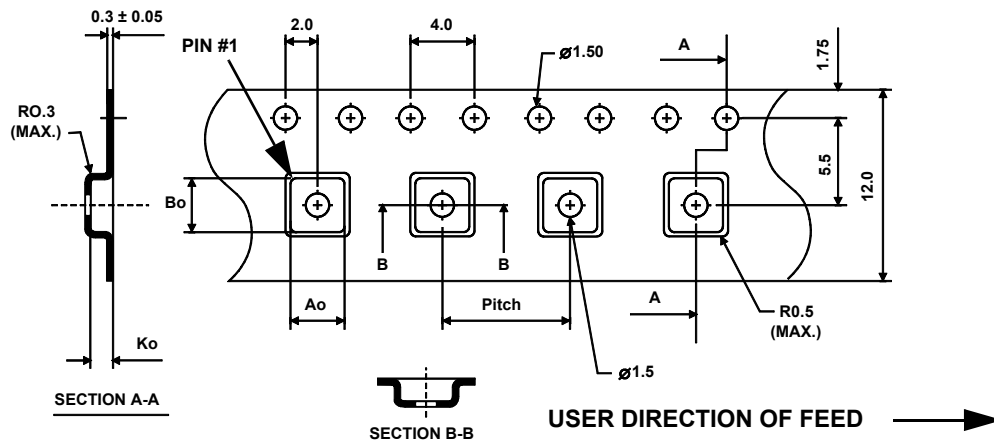

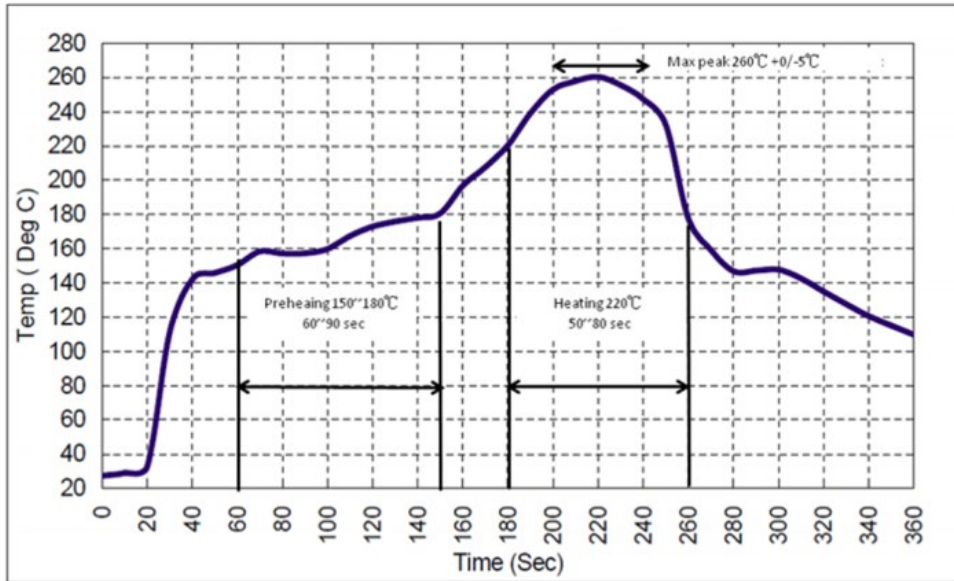

Recommended Reflow Profile

1. Preheating shall be fixed at 150~180°C for 60~90 seconds.
2. Ascending time to preheating temperature 150°C shall be 30 seconds min.
3. Heating shall be fixed at 220°C for 50~80 seconds and at 260°C +0/-5°C peak (10 seconds).
4. Time: 5 times maximum.



Looking for pricing, stock, or lifecycle information?

Click below to explore more details on WIN SOURCE:

-  [View SF2287E on WIN SOURCE](#)
-  [RF Monolithics, Inc Information](#)

Optimize Your Supply Chain with WIN SOURCE Solutions

-  Global Sourcing Solution
-  Obsolete Management
-  Cost Control Management
-  Shortage Management
-  Alternative Solution
-  Excess Inventory Management