

- **RF Filter for Mobile Communication Applications**
- **Low Insertion Loss**
- **3.0 x 3.0 x 1.3 mm Surface-Mount Case**
- **No Matching Circuit Required**
- **Complies with Directive 2002/95/EC (RoHS)**
- **Moisture Sensitivity Level: 1**

Absolute Maximum Ratings

Rating	Value	Units
Maximum Incident Power in Passband	+10	dBm
Maximum DC Voltage Between any 2 Terminals	0	VDC
Storage Temperature Range	-40 to +85	°C
Maximum Soldering Profile	265 °C for 10 s	

SF1182B

**836.5 MHz
SAW Filter**

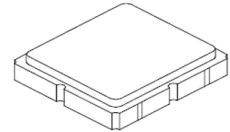

SM3030-6

Characteristic	Sym	Notes	Min	Typ	Max	Units
Nominal Operating Frequency	f_C			836.5		MHz
Insertion Loss, 824-849 MHz	IL			2.1	3.0	dB
Amplitude Ripple, p-p, 824-849 MHz				1.2	2.0	
Attenuation Referenced to IL:						dB
DC to 800 MHz			23	26		
869 to 894 MHz			29	32		
978 to 1006 MHz			25	28		
1050 to 2500 MHz			15	18		
VSWR, 824-849 MHz				1.8:1	2.3:1	
Source impedance	Z_S			50		Ω
Load impedance	Z_L			50		Ω
Operating Temperature	T_A		-30		+85	°C
Single Ended Input / Output, Impedance match	No matching network required for operation at 50 ohms					
Case Style	SM3030-6 3 x 3 mm Nominal Footprint					
Lid Symbolization (Y =year, WW=week, S = Shift)	448 <u>YWWS</u>					



CAUTION: Electrostatic Sensitive Device. Observe precautions for handling.

NOTES:

1. The design, manufacturing process, and specifications of this device are subject to change.
2. US or International patents may apply.
3. RoHS compliant from the first date of manufacture.

Electrical Connections

Connection	Terminals
Input	2
Output	5
Ground	All others

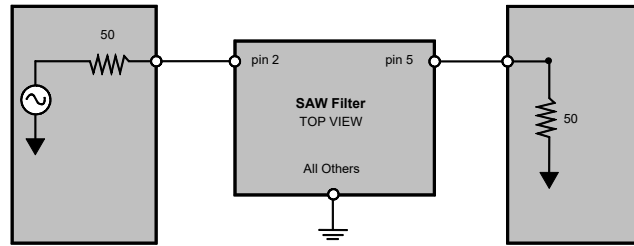

Filter Response Plots

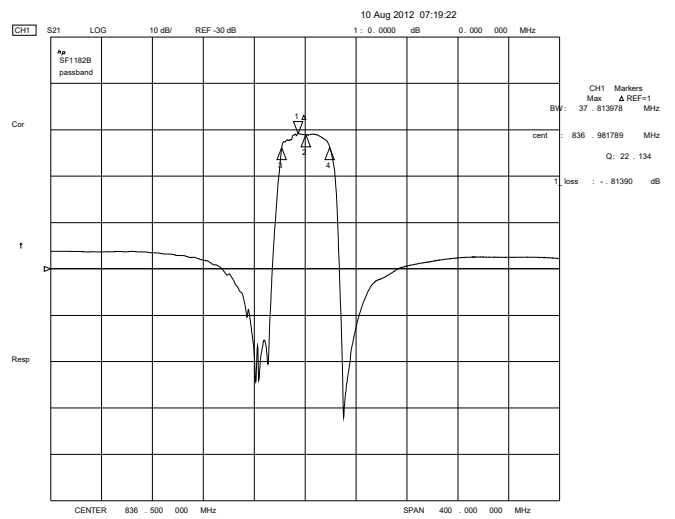
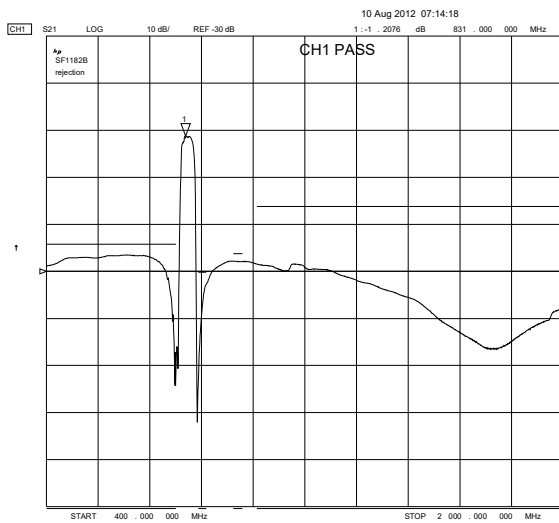

SM3030-6 Case

6-Terminal Ceramic Surface-Mount Case 3.0 X 3.0 mm Nominal Footprint

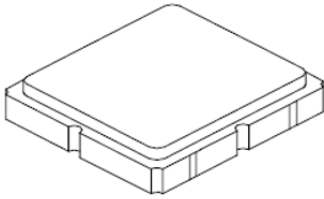

Case Dimensions

Dimension	mm			Inches		
	Min	Nom	Max	Min	Nom	Max
A		3.0			0.118	
B		3.0			0.118	
C		1.3			0.051	
D		0.9			0.035	
E		2.54			0.100	
F		1.6			0.063	
G		0.85			0.033	
H		1.5			0.059	
I		0.6			0.024	
J		1.3			0.051	

Electrical Connections

Connection		Terminals
Port 1	Single Ended Input	2
Port 2	Single Ended Output	5
	Ground	All others
Single-ending Operation Only		
Dot indicates Pin 1		

TOP VIEW

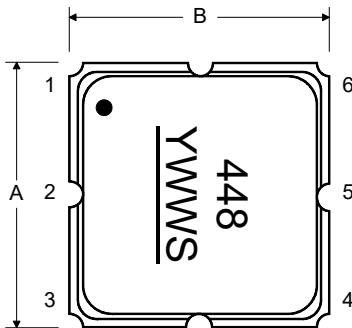

BOTTOM VIEW

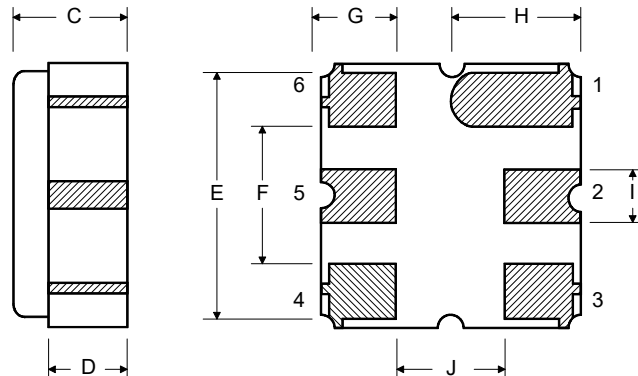

Tape and Reel Specifications

Tape and Reel Standard per ANSI/EIA-481

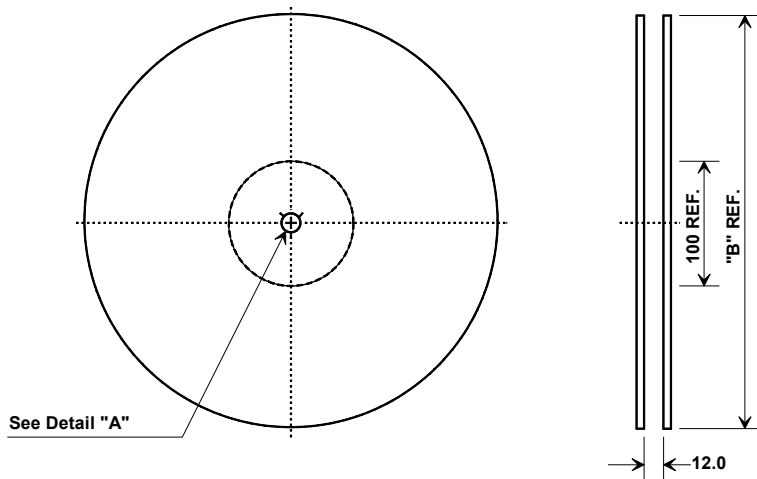

"B"		Quantity Per Reel
Inches	millimeters	
7	178	500
13	330	3000

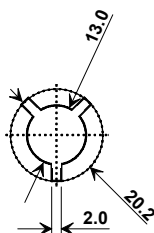

COMPONENT ORIENTATION and DIMENSIONS

Carrier Tape Dimensions	
Ao	3.35 mm
Bo	3.35 mm
Ko	1.4 mm
Pitch	8.0 mm
W	12.0 mm

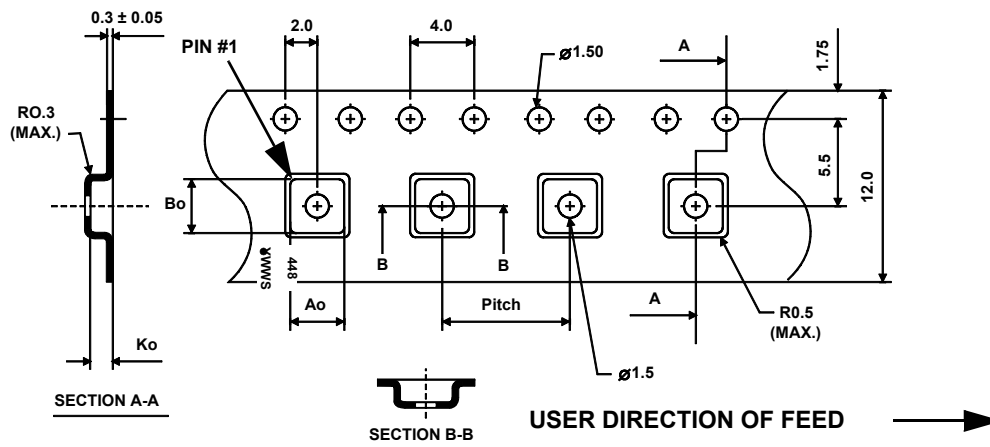

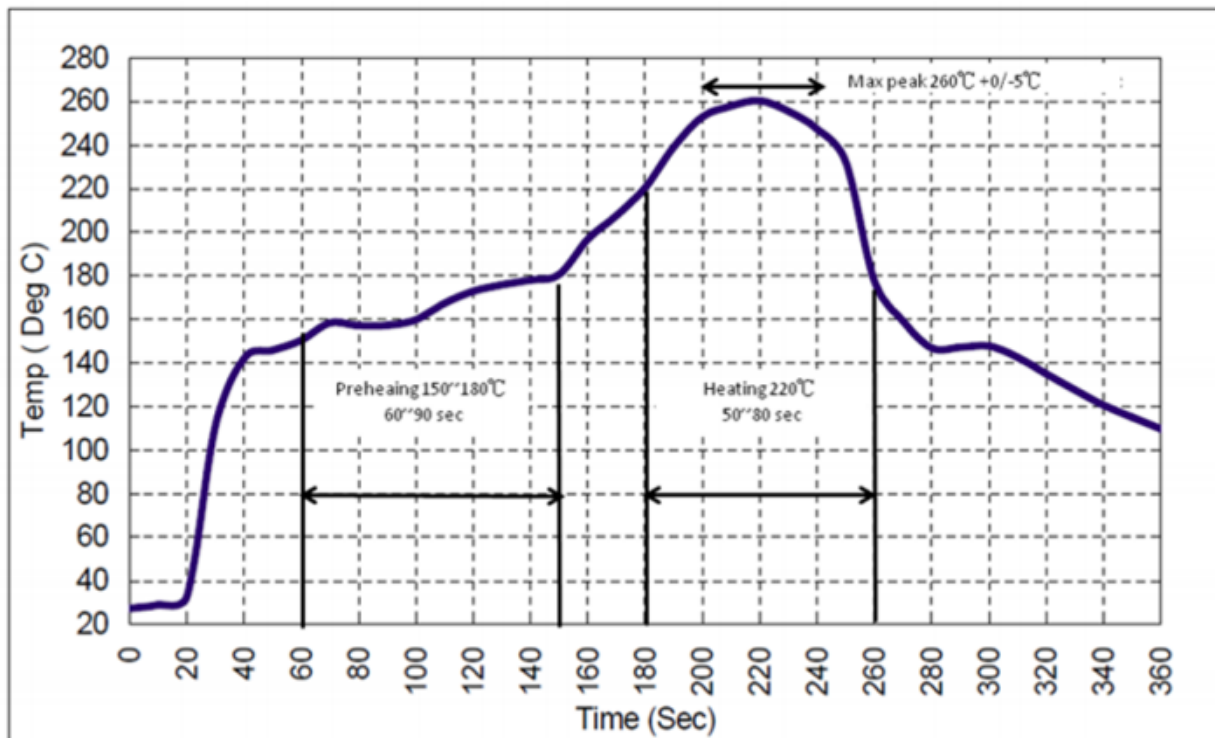

Recommended Reflow Profile

1. Preheating shall be fixed at 150~180°C for 60~90 seconds.
2. Ascending time to preheating temperature 150°C shall be 30 seconds min.
3. Heating shall be fixed at 220°C for 50~80 seconds and at 260°C+0/-5°C peak (10 seconds).
4. Time: 5 times maximum.



Looking for pricing, stock, or lifecycle information?

Click below to explore more details on WIN SOURCE:

-  [View SF1182B on WIN SOURCE](#)
-  [RF Monolithics, Inc Information](#)

Optimize Your Supply Chain with WIN SOURCE Solutions

-  Global Sourcing Solution
-  Obsolete Management
-  Cost Control Management
-  Shortage Management
-  Alternative Solution
-  Excess Inventory Management