



**THE DATASHEET OF  
SF1219K**



- RF SAW Filter with Single-ended input and Balanced Output
- 1.4 x 1.1 x 0.6 mm Surface-Mount Case
- $Z_S = 50 \text{ ohm}$ ,  $Z_L = 100 \text{ ohm}$
- Complies with Directive 2002/95/EC (RoHS)
- Moisture Sensitivity Level: 3
- AEC-Q200 Qualified

#### Absolute Maximum Ratings

Rating	Value	Units
Maximum Input Power	+15	dBm
Maximum DC Voltage Between any Two Terminals	3	V
Operating Temperature Range	-40 to +85	°C
Storage Temperature Range in Tape and Reel	-40 to +85	°C
Maximum Soldering Profile	265 °C for 10 s	

**SF1219K**

**2338.75 MHz  
SAW Filter**

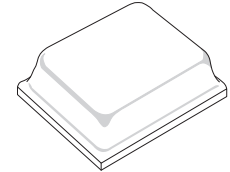

**SM1411-5H**

#### Electrical Characteristics

Characteristic	Sym	Notes	Min	Typ	Max	Units
Center Frequency	$f_C$		2338.75			MHz
Maximum Insertion Loss, 2332.5 to 2345.0 MHz	$IL_{MAX}$			2.6	3.2	dB
Amplitude Ripple, 2332.5 to 2345.0 MHz				0.2	1.0	dB <sub>P-P</sub>
Group Delay Ripple, 2332.5 to 2345.0 MHz				6.5		ns <sub>P-P</sub>
Group Delay, 2338.75 MHz				12		ns
Return Loss, 2332.5 to 2345.0 MHz			6.5	9.6		dB
Source Impedance, Single Ended				50		$\Omega$
Load Impedance, Balanced				100		$\Omega$
Rejection:						
DC to 2224 MHz			35	41		dB
2453 to 2600 MHz			35	40		
2600 to 3000 MHz			40	44		
3000 to 6000 MHz			35	44		

Case Style	1.4 x 1.1 x 0.7 mm
Lid Symbolization: 3, <u>YW</u> (Y = Year, W = Week)	

Connection	Terminal
Input	1
Output	3, 4
Ground	2, 5

 **CAUTION: Electrostatic Sensitive Device. Observe precautions for handling.**  
**NOTES:**

1. The design, manufacturing process, and specifications of this device are subject to change.
2. US or International patents may apply.
3. RoHS compliant from the first date of manufacture.

## Filter Performance without Input Matching

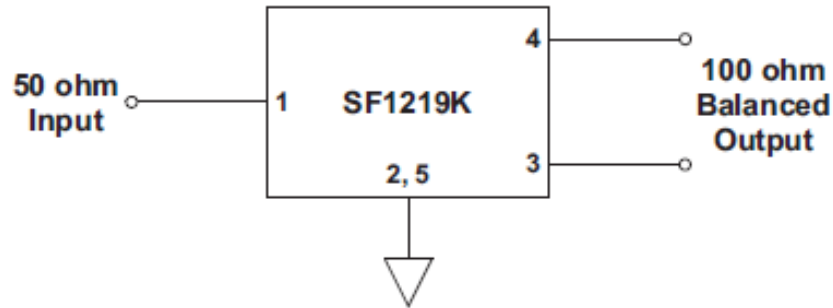

## Filter Amplitude Response, 300 kHz to 6000 MHz:

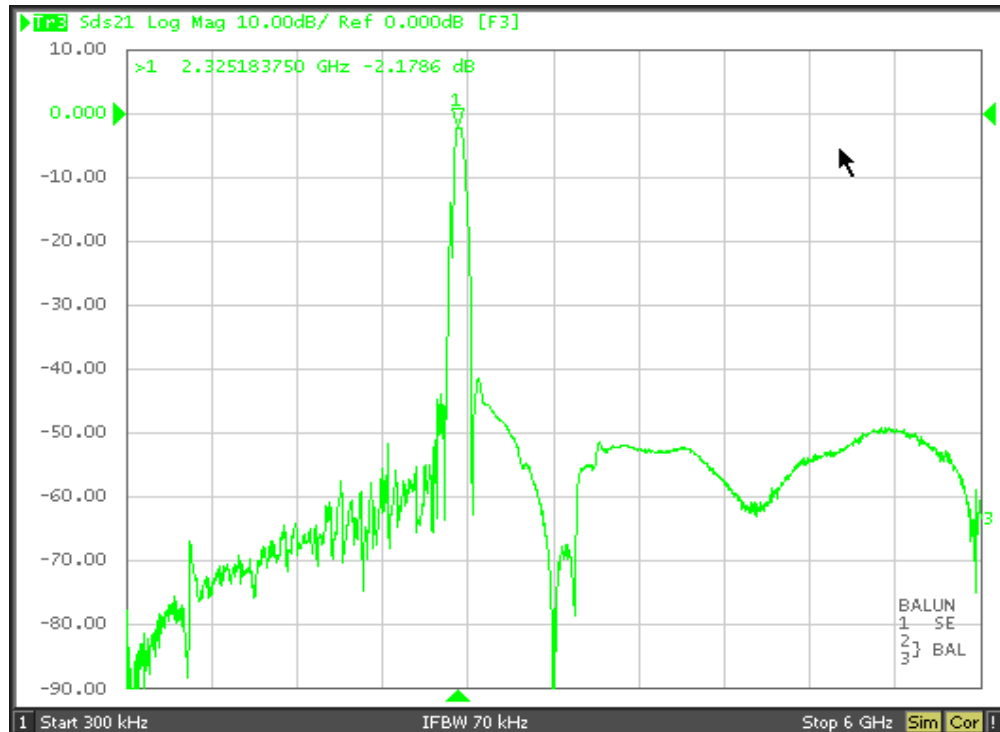

## Filter Amplitude Response, 2113 to 2563 MHz:

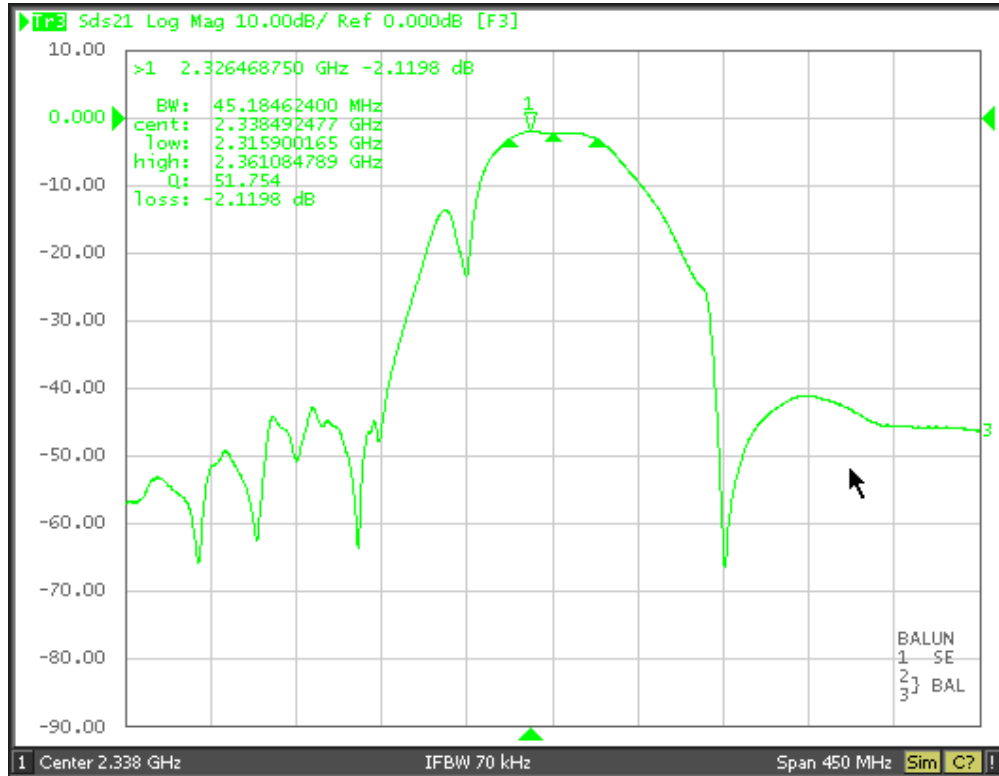

## Passband Amplitude and Return Loss:

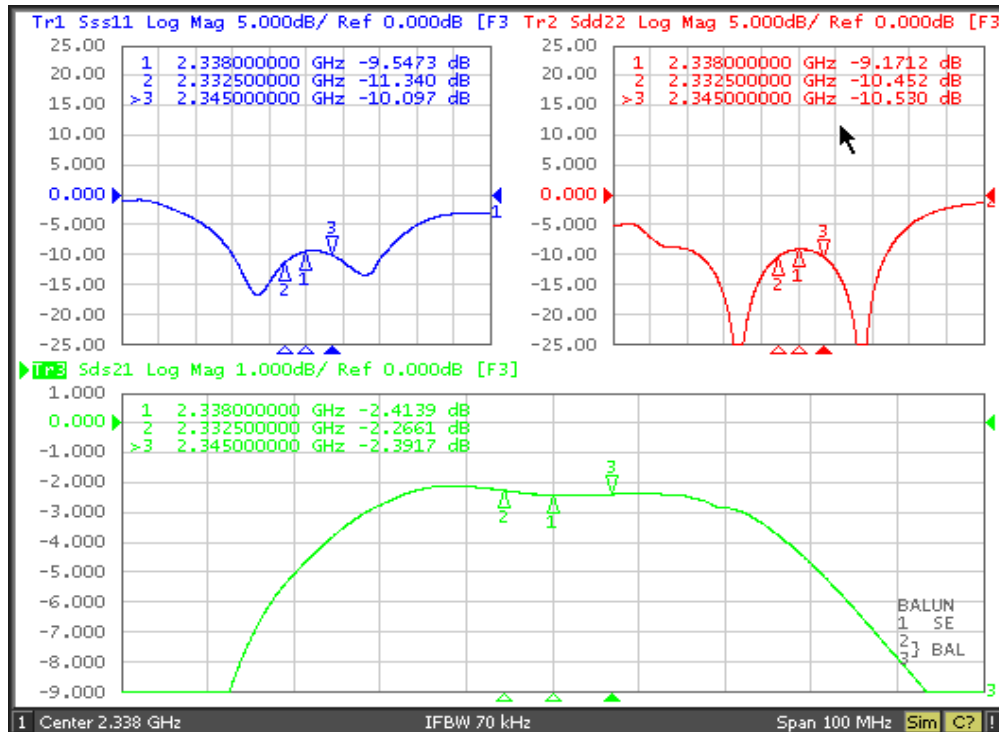

## Passband Group Delay:

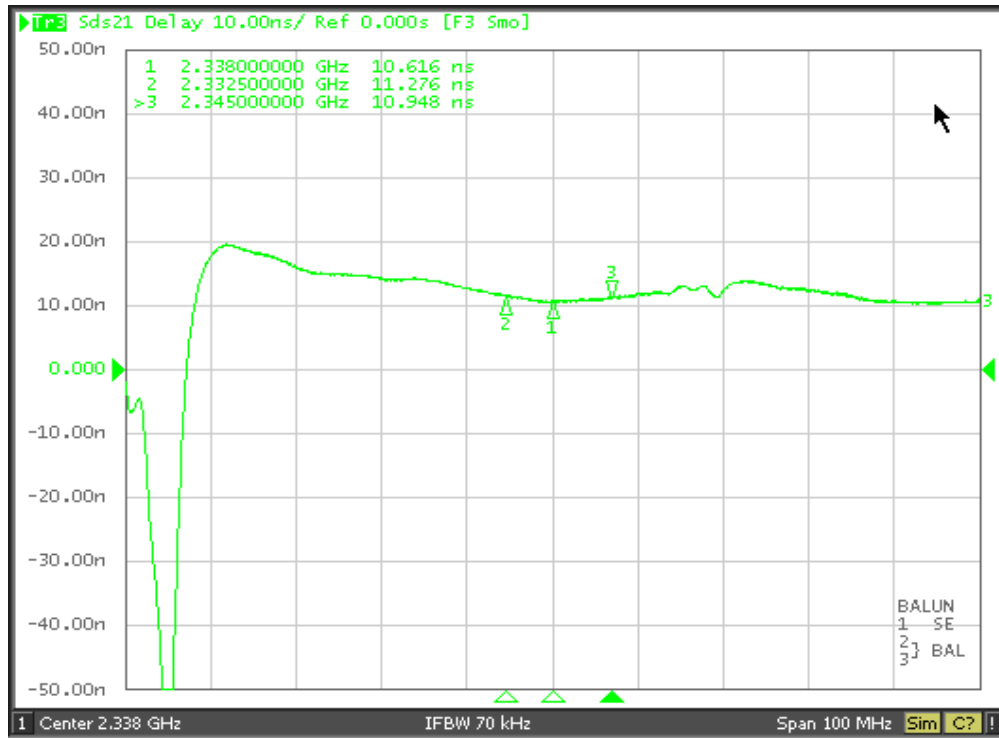

## Passband Smith Chart Plots:

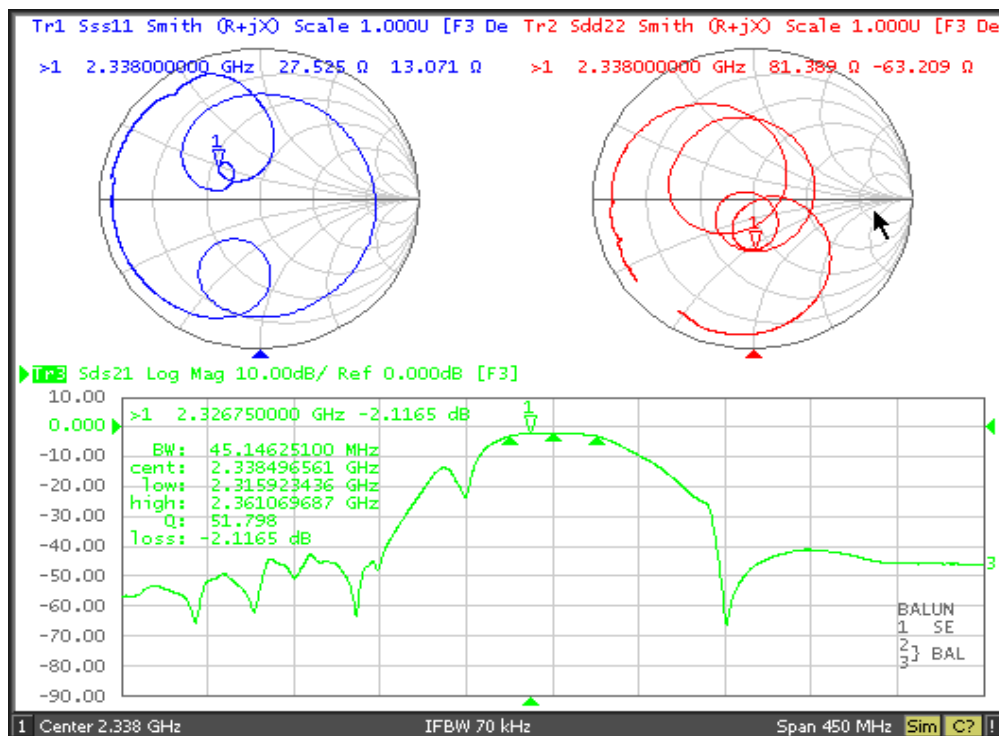

## Filter Performance with Input Matching

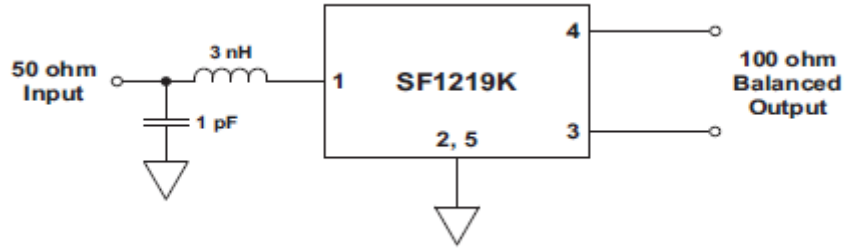

## Filter Amplitude Response, 300 kHz to 6000 MHz:

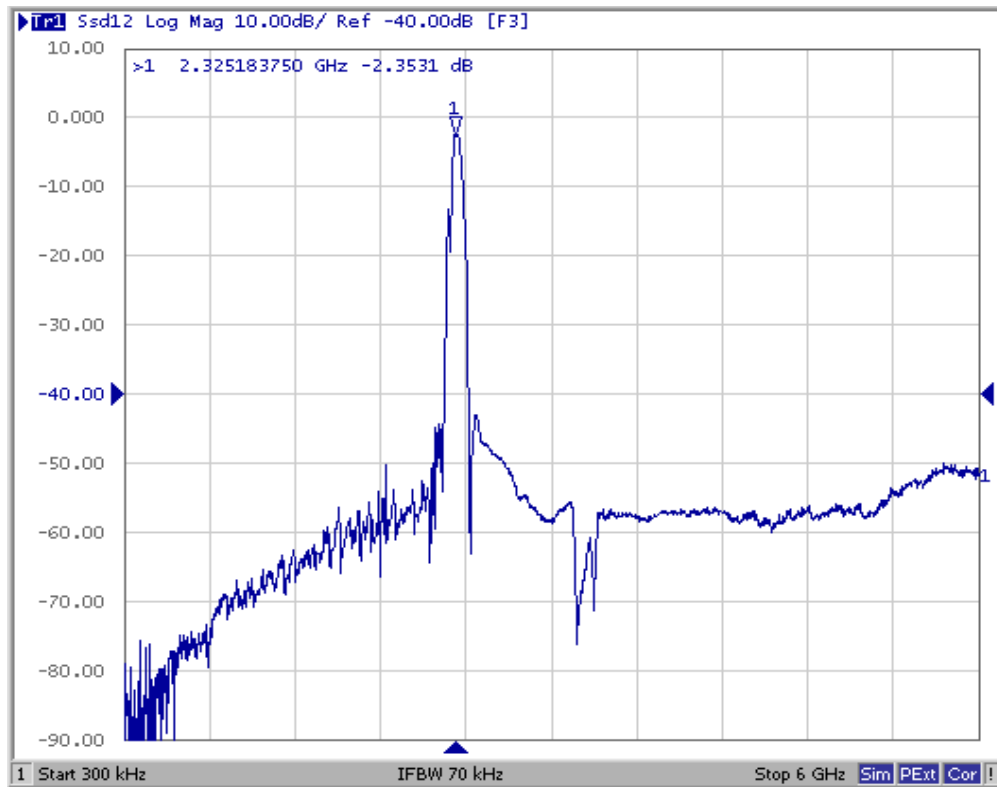

## Filter Amplitude Response, 2113 to 2563 MHz:

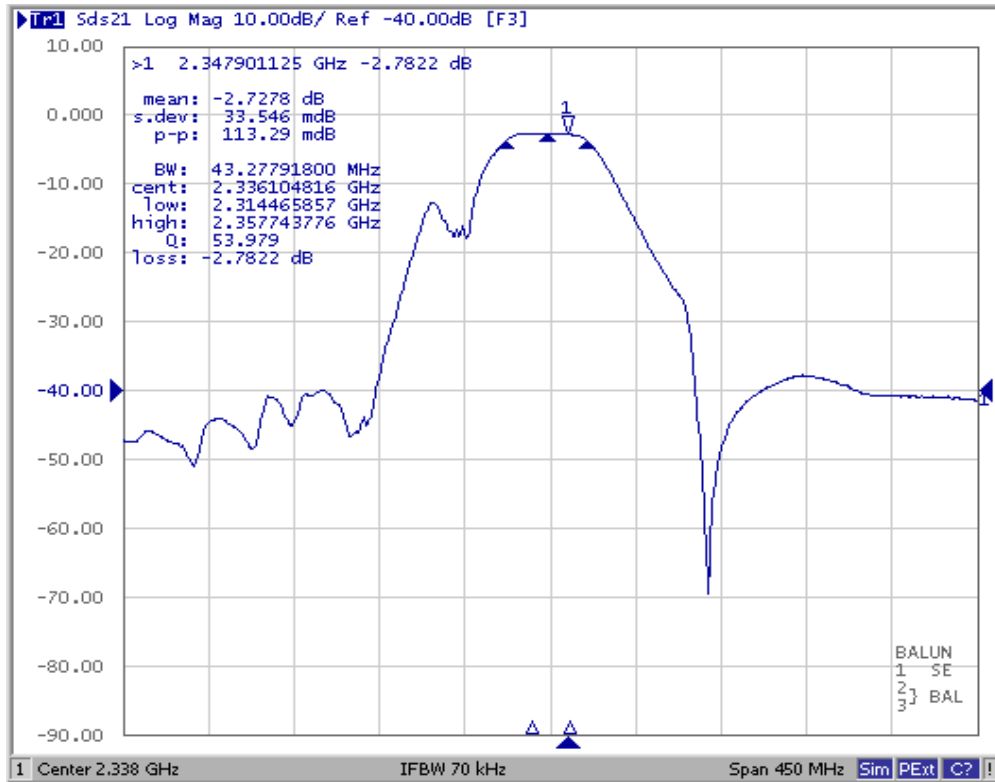

## Passband Amplitude and Group Delay Response:

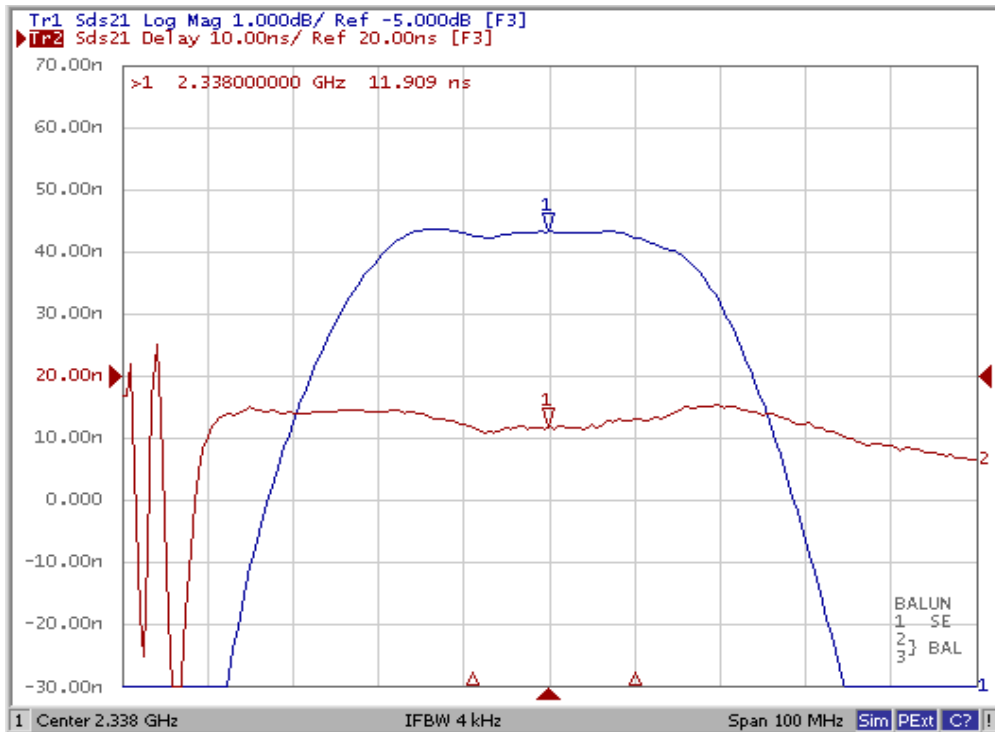

## S<sub>11</sub> Smith Chart Plot:

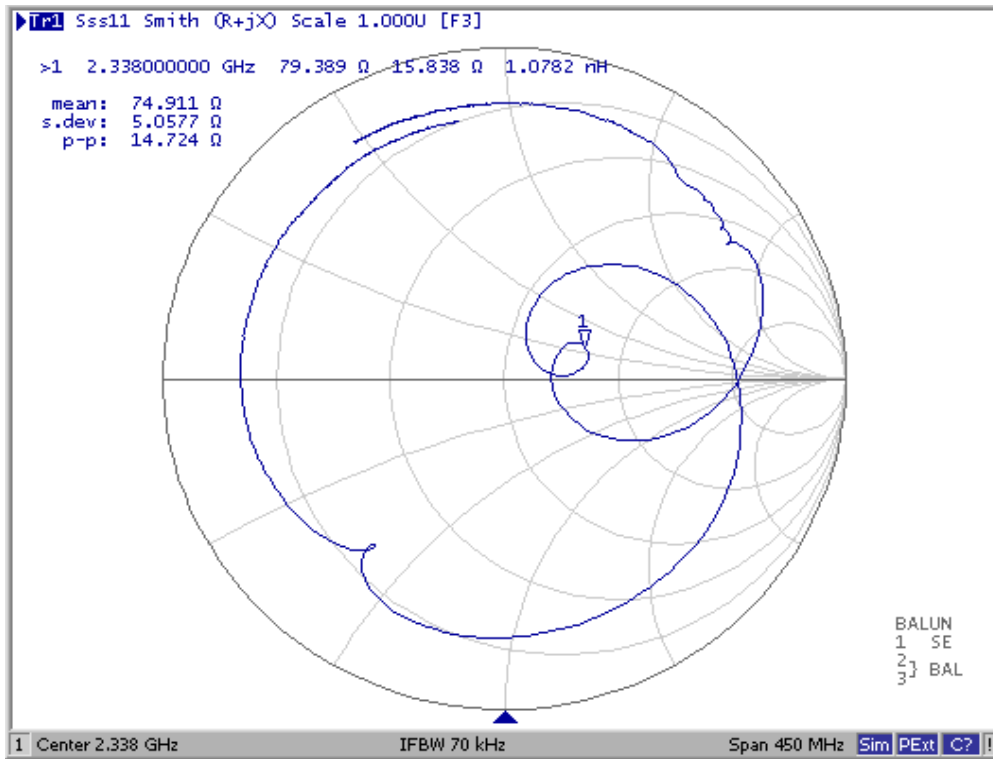

## S<sub>22</sub> Smith Chart Plot:

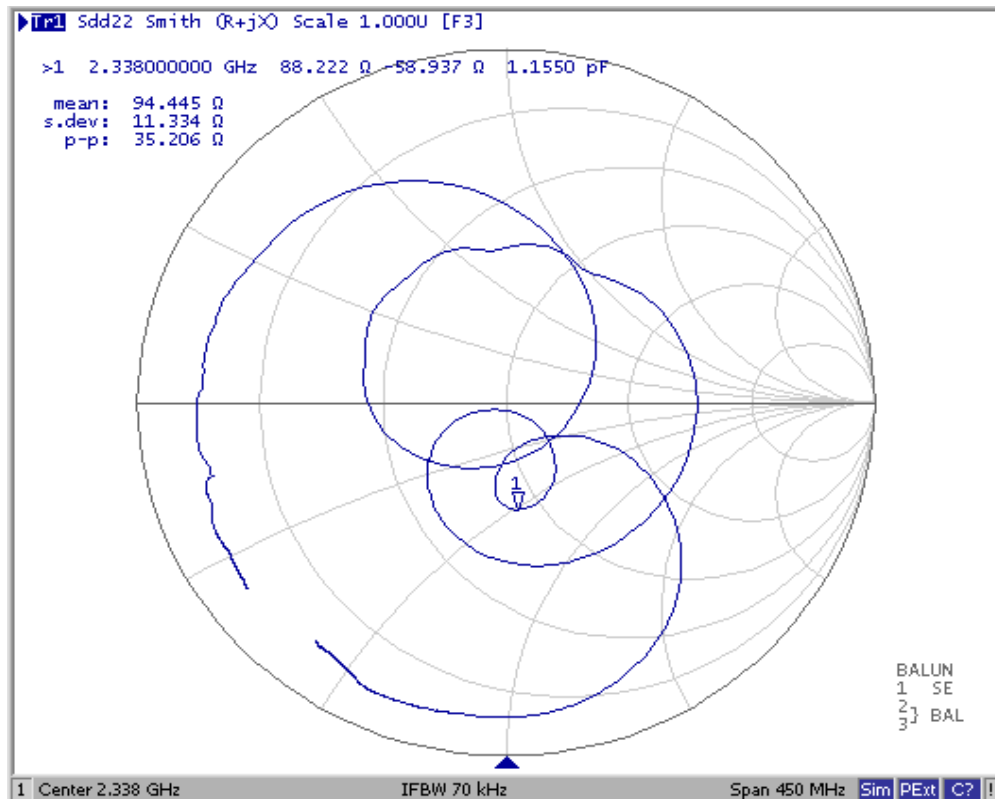

# SM1411-5H 5 Terminal 1.4 X 1.1 mm Surface-mount Case Drawing

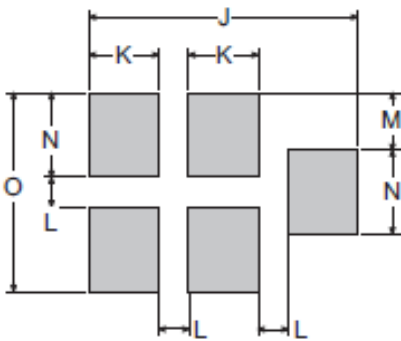
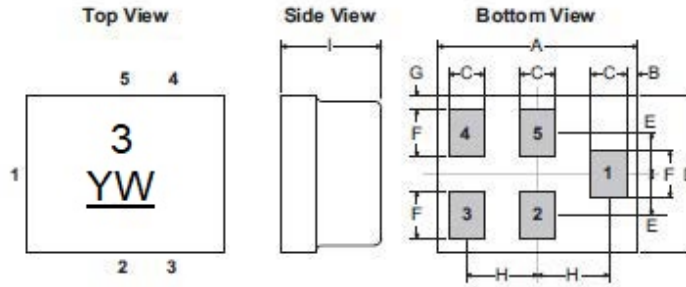

**PCB Footprint**

Dimension	mm			Inches		
	Min	Nom	Max	Min	Nom	Max
A	1.3500	1.4000	1.4500	0.0531	0.0551	0.0571
B	-	0.0750	-	-	0.0030	-
C	0.1700	0.250	0.3300	0.0067	0.0098	0.0130
D	1.0500	1.1000	1.1500	0.0413	0.0433	0.0453
E	-	0.2875	-	-	0.0113	-
F	0.2450	0.3250	0.4050	0.0096	0.0128	0.0159
G	-	0.100	-	-	0.0039	-
H	-	0.5000	-	-	0.0197	-
I	0.6000	0.6500	0.700	0.0236	0.0256	0.0276
J	-	1.3500	-	-	0.0531	-
K	-	0.3500	-	-	0.0138	-
L	-	0.1500	-	-	0.0059	-
M	-	0.2875	-	-	0.0113	-
N	-	0.4250	-	-	0.0167	-
O	-	1.0000	-	-	0.0394	-

Materials	
Solder Pad Plating	0.3 to 1.0 $\mu\text{m}$ Gold over 1.27 to 8.89 $\mu\text{m}$ Nickel
Lid Plating	2.0 to 3.0 $\mu\text{m}$ Nickel
Body	$\text{Al}_2\text{O}_3$ Ceramic



## Recommended Reflow Profile

1. Preheating shall be fixed at 150~180°C for 60~90 seconds.
2. Ascending time to preheating temperature 150°C shall be 30 seconds min.
3. Heating shall be fixed at 220°C for 50~80 seconds and at 260°C +0/-5°C peak (10 seconds).
4. Time: 5 times maximum.

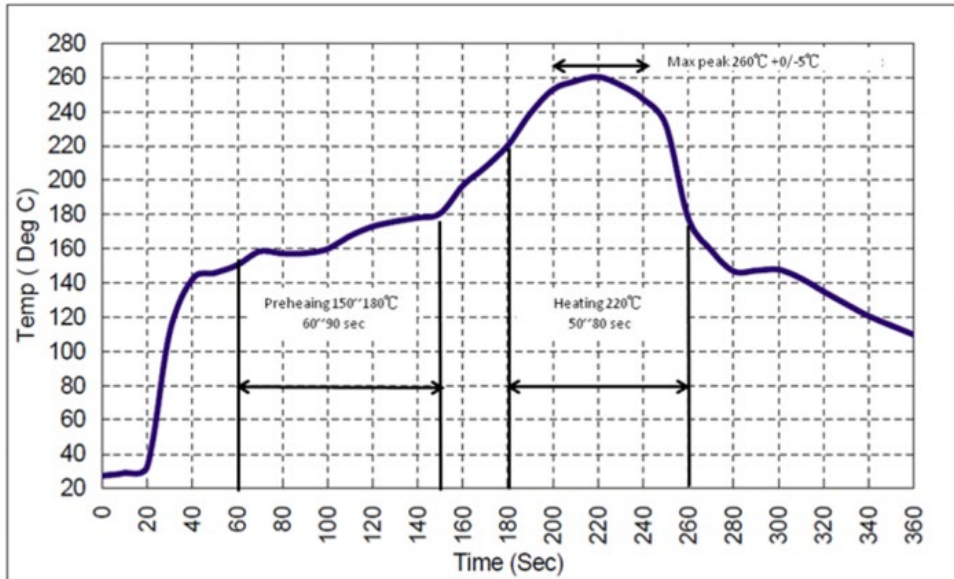

## Looking for pricing, stock, or lifecycle information?

Click below to explore more details on WIN SOURCE:

 [View SF1219K on WIN SOURCE](#)

 [RF Monolithics, Inc Information](#)

## Optimize Your Supply Chain with WIN SOURCE Solutions

-  Global Sourcing Solution
-  Obsolete Management
-  Cost Control Management
-  Shortage Management
-  Alternative Solution
-  Excess Inventory Management