



# THE DATASHEET OF SF2017E



- **Low Loss L-Band SAW Filter**
- **200 ohm Balanced Input and Output Ports**
- **Complies with Directive 2002/95/EC (RoHS)**
- **Moisture Sensitivity Level: 1**

**Maximum Rating**

Rating	Value	Units
Input Power Level	0	dBm
DC Voltage on any Non-ground Terminal	3	V
Operating Temperature Range	-40 to +85	°C
Storage Temperature Range in Tape and Reel	-40 to +85	°C
Suitable for Lead-free Soldering - Maximum Soldering Profile	260 °C for 30 s	

**SF2017E**

**1220 MHz  
SAW Filter**

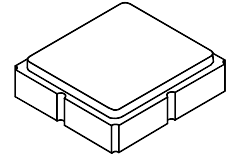

**SM3030-8**

**Electrical Characteristics**

Characteristic	Sym	Notes	Min	Typ	Max	Units
Center Frequency	$f_C$			1220		MHz
Insertion Loss, 1216 to 1224 MHz	IL			3.4	5.3	dB
Amplitude Ripple, 1216 to 1224 MHz				0.6	1.8	dB <sub>p-p</sub>
Attenuation, Referenced to 0 dB						
500 to 1129 MHz			50	57		dB
1129 to 1135 MHz			50	57		
1144 to 1152 MHz			46	57		
1132 MHz			50	57		
1148 MHz			48	57		
1176 MHz			50	56		
1184 MHz			46	55		
1290 to 2000 MHz			50	55		
Group Delay Ripple, 1216 to 1224 MHz				12		nS <sub>p-p</sub>
Balanced Source Impedance				200		ohms
Balanced Load Impedance				200		ohms

Case Style	SM3030-8 3.0 x 3.0 mm Nominal Footprint		
Lid Symbolization (Y=year, WW=week, S=shift) dot=pin 1 indicator	898, YWWS		
Standard Reel Quantity	Reel Size 7 Inch	500 Pieces/Reel	
	Reel Size 13 Inch	3000 Pieces/Reel	

	Connection	Terminals
Port 1	Balanced Input	1,2
Port 2	Balanced Output	5,6
	Ground	All Others

Dot Indicates Pin 1



**CAUTION: Electrostatic Sensitive Device. Observe precautions for handling.**

**NOTES:**

1. The design, manufacturing process, and specifications of this device are subject to change.
2. US or International patents may apply.
3. RoHS compliant from the first date of manufacture.

## Frequency Response Plots

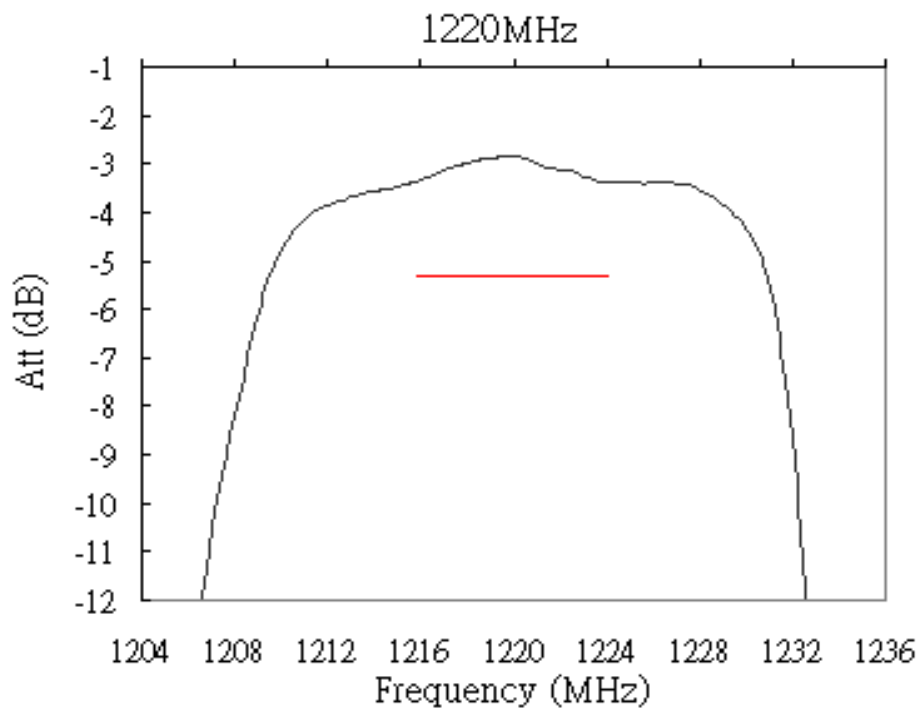
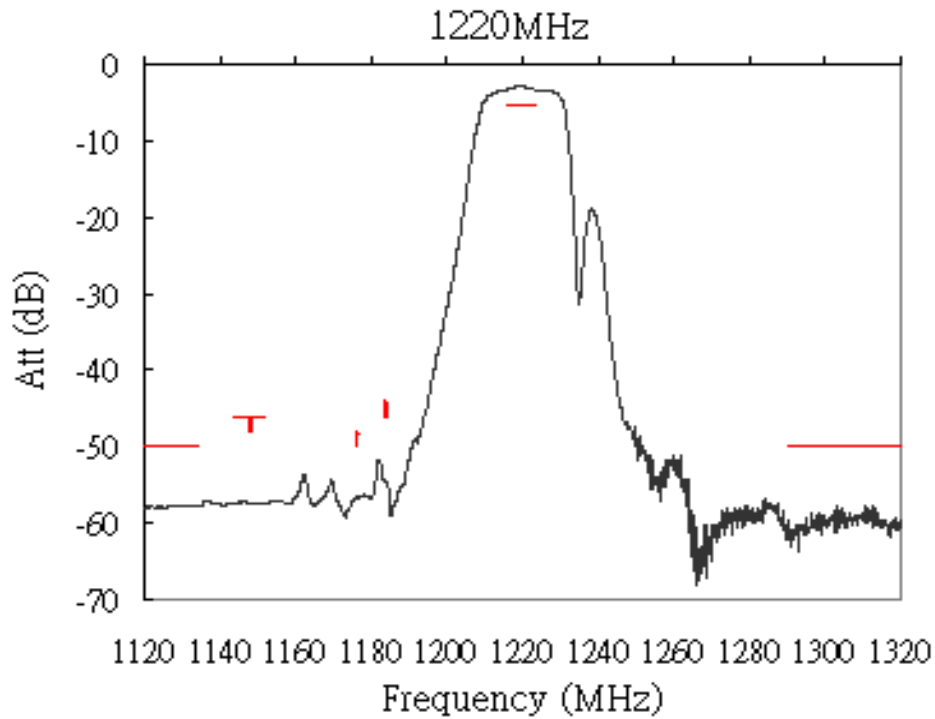

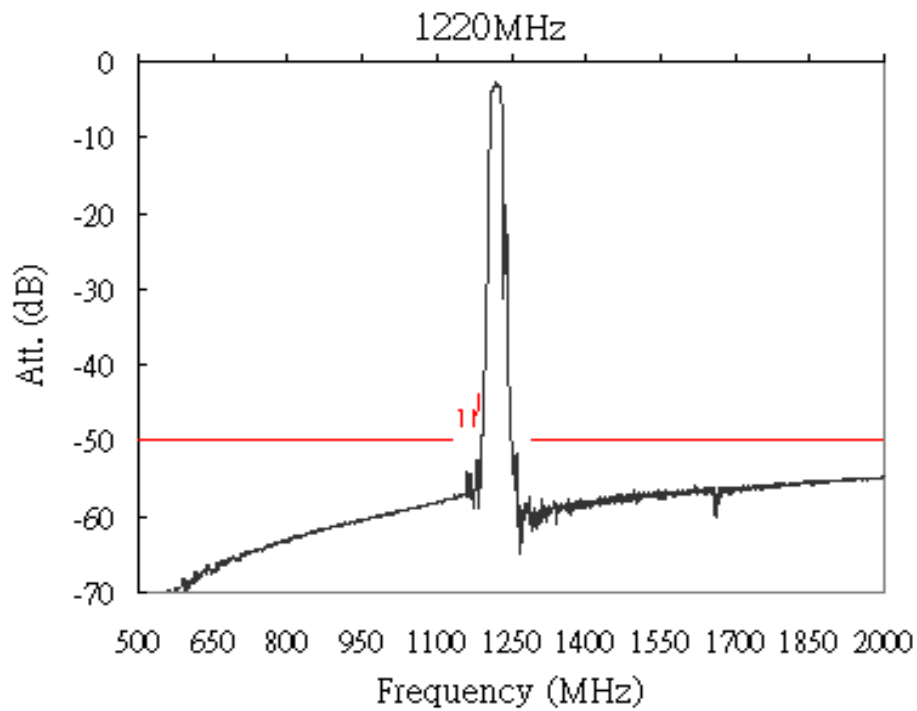

## Matching Network Topology

**SF2017E Test Circuit**

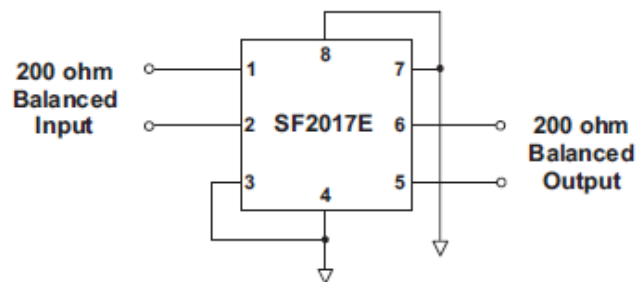

## 8-Terminal Ceramic Surface-Mount Case 3.0 X 3.0 mm Nominal Footprint

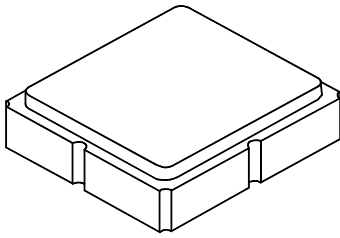

### Case and PCB Footprint Dimensions

Dimension	mm			Inches		
	Min	Nom	Max	Min	Nom	Max
A	2.87	3.0	3.13	0.113	0.118	0.123
B	2.87	3.0	3.13	0.113	0.118	0.123
C	1.14	1.27	1.40	0.045	0.050	0.055
D	0.79	0.92	1.05	0.031	0.036	0.041
E	0.62	0.75	0.88	0.024	0.029	0.034
F	0.47	0.60	0.73	0.018	0.024	0.029
G	0.47	0.60	0.73	0.018	0.024	0.029
H	1.07	1.20	1.33	0.042	0.047	0.052
I		3.19			0.126	
J		0.81			0.032	
K		0.96			0.038	
L		0.81			0.032	
M		1.39			0.055	
N		0.23			0.009	
O		0.38			0.015	

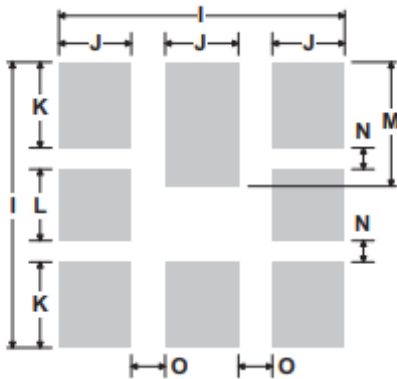

PCB Footprint Top View

### Case Materials

Materials	
Solder Pad Plating	0.3 to 1.0 $\mu\text{m}$ Gold over 1.27 to 8.89 $\mu\text{m}$ Nickel
Lid Plating	2.0 to 3.0 $\mu\text{m}$ Nickel
Body	$\text{Al}_2\text{O}_3$ Ceramic

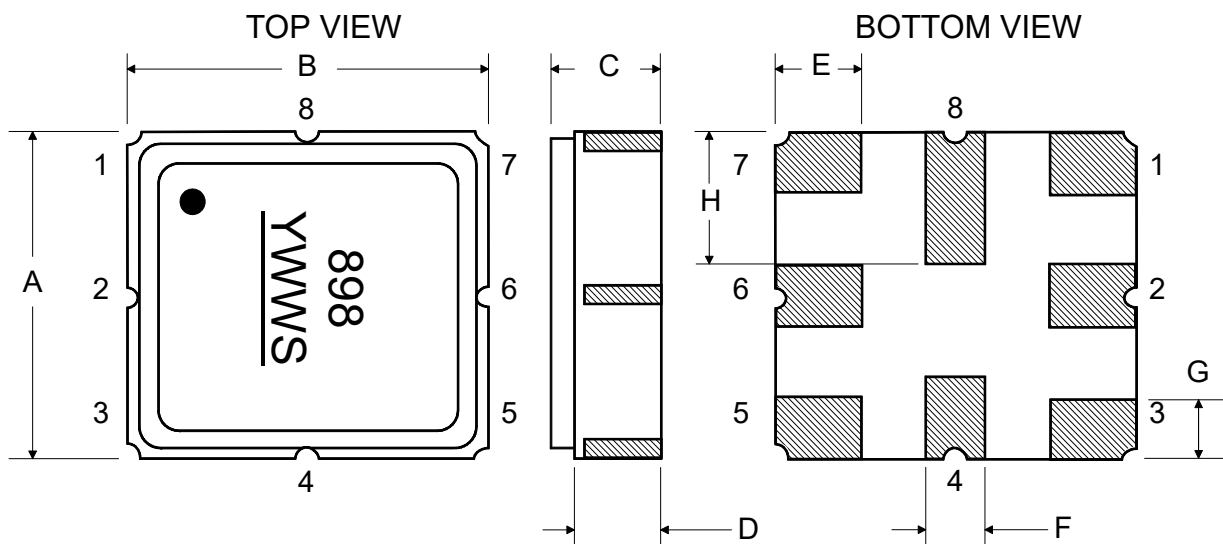

# Tape and Reel Specifications

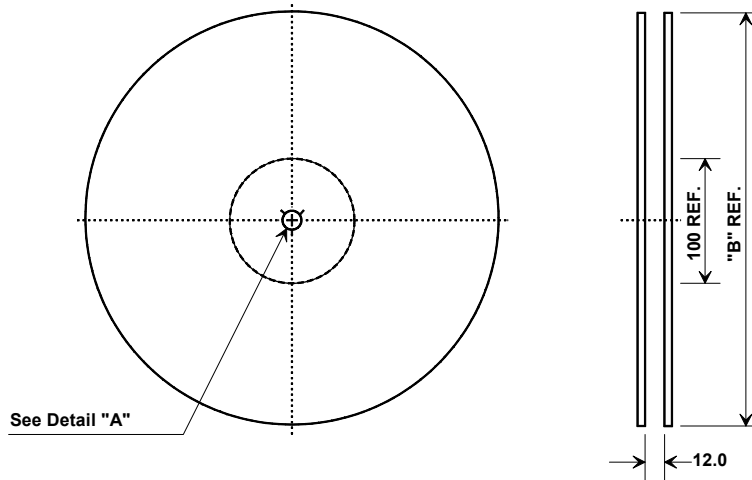

Tape and Reel Standard per ANSI/EIA-481

"B" Nominal Size		Quantity Per Reel
Inches	millimeters	
7	178	500
13	330	3000

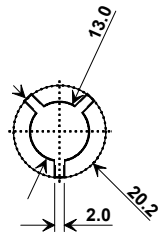

## COMPONENT ORIENTATION and DIMENSIONS

Carrier Tape Dimensions	
<b>Ao</b>	3.35 mm
<b>Bo</b>	3.35 mm
<b>Ko</b>	1.4 mm
<b>Pitch</b>	8.0 mm
<b>W</b>	12.0 mm

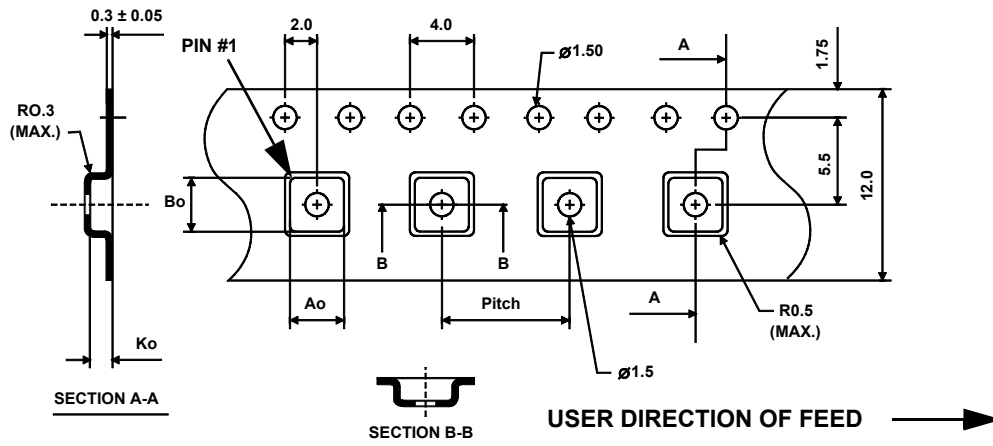

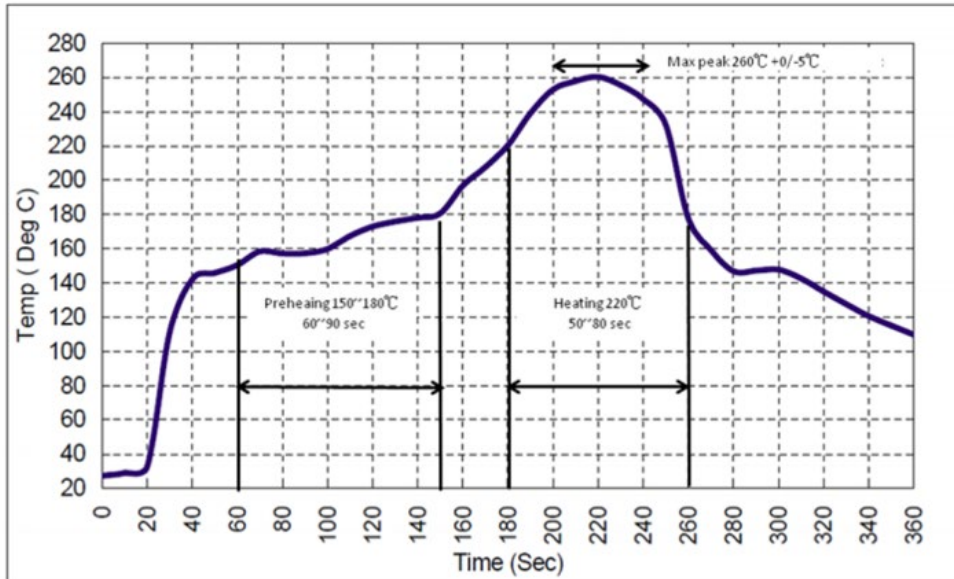

## Recommended Reflow Profile

1. Preheating shall be fixed at 150~180°C for 60~90 seconds.
2. Ascending time to preheating temperature 150°C shall be 30 seconds min.
3. Heating shall be fixed at 220°C for 50~80 seconds and at 260°C +0/-5°C peak (10 seconds).
4. Time: 5 times maximum.



## Looking for pricing, stock, or lifecycle information?

Click below to explore more details on WIN SOURCE:

-  [View SF2017E on WIN SOURCE](#)
-  [RF Monolithics, Inc Information](#)

## Optimize Your Supply Chain with WIN SOURCE Solutions

-  Global Sourcing Solution
-  Obsolete Management
-  Cost Control Management
-  Shortage Management
-  Alternative Solution
-  Excess Inventory Management