



**THE DATASHEET OF
MP3216GJE-Z**





The Future of Analog IC Technology®

MP3216

36V, 1.3MHz, 0.75A Step-up Converter With Output Disconnect

DESCRIPTION

The MP3216 is a monolithic step up converter integrating a 0.75A, 0.6Ω internal switch. The MP3216 uses current mode, fixed frequency architecture to regulate the output voltage, providing fast transient response and cycle by cycle current limit.

The MP3216 includes under-voltage lockout, over voltage protection and thermal overload protection preventing damage in the event of an output overload.

In addition, the MP3216 can disconnect all loads from input DC power supply. The output short circuit protection prevents the Schottky diode and IC from damage.

The MP3216 is available in small 6-pin TSOT23-6 package and 5-pin TSOT23-5 package.

FEATURES

- Internal 0.6Ω Power MOSFET
- Up to 36V Output Voltage
- 1.3MHz Fixed Switching Frequency
- 42V Over Voltage Shutdown
- Cycle-by-Cycle Over Current Protection
- UVLO, Thermal Shutdown
- Output Disconnection
- Output Short Protection
- Available in TSOT23-6, and TSOT23-5 Packages

APPLICATIONS

- Portable Applications
- Handheld Computers and PDAs
- Digital Still Cameras

All MPS parts are lead-free, halogen free, and adhere to the RoHS directive. For MPS green status, please visit MPS website under Quality Assurance.

“MPS” and “The Future of Analog IC Technology” are Registered Trademarks of Monolithic Power Systems, Inc.

TYPICAL APPLICATION

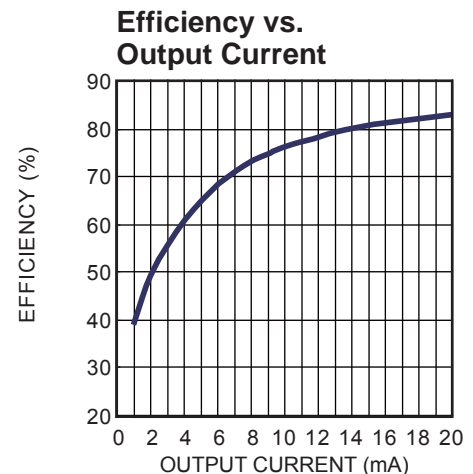
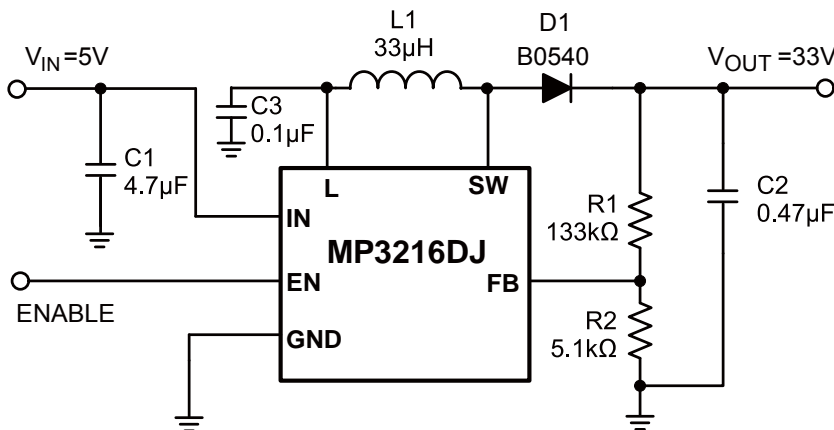

ORDERING INFORMATION (MP3216DJ)

Part Number*	Package	Top Marking	Free Air Temperature (T _A)
MP3216DJ	TSOT23-6	<i>See Below</i>	-40°C to +85°C

* For Tape & Reel, add suffix –Z (e.g. MP3216DJ–Z);
 For RoHS Compliant Packaging, add suffix –LF (e.g. MP3216DJ–LF–Z)

TOP MARKING (MP3216DJ)

| 6HYW

6H: Product code of MP3216DJ
 Y: Year code
 W: Week code

ORDERING INFORMATION (MP3216GJE)

Part Number*	Package	Top Marking
MP3216GJE	TSOT23-5	<i>See Below</i>

* For Tape & Reel, add suffix –Z (e.g. MP3216GJE–Z)

TOP MARKING (MP3216GJE)

| 6HYW

6H: Product code of MP3216GJE
 Y: Year code
 W: Week code

PACKAGE REFERENCE

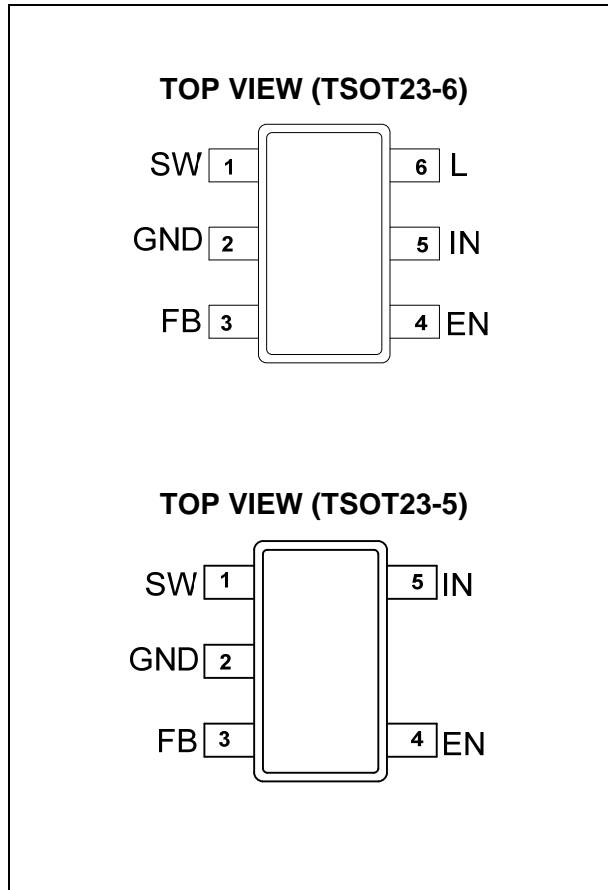

Absolute Maximum Ratings ⁽¹⁾

SW Pin.....	-0.5V (-1.5V for 20ns) to +40V
All Other Pins.....	-0.3V to +6.5V
Continuous Power Dissipation (T _A = +25°C) ⁽²⁾	0.56 W
Junction Temperature.....	150°C
Lead Temperature.....	260°C
Storage Temperature.....	-55°C to +150°C

Recommended Operating Conditions ⁽³⁾

IN Supply Voltage.....	2.5V to 6V
SW Pin.....	V _{IN} to 36V
Maximum Junction Temp. (T _J).....	+125°C

Thermal Resistance ⁽⁴⁾ θ_{JA} θ_{JC}

TSOT23-6, TSOT23-5	220	110	°C/W
--------------------------	-----	-----	------

Notes:

- 1) Exceeding these ratings may damage the device.
- 2) The maximum allowable power dissipation is a function of the maximum junction temperature T_J(MAX), the junction-to-ambient thermal resistance θ_{JA}, and the ambient temperature T_A. The maximum allowable continuous power dissipation at any ambient temperature is calculated by P_D(MAX)=(T_J(MAX)-T_A)/θ_{JA}. Exceeding the maximum allowable power dissipation will cause excessive die temperature, and the regulator will go into thermal shutdown. Internal thermal shutdown circuitry protects the device from permanent damage.
- 3) The device is not guaranteed to function outside of its operating conditions.
- 4) Measured on JESD51-7, 4-layer PCB.

ELECTRICAL CHARACTERISTICS

$V_{IN} = V_{EN} = 5V$, $T_A = +25^{\circ}C$, unless otherwise noted.

Parameters	Symbol	Condition	Min	Typ	Max	Units
Operating Input Voltage	V_{IN}		2.5		6	V
Supply Current (Shutdown)		$V_{EN} = 0V$			10	μA
Supply Current (Quiescent)		$V_{FB} = 0.15V$		550	650	μA
Switching Frequency	f_{SW}		1.0	1.3	1.5	MHz
Maximum Duty Cycle		$V_{FB} = 0V$	92			%
Under Voltage Lockout						
IN Under Voltage Lockout	UVLO	V_{IN} Rising		2.25	2.45	V
Under Voltage Lockout Hysteresis				92		mV
Over Voltage Shutdown Threshold	V_{OV}	V_{OV} Rising		42		V
Enable						
EN OFF Threshold		V_{EN} Falling	0.8			V
EN ON Threshold		V_{EN} Rising			2	V
Feedback						
FB Voltage	V_{FB}		1.20	1.24	1.28	V
FB Input Bias Current		$V_{FB} = 1.2V$		70		nA
Output Switch						
SW On-Resistance	R_{ON}			600		m Ω
SW Current Limit		Duty Cycle = 60%		0.75		A
Thermal Shutdown				150		$^{\circ}C$
Output Disconnect Switch						
N-CH On-Resistance ⁽⁵⁾				300		m Ω
Inrush Current Limit ⁽⁵⁾		$V_L < (V_{IN} - 0.3V)$		0.21		A

Notes:

5) Only for MP3216DJ which is in TSOT23-6 package.

PIN FUNCTIONS

Pin #	Name (TSOT23-6)	Name (TSOT23-5)	Pin Function
1	SW	SW	Power Switch Output. SW is the drain of the internal MOSFET switch. Connect the power inductor and output rectifier to SW.
2	GND	GND	Ground.
3	FB	FB	Feedback Input. Reference voltage is 1.24V, Connect a resistor divider from the output to this pin.
4	EN	EN	ON/OFF Control Input. A voltage greater than 2V will turn the part on and less than 0.8V will turn the part off. When not used, tie EN to the input source for automatic startup.
5	IN	IN	Input Supply Pin. IN is the drain of the internal disconnecting N-channel MOSFET. Must be locally bypassed.
6	L	-	Inductor Output Pin. L is the source/body of the internal disconnecting N-channel MOSFET. Connect the inductor to this pin.

TYPICAL PERFORMANCE CHARACTERISTICS

Circuit in figure 2, $V_{IN}=5V$, $V_{OUT}=33V$, $T_A=+25^{\circ}C$, unless otherwise noted.

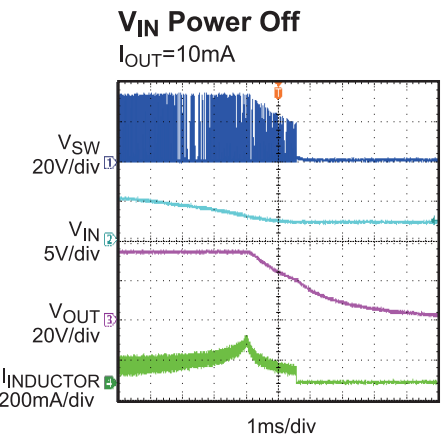
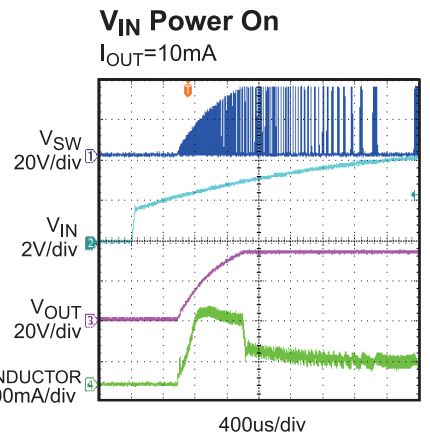
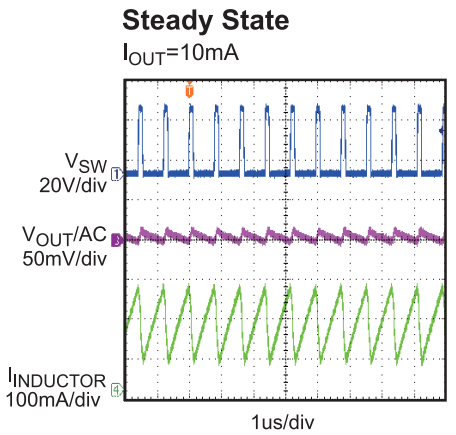
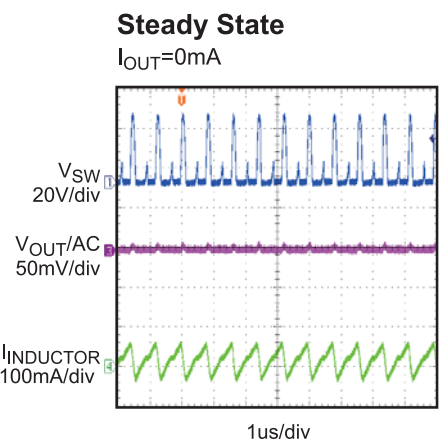
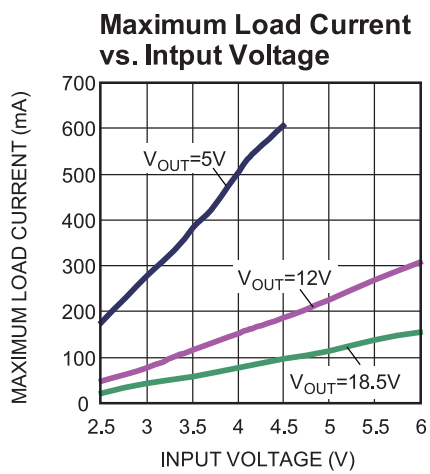
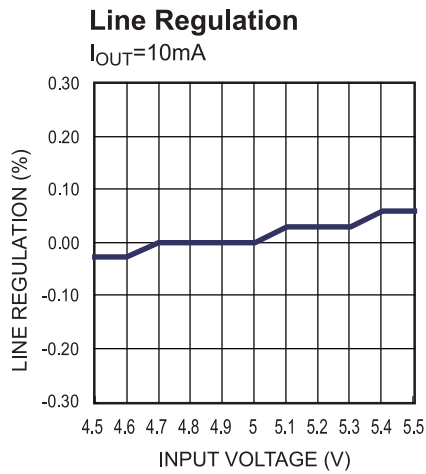
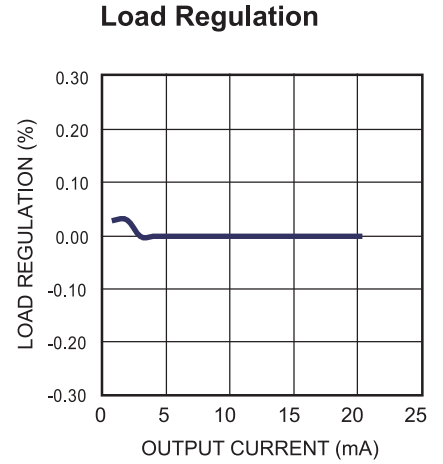
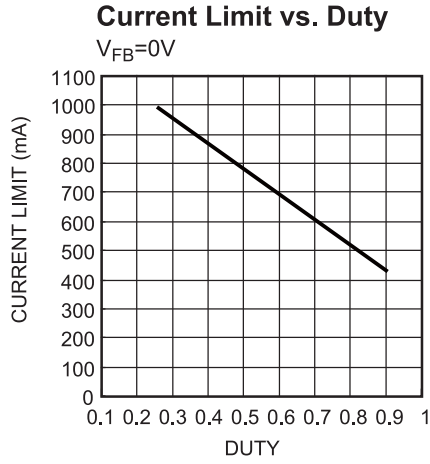
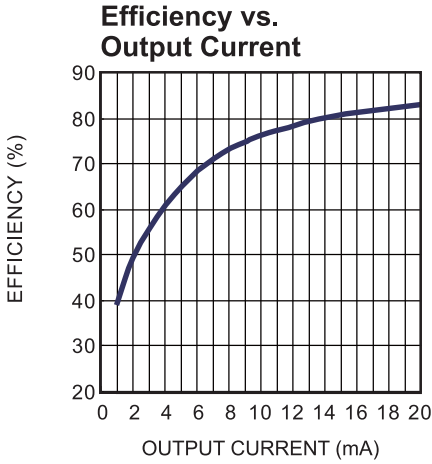

TYPICAL PERFORMANCE CHARACTERISTICS (continued)

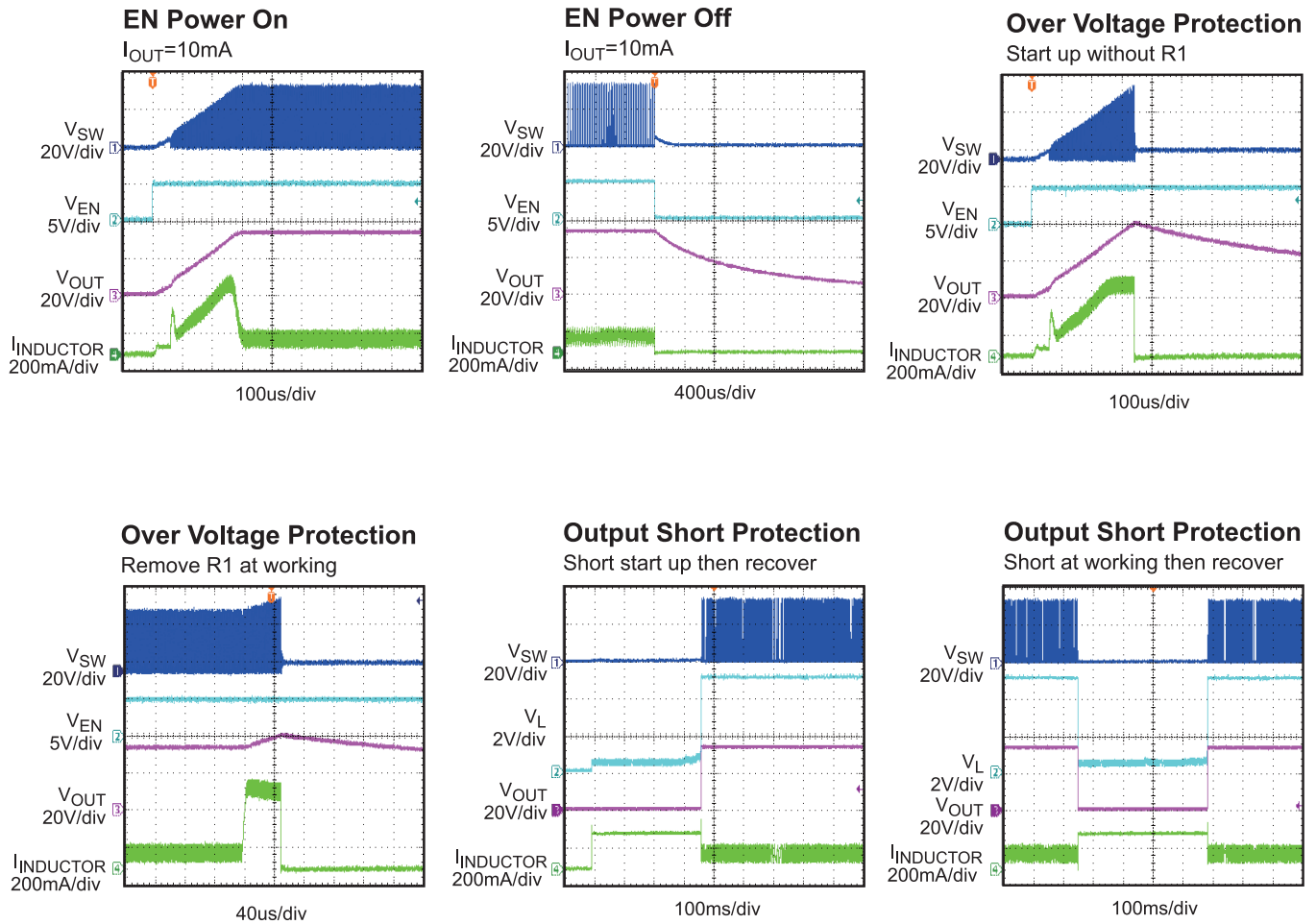
 Circuit in figure 2, $V_{IN}=5V$, $V_{OUT}=33V$, $T_A=+25^{\circ}C$, unless otherwise noted.

OPERATION

The MP3216 uses a constant frequency, peak current mode boost regulator architecture to regulate the output voltage. The operation of the MP3216 can be understood by referring to the block diagram of Figure 1.

At the start of each oscillator cycle the FET is turned on through the control circuitry. To prevent sub-harmonic oscillations at duty cycles greater than 50 percent, a stabilizing ramp is added to the output of the current sense amplifier and the result is fed into the positive input of the PWM comparator. When this voltage equals the output voltage of the error amplifier the power FET is turned off.

The voltage at the output of the error amplifier is an amplified version of the difference between the 1.24V reference voltage and the feedback voltage. In this way the peak current level keeps the output in regulation.

If the feedback voltage starts to drop, the output of the error amplifier increases. This results in more current flowing through the power FET, thus increasing the power delivered to the output.

Over voltage protection shuts off the MP3216 if the output voltage goes too high. In some cases, loose high side resistor or improper divided resistor; this results in the feedback voltage is always below reference. The part runs at maximum duty cycle boosting the output voltage higher and higher. If the output ever exceeds 42V, the part shuts down. And It does not switch again until the power is recycled.

The MP3216 also has output short protection function in TSOT23-6 package device. When short condition occurs, switching stops and internal disconnecting N-MOSFET limits the inductor current to 210mA, which prevents the freewheel diode and IC from damaging. Once short condition is released, the system returns to normal operation.

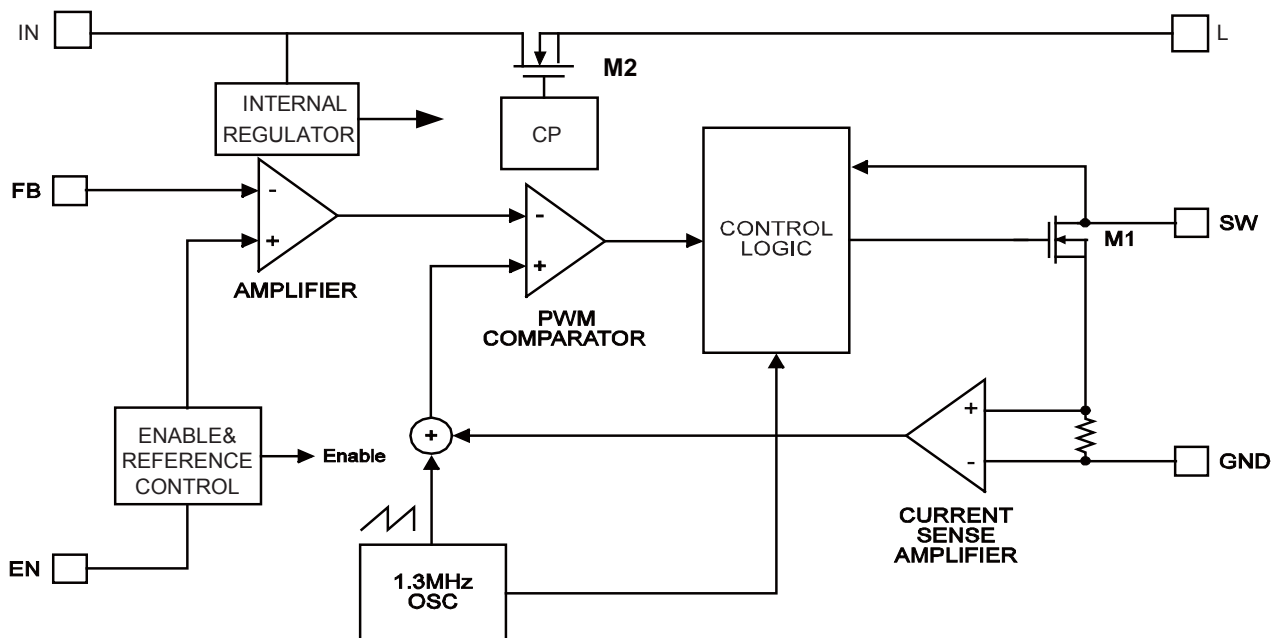

Figure 1—Functional Block Diagram

APPLICATION INFORMATION

Components referenced below apply to Typical Application Circuit in figure 2.

Setting the Output Voltage

Set the output voltage by selecting the resistive voltage divider ratio. Use 5.1kΩ for the low-side resistor R2 of the voltage divider. Determine the high-side resistor R1 by the equation:

$$R1 = \frac{R2 \times (V_{OUT} - V_{FB})}{V_{FB}}$$

Where, V_{OUT} is the output voltage, $V_{FB} = 1.24V$.

For $R2 = 5.1k\Omega$ and $V_{OUT} = 33V$, then

$R1 = 130.6k\Omega$. There choose a 133kΩ standard 1% value.

Selecting the Input Capacitor

An input capacitor is required to supply the AC ripple current to the inductor, while limiting noise at the input source. This capacitor must have low ESR, so ceramic is the best choice. Use an input capacitor value of 4.7μF or greater. This capacitor must be placed physically close to the IN pin. Since it reduces the voltage ripple seen at IN, it also reduces the amount of EMI passed back along that line to the other circuitry.

To minimize the ripple to the inductor, use a smaller ceramic capacitor value of 0.1μF placed physically close to the L pin.

Selecting the Output Capacitor

The output capacitor is required to maintain the DC output voltage. Low ESR capacitors are preferred to keep the output voltage ripple to a minimum. The characteristic of the output capacitor also affects the stability of the regulation control system. Ceramic, tantalum, or low ESR electrolytic capacitors are recommended. In the case of ceramic capacitors, the impedance of the capacitor at the switching frequency is dominated by the capacitance, and so the output voltage ripple is mostly independent of the ESR. The output voltage ripple is estimated to be:

$$V_{RIPPLE} \approx \frac{\left(1 - \frac{V_{IN}}{V_{OUT}}\right) \times I_{LOAD}}{C2 \times f_{SW}}$$

Where V_{RIPPLE} is the output ripple voltage, V_{IN} and V_{OUT} are the DC input and output voltages respectively, I_{LOAD} is the load current, f_{SW} is the switching frequency, and C2 is the capacitance of the output capacitor.

Selecting the Inductor

The inductor is required to force the higher output voltage while being driven by the lower input voltage. A larger value inductor results in less ripple current that results in lower peak inductor current, reducing stress on the internal power switch. However, the larger value inductor has a larger physical size, higher series resistance, and/or lower saturation current.

Inductance from 2.2μH to 33μH is a good choice for high efficiency and small size. To prevent saturation, use an inductor with a saturation current rating that is higher than the device current limit.

Selecting the Diode

The output rectifier diode supplies current to the inductor when the internal power MOSFET is off. To reduce losses due to diode forward voltage and recovery time, use a Schottky diode with the MP3216. The diode should be rated for a reverse voltage equal to or greater than the output voltage used. The average current rating must be greater than the maximum load current expected, and the peak current rating must be greater than the peak inductor current.

Layout Consideration

High frequency switching regulators require very careful layout for stable operation and low noise. All components must be placed as close to the IC as possible. Keep the path between the SW pin, output diode, output capacitor and GND pin extremely short for minimal noise and ringing. The input capacitor must be placed close to the IN pin for best decoupling. All feedback components must be kept close to the FB pin to prevent noise injection on the FB pin trace. The ground return of the input and output capacitors should be tied close to the GND pin. See the MP3216 demo board layout for reference.

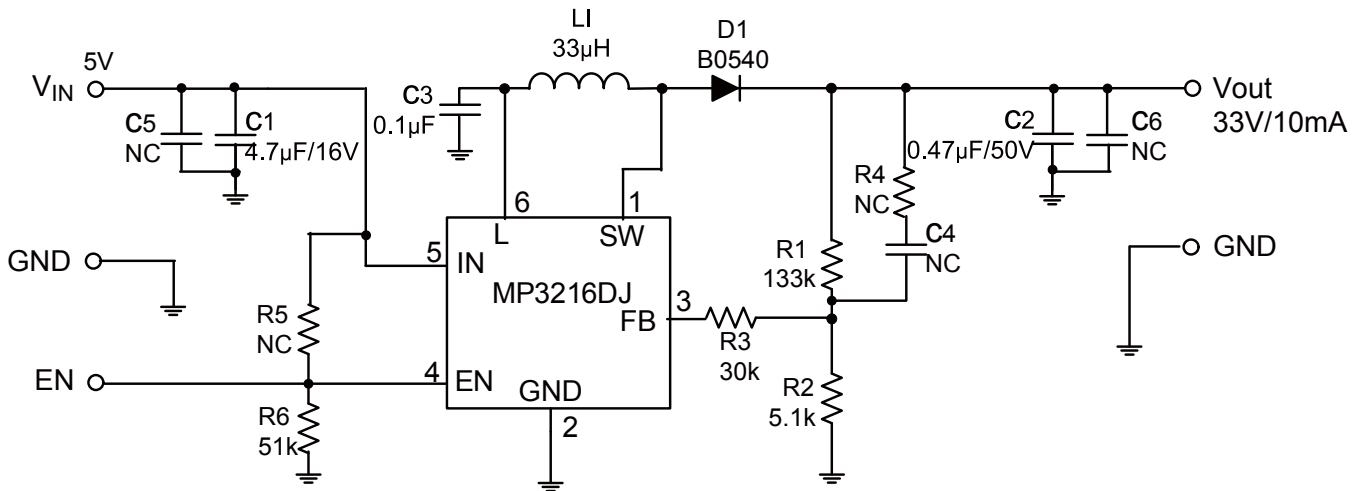
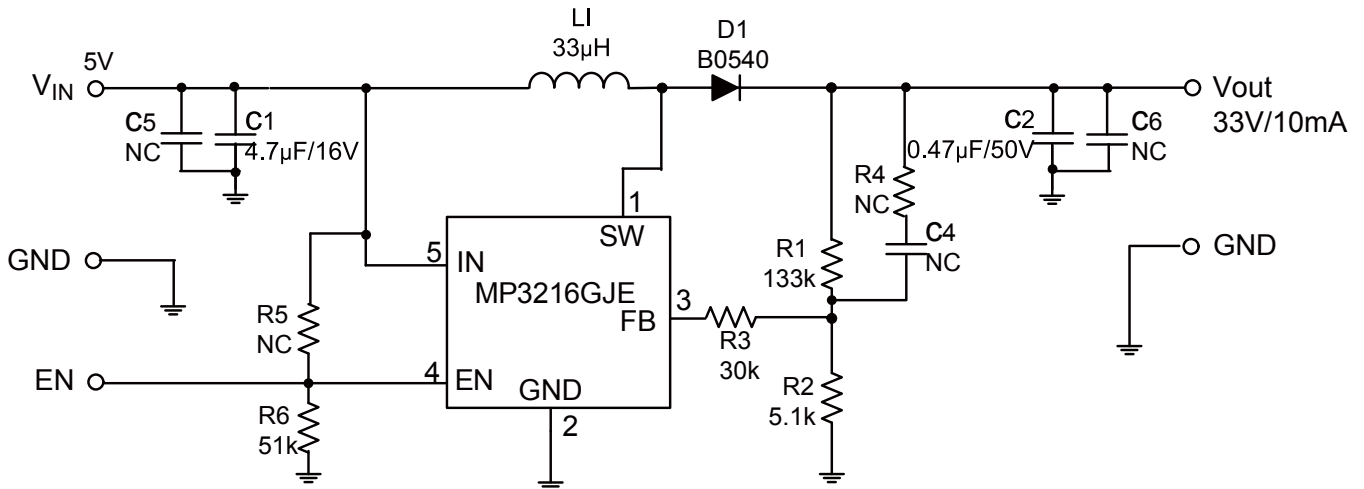
TYPICAL APPLICATION CIRCUIT

Figure 2— $V_{IN}=5V$ $V_{OUT}=33V$ $I_{OUT}=10mA$ Boost Circuit with TSOT23-6 Package

Figure 3— $V_{IN}=5V$ $V_{OUT}=33V$ $I_{OUT}=10mA$ Boost Circuit with TSOT23-5 Package

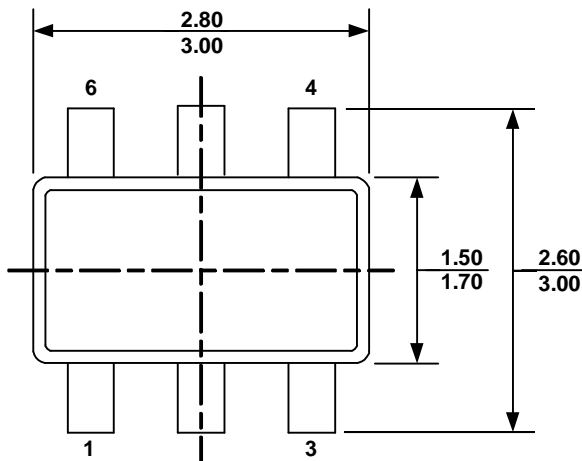
PACKAGE INFORMATION

TSOT23-6

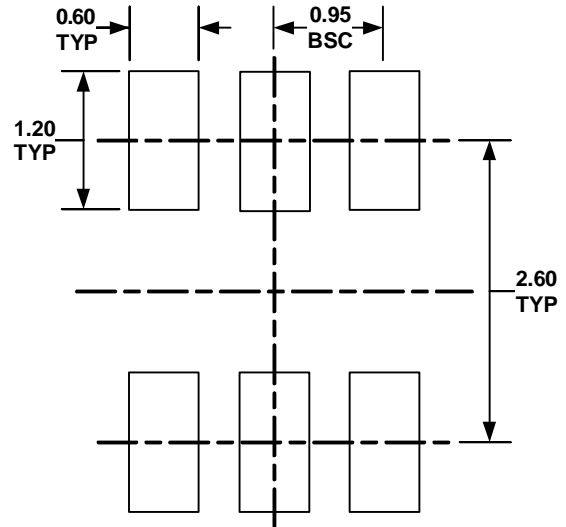

TOP VIEW



RECOMMENDED LAND PATTERN

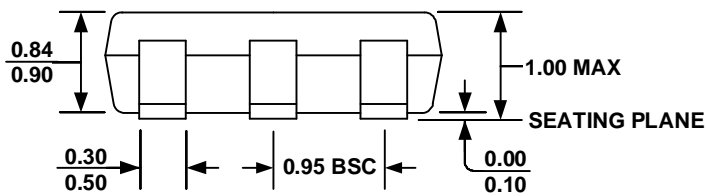

FRONT VIEW

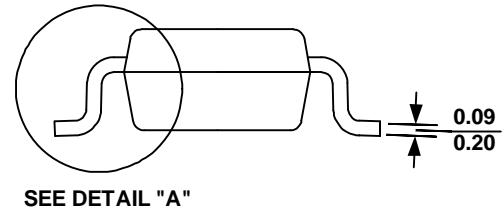

SIDE VIEW

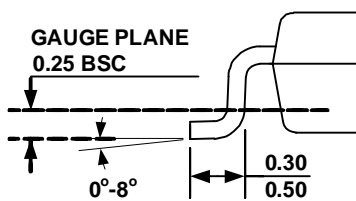

DETAIL 摺 ?

NOTE:

- 1) ALL DIMENSIONS ARE IN MILLIMETERS
- 2) PACKAGE LENGTH DOES NOT INCLUDE MOLD FLASH, PROTRUSION OR GATE BURR.
- 3) PACKAGE WIDTH DOES NOT INCLUDE INTERLEAD FLASH OR PROTRUSION.
- 4) LEAD COPLANARITY (BOTTOM OF LEADS AFTER FORMING) SHALL BE 0.10 MILLIMETERS MAX.
- 5) DRAWING CONFORMS TO JEDEC MO-193, VARIATION AA.
- 6) DRAWING IS NOT TO SCALE.

PACKAGE INFORMATION

TSOT23-5

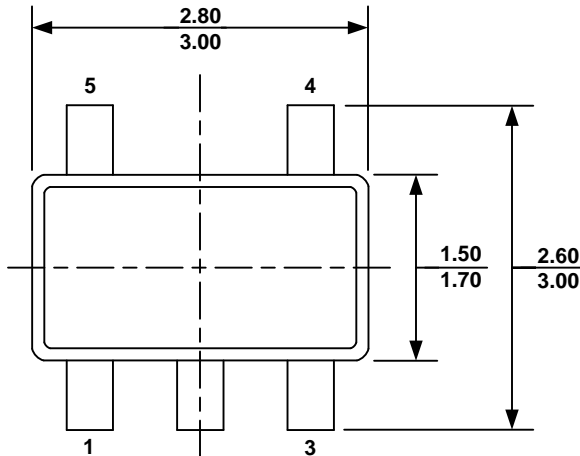

TOP VIEW

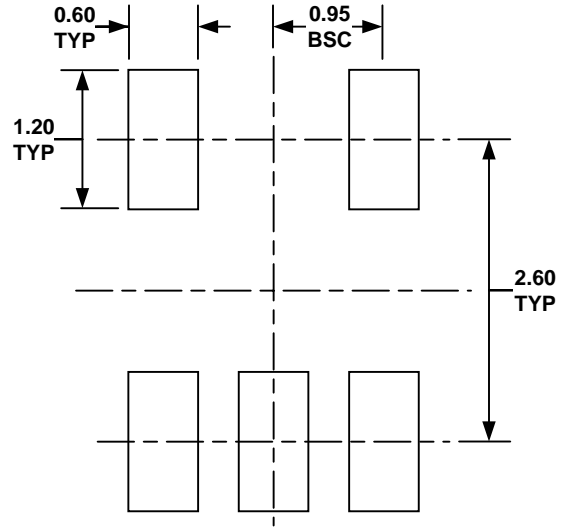

RECOMMENDED LAND PATTERN

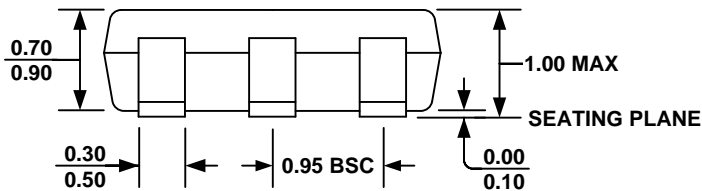

FRONT VIEW

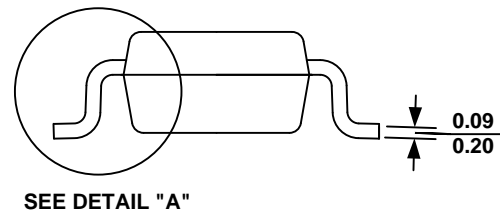

SIDE VIEW

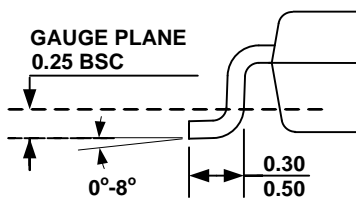

DETAIL "A"



NOTE:

- 1) ALL DIMENSIONS ARE IN MILLIMETERS.
- 2) PACKAGE LENGTH DOES NOT INCLUDE MOLD FLASH, PROTRUSION OR GATE BURR.
- 3) PACKAGE WIDTH DOES NOT INCLUDE INTERLEAD FLASH OR PROTRUSION.
- 4) LEAD COPLANARITY (BOTTOM OF LEADS AFTER FORMING) SHALL BE 0.10 MILLIMETERS MAX.
- 5) DRAWING CONFORMS TO JEDEC MO-193, VARIATION AA.
- 6) DRAWING IS NOT TO SCALE.

NOTICE: The information in this document is subject to change without notice. Users should warrant and guarantee that third party Intellectual Property rights are not infringed upon when integrating MPS products into any application. MPS will not assume any legal responsibility for any said applications.

Looking for pricing, stock, or lifecycle information?

Click below to explore more details on WIN SOURCE:

-  [View MP3216GJE-Z on WIN SOURCE](#)
-  [Monolithic Power Systems Inc. Information](#)

Optimize Your Supply Chain with WIN SOURCE Solutions

-  Global Sourcing Solution
-  Obsolete Management
-  Cost Control Management
-  Shortage Management
-  Alternative Solution
-  Excess Inventory Management