



**THE DATASHEET OF  
DAC7744EC**





# DAC7744



For most current data sheet and other product information, visit [www.burr-brown.com](http://www.burr-brown.com)

## 16-Bit, Quad Voltage Output DIGITAL-TO-ANALOG CONVERTER

### FEATURES

- **LOW POWER: 200mW**
- **UNIPOLAR OR BIPOLAR OPERATION**
- **SINGLE-SUPPLY OUTPUT RANGE: +10V**
- **DUAL SUPPLY OUTPUT RANGE:  $\pm 10V$**
- **SETTLING TIME: 10 $\mu$ s to 0.003%**
- **16-BIT MONOTONICITY:  $-40^{\circ}C$  to  $+85^{\circ}C$**
- **PROGRAMMABLE RESET TO MID-SCALE OR ZERO-SCALE**
- **DATA READBACK**
- **DOUBLE-BUFFERED DATA INPUTS**

### APPLICATIONS

- **PROCESS CONTROL**
- **ATE PIN ELECTRONICS**
- **CLOSED-LOOP SERVO-CONTROL**
- **MOTOR CONTROL**
- **DATA ACQUISITION SYSTEMS**
- **DAC-PER-PIN PROGRAMMERS**

### DESCRIPTION

The DAC7744 is a 16-bit, quad voltage output digital-to-analog converter with guaranteed 16-bit monotonic performance over the specified temperature range. It accepts 16-bit parallel input data, has double-buffered DAC input logic (allowing simultaneous update of all DACs), and provides a readback mode of the internal input registers. Programmable asynchronous reset clears all registers to a mid-scale code of 8000<sub>H</sub> or to a zero-scale of 0000<sub>H</sub>. The DAC7744 operates from either a single +15V supply or from a +15V, -15V, and +5V supply.

Low power and small size per DAC make the DAC7744 ideal for automatic test equipment, DAC-per-pin programmers, data acquisition systems, and closed-loop servo-control. The DAC7744 is available in a 48-lead SSOP package, and offers guaranteed specifications over the  $-40^{\circ}C$  to  $+85^{\circ}C$  temperature range.

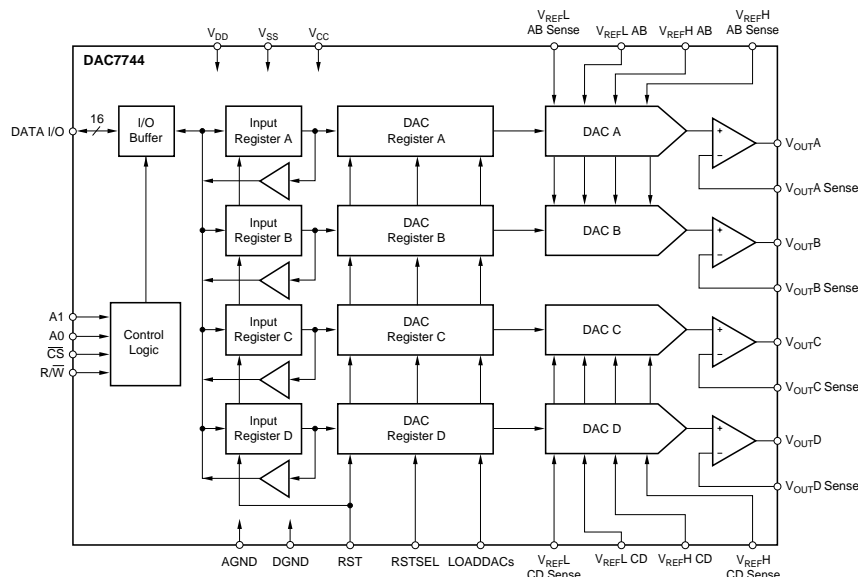

International Airport Industrial Park • Mailing Address: PO Box 11400, Tucson, AZ 85734 • Street Address: 6730 S. Tucson Blvd., Tucson, AZ 85706 • Tel: (520) 746-1111  
Twx: 910-952-1111 • Internet: <http://www.burr-brown.com/> • Cable: BBRCORP • Telex: 066-6491 • FAX: (520) 889-1510 • Immediate Product Info: (800) 548-6132

# SPECIFICATIONS (Dual Supply)

At  $T_A = T_{MIN}$  to  $T_{MAX}$ ,  $V_{CC} = +15V$ ,  $V_{DD} = +5V$ ,  $V_{SS} = -15V$ ,  $V_{REFH} = +10V$ , and  $V_{REFL} = -10V$ , unless otherwise noted.

PARAMETER	CONDITIONS	DAC7744E			DAC7744EB			DAC7744EC			UNITS
		MIN	TYP	MAX	MIN	TYP	MAX	MIN	TYP	MAX	
<b>ACCURACY</b>											
Linearity Error $T_{MIN}$ to $T_{MAX}$	$T = 25^{\circ}C$			$\pm 3$ $\pm 4$			*			$\pm 2$ $\pm 3$	LSB LSB
Linearity Match			$\pm 4$			*			$\pm 2$		LSB
Differential Linearity Error $T_{MIN}$ to $T_{MAX}$	$T = 25^{\circ}C$			$\pm 3$ $\pm 3$					$\pm 2$ $\pm 2$		LSB LSB
Monotonicity, $T_{MIN}$ to $T_{MAX}$		14			15			16			Bits
Bipolar Zero Error	$T = 25^{\circ}C$		$\pm 0.01$	$\pm 0.025$			*			*	% of FSR
Bipolar Zero Error, $T_{MIN}$ to $T_{MAX}$				$\pm 0.05$			*			*	% of FSR
Full-Scale Error	$T = 25^{\circ}C$			$\pm 0.025$			*			*	% of FSR
Full-Scale Error, $T_{MIN}$ to $T_{MAX}$				$\pm 0.05$			*			*	% of FSR
Bipolar Zero Matching	Channel-to-Channel Matching			$\pm 0.024$			*			*	% of FSR
Full-Scale Matching	Channel-to-Channel Matching			$\pm 0.024$			*			*	% of FSR
Power Supply Rejection Ratio (PSRR)	At Full Scale			25			*			*	ppm/V
<b>ANALOG OUTPUT</b>											
Voltage Output		$V_{REFL}$		$V_{REFH}$	*		*	*		*	V
Output Current		$\pm 5$			*		*	*		*	mA
Maximum Load Capacitance			500			*		*	*	*	pF
Short-Circuit Current			$\pm 20$			*		*	*	*	mA
Short-Circuit Duration	To $V_{SS}$ , $V_{DD}$ or GND		Indefinite			*		*	*	*	
<b>REFERENCE INPUT</b>											
Ref High Input Voltage Range		$V_{REFL} + 1.25$		+10	*		*	*		*	V
Ref Low Input Voltage Range		-10		$V_{REFH} - 1.25$	*		*	*		*	V
Ref High Input Current		-0.3		2.6		*			*	*	mA
Ref Low Input Current		-3.2		-0.3		*			*	*	mA
<b>DYNAMIC PERFORMANCE</b>											
Settling Time	To $\pm 0.003\%$ , 20V Output Step		9	11		*	*		*	*	$\mu s$
Channel-to-Channel Crosstalk	See Figure 5		0.5			*			*	*	LSB
Digital Feedthrough			2			*			*	*	nV-s
Output Noise Voltage	$f = 10kHz$		60			*			*	*	$nV/\sqrt{Hz}$
<b>DIGITAL INPUT</b>											
$V_{IH}$		$0.7 \cdot V_{DD}$		$V_{DD}$	*			*		*	V
$V_{IL}$		0		$0.3 \cdot V_{DD}$			*			*	V
$I_{IH}$				$\pm 10$			*			*	$\mu A$
$I_{IL}$				$\pm 10$			*			*	$\mu A$
<b>DIGITAL OUTPUT</b>											
$V_{OH}$	$I_{OH} = -0.8mA$	3.6	4.5		*	*		*	*	*	V
$V_{OL}$	$I_{OL} = 1.6mA$		0.3	0.4		*	*		*	*	V
<b>POWER SUPPLY</b>											
$V_{DD}$		+4.75	+5.0	+5.25	*	*	*	*	*	*	V
$V_{CC}$		+14.25	+15.0	+15.75	*	*	*	*	*	*	V
$V_{SS}$		-14.25	-15.0	-15.75	*	*	*	*	*	*	V
$I_{DD}$			50			*		*	*	*	$\mu A$
$I_{CC}$			6			*		*	*	*	mA
$I_{SS}$			-5			*		*	*	*	mA
Power			170	200		*		*	*	*	mW
<b>TEMPERATURE RANGE</b>											
Specified Performance		-40		+85	*		*	*		*	$^{\circ}C$

\* Specifications same as grade to the left.

The information provided herein is believed to be reliable; however, BURR-BROWN assumes no responsibility for inaccuracies or omissions. BURR-BROWN assumes no responsibility for the use of this information, and all use of such information shall be entirely at the user's own risk. Prices and specifications are subject to change without notice. No patent rights or licenses to any of the circuits described herein are implied or granted to any third party. BURR-BROWN does not authorize or warrant any BURR-BROWN product for use in life support devices and/or systems.

# SPECIFICATIONS (Single Supply)

At  $T_A = T_{MIN}$  to  $T_{MAX}$ ,  $V_{CC} = +15V$ ,  $V_{DD} = +5V$ ,  $V_{SS} = GND$ ,  $V_{REFH} = +10V$ , and  $V_{REFL} = +50mV$ , unless otherwise noted.

PARAMETER	CONDITIONS	DAC7744E			DAC7744EB			DAC7744EC			UNITS
		MIN	TYP	MAX	MIN	TYP	MAX	MIN	TYP	MAX	
<b>ACCURACY</b>											
Linearity Error <sup>(1)</sup> $T_{MIN}$ to $T_{MAX}$	$T = 25^\circ C$			$\pm 3$ $\pm 4$			*			$\pm 2$ $\pm 3$	LSB LSB
Linearity Match			$\pm 4$			*			$\pm 2$		LSB
Differential Linearity Error $T_{MIN}$ to $T_{MAX}$	$T = 25^\circ C$			$\pm 3$ $\pm 3$					$\pm 2$ $\pm 2$		LSB LSB
Monotonicity, $T_{MIN}$ to $T_{MAX}$	$T = 25^\circ C$	14	$\pm 0.01$	$\pm 0.025$	15			16		*	Bits
Unipolar Zero	$T = 25^\circ C$			$\pm 0.05$			*			*	% of FSR
Unipolar Zero Error, $T_{MIN}$ to $T_{MAX}$				$\pm 0.05$			*			*	% of FSR
Full-Scale Error	$T = 25^\circ C$			$\pm 0.025$			*			*	% of FSR
Full-Scale Error, $T_{MIN}$ to $T_{MAX}$				$\pm 0.05$			*			*	% of FSR
Unipolar Zero Matching	Channel-to-Channel Matching			$\pm 0.024$			*			*	% of FSR
Full-Scale Matching	Channel-to-Channel Matching			$\pm 0.024$			*			*	% of FSR
Power Supply Rejection Ratio (PSRR)	At Full Scale			25			*			*	ppm/V
<b>ANALOG OUTPUT</b>											
Voltage Output	$V_{REFL} = 0V$ , $V_{SS} = 0V$ $R = 10k\Omega$	0		$V_{REFH}$	*		*	*		*	V
Output Current		$\pm 5$			*			*		*	mA
Maximum Load Capacitance			500			*		*	*	*	pF
Short-Circuit Current			$\pm 20$			*		*	*	*	mA
Short-Circuit Duration	To $V_{SS}$ , $V_{CC}$ or GND		Indefinite			*		*	*	*	
<b>REFERENCE INPUT</b>											
Ref High Input Voltage Range		$V_{REFL} + 1.25$		+10	*		*	*		*	V
Ref Low Input Voltage Range		0		$V_{REFH} - 1.25$	*		*	*		*	V
Ref High Input Current		-0.3		1.0		*			*	*	mA
Ref Low Input Current		-1.5		-0.3		*			*	*	mA
<b>DYNAMIC PERFORMANCE</b>											
Settling Time	To $\pm 0.003\%$ , 10V Output Step See Figure 6		8	10		*	*		*	*	$\mu s$
Channel-to-Channel Crosstalk			0.5			*			*	*	LSB
Digital Feedthrough			2			*			*	*	nV-s
Output Noise Voltage	$f = 10kHz$		60			*			*	*	$nV/\sqrt{Hz}$
<b>DIGITAL INPUT</b>											
$V_{IH}$		$0.7 \cdot V_{DD}$		$V_{DD}$	*			*		*	V
$V_{IL}$		0		$0.3 \cdot V_{DD}$			*		*	*	V
$I_{IH}$				$\pm 10$			*		*	*	$\mu A$
$I_{IL}$				$\pm 10$			*		*	*	$\mu A$
<b>DIGITAL OUTPUT</b>											
$V_{OH}$	$I_{OH} = -0.8mA$	3.6	4.5		*	*		*	*	*	V
$V_{OL}$	$I_{OL} = 1.6mA$		0.3	0.4		*	*		*	*	V
<b>POWER SUPPLY</b>											
$V_{DD}$		+4.75	+5.0	+5.25	*	*	*	*	*	*	V
$V_{CC}$		+14.25	+15.0	+15.75	*	*	*	*	*	*	V
$V_{SS}$			0			*			*	*	V
$I_{DD}$			50			*			*	*	$\mu A$
$I_{CC}$			3.5			*			*	*	mA
Power			50	70		*			*	*	mW
<b>TEMPERATURE RANGE</b>											
Specified Performance		-40		+85	*		*	*		*	$^\circ C$

\* Specifications same as grade to the left.

NOTE: (1) If  $V_{SS} = 0V$ , the specification applies at code 0021<sub>H</sub> and above, due to possible negative zero scale error.

## ABSOLUTE MAXIMUM RATINGS<sup>(1)</sup>

$V_{CC}$ to $V_{SS}$ .....	-0.3V to +32V
$V_{CC}$ to AGND .....	-0.3V to +16V
$V_{SS}$ to AGND .....	+0.3V to -16V
AGND to DGND .....	-0.3V to +0.3V
$V_{REFH}$ to AGND .....	-9V to +11V
$V_{REFL}$ to AGND .....	-11V to +9V
$V_{DD}$ to GND .....	-0.3V to +6V
$V_{REFH}$ to $V_{REFL}$ .....	-1V to 22V
Digital Input Voltage to GND .....	-0.3V to $V_{DD} + 0.3V$
Digital Output Voltage to GND .....	-0.3V to $V_{DD} + 0.3V$
Maximum Junction Temperature .....	+150°C
Operating Temperature Range .....	-40°C to +85°C
Storage Temperature Range .....	-65°C to +150°C
Lead Temperature (soldering, 10s) .....	+300°C

NOTE: (1) Stresses above those listed under "Absolute Maximum Ratings" may cause permanent damage to the device. Exposure to absolute maximum conditions for extended periods may affect device reliability.



## ELECTROSTATIC DISCHARGE SENSITIVITY

This integrated circuit can be damaged by ESD. Burr-Brown recommends that all integrated circuits be handled with appropriate precautions. Failure to observe proper handling and installation procedures can cause damage.

ESD damage can range from subtle performance degradation to complete device failure. Precision integrated circuits may be more susceptible to damage because very small parametric changes could cause the device not to meet its published specifications.

## PACKAGE/ORDERING INFORMATION

PRODUCT	LINEARITY ERROR (LSB)	DIFFERENTIAL NONLINEARITY (LSB)	PACKAGE	PACKAGE DRAWING NUMBER	SPECIFICATION TEMPERATURE RANGE	ORDERING NUMBER <sup>(1)</sup>	TRANSPORT MEDIA
DAC7744E	±4	±3	48-Lead SSOP	333	-40°C to +85°C	DAC7744E	Rails
"	"	"	"	"	"	DAC7744E/1K	Tape and Reel
DAC7744EB	±4	±2	48-Lead SSOP	333	-40°C to +85°C	DAC7744EB	Rails
"	"	"	"	"	"	DAC7744EB/1K	Tape and Reel
DAC7744EC	±3	±1	48-Lead SSOP	333	-40°C to +85°C	DAC7744EC	Rails
"	"	"	"	"	"	DAC7744EC/1K	Tape and Reel

NOTE: (1) Models with a slash (/) are available only in Tape and Reel in the quantities indicated (e.g., /1K indicates 1000 devices per reel). Ordering 1000 pieces of "DAC7744E/1K" will get a single 1000-piece Tape and Reel.

## ESD PROTECTION CIRCUITS

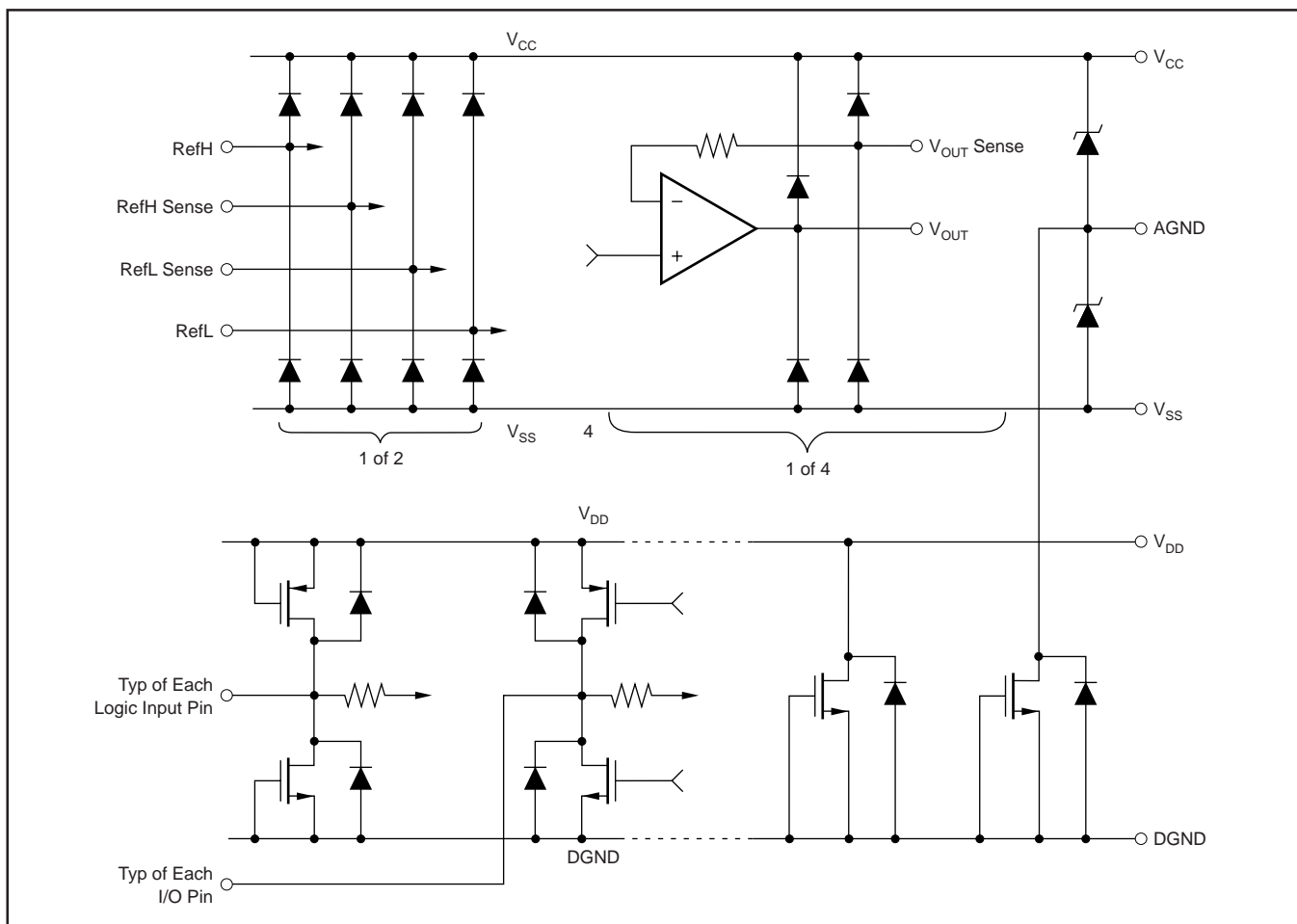



# TYPICAL PERFORMANCE CURVES: $V_{SS} = 0V$

At  $T_A = +25^\circ C$ ,  $V_{DD} = +5V$ ,  $V_{CC} = +15V$ ,  $V_{SS} = 0$ ,  $V_{REFH} = +10V$ , and  $V_{REFL} = 0V$ , representative unit, unless otherwise specified.

## +25°C

LINEARITY ERROR AND  
DIFFERENTIAL LINEARITY ERROR vs CODE  
(DAC A, +25°C)

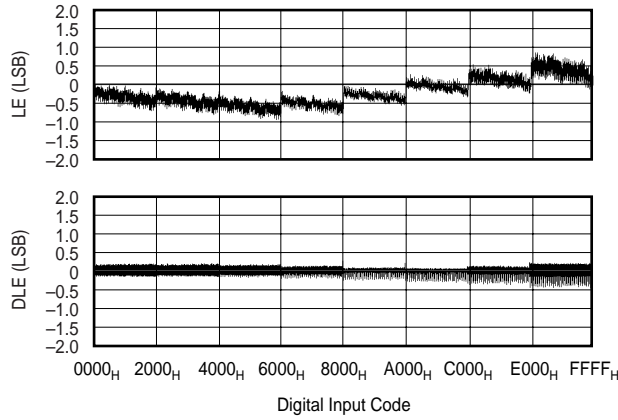

LINEARITY ERROR AND  
DIFFERENTIAL LINEARITY ERROR vs CODE  
(DAC B, +25°C)

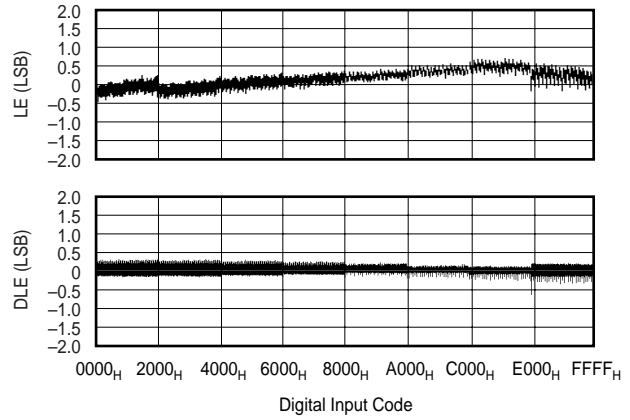

LINEARITY ERROR AND  
DIFFERENTIAL LINEARITY ERROR vs CODE  
(DAC C, +25°C)

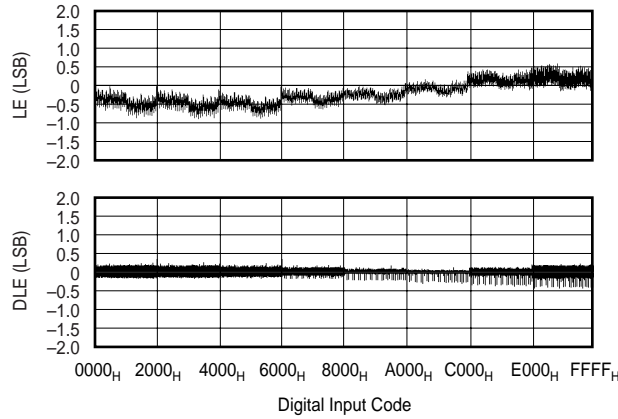

LINEARITY ERROR AND  
DIFFERENTIAL LINEARITY ERROR vs CODE  
(DAC D, +25°C)

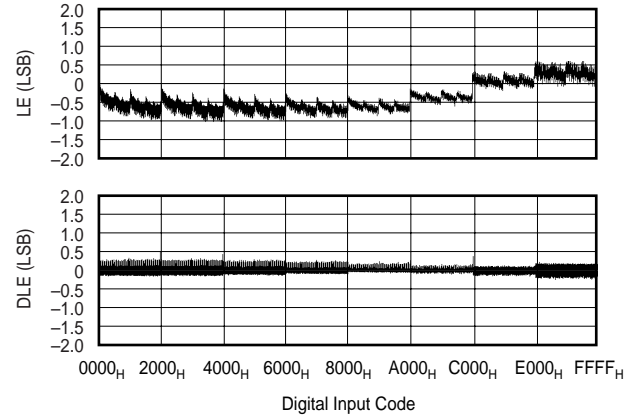

## +85°C

LINEARITY ERROR AND  
DIFFERENTIAL LINEARITY ERROR vs CODE  
(DAC A, +85°C)

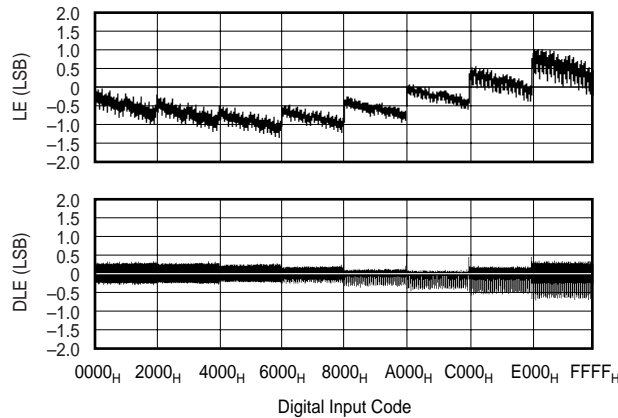

LINEARITY ERROR AND  
DIFFERENTIAL LINEARITY ERROR vs CODE  
(DAC B, +85°C)

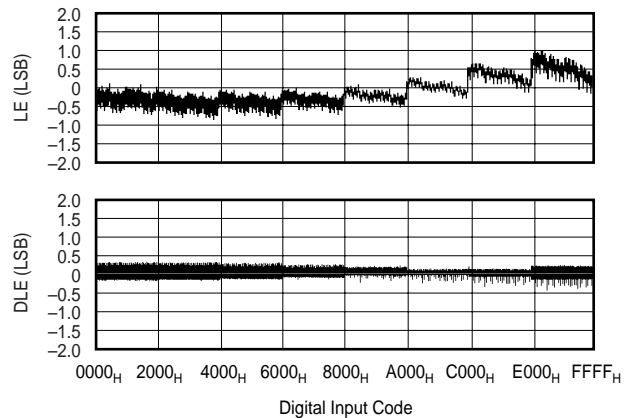

# TYPICAL PERFORMANCE CURVES: $V_{SS} = 0V$ (Cont.)

At  $T_A = +25^\circ C$ ,  $V_{DD} = +5V$ ,  $V_{CC} = +15V$ ,  $V_{SS} = 0$ ,  $V_{REFH} = +10V$ , and  $V_{REFL} = 0V$ , representative unit, unless otherwise specified.

## +85°C (cont.)

LINEARITY ERROR AND  
DIFFERENTIAL LINEARITY ERROR vs CODE  
(DAC C, +85°C)

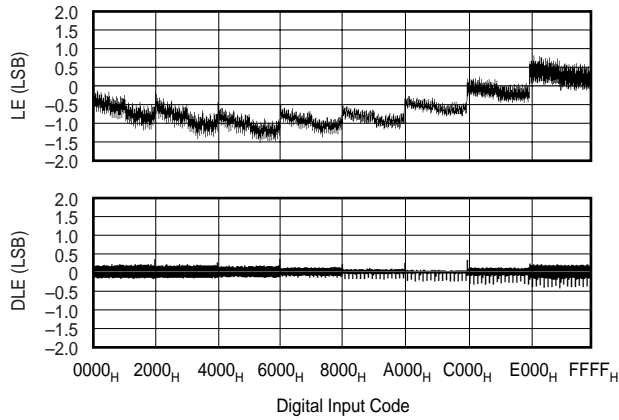

LINEARITY ERROR AND  
DIFFERENTIAL LINEARITY ERROR vs CODE  
(DAC D, +85°C)

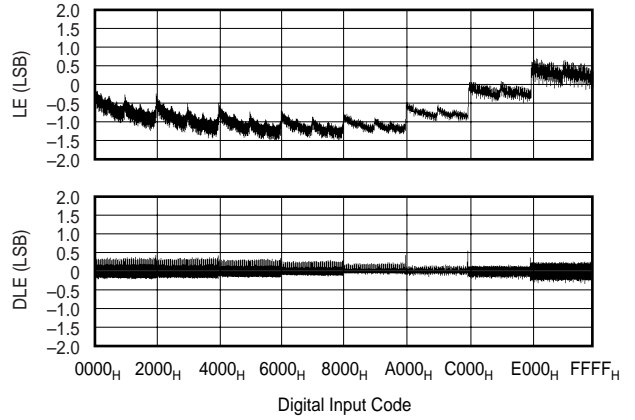

## -40°C

LINEARITY ERROR AND  
DIFFERENTIAL LINEARITY ERROR vs CODE  
(DAC A, -40°C)

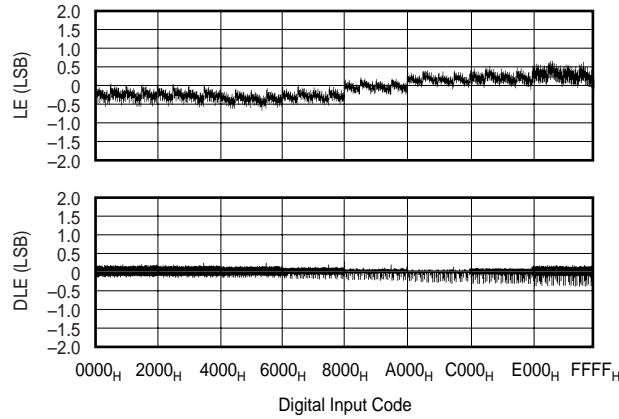

LINEARITY ERROR AND  
DIFFERENTIAL LINEARITY ERROR vs CODE  
(DAC B, -40°C)

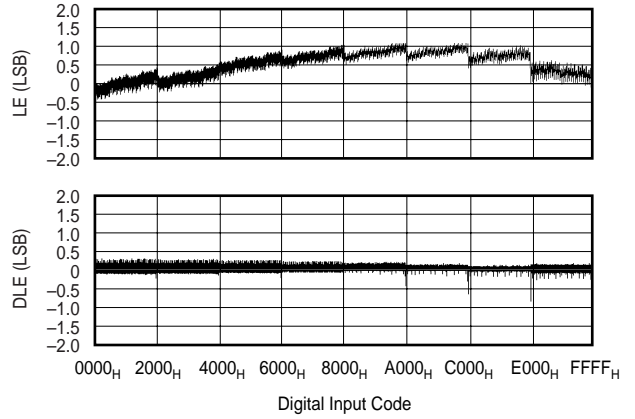

LINEARITY ERROR AND  
DIFFERENTIAL LINEARITY ERROR vs CODE  
(DAC C, -40°C)

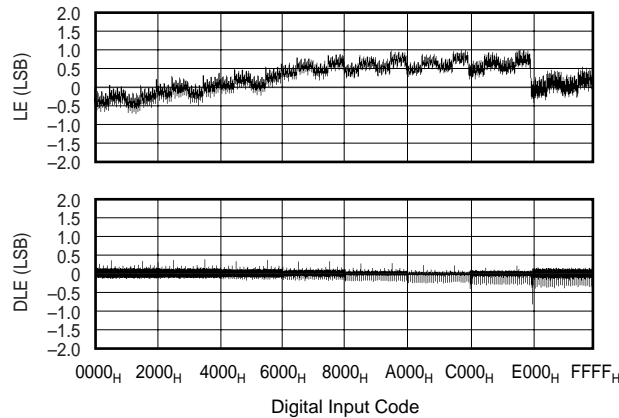

LINEARITY ERROR AND  
DIFFERENTIAL LINEARITY ERROR vs CODE  
(DAC D, -40°C)

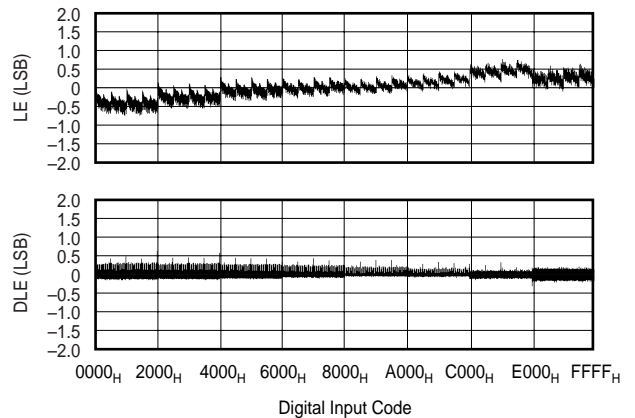

# TYPICAL PERFORMANCE CURVES: $V_{SS} = 0V$ (Cont.)

At  $T_A = +25^\circ C$ ,  $V_{DD} = +5V$ ,  $V_{CC} = +15V$ ,  $V_{SS} = 0$ ,  $V_{REFH} = +10V$ , and  $V_{REFL} = 0V$ , representative unit, unless otherwise specified.

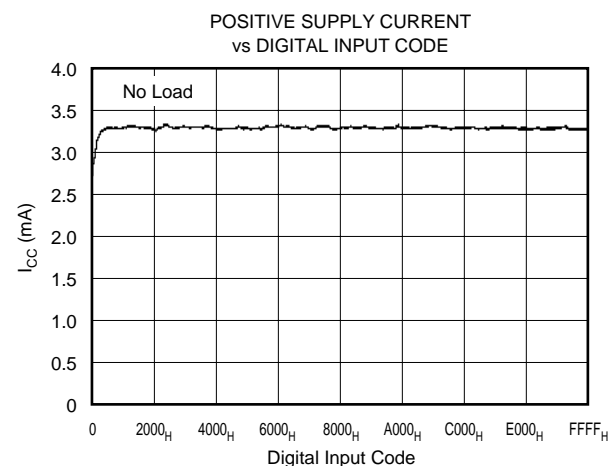
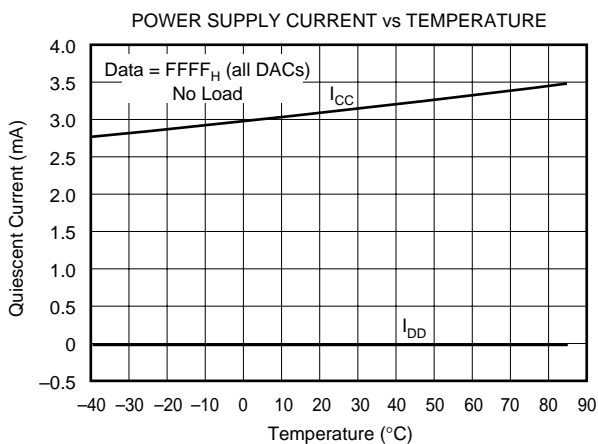
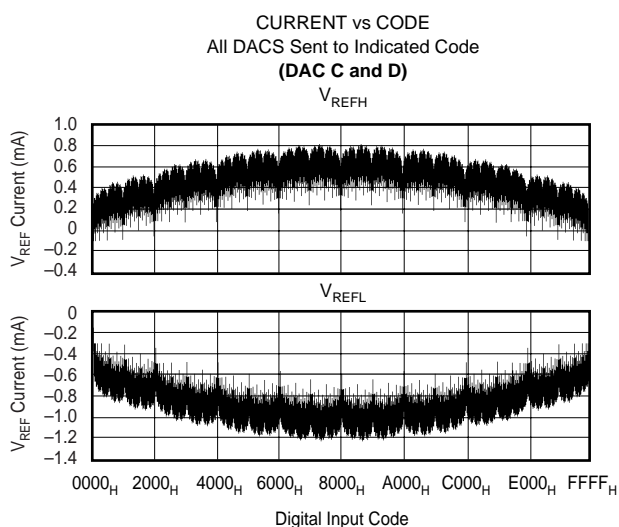
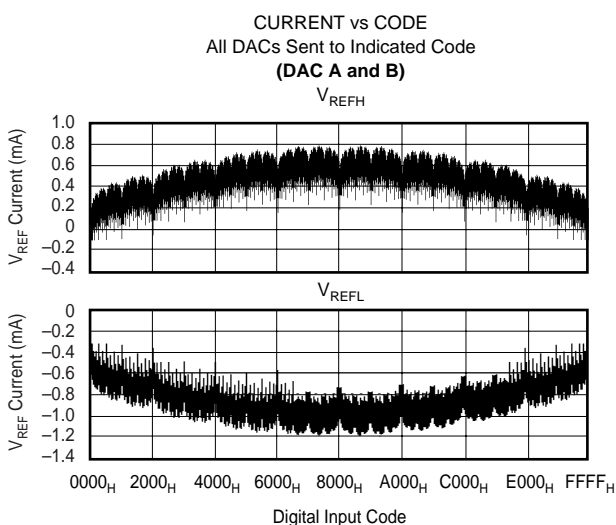
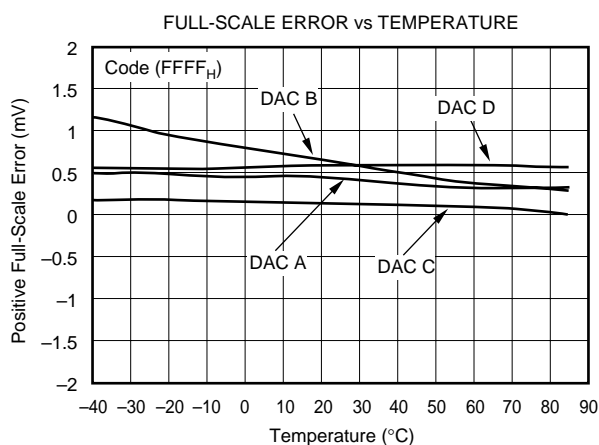
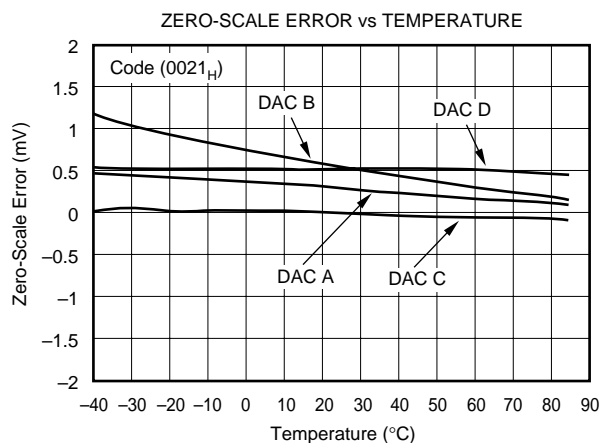

# TYPICAL PERFORMANCE CURVES: $V_{SS} = 0V$ (Cont.)

At  $T_A = +25^\circ C$ ,  $V_{DD} = +5V$ ,  $V_{CC} = +15V$ ,  $V_{SS} = 0$ ,  $V_{REFH} = +10V$ , and  $V_{REFL} = 0V$ , representative unit, unless otherwise specified.

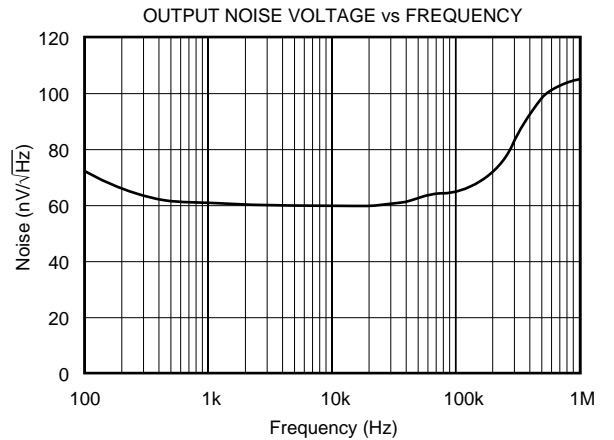
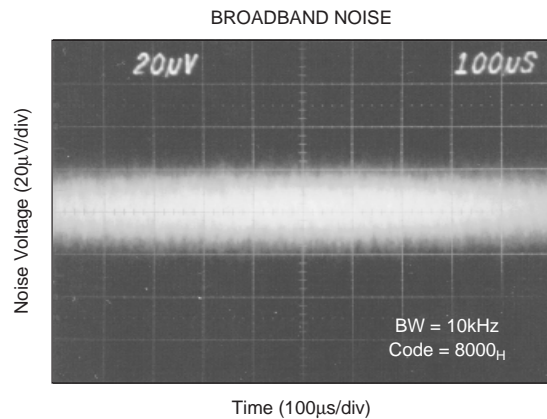
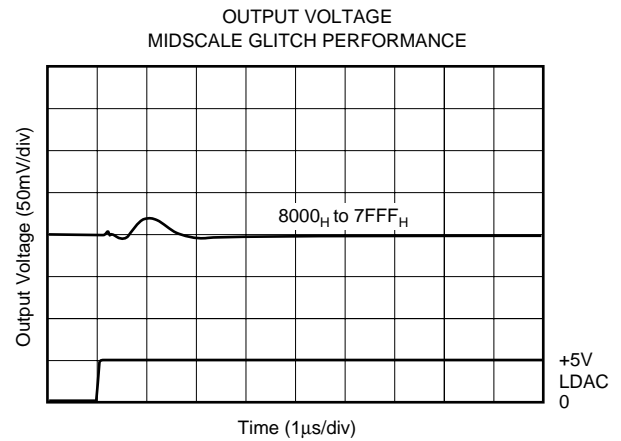
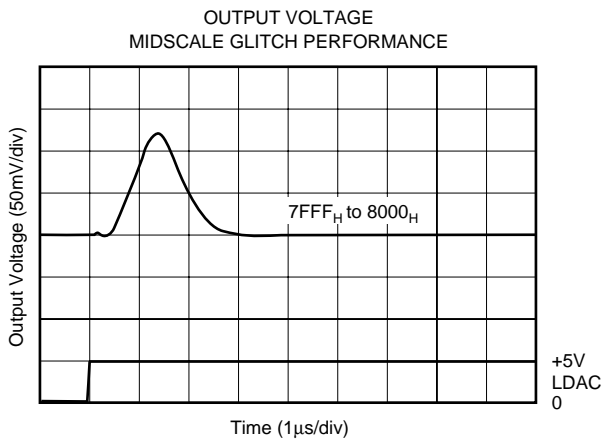
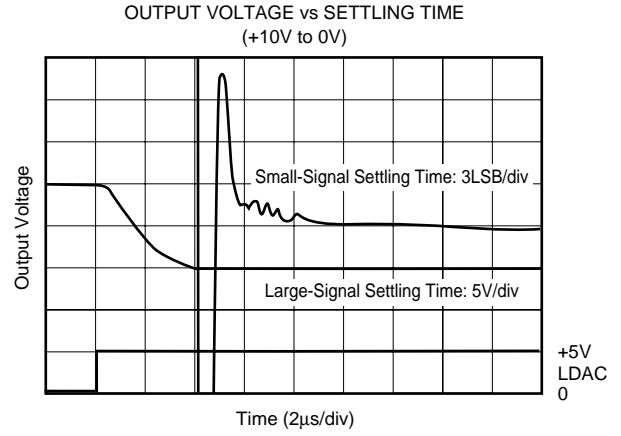
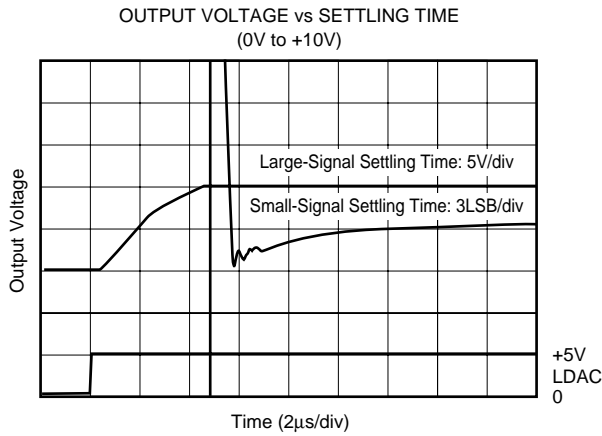

# TYPICAL PERFORMANCE CURVES: $V_{SS} = 0V$ (Cont.)

At  $T_A = +25^\circ C$ ,  $V_{DD} = +5V$ ,  $V_{CC} = +15V$ ,  $V_{SS} = 0$ ,  $V_{REFH} = +10V$ , and  $V_{REFL} = 0V$ , representative unit, unless otherwise specified.

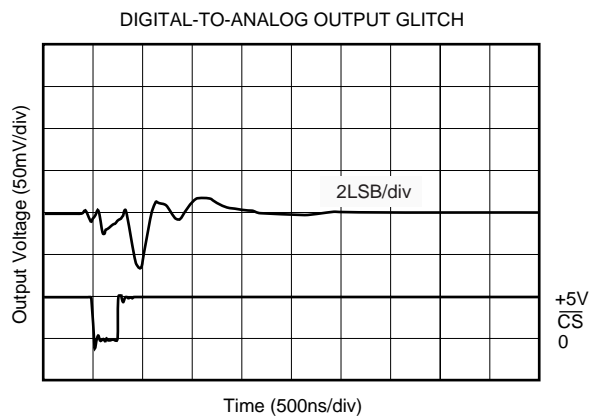
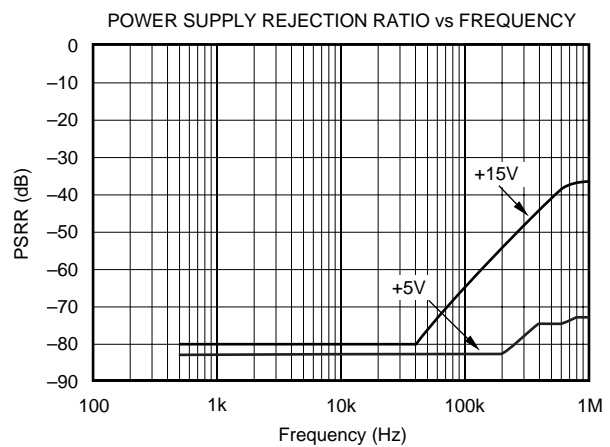
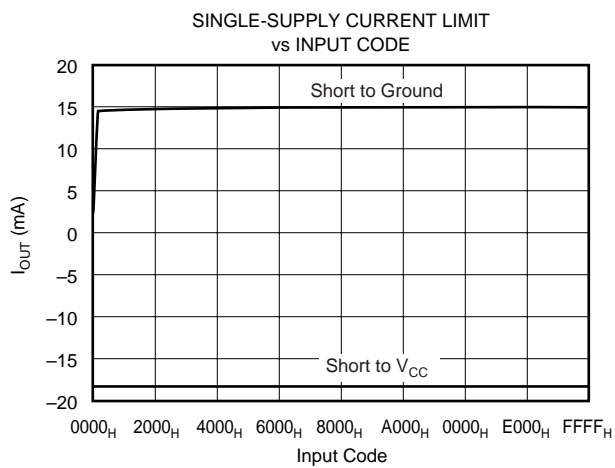
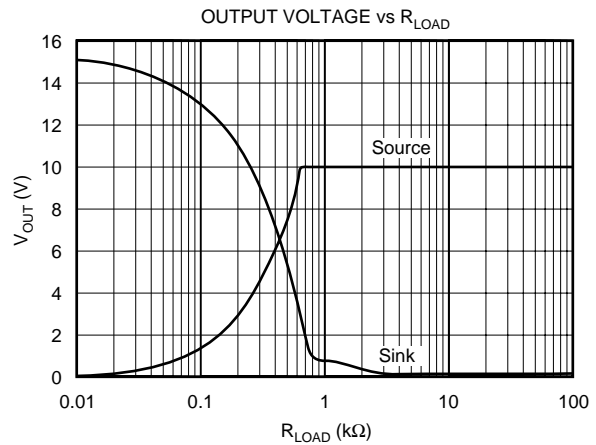
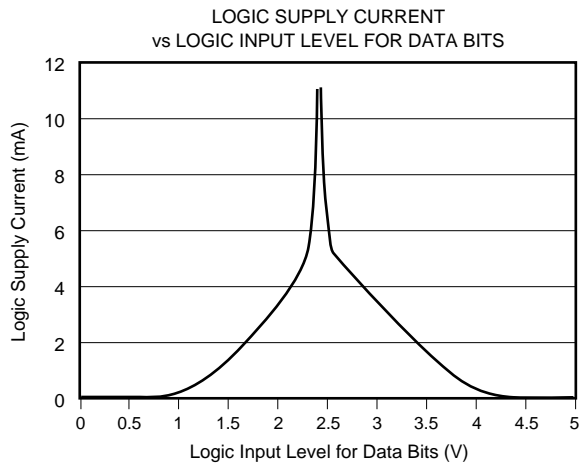

# TYPICAL PERFORMANCE CURVES: $V_{SS} = -15V$

At  $T_A = +25^\circ C$ ,  $V_{DD} = +5V$ ,  $V_{CC} = +15V$ ,  $V_{SS} = -15V$ ,  $V_{REFH} = +10V$ , and  $V_{REFL} = -10V$ , representative unit, unless otherwise specified.

## +25°C

LINEARITY ERROR AND  
DIFFERENTIAL LINEARITY ERROR vs CODE  
(DAC A, +25°C)

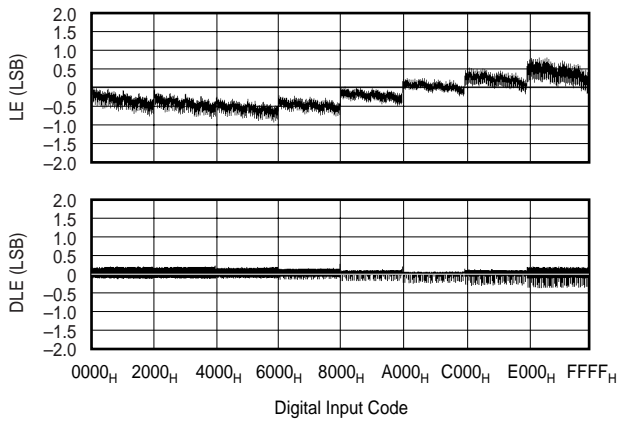

LINEARITY ERROR AND  
DIFFERENTIAL LINEARITY ERROR vs CODE  
(DAC B, +25°C)

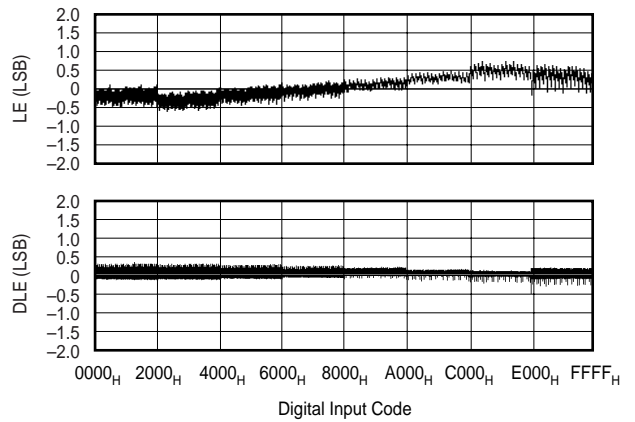

LINEARITY ERROR AND  
DIFFERENTIAL LINEARITY ERROR vs CODE  
(DAC C, +25°C)

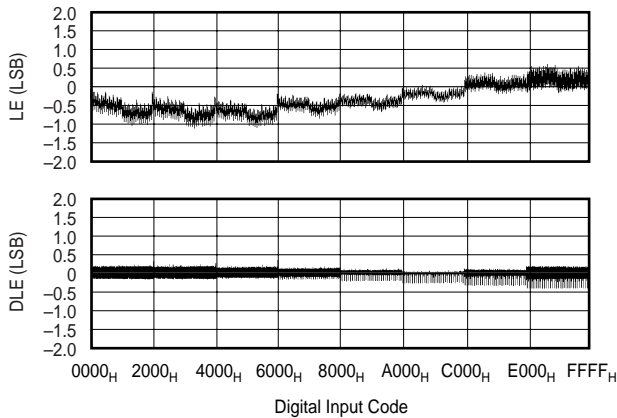

LINEARITY ERROR AND  
DIFFERENTIAL LINEARITY ERROR vs CODE  
(DAC D, +25°C)

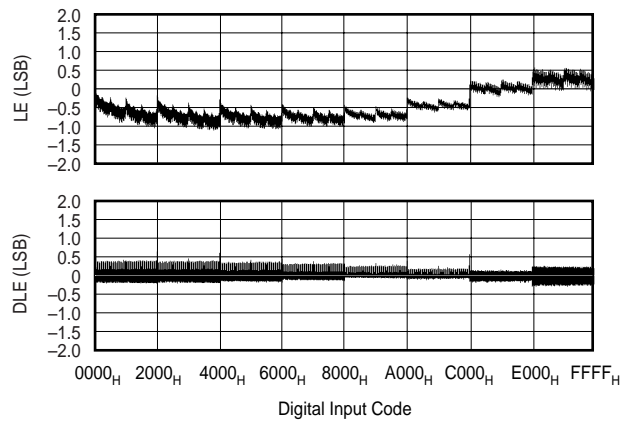

## +85°C

LINEARITY ERROR AND  
DIFFERENTIAL LINEARITY ERROR vs CODE  
(DAC A, +85°C)

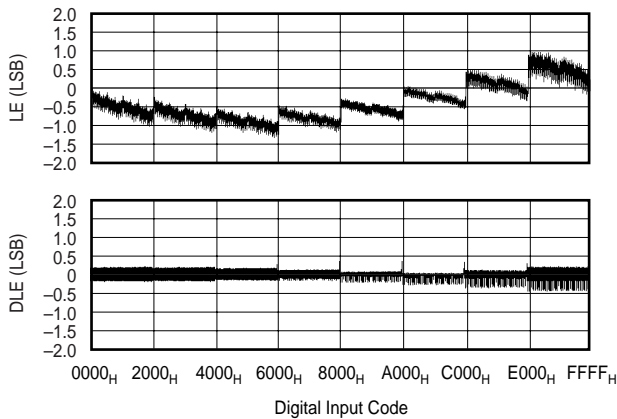

LINEARITY ERROR AND  
DIFFERENTIAL LINEARITY ERROR vs CODE  
(DAC B, +85°C)

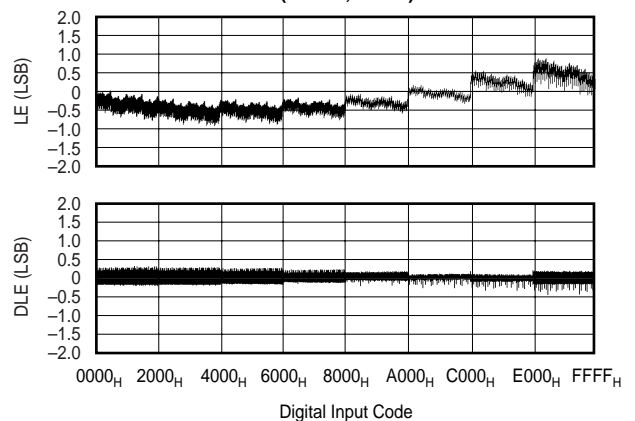

# TYPICAL PERFORMANCE CURVES: $V_{SS} = -15V$ (Cont.)

At  $T_A = +25^\circ C$ ,  $V_{DD} = +5V$ ,  $V_{CC} = +15V$ ,  $V_{SS} = -15V$ ,  $V_{REFH} = +10V$ , and  $V_{REFL} = -10V$ , representative unit, unless otherwise specified.

## +85°C (cont.)

LINEARITY ERROR AND  
DIFFERENTIAL LINEARITY ERROR vs CODE  
(DAC C, +85°C)

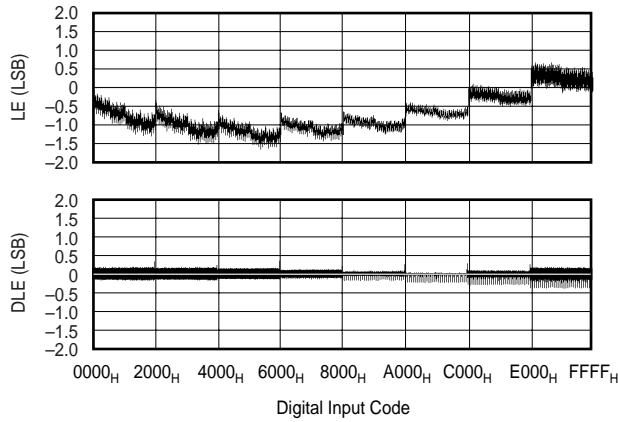

LINEARITY ERROR AND  
DIFFERENTIAL LINEARITY ERROR vs CODE  
(DAC D, +85°C)

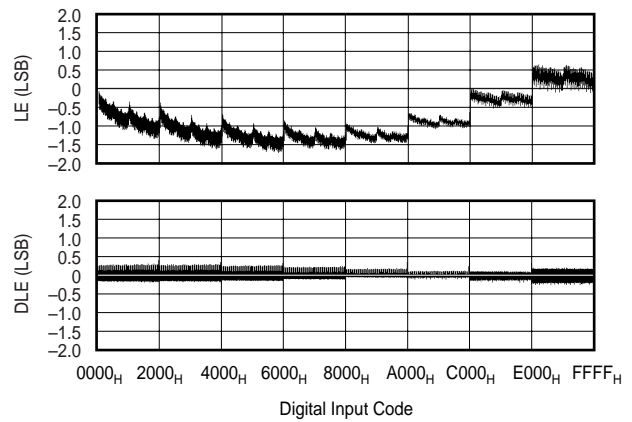

## -40°C

LINEARITY ERROR AND  
DIFFERENTIAL LINEARITY ERROR vs CODE  
(DAC A, -40°C)

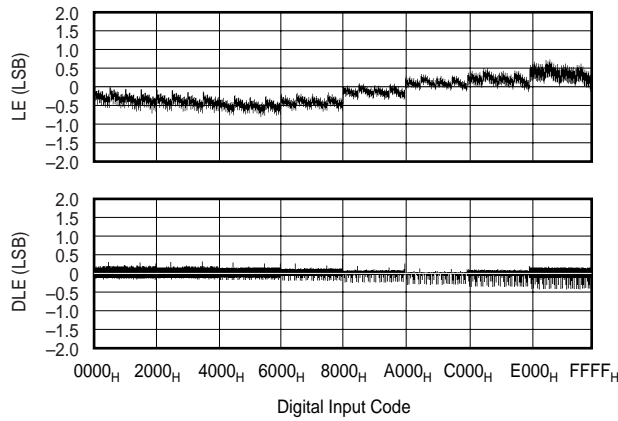

LINEARITY ERROR AND  
DIFFERENTIAL LINEARITY ERROR vs CODE  
(DAC B, -40°C)

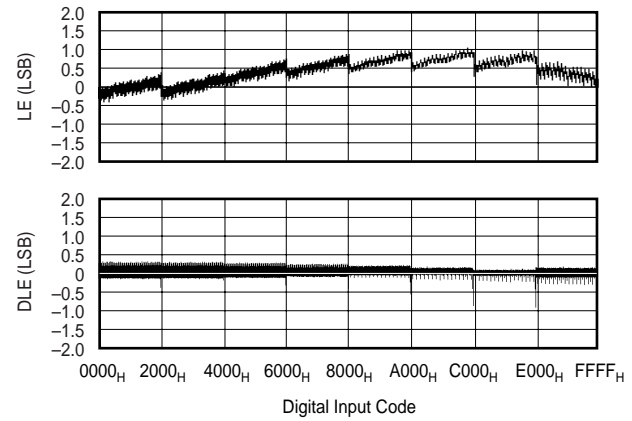

LINEARITY ERROR AND  
DIFFERENTIAL LINEARITY ERROR vs CODE  
(DAC C, -40°C)

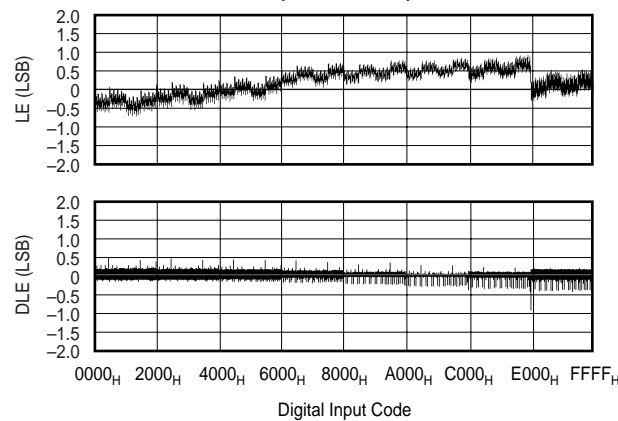

LINEARITY ERROR AND  
DIFFERENTIAL LINEARITY ERROR vs CODE  
(DAC D, -40°C)

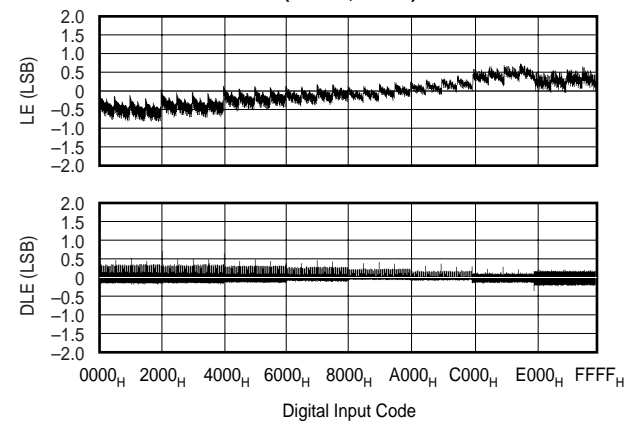

# TYPICAL PERFORMANCE CURVES: $V_{SS} = -15V$ (Cont.)

At  $T_A = +25^\circ C$ ,  $V_{DD} = +5V$ ,  $V_{CC} = +15V$ ,  $V_{SS} = -15V$ ,  $V_{REFH} = +10V$ , and  $V_{REFL} = -10V$ , representative unit, unless otherwise specified.

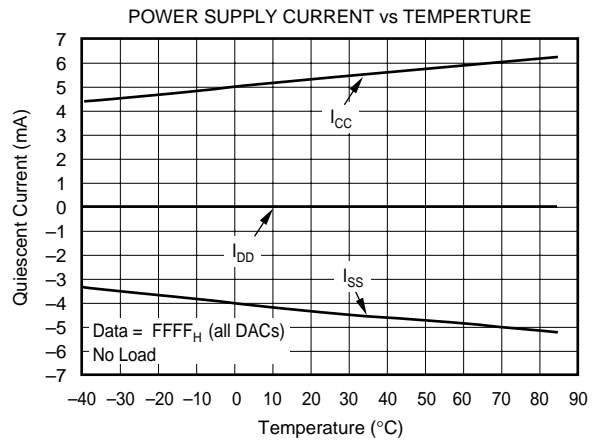
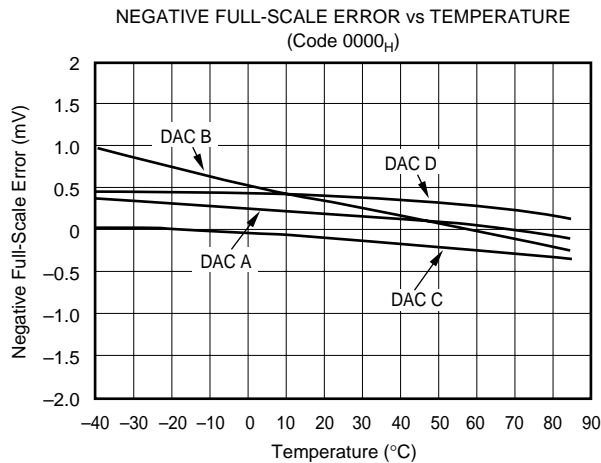
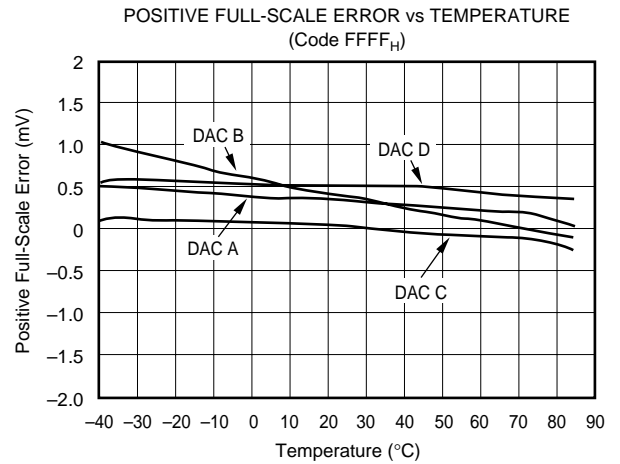
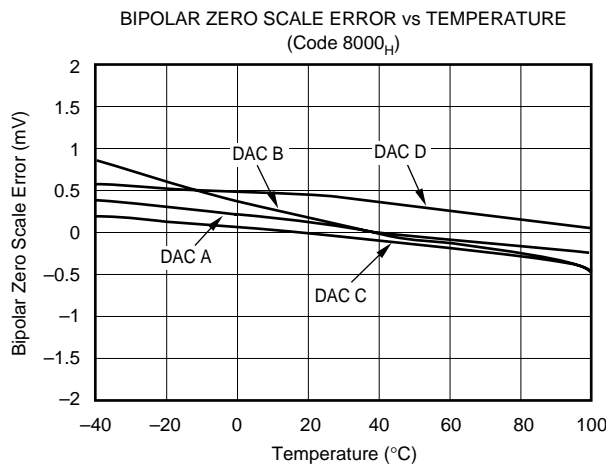
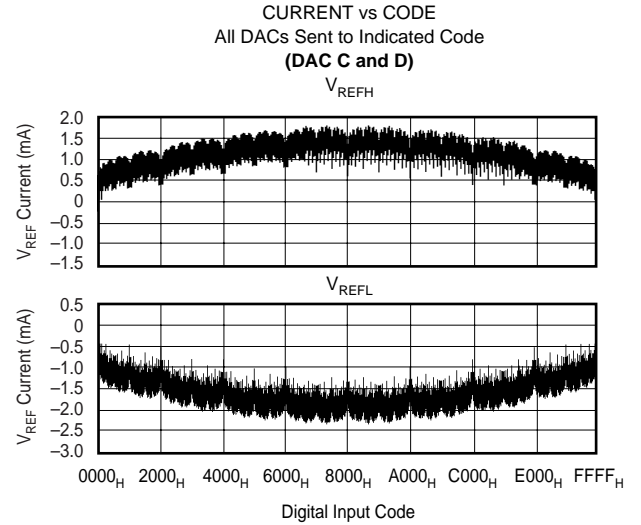
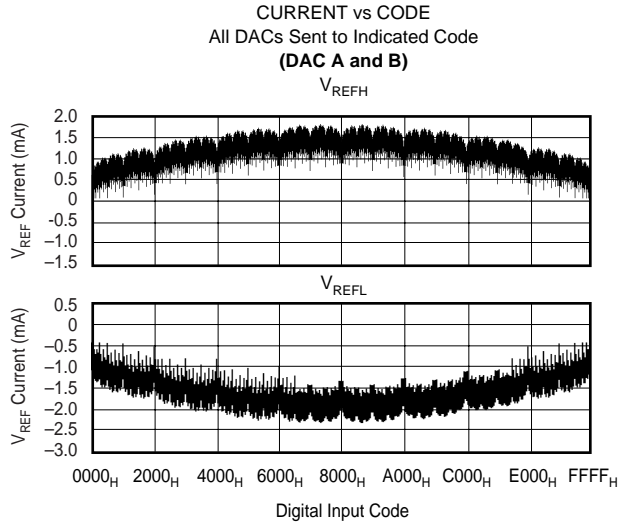

# TYPICAL PERFORMANCE CURVES: $V_{SS} = -15V$ (Cont.)

At  $T_A = +25^\circ C$ ,  $V_{DD} = +5V$ ,  $V_{CC} = +15V$ ,  $V_{SS} = -15V$ ,  $V_{REFH} = +10V$ , and  $V_{REFL} = -10V$ , representative unit, unless otherwise specified.

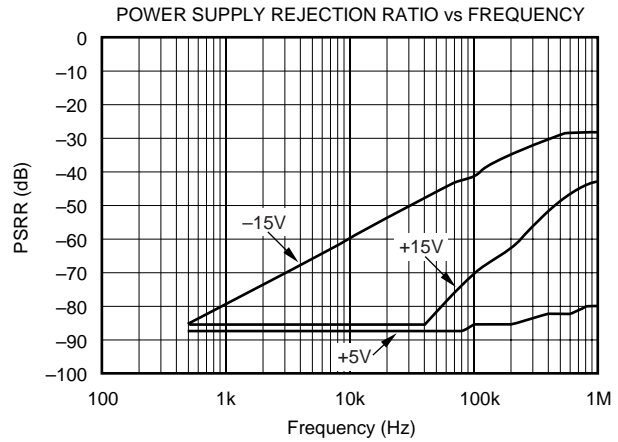
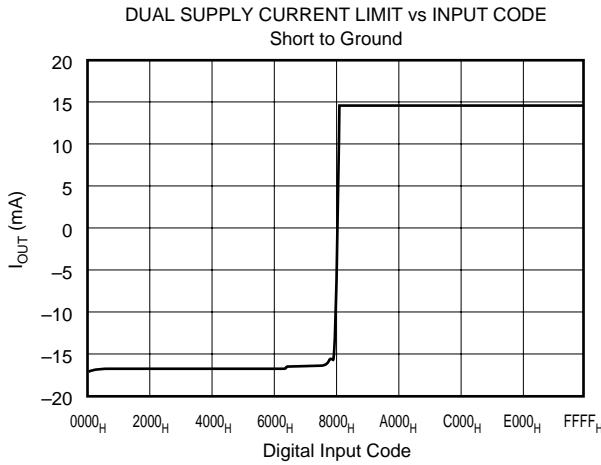
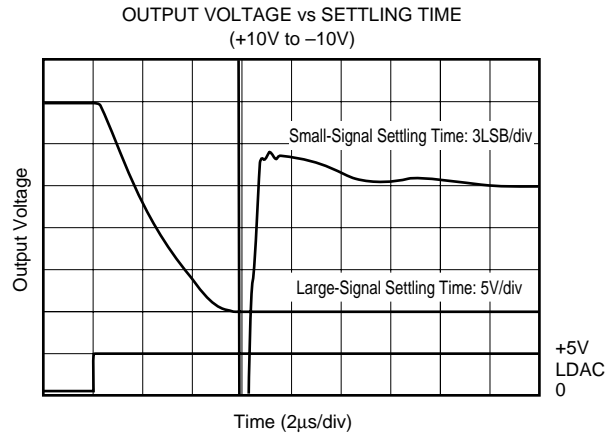
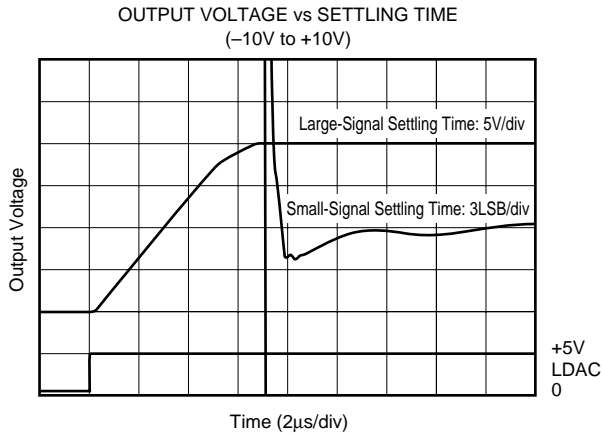
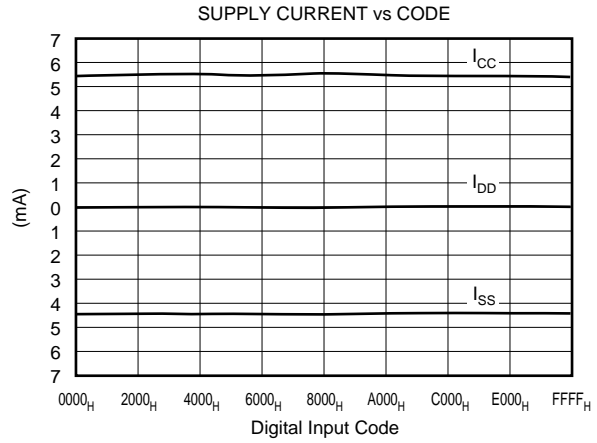
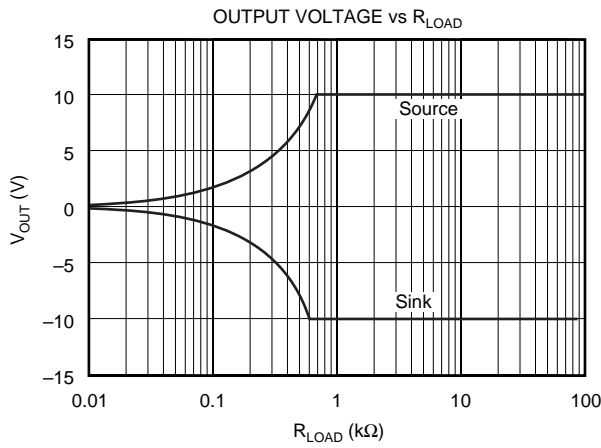

# TYPICAL PERFORMANCE CURVES: $V_{SS} = -15V$ (Cont.)

At  $T_A = +25^\circ C$ ,  $V_{DD} = +5V$ ,  $V_{CC} = +15V$ ,  $V_{SS} = -15V$ ,  $V_{REFH} = +10V$ , and  $V_{REFL} = -10V$ , representative unit, unless otherwise specified.

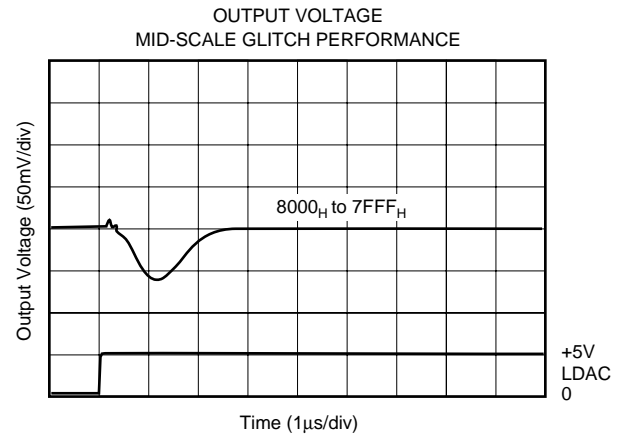
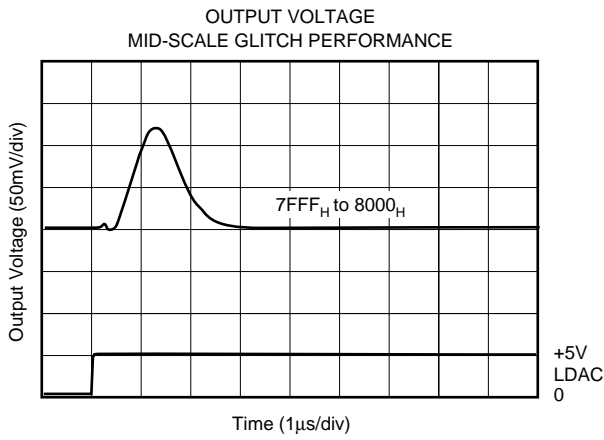

# THEORY OF OPERATION

The DAC7744 is a quad voltage output, 16-bit digital-to-analog converter (DAC). The architecture is an R-2R ladder configuration with the three MSB's segmented followed by an operational amplifier that serves as a buffer. Each DAC has its own R-2R ladder network, segmented MSBs and output op amp (see Figure 1). The minimum voltage output (zero scale) and maximum voltage output (full scale) are set

by the external voltage references ( $V_{REFL}$  and  $V_{REFH}$ , respectively). The digital input is a 16-bit parallel word and the DAC input registers offer a readback capability. The converters can be powered from either a single +15V supply or a dual  $\pm 15V$  supply. The device offers a reset function which immediately sets all DAC output voltages and DAC registers to mid-scale code 8000<sub>H</sub> or to zero scale, code 0000<sub>H</sub>. See Figures 2 and 3 for the basic operation of the DAC7744.

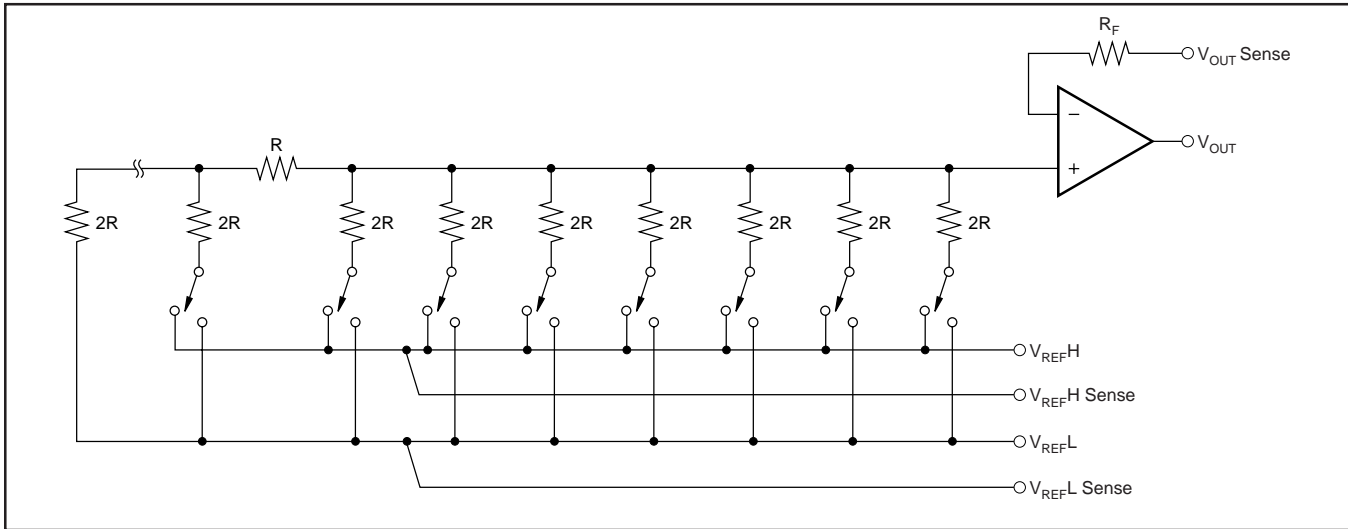

FIGURE 1. DAC7744 Architecture.

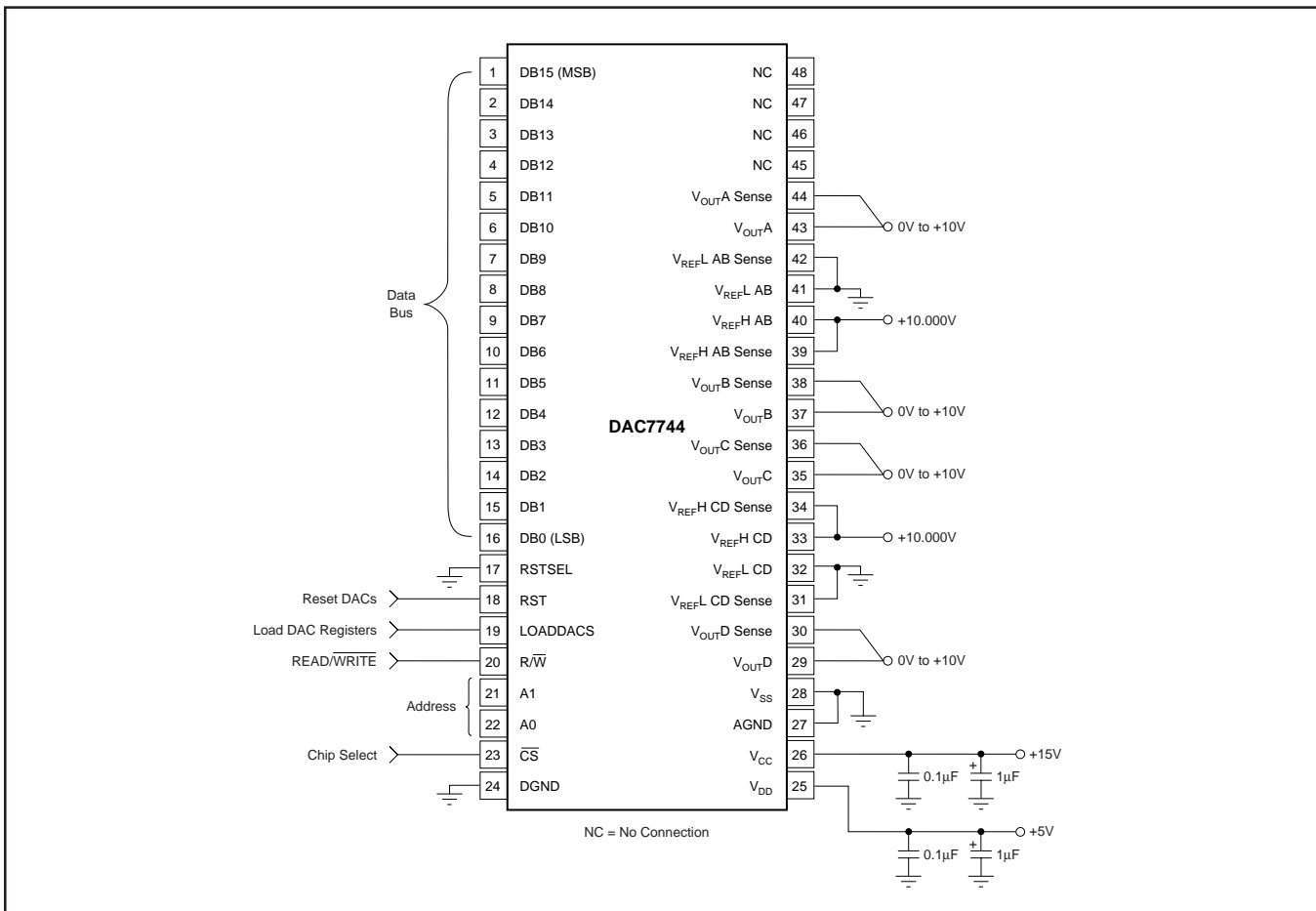

FIGURE 2. Basic Single-Supply Operation of the DAC7744.

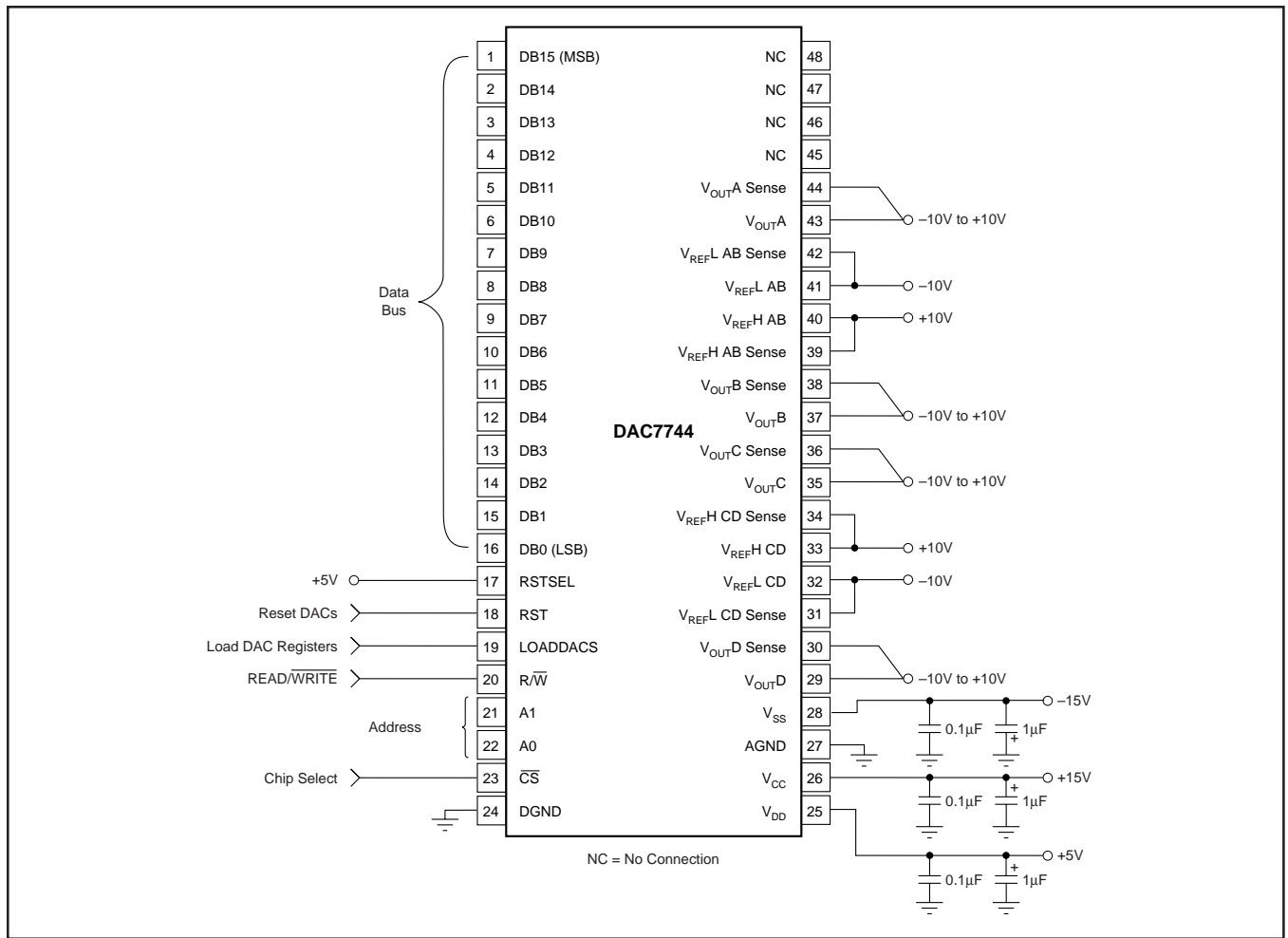

FIGURE 3. Basic Dual-Supply Operation of the DAC7744.

## ANALOG OUTPUTS

When  $V_{SS} = -15V$  (dual supply operation), the output amplifier can swing to within 4V of the supply rails, guaranteed over the  $-40^{\circ}C$  to  $+85^{\circ}C$  temperature range. With  $V_{SS} = 0V$  (single-supply operation), and with  $R_{LOAD}$  also connected to ground, the output can swing to ground. Care must also be taken when measuring the zero-scale error when  $V_{SS} = 0V$ . Since the output voltage cannot swing below ground, the output voltage may not change for the first few digital input codes (0000<sub>H</sub>, 0001<sub>H</sub>, 0002<sub>H</sub>, etc.), if the output amplifier has a negative offset. At the negative limit of  $-5mV$ , the first specified output starts at code 0021<sub>H</sub>.

Due to the high accuracy of these D/A converters, system design problems such as grounding and contact resistance become very important. A 16-bit converter with a 10V full-scale range has a 1LSB value of  $152\mu V$ . With a load current of 1mA, series wiring and connector resistance of only  $150m\Omega$  ( $R_{W2}$ ) will cause a voltage drop of  $150\mu V$ , as shown in Figure 4. To understand what this means in terms of a system layout, the resistivity of a typical 1 ounce copper-clad printed circuit board is  $1/2 m\Omega$  per square. For a 1mA load, a 20 milli-inch wide printed circuit conductor 6 inches long will result in a voltage drop of  $150\mu V$ .

The DAC7744 offers a force and sense output configuration for the high open-loop gain output amplifiers. This feature

allows the loop around the output amplifier to be closed at the load, thus ensuring an accurate output voltage, as shown in Figure 4.

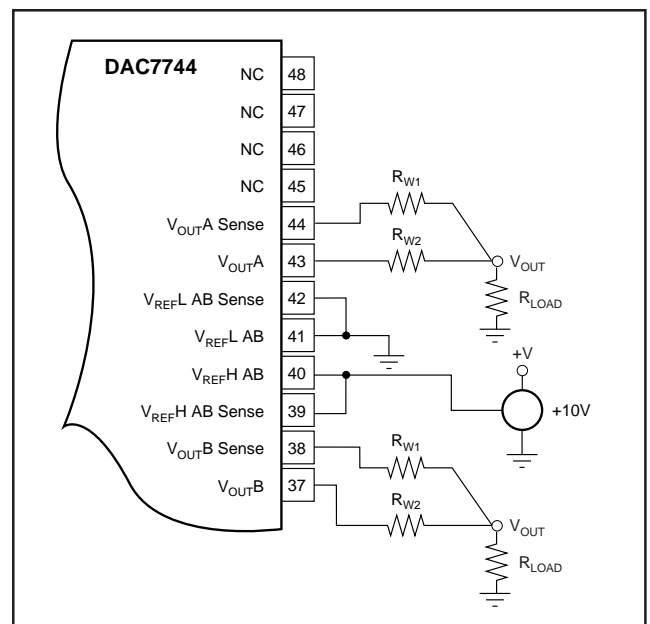

FIGURE 4. Analog Output Closed-Loop Configuration (1/2 DAC7744).  $R_W$  represents wiring resistances.

## REFERENCE INPUTS

The reference inputs,  $V_{REFL}$  and  $V_{REFH}$ , can be any voltage between  $V_{SS} + 4V$  and  $V_{CC} - 4V$ , provided that  $V_{REFH}$  is at least 1.25V greater than  $V_{REFL}$ . The minimum output of each DAC is equal to  $V_{REFL}$  plus a small offset voltage (essentially, the offset of the output op amp). The maximum output is equal to  $V_{REFH}$  plus a similar offset voltage. Note that  $V_{SS}$  (the negative power supply) must either be connected to ground or must be in the range of  $-14.25V$  to  $-15.75V$ . The voltage on  $V_{SS}$  sets several bias points within the converter. If  $V_{SS}$  is not in one of these two configurations, the bias values may be in error and proper operation of the device is not guaranteed.

The current into the  $V_{REFH}$  input and out of  $V_{REFL}$  depends on the DAC output voltages and can vary from a few

microamps to approximately 2.0mA. The reference input appears as a varying load to the reference. If the reference can sink or source the required current, a reference buffer is not required. The DAC7744 features a reference drive and sense connection such that the internal errors caused by the changing reference current and the circuit impedances can be minimized. Figures 5 through 12 show different reference configurations and the effect on the linearity and differential linearity.

The analog supplies (or the analog supplies and the reference power supplies) have to come up first. If the power supplies for the reference come up first, then the  $V_{CC}$  and  $V_{SS}$  supplies will be “powered from the reference via the ESD protection diode”, see page 4.

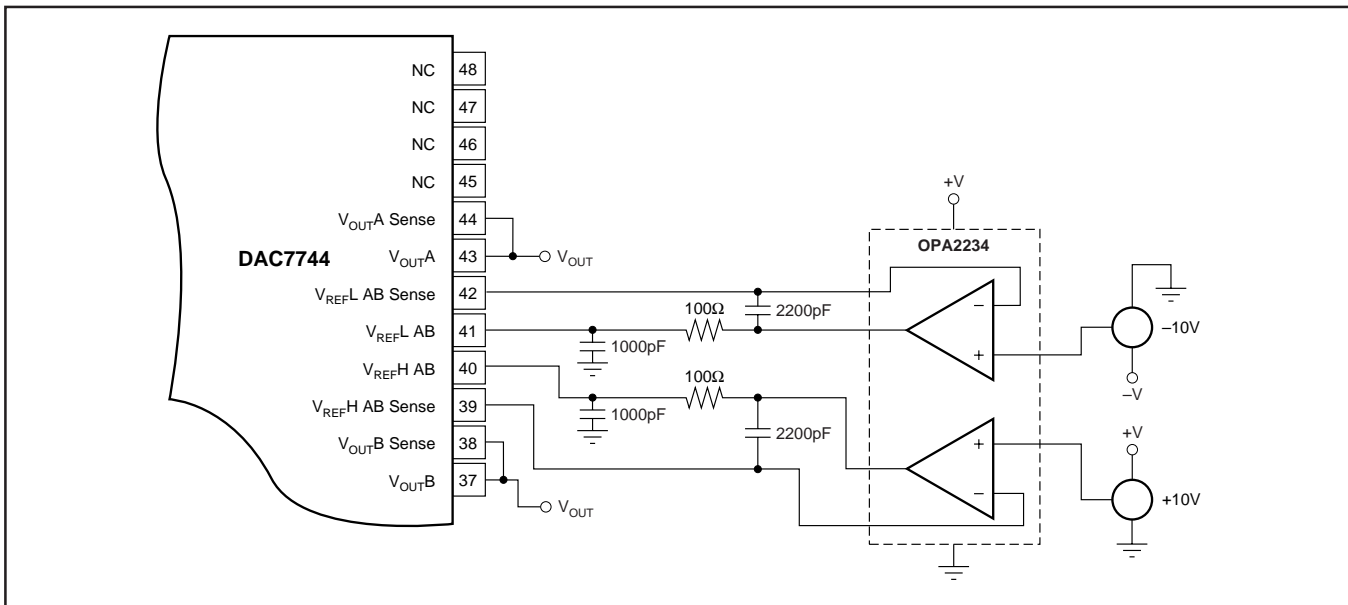

FIGURE 5. Dual Supply Configuration-Buffered References, used for Dual Supply Performance Curves (1/2 DAC7744).

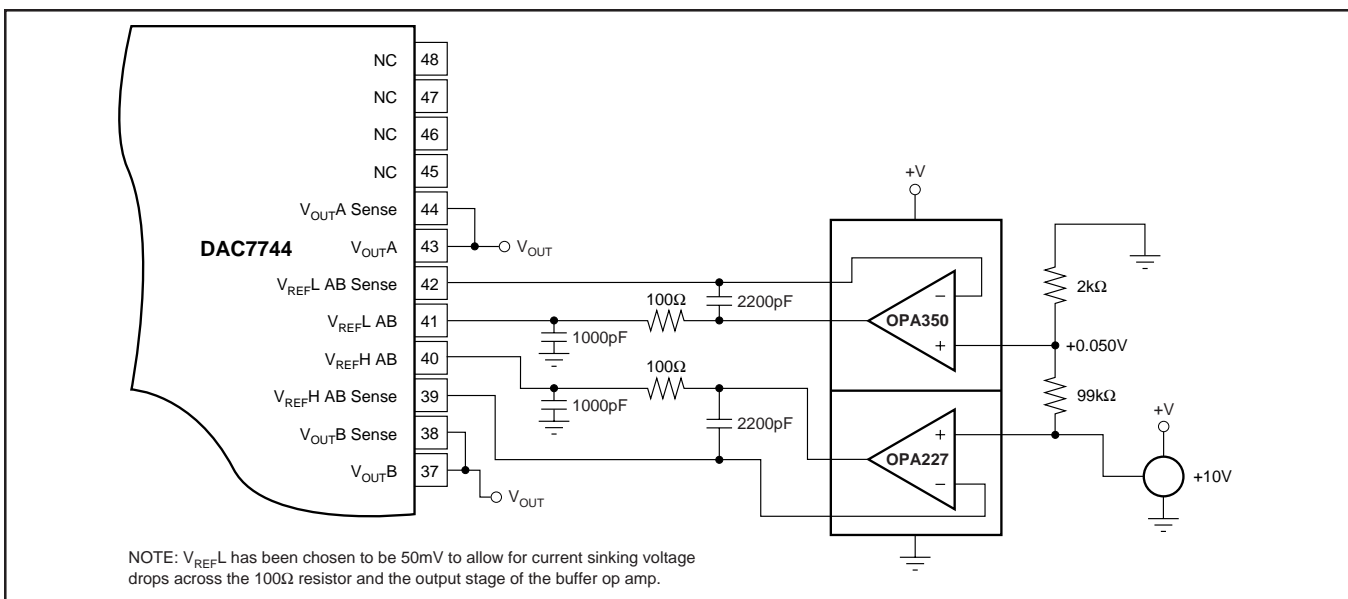

FIGURE 6. Single-Supply Buffered Reference with a Reference Low of 50mV Used for Single-Supply Performance Curves (1/2 DAC7744).

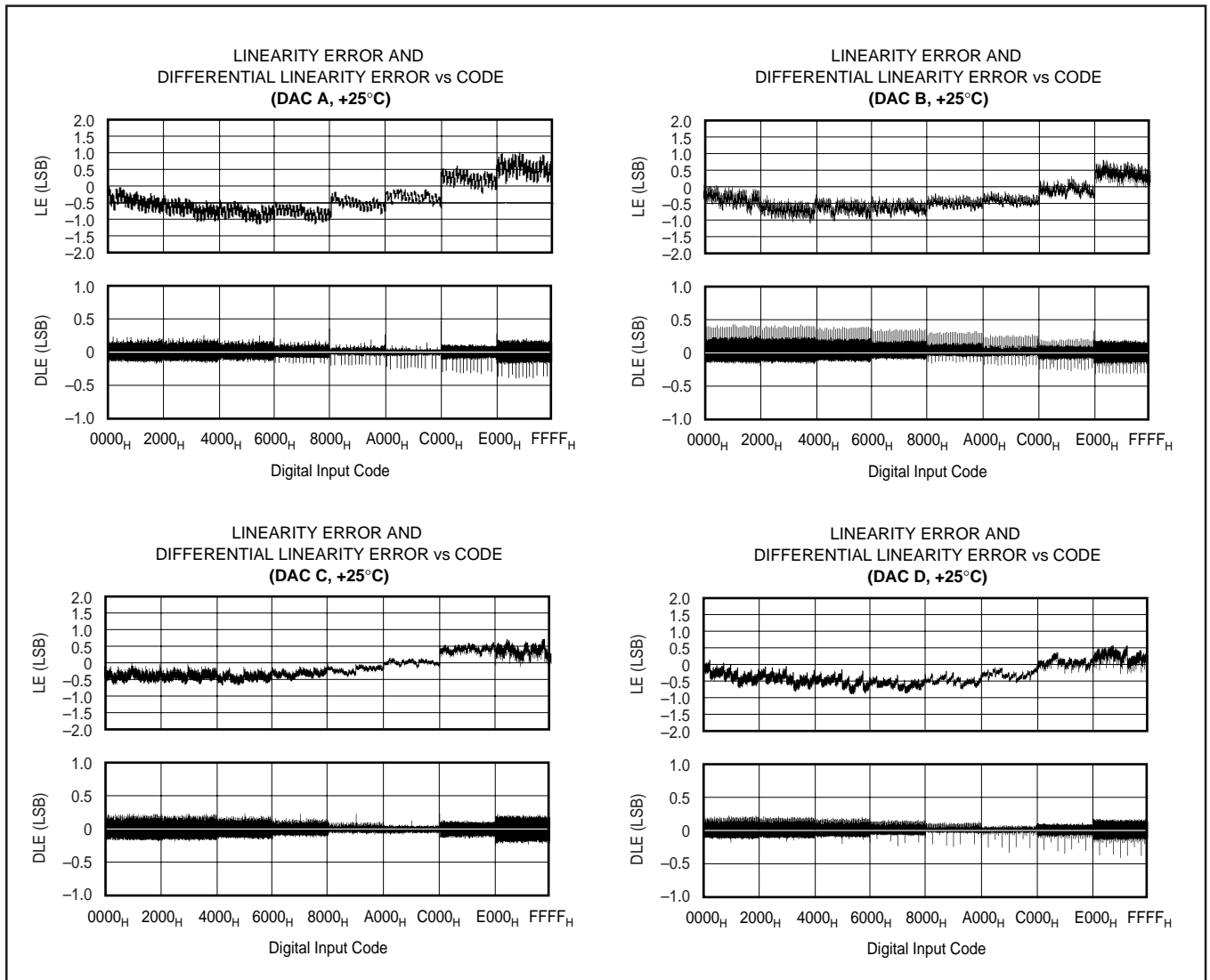

FIGURE 7. Integral Linearity and Differential Linearity Error Curves for Figure 8.

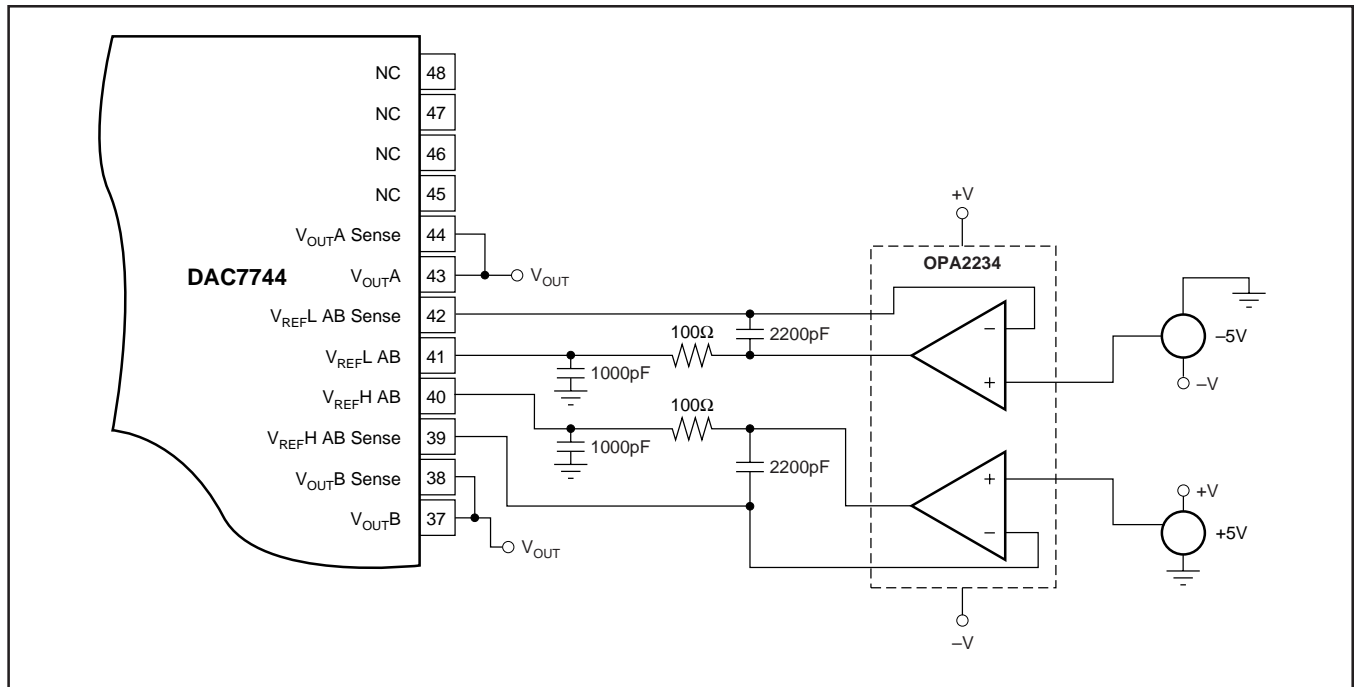

FIGURE 8. Dual-Supply Buffered Referenced with  $V_{REFL} = -5V$  and  $V_{REFH} = +5V$  (1/2 DAC7744).

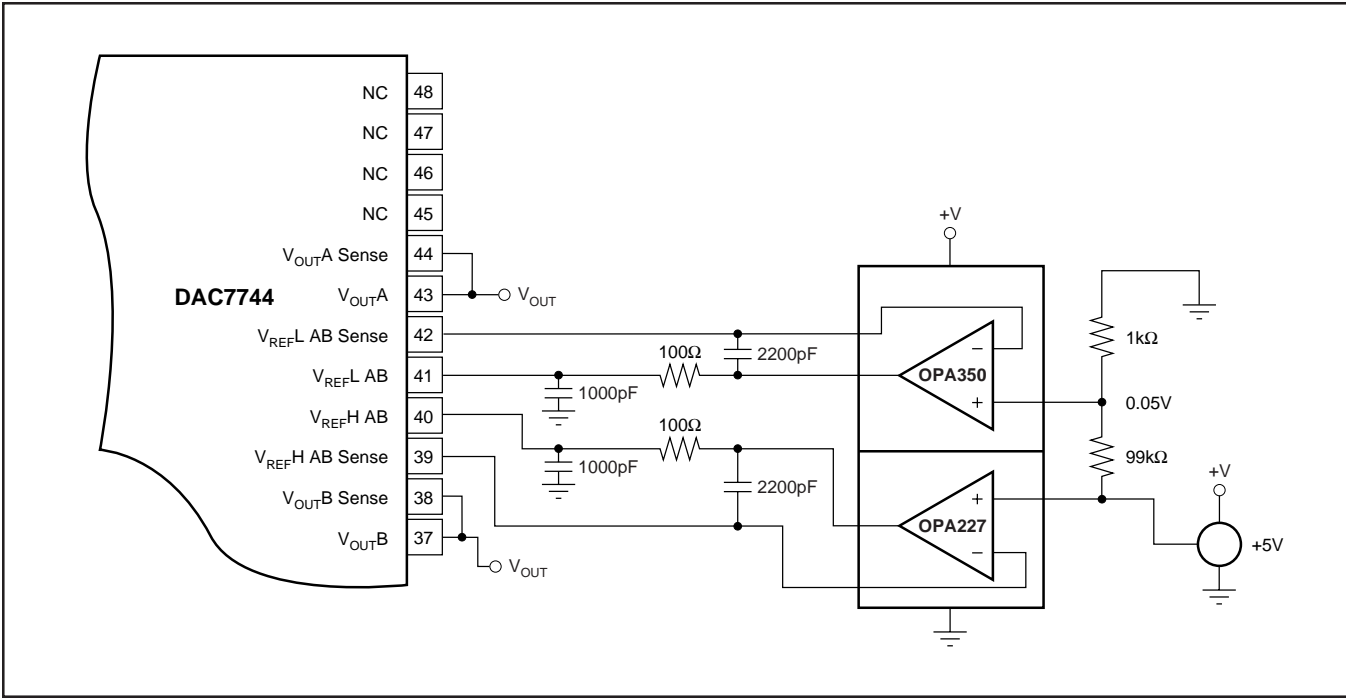

FIGURE 9. Single-Supply Buffered Reference with a Reference Low of 50mV and Reference High of +5V.

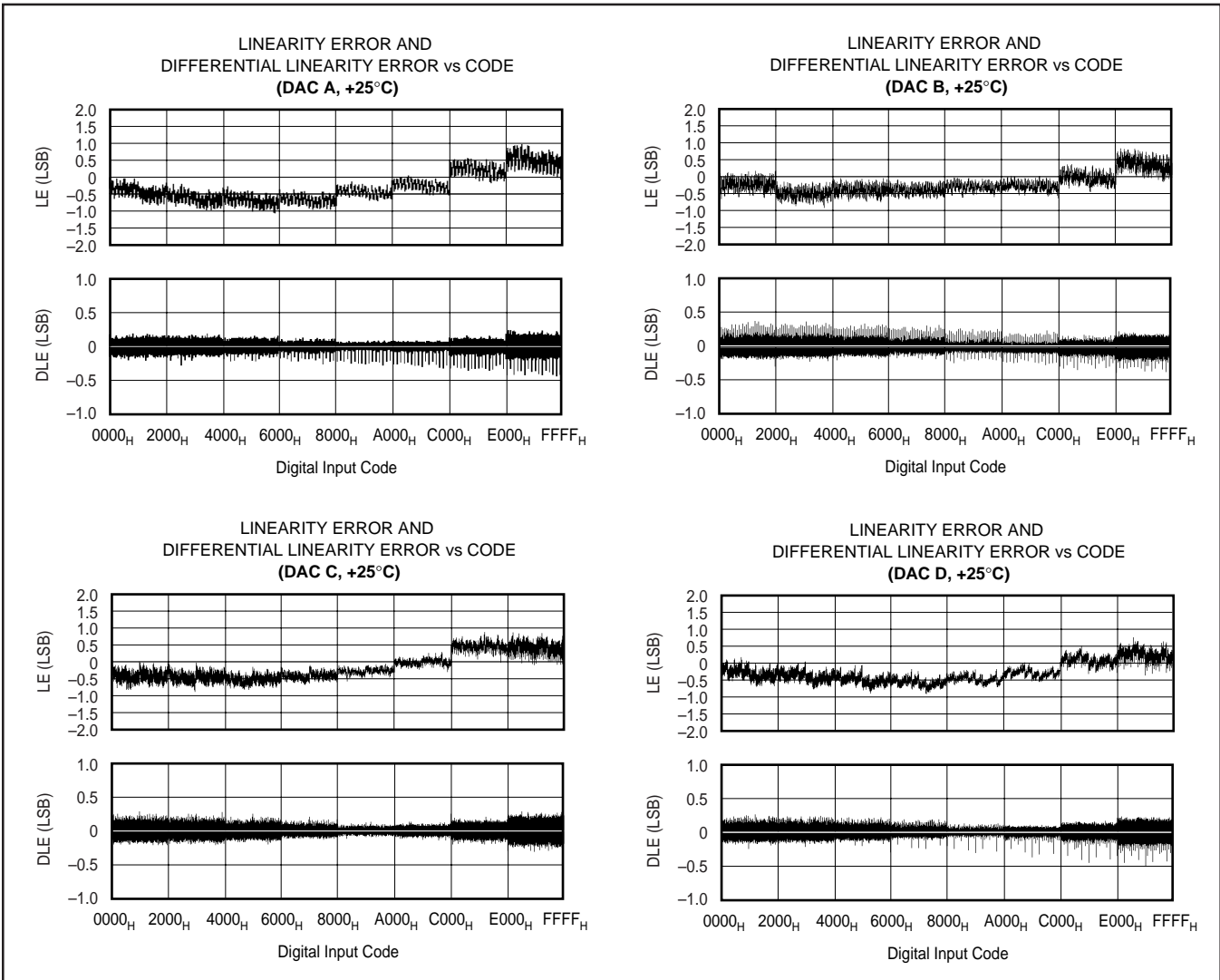

FIGURE 10. Integral Linearity and Differential Linearity Error Curves for Figure 9.

A1	A0	R/W	$\overline{CS}$	RST	RSTSEL	LOADDACS	INPUT REGISTER	DAC REGISTER	MODE	DAC
L	L	L	L	X	X	X	Write	Hold	Write Input	A
L	H	L	L	X	X	X	Write	Hold	Write Input	B
H	L	L	L	X	X	X	Write	Hold	Write Input	C
H	H	L	L	X	X	X	Write	Hold	Write Input	D
L	L	H	L	X	X	X	Read	Hold	Read Input	A
L	H	H	L	X	X	X	Read	Hold	Read Input	B
H	L	H	L	X	X	X	Read	Hold	Read Input	C
H	H	H	L	X	X	X	Read	Hold	Read Input	D
X	X	X	H	X	X	↑	Hold	Write	Update	All
X	X	X	H	X	X	H	Hold	Hold	Hold	All
X	X	X	X	↑	L	X		Reset to Zero	Reset to Zero	All
X	X	X	X	↑	H	X		Reset to Midscale	Reset to Midscale	All

TABLE I. DAC7744 Logic Truth Table.

## DIGITAL INTERFACE

Table I shows the basic control logic for the DAC7744. Note that each DAC register is edge triggered and not level triggered. When the LOADDACS signal is transitioned to HIGH, the digital word currently in the DAC register is latched. The first set of registers (the input registers) are triggered via the A0, A1, R/W, and  $\overline{CS}$  inputs. Only one of these registers is transparent at any given time.

The double-buffered architecture is designed mainly so that each DAC input register can be written to at any time and then all DAC voltages updated simultaneously by the rising edge of LOADDACS. It also allows a DAC input register to be written to at any point then the DAC output voltages can be synchronously changed via a trigger signal connected to LOADDACS.

## DIGITAL TIMING

Figure 11 and Table II provide detailed timing for the digital interface of the DAC7744.

## DIGITAL INPUT CODING

The DAC7744 input data is in Straight Binary format. The output voltage is given by Equation 1.

$$V_{OUT} = V_{REFL} + \frac{(V_{REFH} - V_{REFL}) \cdot N}{65,536} \quad (1)$$

where N is the digital input code. This equation does not include the effects of offset (zero scale) or gain (full scale) errors.

## DIGITALLY-PROGRAMMABLE CURRENT SOURCE

The DAC7744 offers a unique set of features that allows a wide range of flexibility in designing applications circuits such as programmable current sources. The DAC7744 offers both a differential reference input as well as an open-loop configuration around the output amplifier. The open-loop configuration around the output amplifier allows transistor to be placed within the loop to implement a digitally-programmable, uni-directional current source. The availability of a differential reference also allows programmability for both the full-scale and zero-scale currents. The output current is calculated as:

$$I_{OUT} = \left( \left( \frac{V_{REFH} - V_{REFL}}{R_{SENSE}} \right) \cdot \left( \frac{N}{65,536} \right) \right) + (V_{REFL} / R_{SENSE}) \quad (2)$$

Figure 12 shows a DAC7744 in a 4-to-20mA current output configuration. The output current can be determined by Equation 3:

$$I_{OUT} = \left( \left( \frac{5V - 1V}{250\Omega} \right) \cdot \left( \frac{N}{65,536} \right) \right) + \left( \frac{1V}{250\Omega} \right) \quad (3)$$

At full scale, the output current is 16mA plus the 4mA for the zero current. At zero scale, the output current is the offset current of 4mA (1V/250Ω).

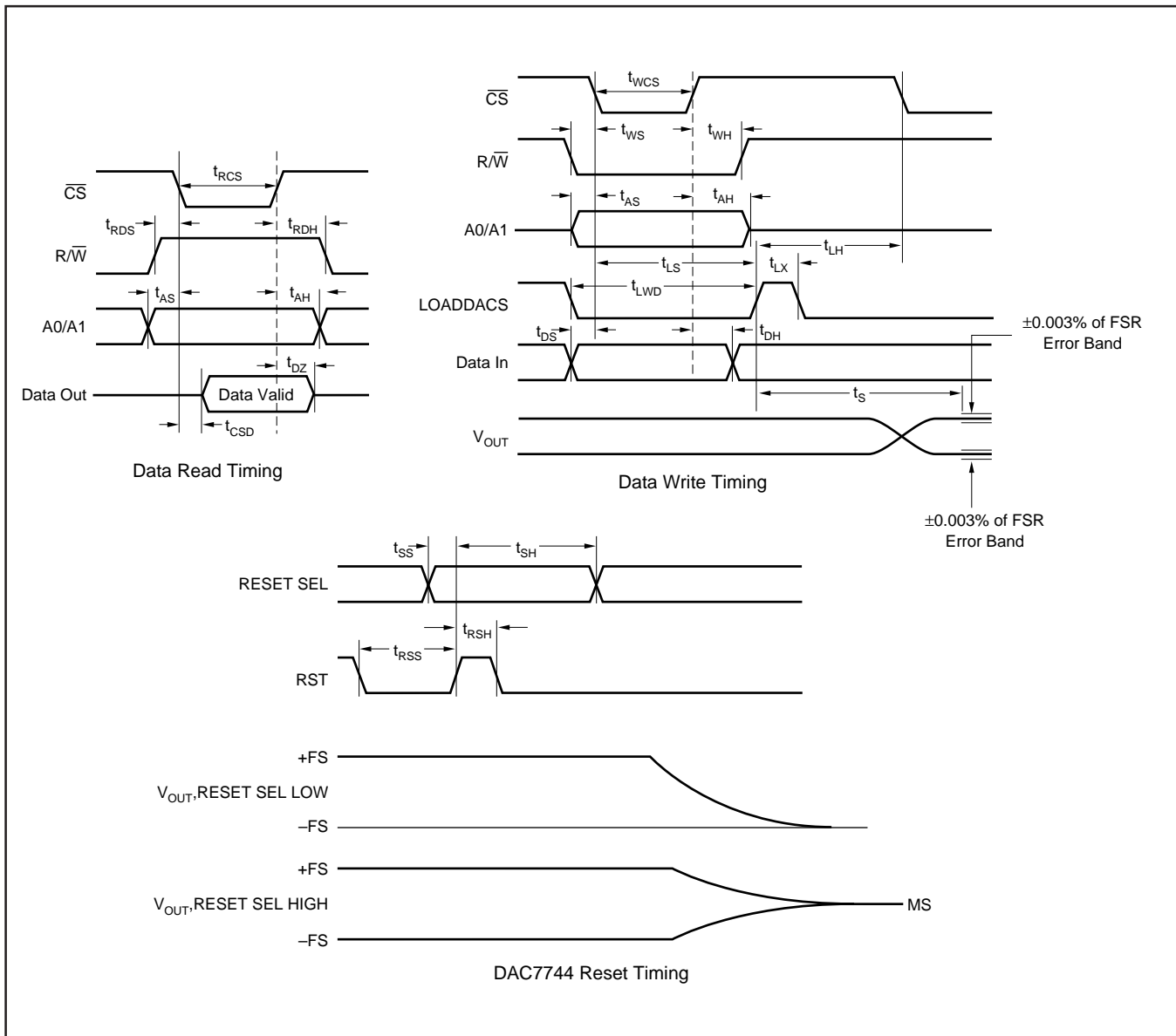

FIGURE 11. Digital Input and Output Timing.

SYMBOL	DESCRIPTION	MIN	TYP	MAX	UNITS
$t_{RCS}$	$\overline{CS}$ LOW for Read	100			ns
$t_{RDS}$	$R/\overline{W}$ HIGH to $\overline{CS}$ LOW	10			ns
$t_{RDH}$	$R/\overline{W}$ HIGH after $\overline{CS}$ HIGH	10			ns
$t_{DZ}$	$\overline{CS}$ HIGH to Data Bus in High Impedance	10		70	ns
$t_{CSD}$	$\overline{CS}$ LOW to Data Bus Valid		85	130	ns
$t_{WCS}$	$\overline{CS}$ LOW for Write	40			ns
$t_{WS}$	$R/\overline{W}$ LOW to $\overline{CS}$ LOW	0			ns
$t_{WH}$	$R/\overline{W}$ LOW after $\overline{CS}$ HIGH	10			ns
$t_{AS}$	Address Valid to $\overline{CS}$ LOW	0			ns
$t_{AH}$	Address Valid after $\overline{CS}$ HIGH	15			ns
$t_{LS}$	$\overline{CS}$ LOW to LOADDACS HIGH	40			ns
$t_{LH}$	$\overline{CS}$ LOW after LOADDACS HIGH	80			ns
$t_{LX}$	LOADDACS HIGH	40			ns
$t_{DS}$	Data Valid to $\overline{CS}$ LOW	0			ns
$t_{DH}$	Data Valid after $\overline{CS}$ HIGH	15			ns
$t_{LWD}$	LOADDACS LOW	40			ns
$t_{SS}$	RSTSEL Valid Before RESET HIGH	0			ns
$t_{SH}$	RSTSEL Valid After RESET HIGH	120			ns
$t_{RSS}$	RESET LOW Before RESET HIGH	10			ns
$t_{RSH}$	RESET LOW After RESET HIGH	10			ns
$t_S$	Settling Time			11	$\mu$ s

TABLE II. Timing Specifications ( $T_A = -40^\circ\text{C}$  to  $+85^\circ\text{C}$ ).

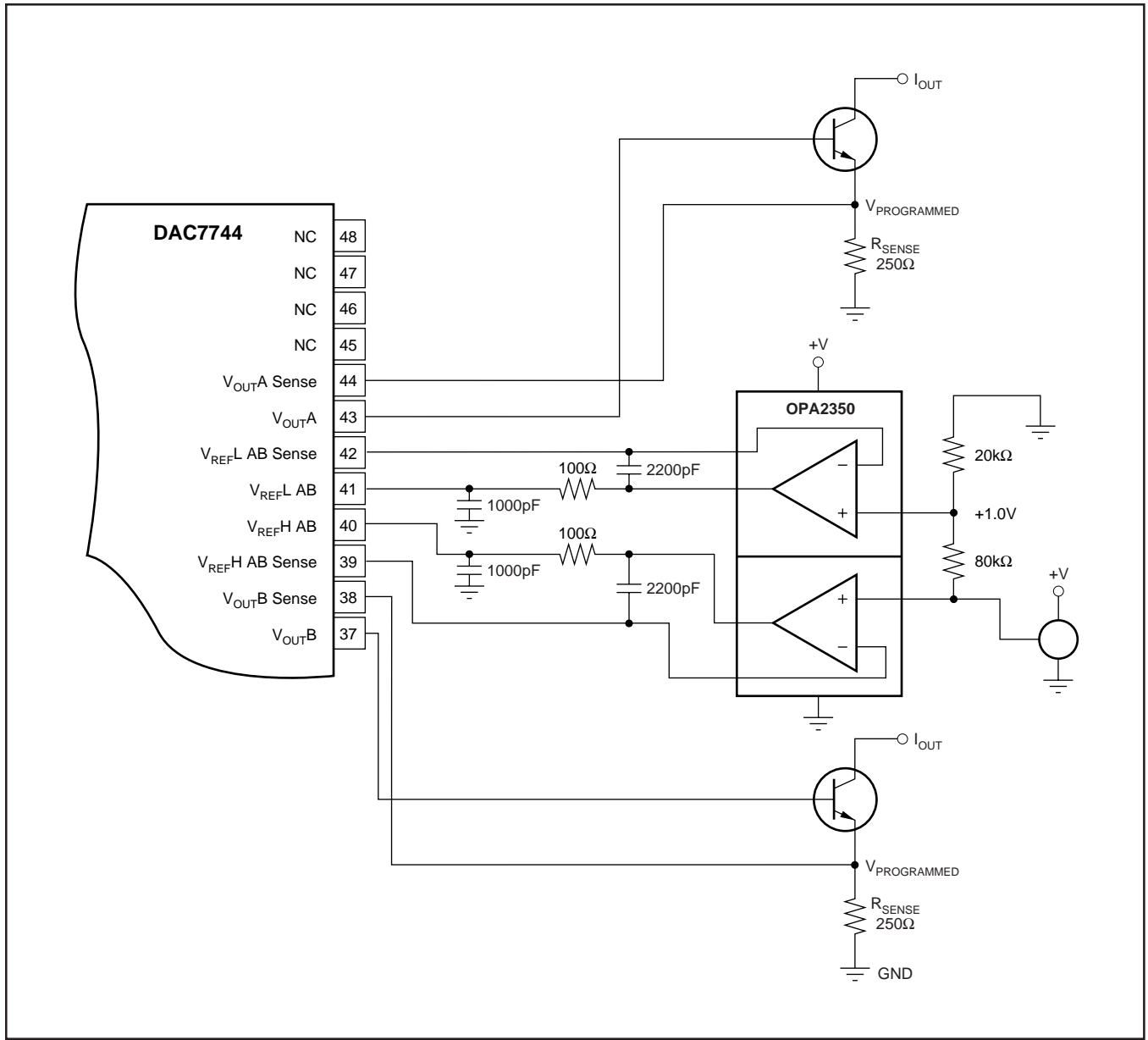

FIGURE 12. 4-to-20mA Digitally-Controlled Current Source (1/2 DAC7744).

## PACKAGING INFORMATION

Orderable Device	Status (1)	Package Type	Package Drawing	Pins	Package Qty	Eco Plan (2)	Lead finish/ Ball material (6)	MSL Peak Temp (3)	Op Temp (°C)	Device Marking (4/5)	Samples
DAC7744E	ACTIVE	SSOP	DL	48	25	RoHS & Green	Call TI	Level-3-260C-168 HR	-40 to 85	DAC7744E	<a href="#">Samples</a>
DAC7744E/1K	ACTIVE	SSOP	DL	48	1000	RoHS & Green	Call TI	Level-3-260C-168 HR	-40 to 85	DAC7744E	<a href="#">Samples</a>
DAC7744E/1KG4	ACTIVE	SSOP	DL	48	1000	RoHS & Green	Call TI	Level-3-260C-168 HR	-40 to 85	DAC7744E	<a href="#">Samples</a>
DAC7744EB	ACTIVE	SSOP	DL	48	25	RoHS & Green	NIPDAU	Level-3-260C-168 HR	-40 to 85	DAC7744E B	<a href="#">Samples</a>
DAC7744EB/1K	ACTIVE	SSOP	DL	48	1000	RoHS & Green	NIPDAU	Level-3-260C-168 HR	-40 to 85	DAC7744E B	<a href="#">Samples</a>
DAC7744EC	ACTIVE	SSOP	DL	48	25	RoHS & Green	Call TI	Level-3-260C-168 HR	-40 to 85	DAC7744E C	<a href="#">Samples</a>
DAC7744EC/1K	ACTIVE	SSOP	DL	48	1000	RoHS & Green	Call TI	Level-3-260C-168 HR	-40 to 85	DAC7744E C	<a href="#">Samples</a>
DAC7744ECG4	ACTIVE	SSOP	DL	48	25	RoHS & Green	Call TI	Level-3-260C-168 HR	-40 to 85	DAC7744E C	<a href="#">Samples</a>

(1) The marketing status values are defined as follows:

**ACTIVE:** Product device recommended for new designs.

**LIFEBUY:** TI has announced that the device will be discontinued, and a lifetime-buy period is in effect.

**NRND:** Not recommended for new designs. Device is in production to support existing customers, but TI does not recommend using this part in a new design.

**PREVIEW:** Device has been announced but is not in production. Samples may or may not be available.

**OBSOLETE:** TI has discontinued the production of the device.

(2) **RoHS:** TI defines "RoHS" to mean semiconductor products that are compliant with the current EU RoHS requirements for all 10 RoHS substances, including the requirement that RoHS substance do not exceed 0.1% by weight in homogeneous materials. Where designed to be soldered at high temperatures, "RoHS" products are suitable for use in specified lead-free processes. TI may reference these types of products as "Pb-Free".

**RoHS Exempt:** TI defines "RoHS Exempt" to mean products that contain lead but are compliant with EU RoHS pursuant to a specific EU RoHS exemption.

**Green:** TI defines "Green" to mean the content of Chlorine (Cl) and Bromine (Br) based flame retardants meet JS709B low halogen requirements of <=1000ppm threshold. Antimony trioxide based flame retardants must also meet the <=1000ppm threshold requirement.

(3) MSL, Peak Temp. - The Moisture Sensitivity Level rating according to the JEDEC industry standard classifications, and peak solder temperature.

(4) There may be additional marking, which relates to the logo, the lot trace code information, or the environmental category on the device.

(5) Multiple Device Markings will be inside parentheses. Only one Device Marking contained in parentheses and separated by a "-" will appear on a device. If a line is indented then it is a continuation of the previous line and the two combined represent the entire Device Marking for that device.

(6) Lead finish/Ball material - Orderable Devices may have multiple material finish options. Finish options are separated by a vertical ruled line. Lead finish/Ball material values may wrap to two lines if the finish value exceeds the maximum column width.

**Important Information and Disclaimer:**The information provided on this page represents TI's knowledge and belief as of the date that it is provided. TI bases its knowledge and belief on information provided by third parties, and makes no representation or warranty as to the accuracy of such information. Efforts are underway to better integrate information from third parties. TI has taken and continues to take reasonable steps to provide representative and accurate information but may not have conducted destructive testing or chemical analysis on incoming materials and chemicals. TI and TI suppliers consider certain information to be proprietary, and thus CAS numbers and other limited information may not be available for release.

In no event shall TI's liability arising out of such information exceed the total purchase price of the TI part(s) at issue in this document sold by TI to Customer on an annual basis.

**TAPE AND REEL INFORMATION**

**QUADRANT ASSIGNMENTS FOR PIN 1 ORIENTATION IN TAPE**

\*All dimensions are nominal

Device	Package Type	Package Drawing	Pins	SPQ	Reel Diameter (mm)	Reel Width W1 (mm)	A0 (mm)	B0 (mm)	K0 (mm)	P1 (mm)	W (mm)	Pin1 Quadrant
DAC7744EB/1K	SSOP	DL	48	1000	330.0	32.4	11.35	16.2	3.1	16.0	32.0	Q1

**TAPE AND REEL BOX DIMENSIONS**

\*All dimensions are nominal

Device	Package Type	Package Drawing	Pins	SPQ	Length (mm)	Width (mm)	Height (mm)
DAC7744EB/1K	SSOP	DL	48	1000	367.0	367.0	55.0

**TUBE**

\*All dimensions are nominal

Device	Package Name	Package Type	Pins	SPQ	L (mm)	W (mm)	T (μm)	B (mm)
DAC7744E	DL	SSOP	48	25	473.7	14.24	5110	7.87
DAC7744EB	DL	SSOP	48	25	473.7	14.24	5110	7.87
DAC7744EC	DL	SSOP	48	25	473.7	14.24	5110	7.87
DAC7744ECG4	DL	SSOP	48	25	473.7	14.24	5110	7.87

## IMPORTANT NOTICE AND DISCLAIMER

TI PROVIDES TECHNICAL AND RELIABILITY DATA (INCLUDING DATA SHEETS), DESIGN RESOURCES (INCLUDING REFERENCE DESIGNS), APPLICATION OR OTHER DESIGN ADVICE, WEB TOOLS, SAFETY INFORMATION, AND OTHER RESOURCES "AS IS" AND WITH ALL FAULTS, AND DISCLAIMS ALL WARRANTIES, EXPRESS AND IMPLIED, INCLUDING WITHOUT LIMITATION ANY IMPLIED WARRANTIES OF MERCHANTABILITY, FITNESS FOR A PARTICULAR PURPOSE OR NON-INFRINGEMENT OF THIRD PARTY INTELLECTUAL PROPERTY RIGHTS.

These resources are intended for skilled developers designing with TI products. You are solely responsible for (1) selecting the appropriate TI products for your application, (2) designing, validating and testing your application, and (3) ensuring your application meets applicable standards, and any other safety, security, regulatory or other requirements.

These resources are subject to change without notice. TI grants you permission to use these resources only for development of an application that uses the TI products described in the resource. Other reproduction and display of these resources is prohibited. No license is granted to any other TI intellectual property right or to any third party intellectual property right. TI disclaims responsibility for, and you will fully indemnify TI and its representatives against, any claims, damages, costs, losses, and liabilities arising out of your use of these resources.

TI's products are provided subject to [TI's Terms of Sale](#) or other applicable terms available either on [ti.com](https://www.ti.com) or provided in conjunction with such TI products. TI's provision of these resources does not expand or otherwise alter TI's applicable warranties or warranty disclaimers for TI products.

TI objects to and rejects any additional or different terms you may have proposed.

Mailing Address: Texas Instruments, Post Office Box 655303, Dallas, Texas 75265  
Copyright © 2024, Texas Instruments Incorporated

## Looking for pricing, stock, or lifecycle information?

Click below to explore more details on WIN SOURCE:

 [View DAC7744EC](#) on WIN SOURCE

 [Texas Instruments](#) Information

## Optimize Your Supply Chain with WIN SOURCE Solutions

-  Global Sourcing Solution
-  Obsolete Management
-  Cost Control Management
-  Shortage Management
-  Alternative Solution
-  Excess Inventory Management