



**THE DATASHEET OF
LT8640HUDCF#PBF**



42V, 5A Synchronous Step-Down Silent Switcher with 2.5µA Quiescent Current

FEATURES

- **Silent Switcher® Architecture**
 - **Ultralow EMI Emissions**
 - **Spread Spectrum Frequency Modulation**
- **High Efficiency at High Frequency**
 - **Up to 96% Efficiency at 1MHz, 12VIN to 5VOUT**
 - **Up to 95% Efficiency at 2MHz, 12VIN to 5VOUT**
- **Wide Input Voltage Range: 3.4V to 42V**
- **5A Maximum Continuous Output, 7A Peak Transient Output**
- **Ultralow Quiescent Current Burst Mode® Operation**
 - **2.5µA IQ Regulating 12VIN to 3.3VOUT**
 - **Output Ripple < 10mVp-p**
- **Fast Minimum Switch On-Time: 30ns**
- **Low Dropout Under All Conditions: 100mV at 1A**
- **Forced Continuous Mode (LT8640-1 Only)**
- **Safely Tolerates Inductor Saturation in Overload**
- **Adjustable and Synchronizable: 200kHz to 3MHz**
- **Peak Current Mode Operation**
- **Output Soft-Start and Tracking**
- **Small 18-Lead 3mm × 4mm QFN and Side Wettable QFN**
- **AEC-Q100 Qualified for Automotive Applications**

APPLICATIONS

- Automotive and Industrial Supplies
- General Purpose Step-Down
- GSM Power Supplies

DESCRIPTION

The **LT®8640/LT8640-1** step-down regulator features Silent Switcher architecture designed to minimize EMI emissions while delivering high efficiency at frequencies up to 3MHz. An ultralow 2.5µA quiescent current—with the output in full regulation—enables applications requiring highest efficiency at very small load currents.

The LT8640/LT8640-1 allows high VIN to low VOUT conversion at high frequency with a fast minimum top switch on-time of 30ns. The SYNC/MODE pin selects between Burst Mode operation, spread spectrum mode, synchronization to an external clock, and either pulse-skipping (LT8640) or forced continuous mode (LT8640-1).

	PACKAGE	SYNC/MODE ≠ 0	V _C COMP	150°C GRADE	CLKOUT	INTERNAL CAPS
LT8640	QFN	Pulse-Skipping	Internal	Yes	No	No
LT8640-1	QFN	FCM	Internal	Yes	No	No
LT8640S	LQFN	FCM	Internal	No	Yes	Yes
LT8643S	LQFN	FCM	External	No	Yes	Yes
LT8640S-2	LQFN	FCM	Internal	Yes	Yes	No
LT8643S-2	LQFN	FCM	External	Yes	Yes	No

All registered trademarks and trademarks are the property of their respective owners. Protected by U.S. patents, including 8823345.

TYPICAL APPLICATION

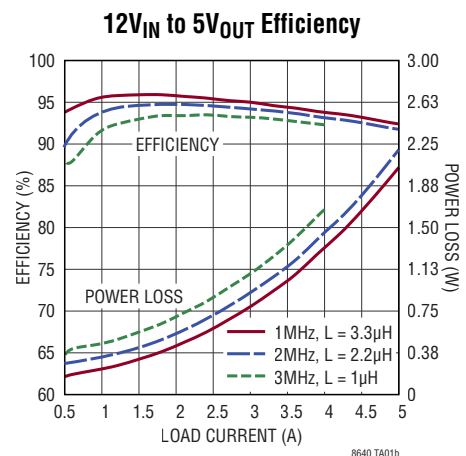
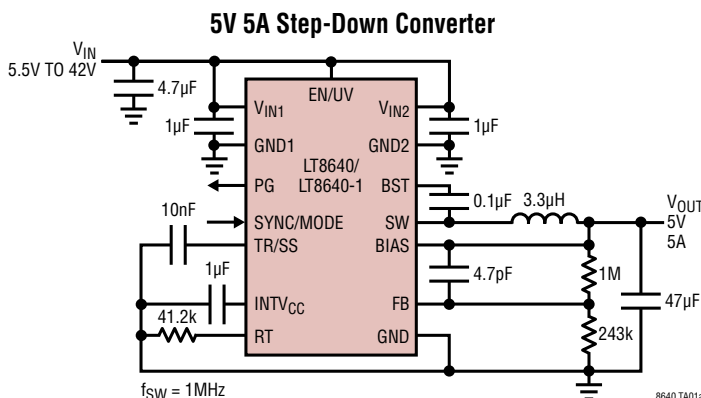

LT8640/LT8640-1

ABSOLUTE MAXIMUM RATINGS

(Note 1)

V_{IN} , EN/UV, PG	42V
BIAS	25V
FB, TR/SS	4V
SYNC/MODE Voltage	6V
Operating Junction Temperature Range (Note 2)	
LT8640E/LT8640-1E	-40°C to 125°C
LT8640I/LT8640-1I	-40°C to 125°C
LT8640J/LT8640-1J	-40°C to 150°C
LT8640H/LT8640-1H	-40°C to 150°C
Storage Temperature Range	-65 to 150°C

PIN CONFIGURATION

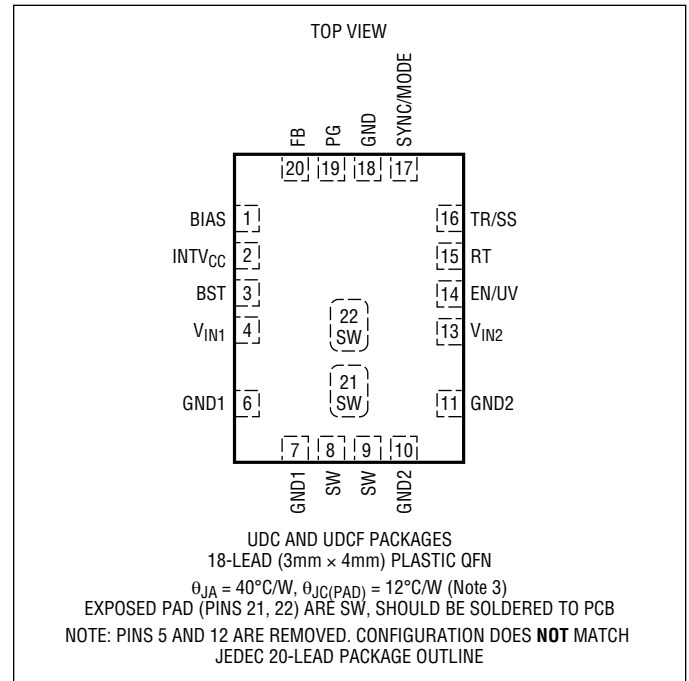

ORDER INFORMATION

LEAD FREE FINISH	TAPE AND REEL	PART MARKING*	PACKAGE DESCRIPTION	TEMPERATURE RANGE
LT8640EUDC#PBF	LT8640EUDC#TRPBF	LGNJ	18-Lead (3mm × 4mm) Plastic QFN	-40°C to 125°C
LT8640IUDC#PBF	LT8640IUDC#TRPBF	LGNJ	18-Lead (3mm × 4mm) Plastic QFN	-40°C to 125°C
LT8640HUDC#PBF	LT8640HUDC#TRPBF	LGNJ	18-Lead (3mm × 4mm) Plastic QFN	-40°C to 150°C
LT8640EUDC-1#PBF	LT8640EUDC-1#TRPBF	LGVT	18-Lead (3mm × 4mm) Plastic QFN	-40°C to 125°C
LT8640IUDC-1#PBF	LT8640IUDC-1#TRPBF	LGVT	18-Lead (3mm × 4mm) Plastic QFN	-40°C to 125°C
LT8640HUDC-1#PBF	LT8640HUDC-1#TRPBF	LGVT	18-Lead (3mm × 4mm) Plastic QFN	-40°C to 150°C
LT8640EUDCF#PBF	LT8640EUDCF#TRPBF	LHJK	18-Lead (3mm × 4mm) Plastic Side Wettable QFN	-40°C to 125°C
LT8640IUDCF#PBF	LT8640IUDCF#TRPBF	LHJK	18-Lead (3mm × 4mm) Plastic Side Wettable QFN	-40°C to 125°C
LT8640JUDCF#PBF	LT8640JUDCF#TRPBF	LHJK	18-Lead (3mm × 4mm) Plastic Side Wettable QFN	-40°C to 150°C
LT8640HUDCF#PBF	LT8640HUDCF#TRPBF	LHJK	18-Lead (3mm × 4mm) Plastic Side Wettable QFN	-40°C to 150°C
LT8640EUDCF-1#PBF	LT8640EUDCF-1#TRPBF	LHGX	18-Lead (3mm × 4mm) Plastic Side Wettable QFN	-40°C to 125°C
LT8640IUDCF-1#PBF	LT8640IUDCF-1#TRPBF	LHGX	18-Lead (3mm × 4mm) Plastic Side Wettable QFN	-40°C to 125°C
LT8640JUDCF-1#PBF	LT8640JUDCF-1#TRPBF	LHGX	18-Lead (3mm × 4mm) Plastic Side Wettable QFN	-40°C to 150°C
AUTOMOTIVE PRODUCTS**				
LT8640JUDCF#WPBF	LT8640JUDCF#WTRPBF	LHJK	18-Lead (3mm × 4mm) Plastic Side Wettable QFN	-40°C to 150°C
LT8640JUDCF-1#WPBF	LT8640JUDCF-1#WTRPBF	LHGX	18-Lead (3mm × 4mm) Plastic Side Wettable QFN	-40°C to 150°C

Contact the factory for parts specified with wider operating temperature ranges. *The temperature grade is identified by a label on the shipping container.

Tape and reel specifications. Some packages are available in 500 unit reels through designated sales channels with #TRMPBF suffix.

**Versions of this part are available with controlled manufacturing to support the quality and reliability requirements of automotive applications. These models are designated with a #W suffix. Only the automotive grade products shown are available for use in automotive applications. Contact your local Analog Devices account representative for specific product ordering information and to obtain the specific Automotive Reliability reports for these models.

Rev. E

ELECTRICAL CHARACTERISTICS The ● denotes the specifications which apply over the full operating temperature range, otherwise specifications are at $T_A = 25^\circ\text{C}$.

PARAMETER	CONDITIONS		MIN	TYP	MAX	UNITS
Minimum Input Voltage		●		2.9	3.4	V
V_{IN} Quiescent Current	$V_{EN/UV} = 0V$	●		0.75	3	μA
		●		0.75	10	μA
	$V_{EN/UV} = 2V$, Not Switching, $V_{SYNC} = 0V$	●		1.7	4	μA
		●		1.7	10	μA
	$V_{EN/UV} = 2V$, Not Switching, $V_{SYNC} = 2V$ (LT8640 Only)			0.3	0.5	mA
V_{IN} Current in Regulation	$V_{OUT} = 0.97V$, $V_{IN} = 6V$, Output Load = $100\mu\text{A}$ $V_{OUT} = 0.97V$, $V_{IN} = 6V$, Output Load = 1mA	●		21	50	μA
		●		220	350	μA
Feedback Reference Voltage	$V_{IN} = 6V$, $I_{LOAD} = 0.5A$ $V_{IN} = 6V$, $I_{LOAD} = 0.5A$		0.964	0.970	0.976	V
		●	0.958	0.970	0.982	V
Feedback Voltage Line Regulation	$V_{IN} = 4.0V$ to $42V$	●		0.004	0.02	%/V
Feedback Pin Input Current	$V_{FB} = 1V$		-20		20	nA
BIAS Pin Current Consumption	$V_{BIAS} = 3.3V$, $f_{SW} = 2\text{MHz}$			11		mA
Minimum On-Time	$I_{LOAD} = 1.5A$, $SYNC = 0V$ $I_{LOAD} = 1.5A$, $SYNC = 3.3V$	●		35	50	ns
		●		30	50	ns
Minimum Off-Time				80	110	ns
Oscillator Frequency	$R_T = 221k$ $R_T = 60.4k$ $R_T = 18.2k$	●	180	210	240	kHz
		●	665	700	735	kHz
		●	1.85	2.00	2.15	MHz
Top Power NMOS On-Resistance	$I_{SW} = 1A$			67		m Ω
Top Power NMOS Current Limit		●	7.5	10	12.5	A
Bottom Power NMOS On-Resistance	$V_{INTVCC} = 3.4V$, $I_{SW} = 1A$			28		m Ω
SW Leakage Current	$V_{IN} = 42V$, $V_{SW} = 0V$, $42V$		-15		15	μA
EN/UV Pin Threshold	EN/UV Rising	●	0.94	1.0	1.06	V
EN/UV Pin Hysteresis				40		mV
EN/UV Pin Current	$V_{EN/UV} = 2V$		-20		20	nA
PG Upper Threshold Offset from V_{FB}	V_{FB} Falling	●	5	7.5	10.25	%
PG Lower Threshold Offset from V_{FB}	V_{FB} Rising	●	-5.25	-8	-10.75	%
PG Hysteresis				0.2		%
PG Leakage	$V_{PG} = 3.3V$		-40		40	nA
PG Pull-Down Resistance	$V_{PG} = 0.1V$	●		700	2000	Ω
SYNC/MODE Threshold	SYNC/MODE DC and Clock Low Level Voltage SYNC/MODE Clock High Level Voltage SYNC/MODE DC High Level Voltage		0.7	0.9	1.1	V
			1.0	1.2	1.4	V
			2.3	2.6	2.9	V
Spread Spectrum Modulation Frequency Range	$R_T = 60.4k$, $V_{SYNC} = 3.3V$			22		%
Spread Spectrum Modulation Frequency	$V_{SYNC} = 3.3V$			3		kHz
TR/SS Source Current		●	1.2	1.9	2.6	μA
TR/SS Pull-Down Resistance	Fault Condition, TR/SS = $0.1V$			200		Ω

LT8640/LT8640-1

ELECTRICAL CHARACTERISTICS

The ● denotes the specifications which apply over the full operating temperature range, otherwise specifications are at $T_A = 25^\circ\text{C}$.

PARAMETER	CONDITIONS	MIN	TYP	MAX	UNITS
LT8640-1 Output Sink Current in Forced Continuous Mode	$V_{FB} = 1.01\text{V}$, $L = 6.8\mu\text{H}$, $R_T = 60.4\text{k}$	0.25	0.6	1	A
LT8640-1 V_{IN} to Disable Forced Continuous Mode	V_{IN} Rising	35	37	39	V
LT8640-1 V_{FB} Offset from Feedback Reference Voltage to Disable Forced Continuous Mode	V_{FB} Rising	7	9.5	12	%

Note 1: Stresses beyond those listed under Absolute Maximum Ratings may cause permanent damage to the device. Exposure to any Absolute Maximum Rating condition for extended periods may affect device reliability and lifetime.

Note 2: The LT8640E/LT8640-1E is guaranteed to meet performance specifications from 0°C to 125°C junction temperature. Specifications over the -40°C to 125°C operating junction temperature range are assured by design, characterization, and correlation with statistical process controls. The LT8640I/LT8640-1I is guaranteed over the full -40°C to 125°C operating junction temperature range. The LT8640J/LT8640-1J and the LT8640H/LT8640-1H is guaranteed over the full -40°C to 150°C operating junction temperature range. High junction temperatures degrade operating lifetimes. Operating lifetime is derated at junction temperatures greater than 125°C . The junction temperature (T_J , in $^\circ\text{C}$) is calculated from the

ambient temperature (T_A in $^\circ\text{C}$) and power dissipation (PD, in Watts) according to the formula:

$$T_J = T_A + (PD \cdot \theta_{JA})$$

where θ_{JA} (in $^\circ\text{C}/\text{W}$) is the package thermal impedance.

Note 3: θ values determined per JEDEC 51-7, 51-12. See Applications Information section for information on improving the thermal resistance and for actual temperature measurements of a demo board in typical operating conditions.

Note 4: This IC includes overtemperature protection that is intended to protect the device during overload conditions. Junction temperature will exceed 150°C when overtemperature protection is active. Continuous operation above the specified maximum operating junction temperature will reduce lifetime.

TYPICAL PERFORMANCE CHARACTERISTICS

12V_{IN} to 5V_{OUT} Efficiency vs Frequency

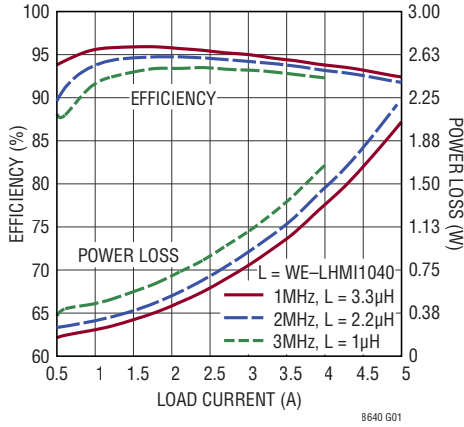

8640 G01

12V_{IN} to 3.3V_{OUT} Efficiency vs Frequency

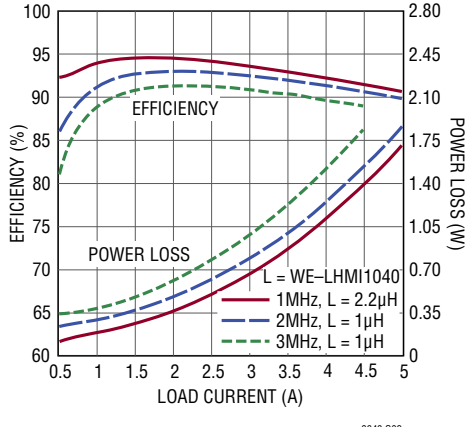

8640 G02

Efficiency at 5V_{OUT}

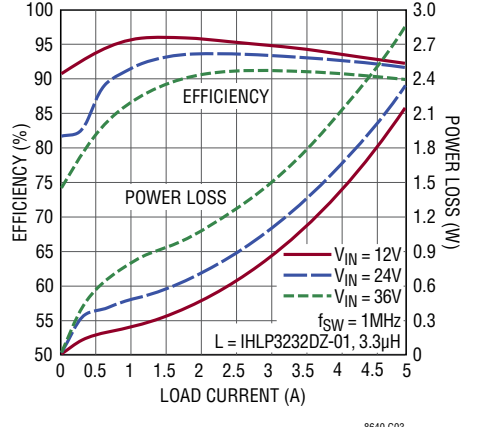

8640 G03

Efficiency at 3.3V_{OUT}

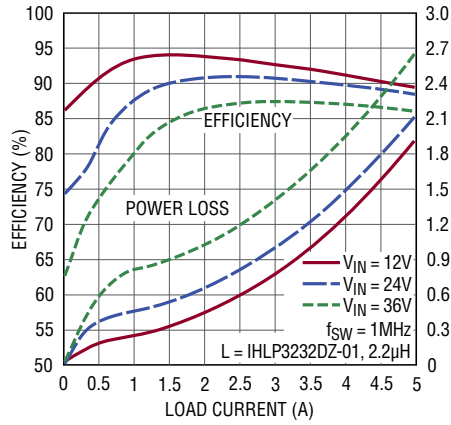

8640 G04

Efficiency at 5V_{OUT}

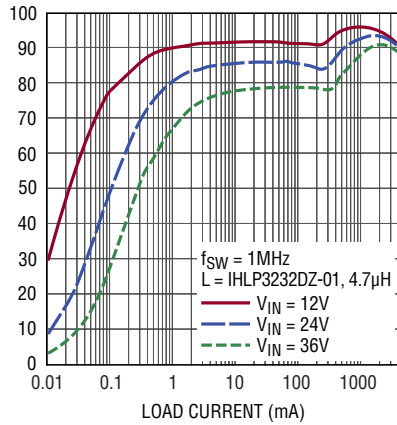

8640 G05

Efficiency at 3.3V_{OUT}

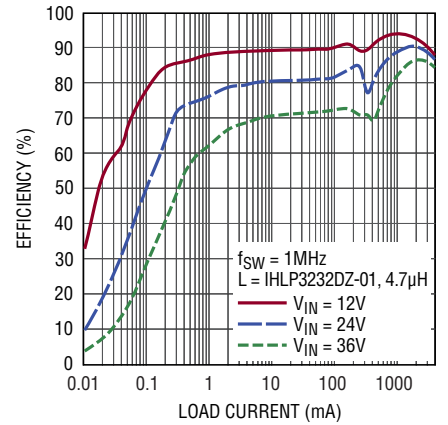

8640 G06

Efficiency vs Frequency

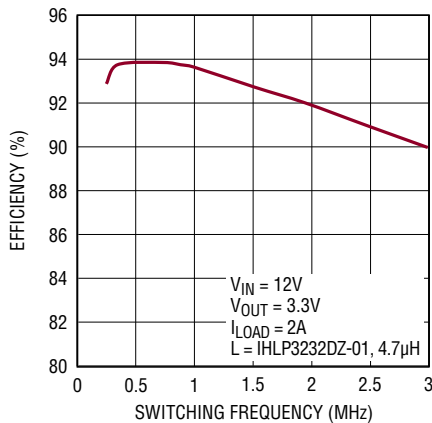

8640 G07

Burst Mode Operation Efficiency vs Inductor Value

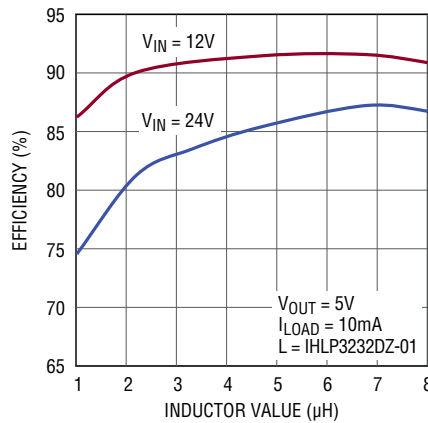

8640 G08

Reference Voltage

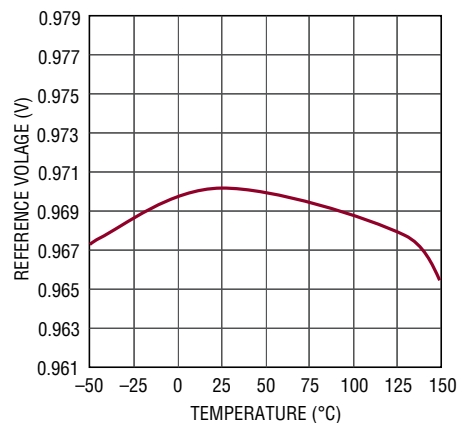

8640 G09

TYPICAL PERFORMANCE CHARACTERISTICS

EN Pin Thresholds

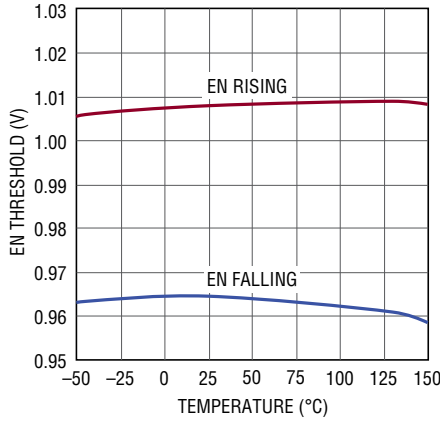

8640 G10

Load Regulation

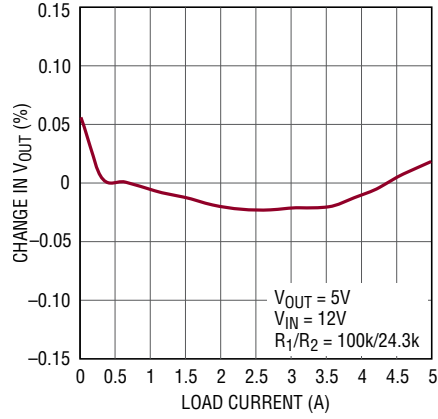

8640 G11

Line Regulation

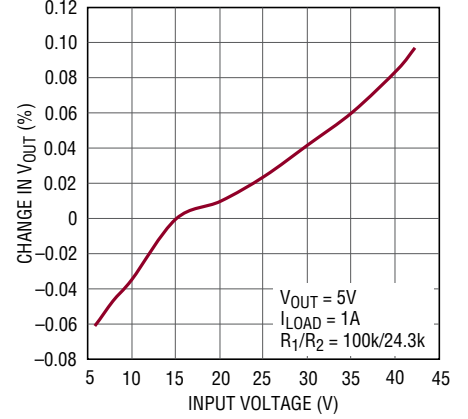

8640 G12

No-Load Supply Current

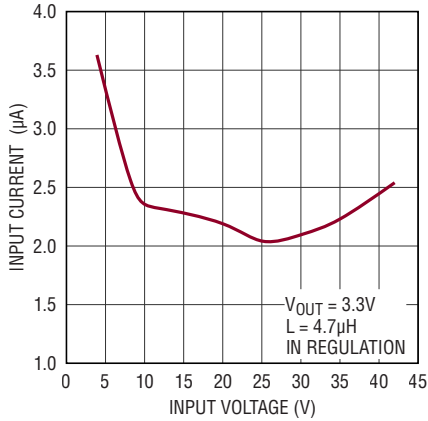

8640 G13

Top FET Current Limit vs Duty Cycle

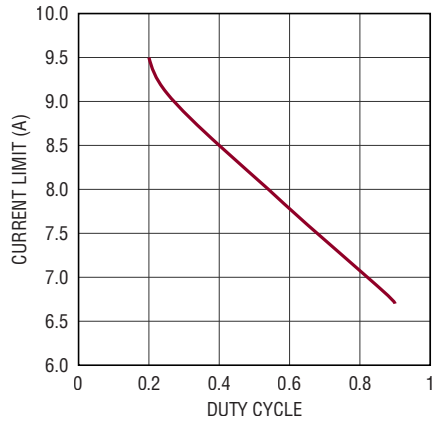

8640 G14

Top FET Current Limit

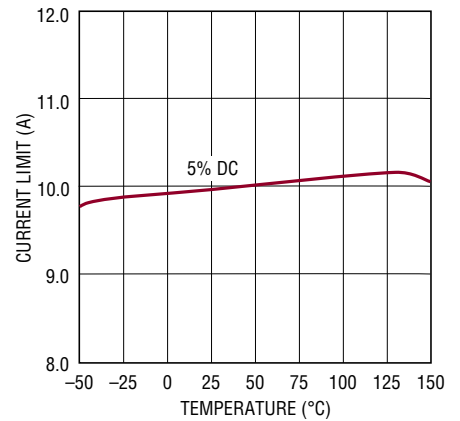

8640 G15

Switch Drop

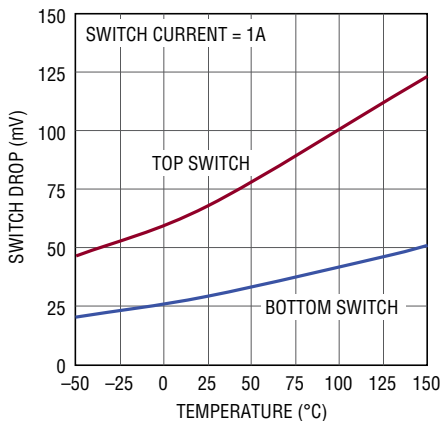

8640 G16

Switch Drop

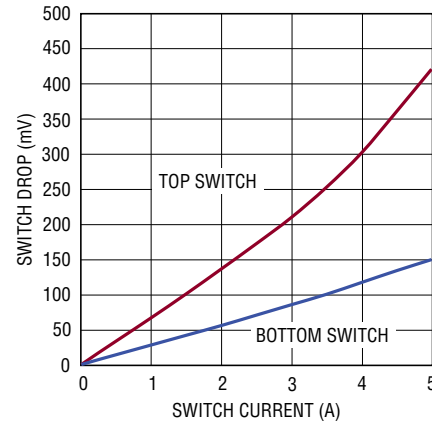

8640 G17

Minimum On-Time

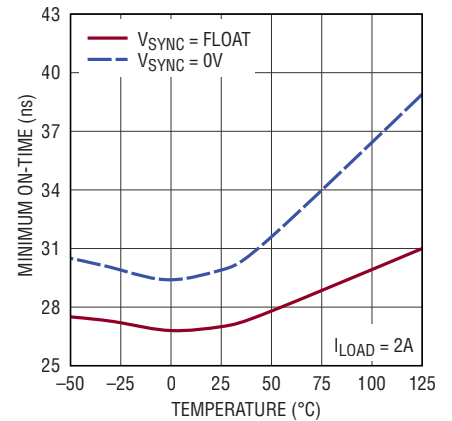

8640 G18

TYPICAL PERFORMANCE CHARACTERISTICS

Dropout Voltage

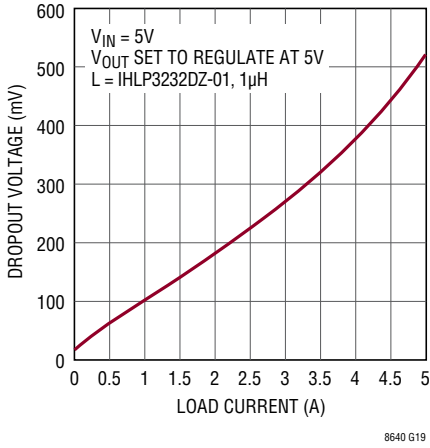

8640 G19

Switching Frequency

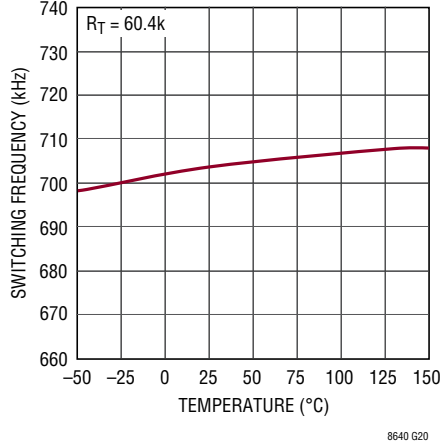

8640 G20

Burst Frequency

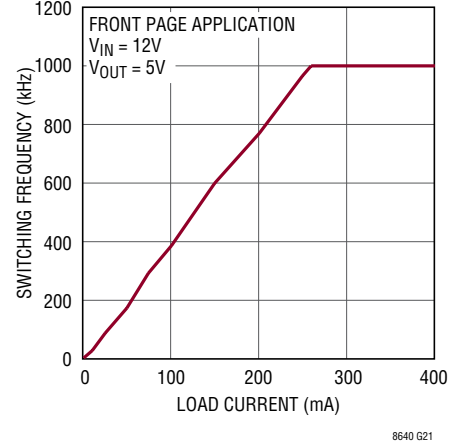

8640 G21

Minimum Load to Full Frequency (Pulse-Skipping Mode)

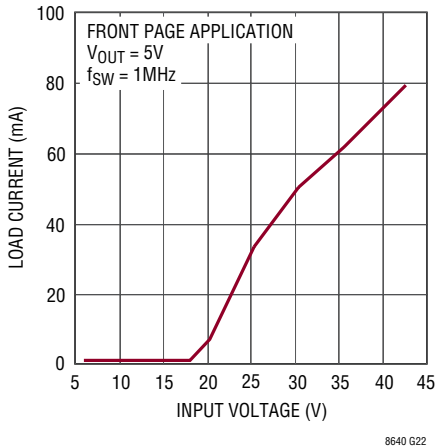

8640 G22

Frequency Foldback

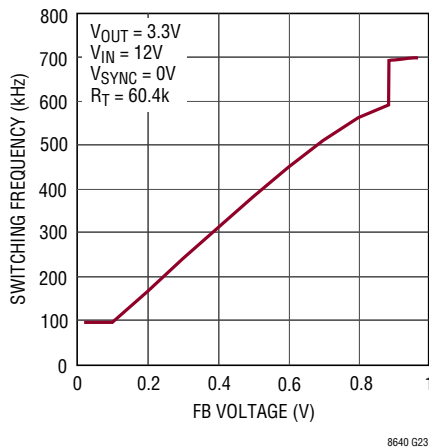

8640 G23

Soft-Start Tracking

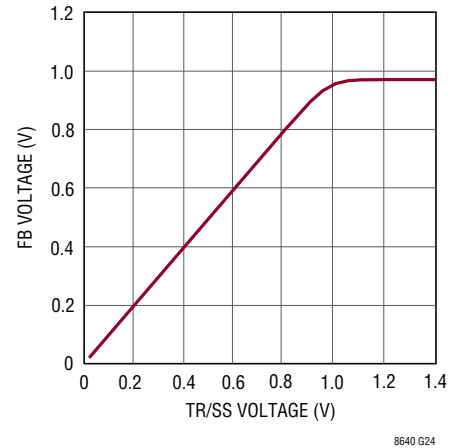

8640 G24

Soft-Start Current

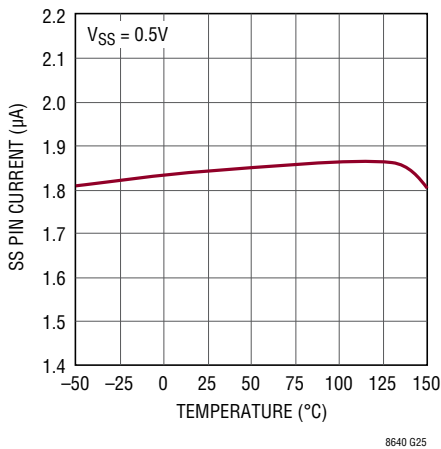

8640 G25

PG High Thresholds

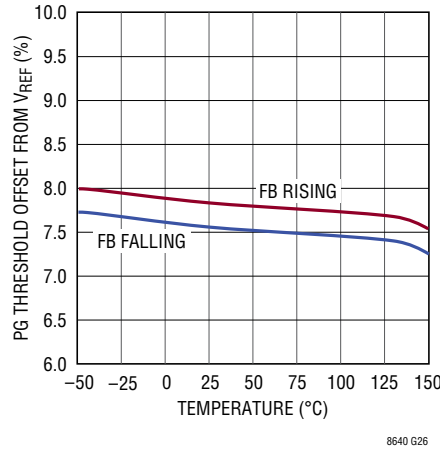

8640 G26

PG Low Thresholds

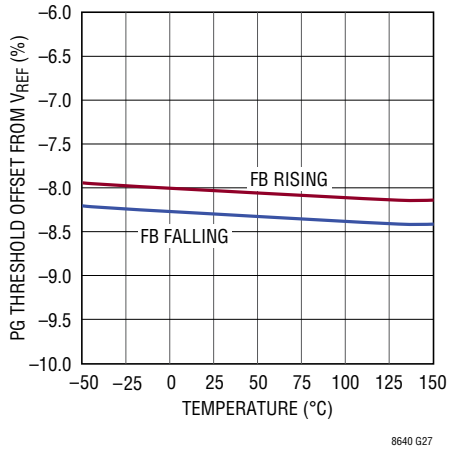

8640 G27

TYPICAL PERFORMANCE CHARACTERISTICS

RT Programmed Switching Frequency

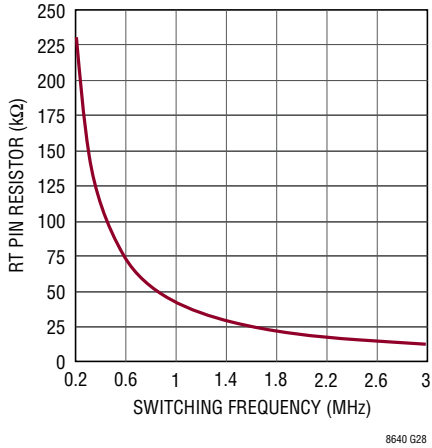

V_{IN} UVLO

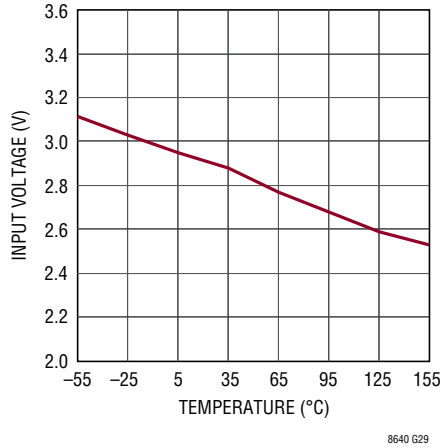

Bias Pin Current

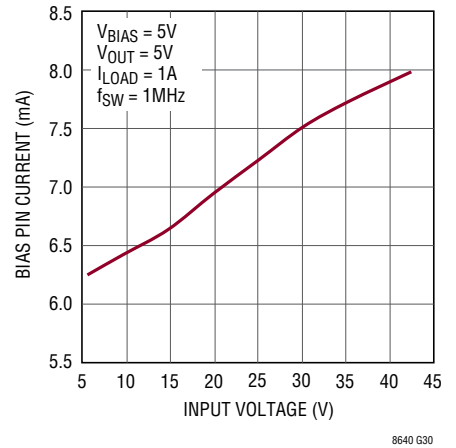

Bias Pin Current

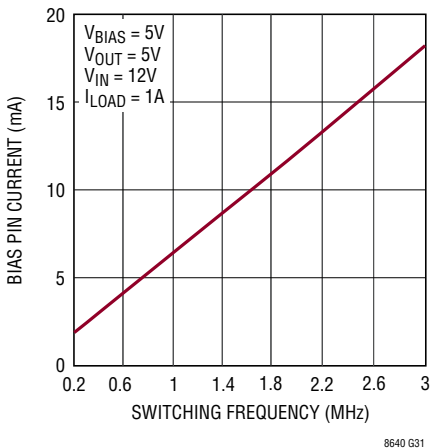

Case Temperature Rise

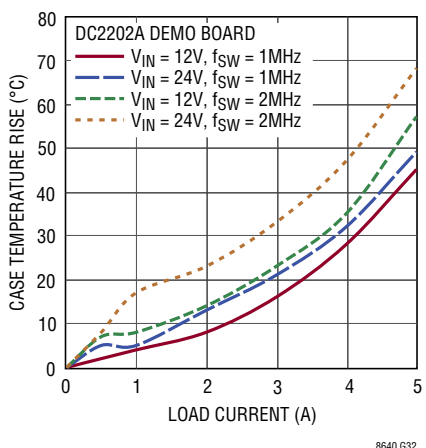

Case Temperature Rise vs 7A Pulsed Load

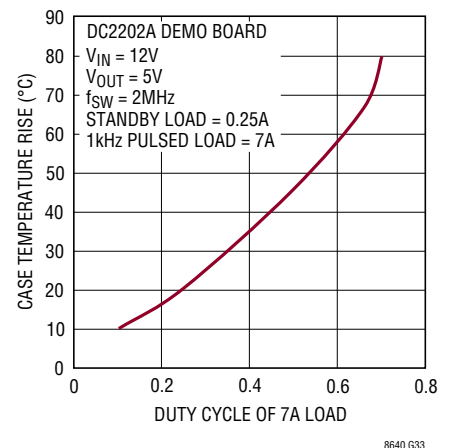

Switching Waveforms, Full Frequency Continuous Operation

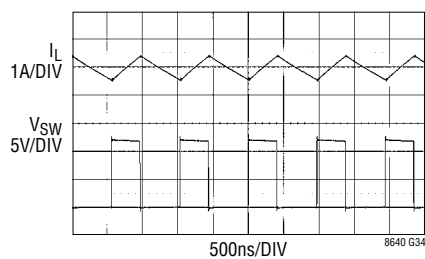

FRONT PAGE APPLICATION
12V_{IN} TO 5V_{OUT} AT 1A

Switching Waveforms, Burst Mode Operation

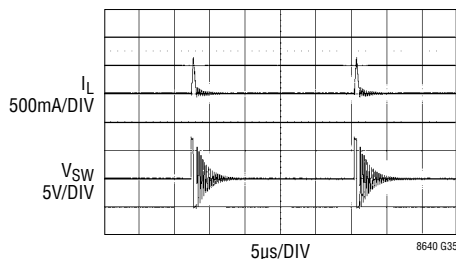

FRONT PAGE APPLICATION
12V_{IN} TO 5V_{OUT} AT 10mA
V_{SYNC} = 0V

Switching Waveforms

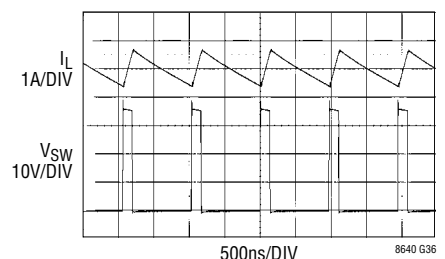

FRONT PAGE APPLICATION
36V_{IN} TO 5V_{OUT} AT 1A

TYPICAL PERFORMANCE CHARACTERISTICS

Transient Response; Load Current Stepped from 1A to 2A

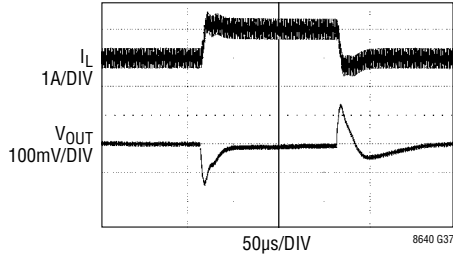

FRONT PAGE APPLICATION
1A TO 2A TRANSIENT
12VIN, 5VOUT
COUT = 47µF

Transient Response; Load Current Stepped from 100mA (Burst Mode Operation) to 1.1A

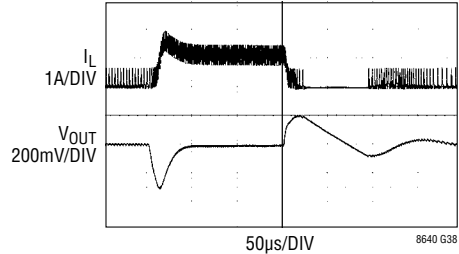

FRONT PAGE APPLICATION
100mA (Burst Mode OPERATION) TO
1.1A TRANSIENT
12VIN, 5VOUT
COUT = 47µF

Start-Up Dropout Performance

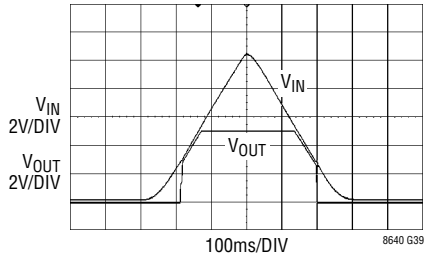

2.5Ω LOAD
(2A IN REGULATION)

Start-Up Dropout Performance

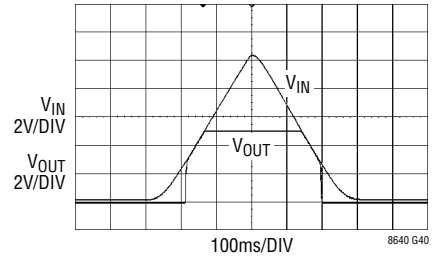

20Ω LOAD
(250mA IN REGULATION)

Conducted EMI Performance

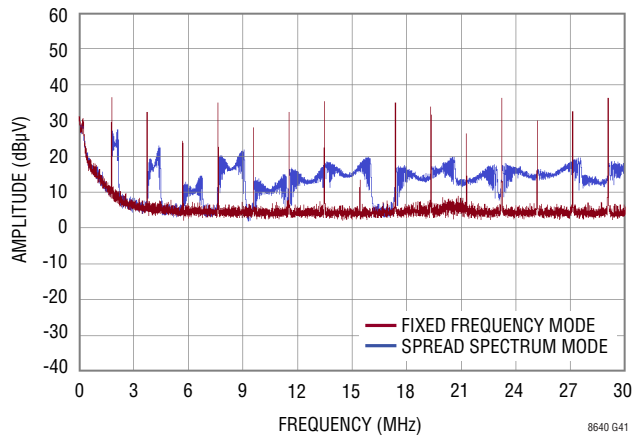

DC2202A DEMO BOARD
(WITH EMI FILTER INSTALLED)
14V INPUT TO 5V OUTPUT AT 4A, f_{SW} = 2MHz

TYPICAL PERFORMANCE CHARACTERISTICS

**Radiated EMI Performance
(CISPR25 Radiated Emission Test with Class 5 Peak Limits)**

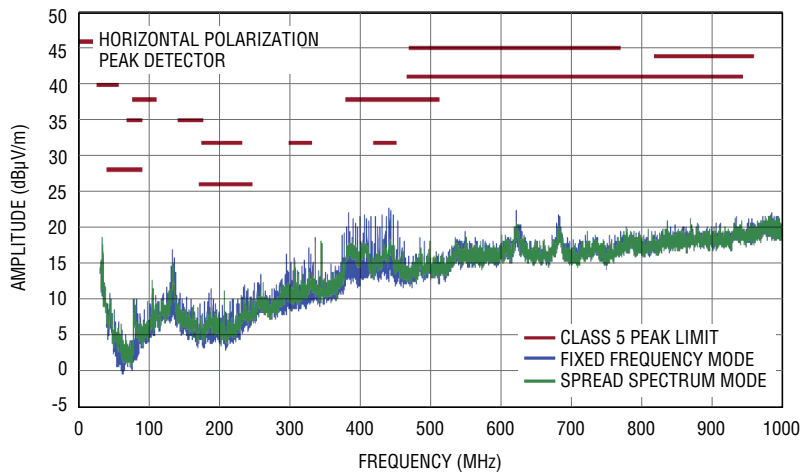
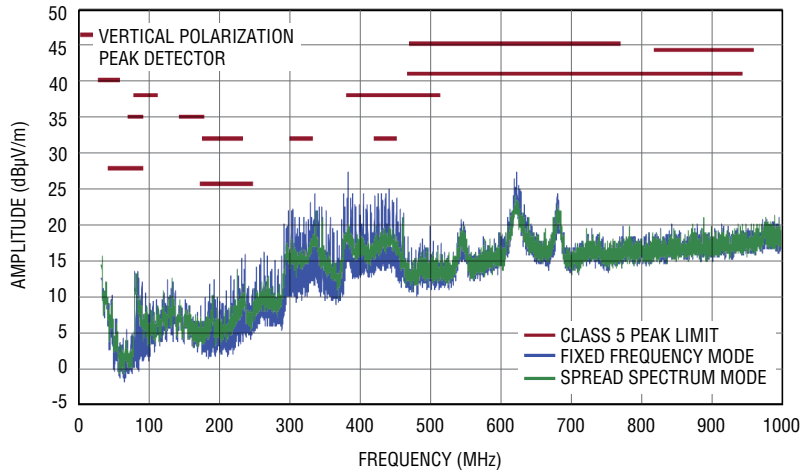

DC2202A DEMO BOARD
(WITH EMI FILTER INSTALLED)
14V INPUT TO 5V OUTPUT AT 4A, $f_{SW} = 2\text{MHz}$

8640 G42

PIN FUNCTIONS

BIAS (Pin 1): The internal regulator will draw current from BIAS instead of V_{IN} when BIAS is tied to a voltage higher than 3.1V. For output voltages of 3.3V to 25V this pin should be tied to V_{OUT} . If this pin is tied to a supply other than V_{OUT} use a 1 μ F local bypass capacitor on this pin. If no supply is available, tie to GND.

INTV_{CC} (Pin 2): Internal 3.4V Regulator Bypass Pin. The internal power drivers and control circuits are powered from this voltage. INTV_{CC} maximum output current is 20mA. Do not load the INTV_{CC} pin with external circuitry. INTV_{CC} current will be supplied from BIAS if BIAS > 3.1V, otherwise current will be drawn from V_{IN} . Voltage on INTV_{CC} will vary between 2.8V and 3.4V when BIAS is between 3.0V and 3.6V. Decouple this pin to power ground with at least a 1 μ F low ESR ceramic capacitor placed close to the IC.

BST (Pin 3): This pin is used to provide a drive voltage, higher than the input voltage, to the topside power switch. Place a 0.1 μ F boost capacitor as close as possible to the IC.

V_{IN1} (Pin 4): The LT8640/LT8640-1 requires two 1 μ F small input bypass capacitors. One 1 μ F capacitor should be placed between V_{IN1} and GND1. A second 1 μ F capacitor should be placed between V_{IN2} and GND2. These capacitors must be placed as close as possible to the LT8640/LT8640-1. A third larger capacitor of 2.2 μ F or more should be placed close to the LT8640/LT8640-1 with the positive terminal connected to V_{IN1} and V_{IN2} , and the negative terminal connected to ground. See applications section for sample layout.

GND1 (6, 7): Power Switch Ground. These pins are the return path of the internal bottom side power switch and must be tied together. Place the negative terminal of the input capacitor as close to the GND1 pins as possible. Also be sure to tie GND1 to the ground plane. See the Applications Information section for sample layout.

SW (Pins 8, 9): The SW pins are the outputs of the internal power switches. Tie these pins together and connect them to the inductor and boost capacitor. This node should be kept small on the PCB for good performance and low EMI.

GND2 (10, 11): Power Switch Ground. These pins are the return path of the internal bottom side power switch and must be tied together. Place the negative terminal of the input capacitor as close to the GND2 pins as possible. Also

be sure to tie GND2 to the ground plane. See the Applications Information section for sample layout.

V_{IN2} (Pin 13): The LT8640/LT8640-1 requires two 1 μ F small input bypass capacitors. One 1 μ F capacitor should be placed between V_{IN1} and GND1. A second 1 μ F capacitor should be placed between V_{IN2} and GND2. These capacitors must be placed as close as possible to the LT8640/LT8640-1. A third larger capacitor of 2.2 μ F or more should be placed close to the LT8640/LT8640-1 with the positive terminal connected to V_{IN1} and V_{IN2} , and the negative terminal connected to ground. See the Applications Information section for sample layout.

EN/UV (Pin 14): The LT8640/LT8640-1 is shut down when this pin is low and active when this pin is high. The hysteretic threshold voltage is 1.00V going up and 0.96V going down. Tie to V_{IN} if the shutdown feature is not used. An external resistor divider from V_{IN} can be used to program a V_{IN} threshold below which the LT8640/LT8640-1 will shut down.

RT (Pin 15): A resistor is tied between RT and ground to set the switching frequency.

TR/SS (Pin 16): Output Tracking and Soft-Start Pin. This pin allows user control of output voltage ramp rate during start-up. A TR/SS voltage below 0.97V forces the LT8640/LT8640-1 to regulate the FB pin to equal the TR/SS pin voltage. When TR/SS is above 0.97V, the tracking function is disabled and the internal reference resumes control of the error amplifier. An internal 1.9 μ A pull-up current from INTV_{CC} on this pin allows a capacitor to program output voltage slew rate. This pin is pulled to ground with an internal 200 Ω MOSFET during shutdown and fault conditions; use a series resistor if driving from a low impedance output. This pin may be left floating if the tracking function is not needed.

SYNC/MODE (Pin 17, LT8640 Only): This pin programs four different operating modes: 1) Burst Mode operation. Tie this pin to ground for Burst Mode operation at low output loads—this will result in ultralow quiescent current. 2) Pulse-skipping mode. This mode offers full frequency operation down to low output loads before pulse skipping occurs. Float this pin for pulse-skipping mode. When floating, pin leakage currents should be <1 μ A. See Block

PIN FUNCTIONS

Diagram for internal pull-up and pull-down resistance. 3) Spread spectrum mode. Tie this pin high to $INTV_{CC}$ (~3.4V) or an external supply of 3V to 4V for pulse-skipping mode with spread spectrum modulation. 4) Synchronization mode. Drive this pin with a clock source to synchronize to an external frequency. During synchronization the part will operate in pulse-skipping mode.

SYNC/MODE (Pin 17, LT8640-1 Only): For the LT8640-1, this pin programs four different operating modes: 1) Burst Mode operation. Tie this pin to ground for Burst Mode operation at low output loads—this will result in ultralow quiescent current. 2) Forced Continuous mode (FCM). This mode offers fast transient response and full frequency operation over a wide load range. Float this pin for FCM. When floating, pin leakage currents should be $<1\mu A$. 3) Spread spectrum mode. Tie this pin high to $INTV_{CC}$ (~3.4V) or an external supply of 3V to 4V for forced continuous mode with spread-spectrum modulation. 4) Synchronization mode. Drive this pin with a clock source to synchronize to an external frequency.

During synchronization the part will operate in forced continuous mode.

GND (Pins 18): LT8640/LT8640-1 Ground Pin. Connect this pin to system ground and to the ground plane.

PG (Pin 19): The PG pin is the open-drain output of an internal comparator. PG remains low until the FB pin is within $\pm 8\%$ of the final regulation voltage, and there are no fault conditions. PG is valid when V_{IN} is above 3.4V, regardless of EN/UV pin state.

FB (Pin 20): The LT8640/LT8640-1 regulates the FB pin to 0.970V. Connect the feedback resistor divider tap to this pin. Also, connect a phase lead capacitor between FB and V_{OUT} . Typically, this capacitor is 4.7pF to 22pF.

SW (Exposed Pad Pins 21, 22): The exposed pads should be connected and soldered to the SW trace for good thermal performance. If necessary due to manufacturing limitations Pins 21 and 22 may be left disconnected, however thermal performance will be degraded.

BLOCK DIAGRAM

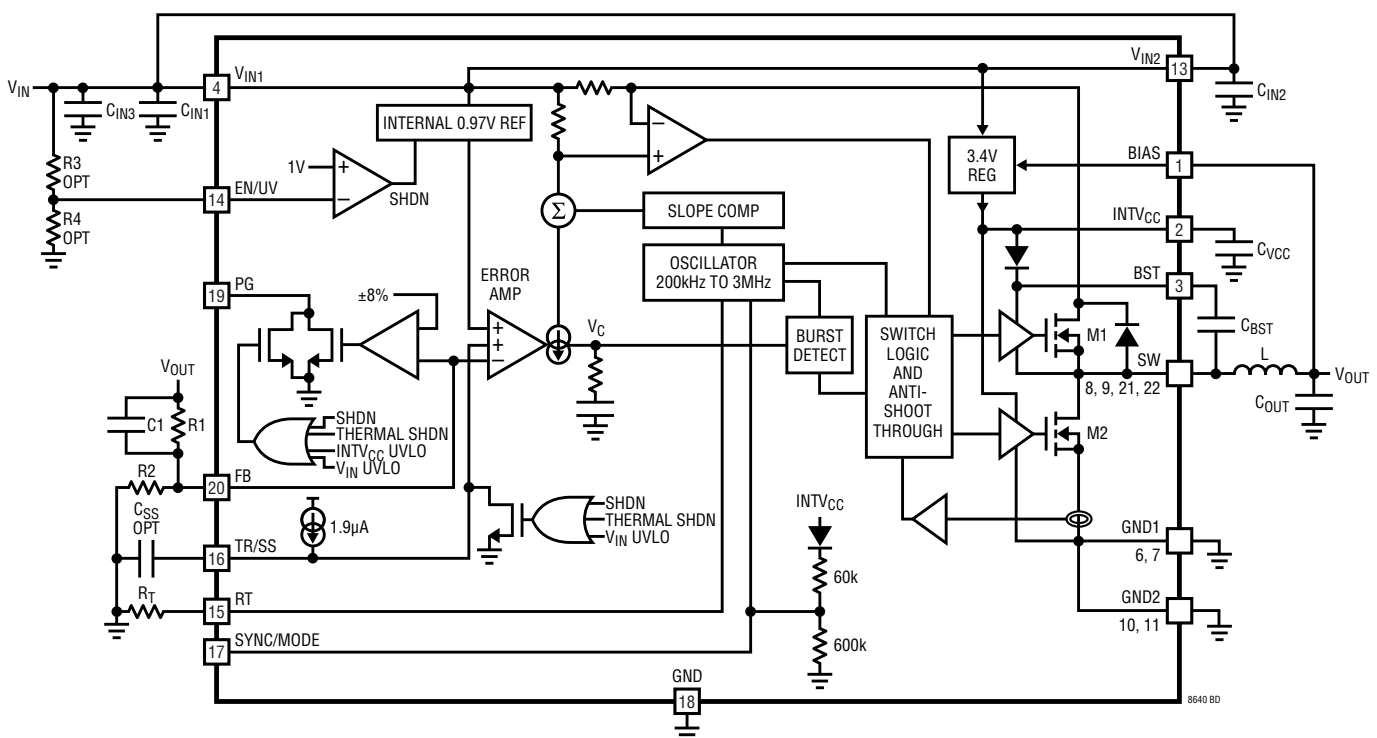

OPERATION

The LT8640/LT8640-1 is a monolithic, constant frequency, current mode step-down DC/DC converter. An oscillator, with frequency set using a resistor on the RT pin, turns on the internal top power switch at the beginning of each clock cycle. Current in the inductor then increases until the top switch current comparator trips and turns off the top power switch. The peak inductor current at which the top switch turns off is controlled by the voltage on the internal VC node. The error amplifier servos the VC node by comparing the voltage on the V_{FB} pin with an internal 0.97V reference. When the load current increases it causes a reduction in the feedback voltage relative to the reference leading the error amplifier to raise the VC voltage until the average inductor current matches the new load current. When the top power switch turns off, the synchronous power switch turns on until the next clock cycle begins or inductor current falls to zero. If overload conditions result in more than 10A flowing through the bottom switch, the next clock cycle will be delayed until switch current returns to a safe level.

If the EN/UV pin is low, the LT8640/LT8640-1 is shut down and draws 1 μ A from the input. When the EN/UV pin is above 1V, the switching regulator will become active.

To optimize efficiency at light loads, the LT8640/LT8640-1 operates in Burst Mode operation in light load situations. Between bursts, all circuitry associated with controlling the output switch is shut down, reducing the input supply current to 1.7 μ A. In a typical application, 2.5 μ A will be consumed from the input supply when regulating with no load. The SYNC/MODE pin is tied low to use Burst Mode operation and can be floated to use pulse-skipping mode (LT8640) or forced continuous mode (FCM) (LT8640-1). If a clock is applied to the SYNC/MODE pin, the part will synchronize to an external clock frequency and operate in either pulse-skipping mode (LT8640) or FCM (LT8640-1).

While in pulse-skipping mode (LT8640 only), the oscillator operates continuously and positive SW transitions are aligned to the clock. During light loads, switch pulses are skipped to regulate the output and the quiescent current will be several hundred μ A.

The LT8640-1 can operate in forced continuous mode (FCM) for fast transient response and full frequency operation over a wide load range. When in FCM the oscillator operates continuously and positive SW transitions are aligned to the clock. Negative inductor current is allowed. The LT8640-1 can sink current from the output and return this charge to the input in this mode, improving load step transient response.

To improve EMI, the LT8640/LT8640-1 can operate in spread spectrum mode. This feature varies the clock with a triangular frequency modulation of +20%. For example, if the LT8640/LT8640-1's frequency is programmed to switch at 2MHz, spread spectrum mode will modulate the oscillator between 2MHz and 2.4MHz. The SYNC/MODE pin should be tied high to INTV_{CC} (~3.4V) or an external supply of 3V to 4V to enable spread spectrum modulation with either pulse-skipping mode (LT8640) or forced continuous mode (LT8640-1).

To improve efficiency across all loads, supply current to internal circuitry can be sourced from the BIAS pin when biased at 3.3V or above. Else, the internal circuitry will draw current from V_{IN}. The BIAS pin should be connected to V_{OUT} if the LT8640/LT8640-1 output is programmed at 3.3V to 25V.

Comparators monitoring the FB pin voltage will pull the PG pin low if the output voltage varies more than $\pm 8\%$ (typical) from the set point, or if a fault condition is present.

The oscillator reduces the LT8640/LT8640-1's operating frequency when the voltage at the FB pin is low. This frequency foldback helps to control the inductor current when the output voltage is lower than the programmed value which occurs during start-up or overcurrent conditions. When a clock is applied to the SYNC/MODE pin, the SYNC/MODE pin is floated, or held DC high, the frequency foldback is disabled and the switching frequency will slow down only during overcurrent conditions.

APPLICATIONS INFORMATION

Low EMI PCB Layout

The LT8640/LT8640-1 is specifically designed to minimize EMI emissions and also to maximize efficiency when switching at high frequencies. For optimal performance the LT8640/LT8640-1 requires the use of multiple V_{IN} bypass capacitors.

Two small $1\mu\text{F}$ capacitors should be placed as close as possible to the LT8640/LT8640-1: One capacitor should be tied to $V_{IN1}/\text{GND1}$; a second capacitor should be tied to $V_{IN2}/\text{GND2}$. A third capacitor with a larger value, $2.2\mu\text{F}$ or higher, should be placed near V_{IN1} or V_{IN2} .

See Figure 1 for a recommended PCB layout.

For more detail and PCB design files refer to the Demo Board guide for the LT8640/LT8640-1.

Note that large, switched currents flow in the LT8640/LT8640-1 V_{IN1} , V_{IN2} , GND1 , and GND2 pins and the input capacitors (C_{IN1} , C_{IN2}). The loops formed by the input capacitors should be as small as possible by placing the capacitors adjacent to the $V_{IN1/2}$ and GND1/2 pins. Capacitors with small case size such as 0603 are optimal due to lowest parasitic inductance.

The input capacitors, along with the inductor and output capacitors, should be placed on the same side of the circuit board, and their connections should be made on that layer. Place a local, unbroken ground plane under the application circuit on the layer closest to the surface layer. The SW and BOOST nodes should be as small as possible. Finally, keep the FB and RT nodes small so that the ground traces will shield them from the SW and BOOST nodes.

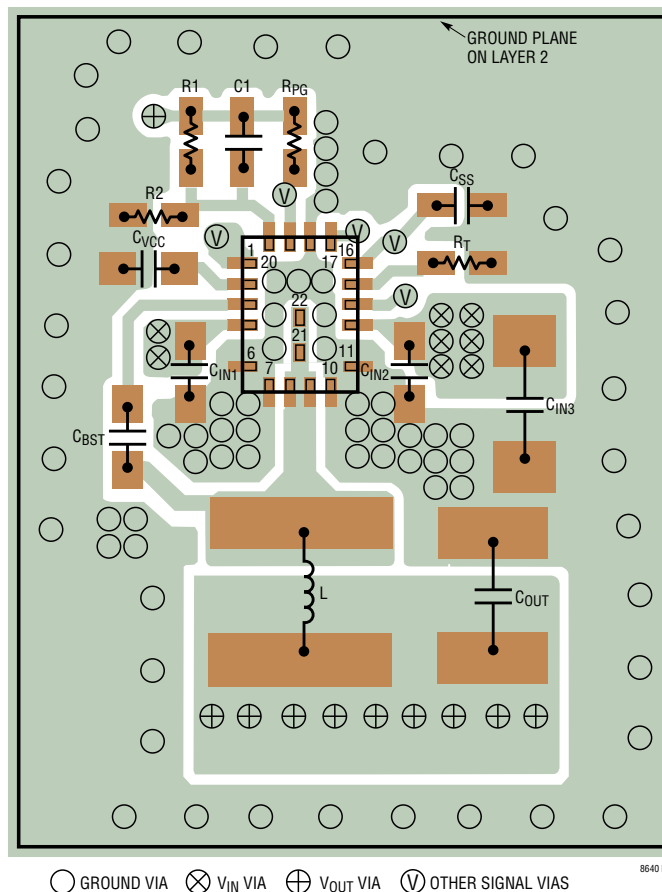

Figure 1. Recommended PCB Layout for the LT8640/LT8640-1

APPLICATIONS INFORMATION

The exposed pad on the bottom of the package should be soldered to SW to reduce thermal resistance to ambient. To keep thermal resistance low, extend the ground plane from GND1 and GND2 as much as possible, and add thermal vias to additional ground planes within the circuit board and on the bottom side.

Achieving Ultralow Quiescent Current (Burst Mode Operation)

To enhance efficiency at light loads, the LT8640/LT8640-1 operates in low ripple Burst Mode operation, which keeps the output capacitor charged to the desired output voltage while minimizing the input quiescent current and minimizing output voltage ripple. In Burst Mode operation the LT8640/LT8640-1 delivers single small pulses of current to the output capacitor followed by sleep periods where the output power is supplied by the output capacitor. While in sleep mode the LT8640/LT8640-1 consumes 1.7 μ A.

As the output load decreases, the frequency of single current pulses decreases (see Figure 2a) and the percentage

of time the LT8640/LT8640-1 is in sleep mode increases, resulting in much higher light load efficiency than for typical converters. By maximizing the time between pulses, the converter quiescent current approaches 2.5 μ A for a typical application when there is no output load. Therefore, to optimize the quiescent current performance at light loads, the current in the feedback resistor divider must be minimized as it appears to the output as load current.

In order to achieve higher light load efficiency, more energy must be delivered to the output during the single small pulses in Burst Mode operation such that the LT8640/LT8640-1 can stay in sleep mode longer between each pulse. This can be achieved by using a larger value inductor (i.e., 4.7 μ H), and should be considered independent of switching frequency when choosing an inductor. For example, while a lower inductor value would typically be used for a high switching frequency application, if high light load efficiency is desired, a higher inductor value should be chosen. See curve in Typical Performance Characteristics.

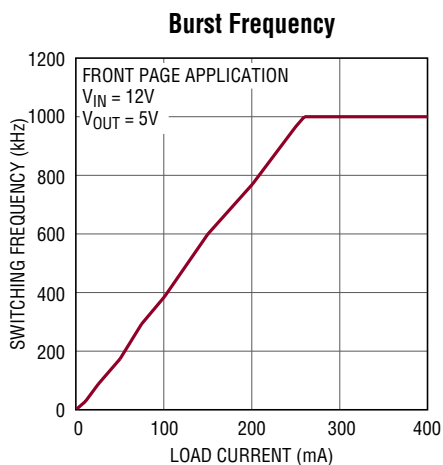

(2a)

Minimum Load to Full Frequency (Pulse-Skipping Mode)

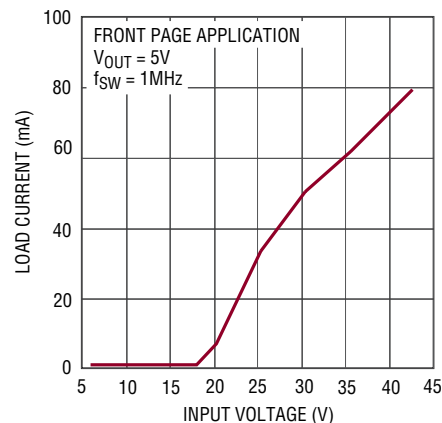

(2b)

Figure 2. SW Frequency vs Load Information in Burst Mode Operation (2a) and Pulse-Skipping Mode (2b)

APPLICATIONS INFORMATION

While in Burst Mode operation the current limit of the top switch is approximately 900mA (as shown in Figure 3), resulting in low output voltage ripple. Increasing the output capacitance will decrease output ripple proportionally. As load ramps upward from zero the switching frequency will increase but only up to the switching frequency programmed by the resistor at the RT pin as shown in Figure 2a.

The output load at which the LT8640/LT8640-1 reaches the programmed frequency varies based on input voltage, output voltage and inductor choice. To select low ripple Burst Mode operation, tie the SYNC/MODE pin below 0.4V (this can be ground or a logic low output).

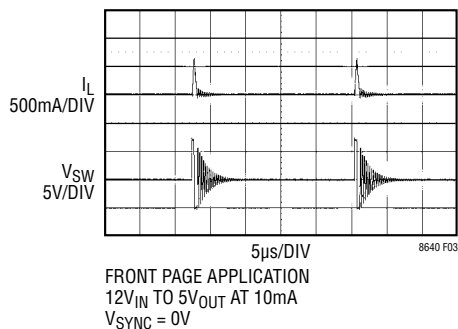

Figure 3. Burst Mode Operation

Pulse-Skipping Mode (LT8640 Only)

For some applications, it is desirable for the LT8640 to operate in pulse-skipping mode, offering two major differences from Burst Mode operation. First is the clock stays awake at all times and all switching cycles are aligned to the clock. In this mode, much of the internal circuitry is awake at all times, increasing quiescent current to several hundred μ A. Second is that full switching frequency is reached at lower output load than in Burst Mode operation (see Figure 2b). To enable pulse-skipping mode (LT8640 only), float the SYNC/MODE pin. Leakage current on this pin should be $<1\mu$ A. See Block Diagram for internal pull-up and pull-down resistance.

Forced Continuous Mode (LT8640-1 Only)

The LT8640-1 can operate in forced continuous mode (FCM) for fast transient response and full frequency operation over a wide load range. When in FCM, the oscillator operates continuously and positive SW transitions are aligned to the clock. Negative inductor current is allowed at light loads or under large transient conditions. The LT8640-1 can sink current from the output and return this charge to the input in this mode, improving load step transient response (see Figure 4). At light loads, FCM operation is less efficient than Burst Mode operation or pulse-skipping mode, but may be desirable in applications where it is necessary to keep switching harmonics out of the signal band. FCM must be used if the output is required to sink current. To enable FCM (LT8640-1 only), float the SYNC/MODE pin. Leakage current on this pin should be $<1\mu$ A. See Block Diagram for internal pull-up and pull-down resistance.

FCM is disabled if the V_{IN} pin is held above 37V or if the FB pin is held greater than 8% above the feedback reference voltage. FCM is also disabled during soft-start until the soft-start capacitor is fully charged. When FCM is disabled in these ways, negative inductor current is not allowed and the LT8640-1 operates in pulse-skipping mode.

For robust operation over a wide V_{IN} and V_{OUT} range, use an inductor value greater than L_{MIN} :

$$L_{MIN} = \frac{V_{OUT}}{2 \cdot f_{SW}} \cdot \left(1 - \frac{V_{OUT}}{40} \right)$$

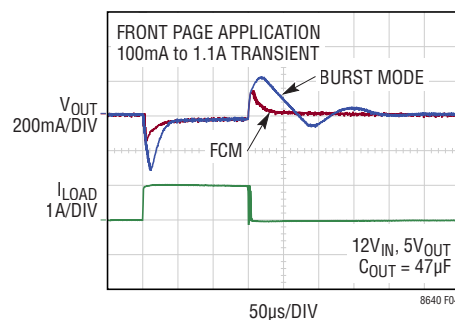

Figure 4. Load Step Transient Response with and without Forced Continuous Mode

APPLICATIONS INFORMATION

Spread Spectrum Mode

The LT8640/LT8640-1 features spread spectrum operation to further reduce EMI emissions. To enable spread spectrum operation, the SYNC/MODE pin should be tied high to INTV_{CC} (~3.4V) or an external supply of 3V to 4V. In this mode, triangular frequency modulation is used to vary the switching frequency between the value programmed by RT to approximately 20% higher than that value. The modulation frequency is approximately 3kHz. For example, when the LT8640/LT8640-1 is programmed to 2MHz, the frequency will vary from 2MHz to 2.4MHz at a 3kHz rate. When spread spectrum operation is selected, Burst Mode operation is disabled, and the part will run in either pulse-skipping mode (LT8640) or forced continuous mode (LT8640-1).

Synchronization

To synchronize the LT8640/LT8640-1 oscillator to an external frequency, connect a square wave (with 20% to 80% duty cycle) to the SYNC/MODE pin. The square wave amplitude should have valleys that are below 0.4V and peaks above 1.5V (up to 6V).

The LT8640/LT8640-1 will not enter Burst Mode operation at low output loads while synchronized to an external clock, but instead will pulse-skip (LT8640) or run forced continuous mode (LT8640-1) to maintain regulation. The LT8640/LT8640-1 may be synchronized over a 200kHz to 3MHz range. The RT resistor should be chosen to set the LT8640/LT8640-1 switching frequency equal to or below the lowest synchronization input. For example, if the synchronization signal will be 500kHz and higher, the RT should be selected for 500kHz. The slope compensation is set by the RT value, while the minimum slope compensation required to avoid subharmonic oscillations is established by the inductor size, input voltage and output voltage. Since the synchronization frequency will not change the slopes of the inductor current waveform, if the inductor is large enough to avoid subharmonic oscillations at the frequency set by RT, then the slope compensation will be sufficient for all synchronization frequencies.

FB Resistor Network

The output voltage is programmed with a resistor divider between the output and the FB pin. Choose the resistor values according to:

$$R1 = R2 \left(\frac{V_{OUT}}{0.970V} - 1 \right) \quad (1)$$

Reference designators refer to the Block Diagram. 1% resistors are recommended to maintain output voltage accuracy.

If low input quiescent current and good light-load efficiency are desired, use large resistor values for the FB resistor divider. The current flowing in the divider acts as a load current, and will increase the no-load input current to the converter, which is approximately:

$$I_Q = 1.7\mu A + \left(\frac{V_{OUT}}{R1+R2} \right) \left(\frac{V_{OUT}}{V_{IN}} \right) \left(\frac{1}{n} \right) \quad (2)$$

where 1.7μA is the quiescent current of the LT8640/LT8640-1 and the second term is the current in the feedback divider reflected to the input of the buck operating at its light load efficiency n. For a 3.3V application with R1 = 1M and R2 = 412k, the feedback divider draws 2.3μA. With V_{IN} = 12V and n = 80%, this adds 0.8μA to the 1.7μA quiescent current resulting in 2.5μA no-load current from the 12V supply. Note that this equation implies that the no-load current is a function of V_{IN}; this is plotted in the Typical Performance Characteristics section.

When using large FB resistors, a 4.7pF to 22pF phase-lead capacitor should be connected from V_{OUT} to FB.

APPLICATIONS INFORMATION

Setting the Switching Frequency

The LT8640/LT8640-1 uses a constant frequency PWM architecture that can be programmed to switch from 200kHz to 3MHz by using a resistor tied from the RT pin to ground. A table showing the necessary R_T value for a desired switching frequency is in Table 1.

The R_T resistor required for a desired switching frequency can be calculated using:

$$R_T = \frac{46.5}{f_{SW}} - 5.2 \quad (3)$$

where R_T is in $k\Omega$ and f_{SW} is the desired switching frequency in MHz.

Table 1. SW Frequency vs R_T Value

f_{SW} (MHz)	R_T ($k\Omega$)
0.2	232
0.3	150
0.4	110
0.5	88.7
0.6	71.5
0.7	60.4
0.8	52.3
1.0	41.2
1.2	33.2
1.4	28.0
1.6	23.7
1.8	20.5
2.0	18.2
2.2	15.8
3.0	10.7

Operating Frequency Selection and Trade-Offs

Selection of the operating frequency is a trade-off between efficiency, component size, and input voltage range. The advantage of high frequency operation is that smaller inductor and capacitor values may be used. The disadvantages are lower efficiency and a smaller input voltage range.

The highest switching frequency ($f_{SW(MAX)}$) for a given application can be calculated as follows:

$$f_{SW(MAX)} = \frac{V_{OUT} + V_{SW(BOT)}}{t_{ON(MIN)}(V_{IN} - V_{SW(TOP)} + V_{SW(BOT)})} \quad (4)$$

where V_{IN} is the typical input voltage, V_{OUT} is the output voltage, $V_{SW(TOP)}$ and $V_{SW(BOT)}$ are the internal switch drops (~0.4V, ~0.15V, respectively at maximum load) and $t_{ON(MIN)}$ is the minimum top switch on-time (see the Electrical Characteristics). This equation shows that a slower switching frequency is necessary to accommodate a high V_{IN}/V_{OUT} ratio.

For transient operation, V_{IN} may go as high as the absolute maximum rating of 42V regardless of the R_T value, however the LT8640/LT8640-1 will reduce switching frequency as necessary to maintain control of inductor current to assure safe operation.

The LT8640/LT8640-1 is capable of a maximum duty cycle of approximately 99%, and the V_{IN} -to- V_{OUT} dropout is limited by the $R_{DS(ON)}$ of the top switch. In this mode the LT8640/LT8640-1 skips switch cycles, resulting in a lower switching frequency than programmed by R_T .

For applications that cannot allow deviation from the programmed switching frequency at low V_{IN}/V_{OUT} ratios use the following formula to set switching frequency:

$$V_{IN(MIN)} = \frac{V_{OUT} + V_{SW(BOT)}}{1 - f_{SW} \cdot t_{OFF(MIN)}} - V_{SW(BOT)} + V_{SW(TOP)} \quad (5)$$

where $V_{IN(MIN)}$ is the minimum input voltage without skipped cycles, V_{OUT} is the output voltage, $V_{SW(TOP)}$ and $V_{SW(BOT)}$ are the internal switch drops (~0.4V, ~0.15V, respectively at maximum load), f_{SW} is the switching frequency (set by R_T), and $t_{OFF(MIN)}$ is the minimum switch off-time. Note that higher switching frequency will increase the minimum input voltage below which cycles will be dropped to achieve higher duty cycle.

APPLICATIONS INFORMATION

Inductor Selection and Maximum Output Current

The LT8640/LT8640-1 is designed to minimize solution size by allowing the inductor to be chosen based on the output load requirements of the application. During overload or short-circuit conditions the LT8640/LT8640-1 safely tolerates operation with a saturated inductor through the use of a high speed peak-current mode architecture.

A good first choice for the inductor value is:

$$L = \left(\frac{V_{OUT} + V_{SW(BOT)}}{f_{SW}} \right) \cdot 0.7 \quad (6)$$

where f_{SW} is the switching frequency in MHz, V_{OUT} is the output voltage, $V_{SW(BOT)}$ is the bottom switch drop ($\sim 0.15V$) and L is the inductor value in μH .

To avoid overheating and poor efficiency, an inductor must be chosen with an RMS current rating that is greater than the maximum expected output load of the application. In addition, the saturation current (typically labeled I_{SAT}) rating of the inductor must be higher than the load current plus 1/2 of in inductor ripple current:

$$I_{L(PEAK)} = I_{LOAD(MAX)} + \frac{1}{2} \Delta I_L \quad (7)$$

where ΔI_L is the inductor ripple current as calculated in Equation 9 and $I_{LOAD(MAX)}$ is the maximum output load for a given application.

As a quick example, an application requiring 3A output should use an inductor with an RMS rating of greater than 3A and an I_{SAT} of greater than 4A. During long duration overload or short-circuit conditions, the inductor RMS rating requirement is greater to avoid overheating of the inductor. To keep the efficiency high, the series resistance (DCR) should be less than 0.02Ω , and the core material should be intended for high frequency applications.

The LT8640/LT8640-1 limits the peak switch current in order to protect the switches and the system from overload faults. The top switch current limit (I_{LIM}) is 10A at low duty cycles and decreases linearly to 7A at $DC = 0.8$. The inductor value must then be sufficient to supply the desired maximum output current ($I_{OUT(MAX)}$), which is a function of the switch current limit (I_{LIM}) and the ripple current.

$$I_{OUT(MAX)} = I_{LIM} - \frac{\Delta I_L}{2} \quad (8)$$

The peak-to-peak ripple current in the inductor can be calculated as follows:

$$\Delta I_L = \frac{V_{OUT}}{L \cdot f_{SW}} \cdot \left(1 - \frac{V_{OUT}}{V_{IN(MAX)}} \right) \quad (9)$$

where f_{SW} is the switching frequency of the LT8640/LT8640-1, and L is the value of the inductor. Therefore, the maximum output current that the LT8640/LT8640-1 will deliver depends on the switch current limit, the inductor value, and the input and output voltages. The inductor value may have to be increased if the inductor ripple current does not allow sufficient maximum output current ($I_{OUT(MAX)}$) given the switching frequency, and maximum input voltage used in the desired application.

In order to achieve higher light load efficiency, more energy must be delivered to the output during the single small pulses in Burst Mode operation such that the LT8640/LT8640-1 can stay in sleep mode longer between each pulse. This can be achieved by using a larger value inductor (i.e., $4.7\mu H$), and should be considered independent of switching frequency when choosing an inductor. For example, while a lower inductor value would typically be used for a high switching frequency application, if high light load efficiency is desired, a higher inductor value should be chosen. See curve in Typical Performance Characteristics.

APPLICATIONS INFORMATION

The optimum inductor for a given application may differ from the one indicated by this design guide. A larger value inductor provides a higher maximum load current and reduces the output voltage ripple. For applications requiring smaller load currents, the value of the inductor may be lower and the LT8640/LT8640-1 may operate with higher ripple current. This allows use of a physically smaller inductor, or one with a lower DCR resulting in higher efficiency. Be aware that low inductance may result in discontinuous mode operation, which further reduces maximum load current.

For more information about maximum output current and discontinuous operation, see ADI's Application Note 44.

For duty cycles greater than 50% ($V_{OUT}/V_{IN} > 0.5$), a minimum inductance is required to avoid subharmonic oscillation (See Equation 10). See Application Note 19 for more details.

$$L_{MIN} = \frac{V_{IN}(2 \cdot DC - 1)}{3.5 \cdot f_{SW}} \quad (10)$$

where DC is the duty cycle ratio (V_{OUT}/V_{IN}) and f_{SW} is the switching frequency.

Input Capacitors

The V_{IN} of the LT8640/LT8640-1 should be bypassed with at least three ceramic capacitors for best performance. Two small ceramic capacitors of 1 μ F should be placed close to the part; one at the $V_{IN1}/GND1$ pins and a second at $V_{IN2}/GND2$ pins. These capacitors should be 0402 or 0603 in size. For automotive applications requiring 2 series input capacitors, two small 0402 or 0603 may be placed at each side of the LT8640/LT8640-1 near the $V_{IN1}/GND1$ and $V_{IN2}/GND2$ pins.

A third, larger ceramic capacitor of 2.2 μ F or larger should be placed close to V_{IN1} or V_{IN2} . See layout section for more detail. X7R or X5R capacitors are recommended for best performance across temperature and input voltage variations.

Note that larger input capacitance is required when a lower switching frequency is used. If the input power source has

high impedance, or there is significant inductance due to long wires or cables, additional bulk capacitance may be necessary. This can be provided with a low performance electrolytic capacitor.

A ceramic input capacitor combined with trace or cable inductance forms a high quality (under damped) tank circuit. If the LT8640/LT8640-1 circuit is plugged into a live supply, the input voltage can ring to twice its nominal value, possibly exceeding the LT8640/LT8640-1's voltage rating. This situation is easily avoided (see ADI Application Note 88).

Output Capacitor and Output Ripple

The output capacitor has two essential functions. Along with the inductor, it filters the square wave generated by the LT8640/LT8640-1 to produce the DC output. In this role it determines the output ripple, thus low impedance at the switching frequency is important. The second function is to store energy in order to satisfy transient loads and stabilize the LT8640/LT8640-1's control loop. Ceramic capacitors have very low equivalent series resistance (ESR) and provide the best ripple performance. For good starting values, see the Typical Applications section.

Use X5R or X7R types. This choice will provide low output ripple and good transient response. Transient performance can be improved with a higher value output capacitor and the addition of a feedforward capacitor placed between V_{OUT} and FB. Increasing the output capacitance will also decrease the output voltage ripple. A lower value of output capacitor can be used to save space and cost but transient performance will suffer and may cause loop instability. See the Typical Applications in this data sheet for suggested capacitor values.

When choosing a capacitor, special attention should be given to the data sheet to calculate the effective capacitance under the relevant operating conditions of voltage bias and temperature. A physically larger capacitor or one with a higher voltage rating may be required.

APPLICATIONS INFORMATION

Ceramic Capacitors

Ceramic capacitors are small, robust and have very low ESR. However, ceramic capacitors can cause problems when used with the LT8640/LT8640-1 due to their piezoelectric nature. When in Burst Mode operation, the LT8640/LT8640-1's switching frequency depends on the load current, and at very light loads the LT8640/LT8640-1 can excite the ceramic capacitor at audio frequencies, generating audible noise. Since the LT8640/LT8640-1 operates at a lower current limit during Burst Mode operation, the noise is typically very quiet to a casual ear. If this is unacceptable, use a high performance tantalum or electrolytic capacitor at the output. Low noise ceramic capacitors are also available.

A final precaution regarding ceramic capacitors concerns the maximum input voltage rating of the LT8640/LT8640-1. As previously mentioned, a ceramic input capacitor combined with trace or cable inductance forms a high quality (underdamped) tank circuit. If the LT8640/LT8640-1 circuit is plugged into a live supply, the input voltage can ring to twice its nominal value, possibly exceeding the LT8640/LT8640-1's rating. This situation is easily avoided (see ADI Note 88).

Enable Pin

The LT8640/LT8640-1 is in shutdown when the EN pin is low and active when the pin is high. The rising threshold of the EN comparator is 1.0V, with 40mV of hysteresis. The EN pin can be tied to V_{IN} if the shutdown feature is not used, or tied to a logic level if shutdown control is required.

Adding a resistor divider from V_{IN} to EN programs the LT8640/LT8640-1 to regulate the output only when V_{IN} is above a desired voltage (see the Block Diagram). Typically, this threshold, $V_{IN(EN)}$, is used in situations where the input supply is current limited, or has a relatively high source resistance. A switching regulator draws constant power from the source, so source current increases as source voltage drops. This looks like a negative resistance load to the source and can cause the source to current limit or

latch low under low source voltage conditions. The $V_{IN(EN)}$ threshold prevents the regulator from operating at source voltages where the problems might occur. This threshold can be adjusted by setting the values R3 and R4 such that they satisfy the following equation:

$$V_{IN(EN)} = \left(\frac{R3}{R4} + 1 \right) \cdot 1.0V \quad (11)$$

where the LT8640/LT8640-1 will remain off until V_{IN} is above $V_{IN(EN)}$. Due to the comparator's hysteresis, switching will not stop until the input falls slightly below $V_{IN(EN)}$.

When operating in Burst Mode operation for light load currents, the current through the $V_{IN(EN)}$ resistor network can easily be greater than the supply current consumed by the LT8640/LT8640-1. Therefore, the $V_{IN(EN)}$ resistors should be large to minimize their effect on efficiency at low loads.

INTV_{CC} Regulator

An internal low dropout (LDO) regulator produces the 3.4V supply from V_{IN} that powers the drivers and the internal bias circuitry. The INTV_{CC} can supply enough current for the LT8640/LT8640-1's circuitry and must be bypassed to ground with a minimum of 1μF ceramic capacitor. Good bypassing is necessary to supply the high transient currents required by the power MOSFET gate drivers. To improve efficiency the internal LDO can also draw current from the BIAS pin when the BIAS pin is at 3.1V or higher. Typically the BIAS pin can be tied to the output of the LT8640/LT8640-1, or can be tied to an external supply of 3.3V or above. If BIAS is connected to a supply other than V_{OUT} , be sure to bypass with a local ceramic capacitor. If the BIAS pin is below 3.0V, the internal LDO will consume current from V_{IN} . Applications with high input voltage and high switching frequency where the internal LDO pulls current from V_{IN} will increase die temperature because of the higher power dissipation across the LDO. Do not connect an external load to the INTV_{CC} pin.

APPLICATIONS INFORMATION

Output Voltage Tracking and Soft-Start

The LT8640/LT8640-1 allows the user to program its output voltage ramp rate by means of the TR/SS pin. An internal $1.9\mu\text{A}$ pulls up the TR/SS pin to INTV_{CC} . Putting an external capacitor on TR/SS enables soft starting the output to prevent current surge on the input supply. During the soft-start ramp the output voltage will proportionally track the TR/SS pin voltage. For output tracking applications, TR/SS can be externally driven by another voltage source. From 0V to 0.97V , the TR/SS voltage will override the internal 0.97V reference input to the error amplifier, thus regulating the FB pin voltage to that of TR/SS pin. When TR/SS is above 0.97V , tracking is disabled and the feedback voltage will regulate to the internal reference voltage. The TR/SS pin may be left floating if the function is not needed.

An active pull-down circuit is connected to the TR/SS pin which will discharge the external soft-start capacitor in the case of fault conditions and restart the ramp when the faults are cleared. Fault conditions that clear the soft-start capacitor are the EN/UV pin transitioning low, V_{IN} voltage falling too low, or thermal shutdown.

Output Power Good

When the LT8640/LT8640-1's output voltage is within the $\pm 8\%$ window of the regulation point, the output voltage is considered good and the open-drain PG pin goes high impedance and is typically pulled high with an external resistor. Otherwise, the internal pull-down device will pull the PG pin low. To prevent glitching both the upper and lower thresholds include 0.2% of hysteresis.

The PG pin is also actively pulled low during several fault conditions: EN/UV pin is below 1V , INTV_{CC} has fallen too low, V_{IN} is too low, or thermal shutdown.

Shorted and Reversed Input Protection

The LT8640/LT8640-1 will tolerate a shorted output. Several features are used for protection during output short-circuit and brownout conditions. The first is the switching frequency will be folded back while the output is lower than the set point to maintain inductor current

control. Second, the bottom switch current is monitored such that if inductor current is beyond safe levels switching of the top switch will be delayed until such time as the inductor current falls to safe levels.

Frequency foldback behavior depends on the state of the SYNC pin: If the SYNC pin is low the switching frequency will slow while the output voltage is lower than the programmed level. If the SYNC pin is connected to a clock source, floated or tied high, the LT8640/LT8640-1 will stay at the programmed frequency without foldback and only slow switching if the inductor current exceeds safe levels.

There is another situation to consider in systems where the output will be held high when the input to the LT8640/LT8640-1 is absent. This may occur in battery charging applications or in battery-backup systems where a battery or some other supply is diode ORed with the LT8640/LT8640-1's output. If the V_{IN} pin is allowed to float and the EN pin is held high (either by a logic signal or because it is tied to V_{IN}), then the LT8640/LT8640-1's internal circuitry will pull its quiescent current through its SW pin. This is acceptable if the system can tolerate several μA in this state. If the EN pin is grounded the SW pin current will drop to near $1\mu\text{A}$. However, if the V_{IN} pin is grounded while the output is held high, regardless of EN, parasitic body diodes inside the LT8640/LT8640-1 can pull current from the output through the SW pin and the V_{IN} pin, which may damage the IC. Figure 5 shows a connection of the V_{IN} and EN/UV pins that will allow the LT8640/LT8640-1 to run only when the input voltage is present and that protects against a shorted or reversed input.

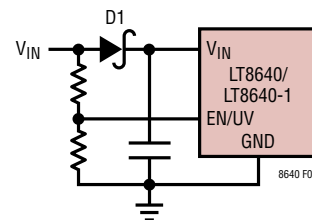

Figure 5. Reverse V_{IN} Protection

APPLICATIONS INFORMATION

Thermal Considerations and Peak Output Current

For higher ambient temperatures, care should be taken in the layout of the PCB to ensure good heat sinking of the LT8640/LT8640-1. The ground pins on the bottom of the package should be soldered to a ground plane. This ground should be tied to large copper layers below with thermal vias; these layers will spread heat dissipated by the LT8640/LT8640-1. Placing additional vias can reduce thermal resistance further. The maximum load current should be derated as the ambient temperature approaches the maximum junction rating. Power dissipation within the LT8640/LT8640-1 can be estimated by calculating the total power loss from an efficiency measurement and subtracting the inductor loss. The die temperature is calculated by multiplying the LT8640/LT8640-1 power dissipation by the thermal resistance from junction to ambient.

The internal overtemperature protection monitors the junction temperature of the LT8640/LT8640-1. If the junction temperature reaches approximately 170°C, the LT8640/LT8640-1 will stop switching and indicate a fault condition until the temperature drops about 10°C cooler.

Temperature rise of the LT8640/LT8640-1 is worst when operating at high load, high V_{IN} , and high switching frequency. If the case temperature is too high for a given application, then either V_{IN} , switching frequency, or load current can be decreased to reduce the temperature to an acceptable level. Figure 6 shows examples of how case temperature rise can be managed by reducing V_{IN} , switching frequency, or load.

The LT8640/LT8640-1's internal power switches are capable of safely delivering up to 7A of peak output current. However, due to thermal limits, the package can only handle 7A loads for short periods of time. This time is determined by how quickly the case temperature approaches the maximum junction rating. Figure 6 shows an example of how case temperature rise changes with the duty cycle of a 1kHz pulsed 7A load.

The LT8640/LT8640-1's top switch current limit decreases with higher duty cycle operation for slope compensation. This also limits the peak output current the LT8640/LT8640-1 can deliver for a given application. See curve in Typical Performance Characteristics.

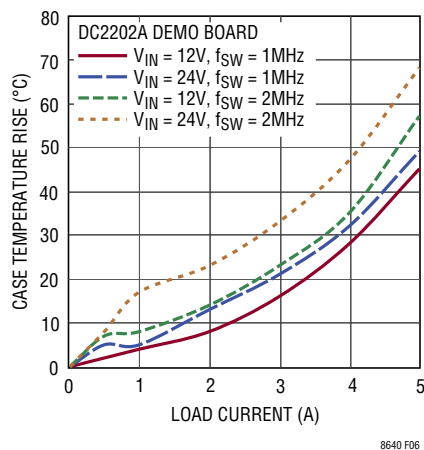

Figure 6. Case Temperature Rise

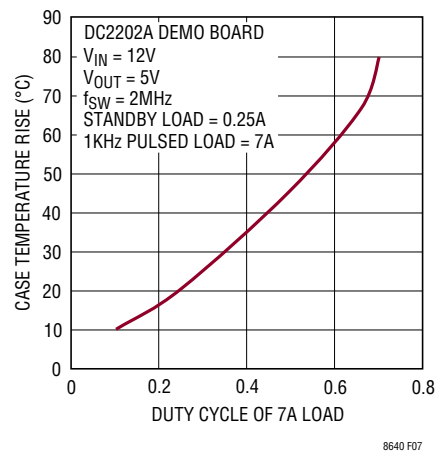
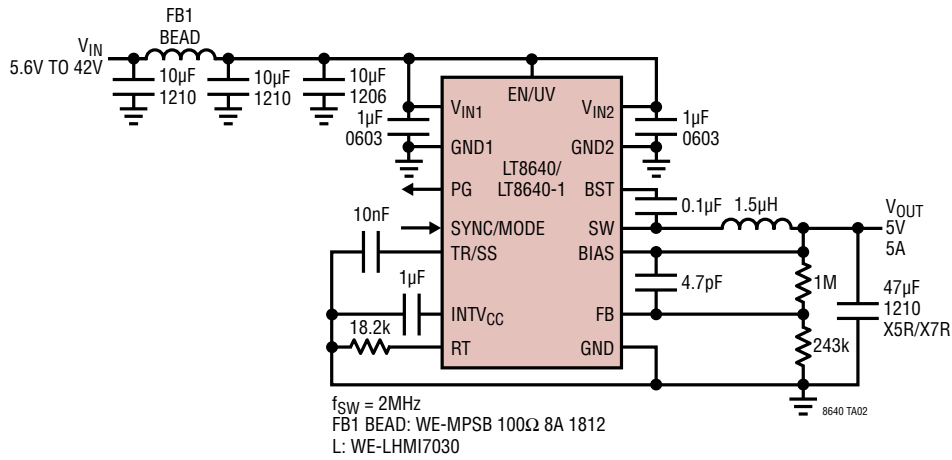

Figure 7. Case Temperature Rise vs 7A Pulsed Load

TYPICAL APPLICATIONS

Ultralow EMI 5V, 5A Step-Down Converter



2MHz 5V, 5A Step-Down Converter

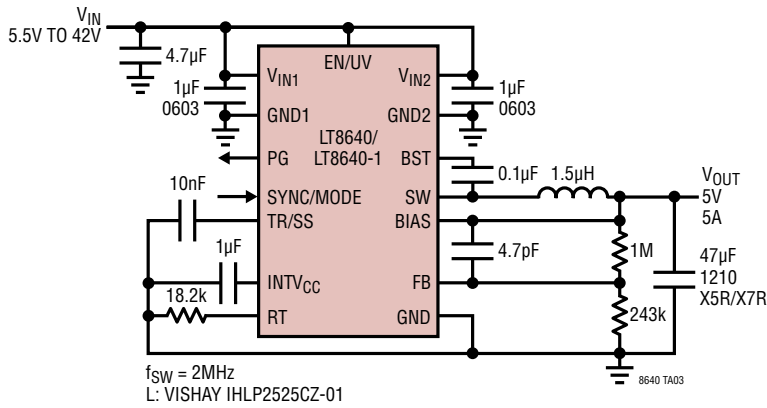

TYPICAL APPLICATIONS

2MHz 3.3V, 5A Step-Down Converter

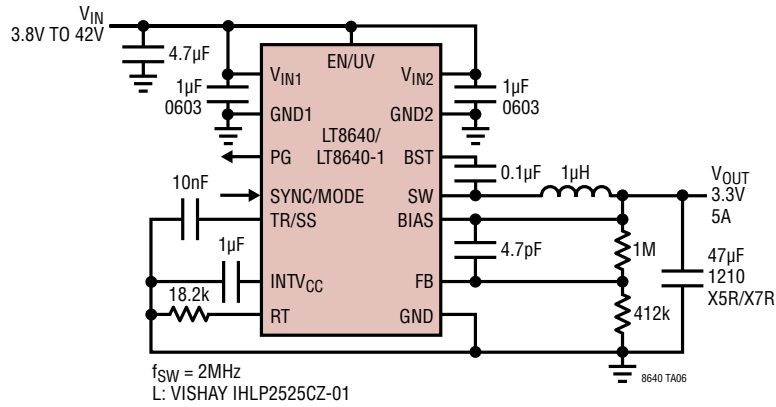

12V, 5A Step-Down Converter

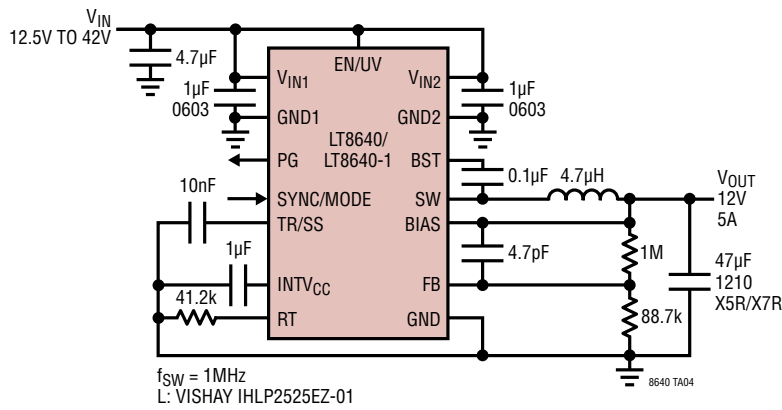

PACKAGE DESCRIPTION

UDC Package
Variation: UDC20(18)
20(18)-Lead Plastic QFN (3mm × 4mm)
 (Reference LTC DWG # 05-08-1956 Rev C)
Exposed Pad Variation AA

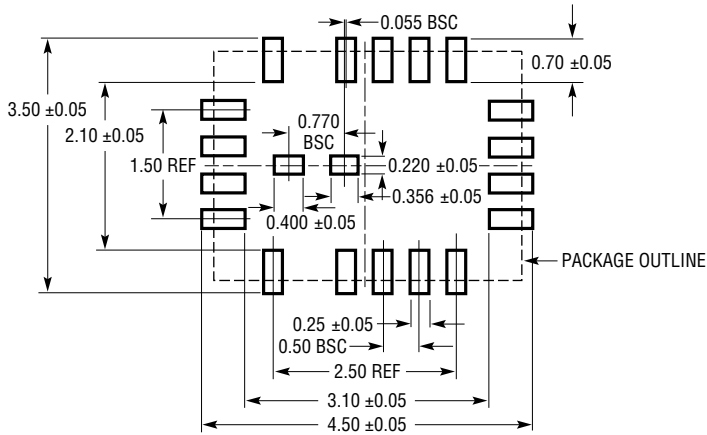

RECOMMENDED SOLDER PAD PITCH AND DIMENSIONS
 APPLY SOLDER MASK TO AREAS THAT ARE NOT SOLDERED

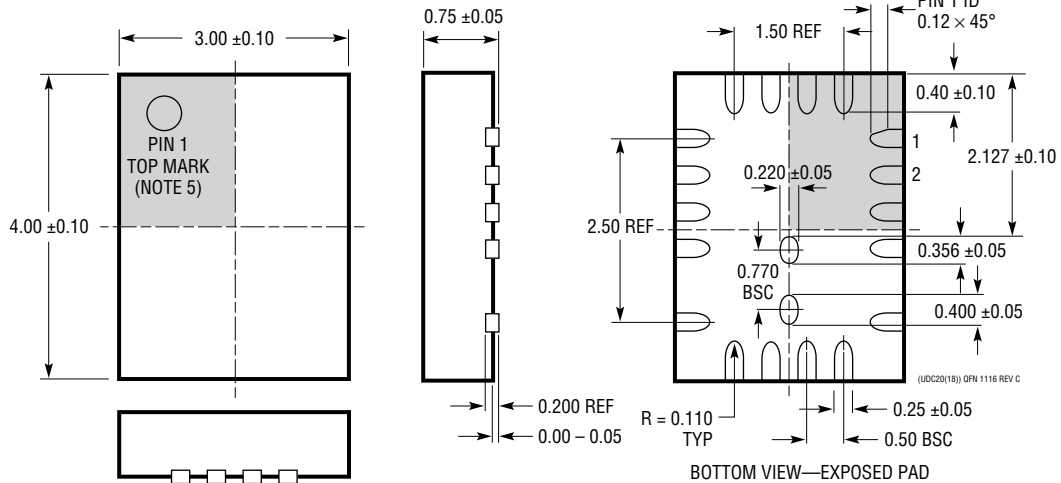

NOTE:

1. DRAWING IS NOT A JEDEC PACKAGE OUTLINE
2. DRAWING NOT TO SCALE
3. ALL DIMENSIONS ARE IN MILLIMETERS
4. DIMENSIONS OF EXPOSED PAD ON BOTTOM OF PACKAGE DO NOT INCLUDE MOLD FLASH. MOLD FLASH, IF PRESENT, SHALL NOT EXCEED 0.15mm ON ANY SIDE
5. SHADED AREA IS ONLY A REFERENCE FOR PIN 1 LOCATION ON THE TOP AND BOTTOM OF PACKAGE

REVISION HISTORY

REV	DATE	DESCRIPTION	PAGE NUMBER
A	10/15	Added LT8640-1 Version to Title. Clarified Minimum On-Time to 35ns. Added LT8640-1 Version. Clarified SYNC/MODE Threshold. Added LT8640-1 Version Specifications. Clarified Minimum Load Graph to Pulse Skipping. Added LT8640-1 Version.	All. 1, 3. 1, 2, 4. 3. 4. 7. 11 to 25
B	01/18	Clarified Efficiency Conditions. Clarified Minimum On-Time to 30ns. Added LT8640HUDC-1. Added New Note 3, Note 3 became Note 4. Clarified Minimum On-Time Graph. Clarified Case Temperature Graph. Clarified SYNC/MODE Pin Description. Clarified Block Drawing. Clarified Operation Section. Clarified Pulse-Skipping Mode Section. Clarified Forced Continuous Mode Section. Clarified Spread Spectrum Mode Section. Clarified Operating Switching Frequency Section. Clarified Inductor Selection and Maximum Output Current Section. Clarified Thermal Considerations and Peak Output Current Section/Graph. Clarified Output Capacitor on Typical Applications. Clarified Inductor on Lower Typical Application.	1. 1,3. 2. 4. 6. 8. 12. 12. 13. 16. 16. 17. 18. 19. 23. 24,25,28. 24
C	02/19	Added Side Wettable Flank QFN Package Option. Added LT8640 Options Table, Reduced Description. Added Side Wettable Flanks Parts. Clarified SYNC/MODE Pin Description. Clarified Figure 1 V_{OUT} VIA. Clarified L_{MIN} Formula. Formula 10 becomes 11. Clarified Shorted and Reversed Input Protection Paragraph. Added Side Wettable Flank QFN Package Option.	1. 1. 2. 12. 14. 20. 21. 22. 28
D	01/20	Added AECQ-100 Statement Under Features. Removed EMC Word. Added LT8640J/LT8640-1J Under Absolute Maximum Ratings. Added LT8640JUDCF and LT8640JUDCF-1 Options to the Order Information Table. Added Automotive Products JUDCF-1#W and JUDCF#W to the Order Information Table. Added Note 2 Under EC Table to Include LT8640J/LT8640J-1.	1. 1, 13,14, 17. 2. 2. 2. 4
E	03/22	Added LT8640HUDCF to the Order Information table.	2

TYPICAL APPLICATION

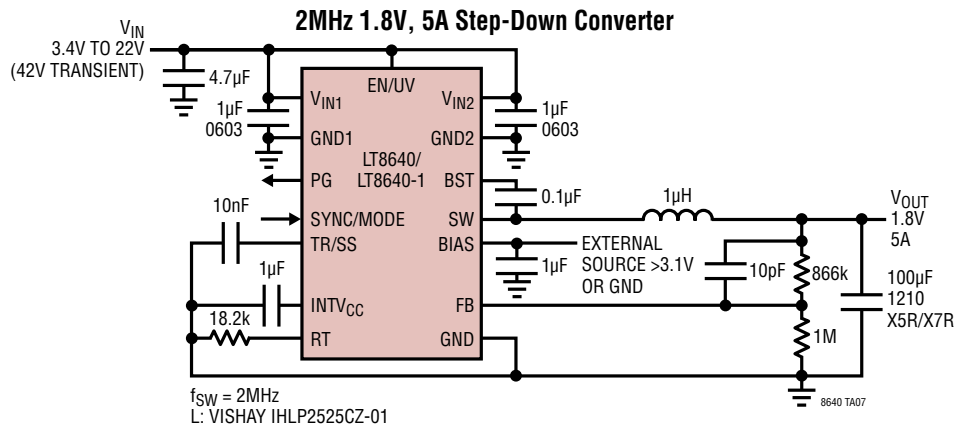

RELATED PARTS

PART	DESCRIPTION	COMMENTS
LT8609	42V, 2A, 94% Efficiency, 2.2MHz Synchronous MicroPower Step-Down DC/DC Converter with $I_Q = 2.5\mu\text{A}$	$V_{IN(MIN)} = 3\text{V}$, $V_{IN(MAX)} = 42\text{V}$, $V_{OUT(MIN)} = 0.8\text{V}$, $I_Q = 2.5\mu\text{A}$, $I_{SD} < 1\mu\text{A}$, MSOP-10E
LT8610A/AB	42V, 3.5A, 96% Efficiency, 2.2MHz Synchronous MicroPower Step-Down DC/DC Converter with $I_Q = 2.5\mu\text{A}$	$V_{IN(MIN)} = 3.4\text{V}$, $V_{IN(MAX)} = 42\text{V}$, $V_{OUT(MIN)} = 0.97\text{V}$, $I_Q = 2.5\mu\text{A}$, $I_{SD} < 1\mu\text{A}$, MSOP-16E
LT8610AC	42V, 3.5A, 96% Efficiency, 2.2MHz Synchronous MicroPower Step-Down DC/DC Converter with $I_Q = 2.5\mu\text{A}$	$V_{IN(MIN)} = 3\text{V}$, $V_{IN(MAX)} = 42\text{V}$, $V_{OUT(MIN)} = 0.8\text{V}$, $I_Q = 2.5\mu\text{A}$, $I_{SD} < 1\mu\text{A}$, MSOP-16E
LT8610	42V, 2.5A, 96% Efficiency, 2.2MHz Synchronous MicroPower Step-Down DC/DC Converter with $I_Q = 2.5\mu\text{A}$	$V_{IN(MIN)} = 3.4\text{V}$, $V_{IN(MAX)} = 42\text{V}$, $V_{OUT(MIN)} = 0.97\text{V}$, $I_Q = 2.5\mu\text{A}$, $I_{SD} < 1\mu\text{A}$, MSOP-16E
LT8611	42V, 2.5A, 96% Efficiency, 2.2MHz Synchronous MicroPower Step-Down DC/DC Converter with $I_Q = 2.5\mu\text{A}$ and Input/Output Current Limit/Monitor	$V_{IN(MIN)} = 3.4\text{V}$, $V_{IN(MAX)} = 42\text{V}$, $V_{OUT(MIN)} = 0.97\text{V}$, $I_Q = 2.5\mu\text{A}$, $I_{SD} < 1\mu\text{A}$, 3mm x 5mm QFN-24
LT8616	42V, Dual 2.5A + 1.5A, 95% Efficiency, 2.2MHz Synchronous MicroPower Step-Down DC/DC Converter with $I_Q = 5\mu\text{A}$	$V_{IN(MIN)} = 3.4\text{V}$, $V_{IN(MAX)} = 42\text{V}$, $V_{OUT(MIN)} = 0.8\text{V}$, $I_Q = 5\mu\text{A}$, $I_{SD} < 1\mu\text{A}$, TSSOP-28E, 3mm x 6mm QFN-28
LT8620	65V, 2.5A, 94% Efficiency, 2.2MHz Synchronous MicroPower Step-Down DC/DC Converter with $I_Q = 2.5\mu\text{A}$	$V_{IN(MIN)} = 3.4\text{V}$, $V_{IN(MAX)} = 65\text{V}$, $V_{OUT(MIN)} = 0.97\text{V}$, $I_Q = 2.5\mu\text{A}$, $I_{SD} < 1\mu\text{A}$, MSOP-16E, 3mm x 5mm QFN-24
LT8614	42V, 4A, 96% Efficiency, 2.2MHz Synchronous Silent Switcher Step-Down DC/DC Converter with $I_Q = 2.5\mu\text{A}$	$V_{IN(MIN)} = 3.4\text{V}$, $V_{IN(MAX)} = 42\text{V}$, $V_{OUT(MIN)} = 0.97\text{V}$, $I_Q = 2.5\mu\text{A}$, $I_{SD} < 1\mu\text{A}$, 3mm x 4mm QFN18
LT3975	42V, 2.5A, High Efficiency, 2MHz MicroPower Step-Down DC/DC Converter with $I_Q = 2.7\mu\text{A}$	$V_{IN(MIN)} = 4.3\text{V}$, $V_{IN(MAX)} = 42\text{V}$, $V_{OUT(MIN)} = 1.2\text{V}$, $I_Q = 2.7\mu\text{A}$, $I_{SD} < 1\mu\text{A}$, MSOP-16E
LT3976	40V, 5A, High Efficiency, 2MHz MicroPower Step-Down DC/DC Converter with $I_Q = 3.3\mu\text{A}$	$V_{IN(MIN)} = 4.3\text{V}$, $V_{IN(MAX)} = 40\text{V}$, $V_{OUT(MIN)} = 1.2\text{V}$, $I_Q = 3.3\mu\text{A}$, $I_{SD} < 1\mu\text{A}$, MSOP-16E
LT8612	42V, 6A, 96% Efficiency, 2.2MHz Synchronous MicroPower Step-Down DC/DC Converter with $I_Q = 2.5\mu\text{A}$	$V_{IN(MIN)} = 3.4\text{V}$, $V_{IN(MAX)} = 42\text{V}$, $V_{OUT(MIN)} = 0.97\text{V}$, $I_Q = 3.0\mu\text{A}$, $I_{SD} < 1\mu\text{A}$, 3mm x 6mm QFN-28
LT8613	42V, 6A, 96% Efficiency, 2.2MHz Synchronous MicroPower Step-Down DC/DC Converter with Current Limiting	$V_{IN(MIN)} = 3.4\text{V}$, $V_{IN(MAX)} = 42\text{V}$, $V_{OUT(MIN)} = 0.97\text{V}$, $I_Q = 3.0\mu\text{A}$, $I_{SD} < 1\mu\text{A}$, 3mm x 6mm QFN-28
LT8602	42V, Quad Output (2.5A + 1.5A + 1.5A + 1.5A) 95% Efficiency, 2.2MHz Synchronous MicroPower Step-Down DC/DC Converter with $I_Q = 25\mu\text{A}$	$V_{IN(MIN)} = 3\text{V}$, $V_{IN(MAX)} = 42\text{V}$, $V_{OUT(MIN)} = 0.8\text{V}$, $I_Q = 2.5\mu\text{A}$, $I_{SD} < 1\mu\text{A}$, 6mm x 6mm QFN-40

Looking for pricing, stock, or lifecycle information?

Click below to explore more details on WIN SOURCE:

 [View LT8640HUDCF#PBF on WIN SOURCE](#)

 [Analog Devices Inc. Information](#)

Optimize Your Supply Chain with WIN SOURCE Solutions

-  Global Sourcing Solution
-  Obsolete Management
-  Cost Control Management
-  Shortage Management
-  Alternative Solution
-  Excess Inventory Management