



**THE DATASHEET OF
LT6274IS5#TRMPBF**



FEATURES

- 2200V/ μ s Slew Rate
- 90MHz -3 dB Bandwidth ($A_V = +1$)
- 40MHz Gain-Bandwidth Product
- 1.6mA Supply Current per Amplifier
- C-Load™ Op Amp Drives All Capacitive Loads
- ± 4.5 V to ± 16 V Operating Supply Range
- Unity-Gain Stable
- 10nV/ $\sqrt{\text{Hz}}$ Input Noise Voltage
- 400 μ V Maximum Input Offset Voltage
- 500nA Maximum Input Bias Current
- 30nA Maximum Input Offset Current
- ± 13.25 V Minimum Output Swing into 1k (± 15 V Supply)
- ± 3.5 V Minimum Output Swing into 500 Ω (± 5 V Supply)
- 74dB Minimum Open-Loop Gain, $R_L = 1$ k
- 40ns Settling Time to 1%, 10V Step
- Specified at ± 5 V and ± 15 V
- Single in 5-Lead TSOT-23 Package
- Dual in 8-Lead MSOP Package

APPLICATIONS

- Wideband Large Signal Amplification
- Cable Drivers
- Buffers
- Automated Test Equipment
- Data Acquisition Systems
- High Fidelity Video and Audio Amplification

DESCRIPTION

The **LT[®]6274/LT6275** are single/dual low power, high speed, very high slew rate operational amplifiers with outstanding AC and DC performance. The circuit topology is a voltage feedback amplifier with matched high impedance inputs plus the enhanced slewing performance of a current feedback amplifier. The high slew rate and single stage design provide excellent settling characteristics that make the circuit an ideal choice for data acquisition systems. Each output drives a 1k load to ± 13.25 V with ± 15 V supplies and a 500 Ω load to ± 3.5 V on ± 5 V supplies. The LT6274/LT6275 are stable with any capacitive load making them useful in buffer or cable driving applications.

The LT6274 single op amp is available in a 5-lead TSOT-23 package, and the LT6275 dual op amp is available in an 8-lead MSOP package. They operate with guaranteed specifications over the -40°C to 85°C and -40°C to 125°C temperature ranges.

All registered trademarks and trademarks are the property of their respective owners. All other trademarks are the property of their respective owners.

TYPICAL APPLICATION

Wideband Large Signal Amplification

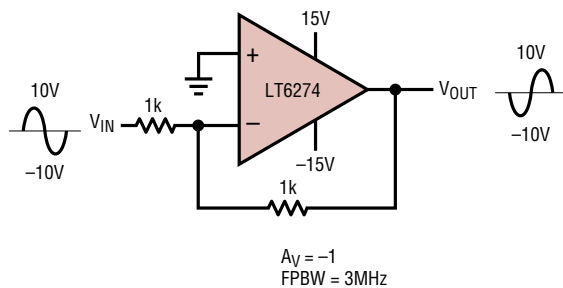

6275 TA01

Undistorted Output Swing vs Frequency

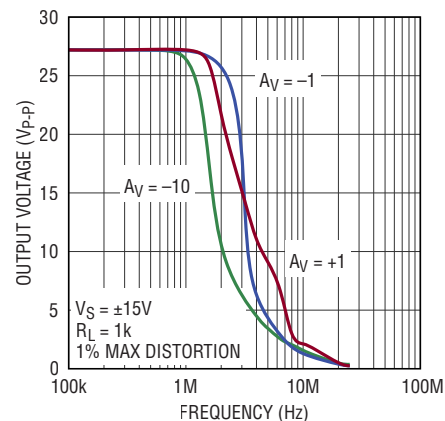

6275 G31

6275fa

LT6274/LT6275

ABSOLUTE MAXIMUM RATINGS

(Note 1)

Total Supply Voltage ($V^+ - V^-$)	34V
Differential Input Voltage (Transient Only) (Note 2)	$\pm 10V$
Input Voltage.....	V^- to V^+
Input Current (+IN, -IN) (Note 3)	$\pm 10mA$
Output Current (Note 12)	115mA _{RMS}
Output Short-Circuit Current Duration (Note 4)	Thermally Limited

Operating Temperature Range (Note 5)	
LT6274I/LT6275I	-40°C to 85°C
LT6274H/LT6275H	-40°C to 125°C
Specified Temperature Range (Note 6)	
LT6274I/LT6275I	-40°C to 85°C
LT6274H/LT6275H	-40°C to 125°C
Maximum Junction Temperature	150°C
Storage Temperature Range	-65°C to 150°C
Lead Temperature (Soldering, 10 sec).....	300°C

PIN CONFIGURATION

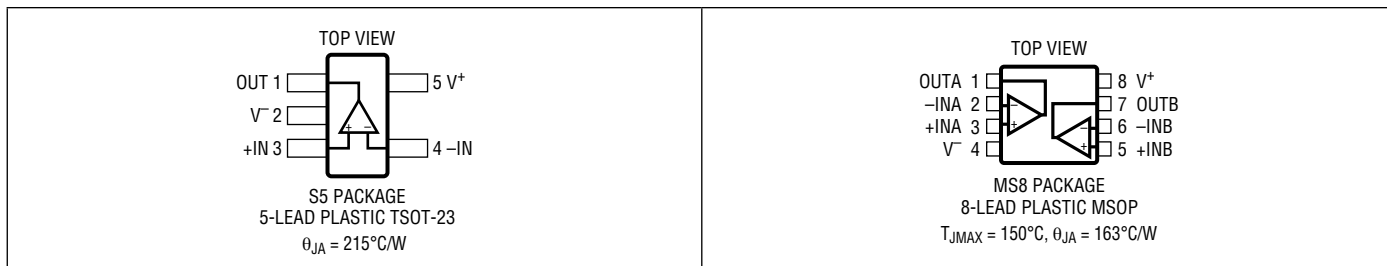

ORDER INFORMATION <http://www.linear.com/product/LT6275#orderinfo>

TUBE	TAPE AND REEL	PART MARKING*	PACKAGE DESCRIPTION	SPECIFIED TEMPERATURE RANGE
LT6274IS5#PBF	LT6274IS5 #TRPBF	LTHCY	5-Lead Plastic TSOT-23	-40°C to 85°C
LT6274HS5#PBF	LT6274HS5 #TRPBF	LTHCY	5-Lead Plastic TSOT-23	-40°C to 125°C
LT6275IMS8#PBF	LT6275IMS8 #TRPBF	LTFYV	8-Lead Plastic MSOP	-40°C to 85°C
LT6275HMS8#PBF	LT6275HMS8 #TRPBF	LTFYV	8-Lead Plastic MSOP	-40°C to 125°C

*The temperature grade is identified by a label on the shipping container.

Consult LTC Marketing for parts specified with wider operating temperature ranges. Parts ending with PBF are RoHS and WEEE compliant.

For more information on lead free part marking, go to: <http://www.linear.com/leadfree/>

For more information on tape and reel specifications, go to: <http://www.linear.com/tapeandreeel/>. Some packages are available in 500 unit reels through designated sales channels with #TRMPBF suffix.

ELECTRICAL CHARACTERISTICS The ● denotes the specifications which apply over the full operating temperature range, otherwise specifications are at $T_A = 25^\circ\text{C}$. Unless noted otherwise, $V_{CM} = 0\text{V}$, and specifications apply at both $V_S = (V^+ - V^-) = \pm 5\text{V}$ and $\pm 15\text{V}$.

SYMBOL	PARAMETER	CONDITIONS	MIN	TYP	MAX	UNITS
V_{OS}	Input Offset Voltage (Note 7)		●	± 0.15	± 0.4	mV
					± 1.2	mV
$\Delta V_{OS}/\Delta T$	Input Offset Voltage Drift (Note 8)		●	± 4	± 10	$\mu\text{V}/^\circ\text{C}$
I_B	Input Bias Current		●	± 100	± 500	nA
					± 1000	nA
I_{OS}	Input Offset Current		●	± 3	± 30	nA
e_n	Input Voltage Noise Density	$f = 1\text{kHz}$		10		$\text{nV}/\sqrt{\text{Hz}}$
	Low Frequency Integrated Voltage Noise	0.1Hz to 10Hz		1		μV_{P-P}
1/f	1/f Noise Corner Frequency	Voltage Noise Current Noise		30		Hz
				70		Hz
i_n	Input Current Noise Density	$f = 1\text{kHz}$		0.5		$\text{pA}/\sqrt{\text{Hz}}$
R_{IN}	Input Resistance	Common Mode, $V_{CM} = \pm 12\text{V}$, $V_S = \pm 15\text{V}$	●	100	700	$\text{M}\Omega$
		Differential Mode			20	$\text{M}\Omega$
C_{IN}	Input Capacitance	Common Mode		3		pF
		Differential Mode		0.4		pF
V_{INCM}	Input Voltage Range + (Note 9)	$V_S = \pm 15\text{V}$ $V_S = \pm 5\text{V}$	● ●	12 2.5	13.4 3.4	V V
	Input Voltage Range - (Note 9)	$V_S = \pm 15\text{V}$ $V_S = \pm 5\text{V}$	● ●	-13.2 -3.2	-12 -2.5	V V
CMRR	Common Mode Rejection Ratio	$V_S = \pm 15\text{V}$, $V_{CM} = \pm 12\text{V}$	●	90	110	dB
		$V_S = \pm 5\text{V}$, $V_{CM} = \pm 2.5\text{V}$	●	80	102	dB
PSRR	Power Supply Rejection Ratio	$V_S = \pm 4.5\text{V}$ to $\pm 16\text{V}$	●	90	115	dB
V_S	Supply Voltage Range (Note 10)		●	9	32	V
	Channel Separation	$V_S = \pm 15\text{V}$, $V_{OUT} = \pm 1\text{V}$, $A_V = 1$, $R_L = 1\text{k}\Omega$	●	100	126	dB
A_{VOL}	Open-Loop Voltage Gain	$V_S = \pm 15\text{V}$, $V_{OUT} = \pm 12\text{V}$, $R_L = 1\text{k}\Omega$	●	74	90	dB
		$V_S = \pm 5\text{V}$, $V_{OUT} = \pm 2.5\text{V}$, $R_L = 500\Omega$	●	68	84	dB
V_{OUT}	Maximum Output Voltage Swing	$\pm 40\text{mV}$ Input Overdrive $V_S = \pm 15\text{V}$, $R_L = 1\text{k}\Omega$	●	± 13.25	± 13.5	V
		$V_S = \pm 5\text{V}$, $R_L = 500\Omega$	●	± 3.5	± 3.8	V
I_{OUT}	Output Current	$V_S = \pm 15\text{V}$, $V_{OUT} = \pm 12\text{V}$, $V_{IN} = \pm 40\text{mV}$	●	± 15	± 35	mA
		$V_S = \pm 5\text{V}$, $V_{OUT} = \pm 2.5\text{V}$, $V_{IN} = \pm 40\text{mV}$	●	± 12	± 30	mA
I_{SC}	Output Short-Circuit Current	$V_S = \pm 15\text{V}$, $V_{OUT} = 0\text{V}$, $V_{IN} = \pm 3\text{V}$	●	± 35	± 90	mA
		$V_S = \pm 5\text{V}$, $V_{OUT} = 0\text{V}$, $V_{IN} = \pm 3\text{V}$	●	± 30	± 80	mA
I_S	Supply Current	Per Amplifier, $V_S = \pm 15\text{V}$	●	1.6	1.7	mA
					2.3	mA
SR	Slew Rate (Note 11)	$V_S = \pm 15\text{V}$, $A_V = 1$		2200		$\text{V}/\mu\text{s}$
		$V_S = \pm 15\text{V}$, $A_V = -1$		1600		$\text{V}/\mu\text{s}$
		$V_S = \pm 15\text{V}$, $A_V = -2$	●	900	1250	$\text{V}/\mu\text{s}$
		$V_S = \pm 5\text{V}$, $A_V = -2$	●	270	400	$\text{V}/\mu\text{s}$
FPBW	Full Power Bandwidth	$V_S = \pm 15\text{V}$, 10V Peak, $A_V = -1$, <1% THD		3		MHz
		$V_S = \pm 5\text{V}$, 1V Peak, $A_V = -1$, <1% THD		8		MHz
GBW	Gain-Bandwidth Product	$f_{TEST} = 200\text{kHz}$ $V_S = \pm 15\text{V}$	●	28	40	MHz
		$V_S = \pm 5\text{V}$	●	25	36	MHz
f_{-3dB}	Unity Gain -3dB Bandwidth	$V_{OUT} = 100\text{mV}_{P-P}$, $V_S = \pm 15\text{V}$		90		MHz

ELECTRICAL CHARACTERISTICS

The ● denotes the specifications which apply over the full operating temperature range, otherwise specifications are at $T_A = 25^\circ\text{C}$. Unless noted otherwise, $V_{CM} = 0\text{V}$, and specifications apply at both $V_S = (V^+ - V^-) = \pm 5\text{V}$ and $\pm 15\text{V}$.

SYMBOL	PARAMETER	CONDITIONS	MIN	TYP	MAX	UNITS
t_R, t_F	Small Signal Rise/Fall Time	$A_V = 1, 10\% - 90\%, 100\text{mV}$ Input Step		4		ns
t_{PD}	Propagation Delay	50% V_{IN} to 50% V_{OUT} , 100mV Input Step		4		ns
t_s	Settling Time	1% of 10V Step, $A_V = 1, V_S = \pm 15\text{V}$		40		ns
		0.1% of 10V Step, $A_V = 1, V_S = \pm 15\text{V}$		185		ns
		1% of 5V Step, $A_V = 1, V_S = \pm 5\text{V}$		65		ns

Note 1: Stresses beyond those listed under Absolute Maximum Ratings may cause permanent damage to the device. Exposure to any Absolute Maximum Rating condition for extended periods may affect device reliability and lifetime.

Note 2: Differential inputs of $\pm 10\text{V}$ are appropriate for transient operation only, such as during slewing. Large, sustained differential inputs will cause excessive power dissipation and may damage the part. See Input Considerations in the Applications Information section of this data sheet for more details.

Note 3: The inputs are protected by ESD protection diodes to each power supply. The Input current should be limited to less than 10mA.

Note 4: A heat sink may be required to keep the junction temperature below the absolute maximum rating when the output is shorted indefinitely.

Note 5: The LT6274/LT6275I are guaranteed functional over the operating temperature range of -40°C to 85°C . The LT6274H/LT6275H are guaranteed functional over the operating temperature range of -40°C to 125°C .

Note 6: The LT6274I/LT6275I are guaranteed to meet specified performance from -40°C to 85°C . The LT6274H/LT6275H are guaranteed to meet specified performance from -40°C to 125°C .

Note 7: Input offset voltage is pulse tested and is exclusive of warm-up drift.

Note 8: This parameter is not 100% tested.

Note 9: Input voltage range is guaranteed by common mode rejection ratio test.

Note 10: Supply voltage range is guaranteed by power supply rejection ratio test.

Note 11: Slew rate is measured between 20% and 80% of output step with $\pm 6\text{V}$ input (at $A_V = -2$) and $\pm 10\text{V}$ input (at $A_V = \pm 1$) for $\pm 15\text{V}$ supplies, and between 35% and 65% of output step with $\pm 1.75\text{V}$ input (at $A_V = -2$) for $\pm 5\text{V}$ supplies.

Note 12: Current density limitations within the IC require the continuous RMS current supplied by the output (sourcing or sinking) over the operating lifetime of the part be limited to under 115mA (Absolute Maximum). Proper heat sinking may be required to keep the junction temperature below the absolute maximum rating.

TYPICAL PERFORMANCE CHARACTERISTICS

Supply Current vs Supply Voltage and Temperature (per Amplifier)

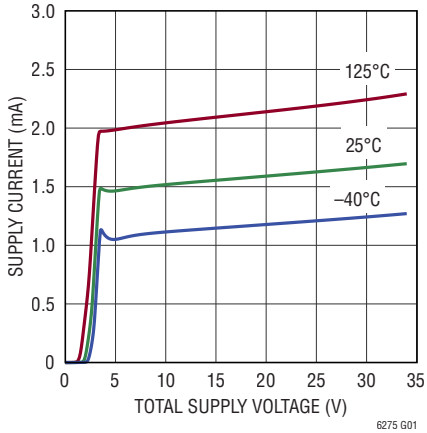

Input Offset Voltage vs Input Common Mode Voltage

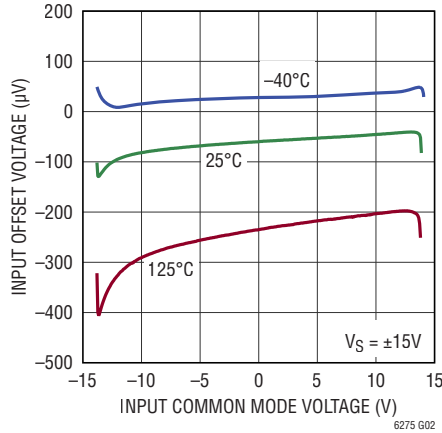

Typical Distribution of Input Offset Voltage Drift

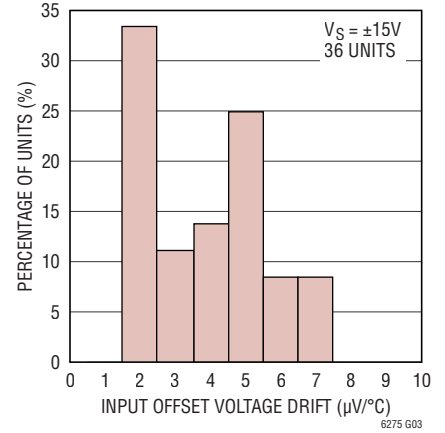

Input Bias Current vs Input Common Mode Voltage

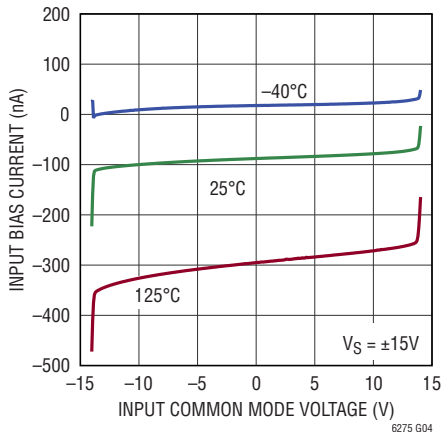

Input Bias Current vs Temperature

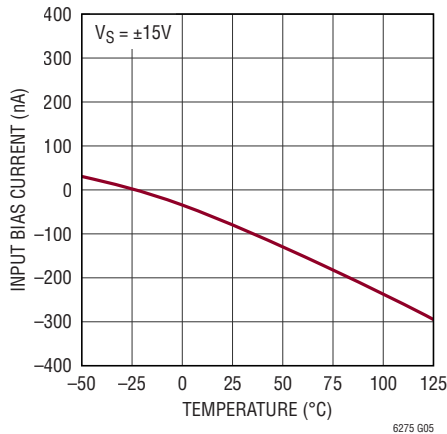

Open-Loop Gain vs Temperature

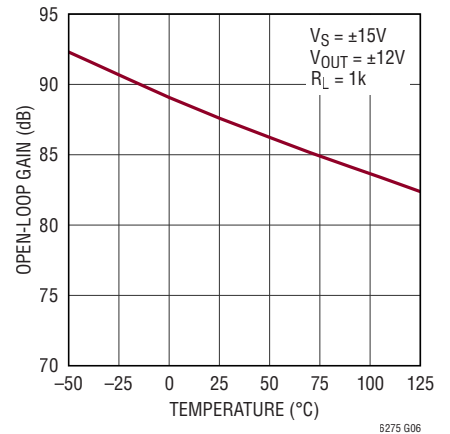

Open-Loop Gain vs Temperature

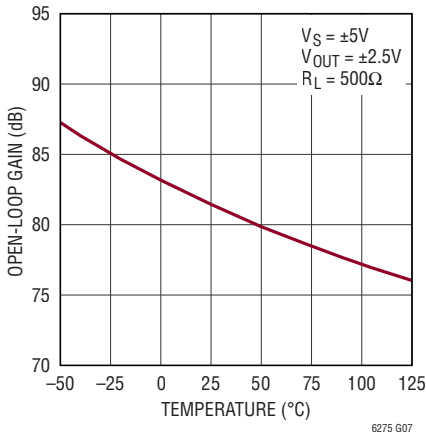

Open-Loop Gain vs Resistive Load

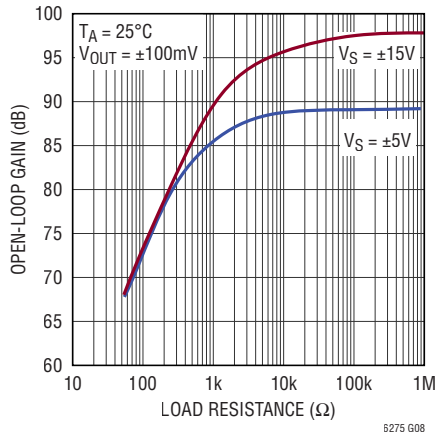

Output Voltage Swing vs Resistive Load

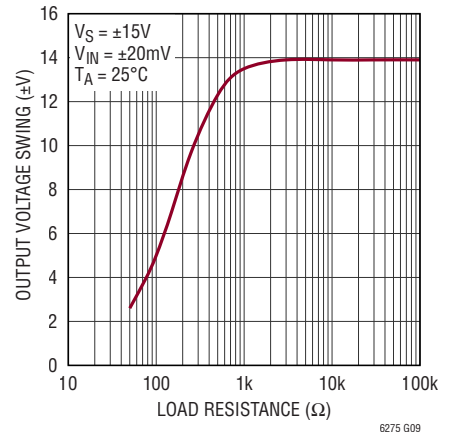

TYPICAL PERFORMANCE CHARACTERISTICS

Output Voltage Swing vs Resistive Load

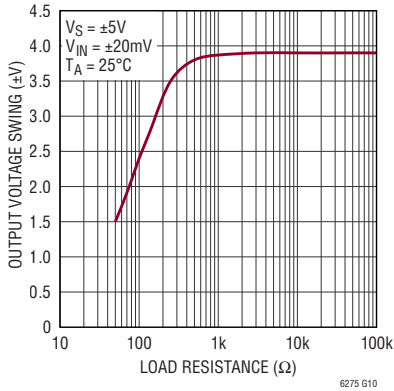

Output Voltage Swing vs Supply Voltage

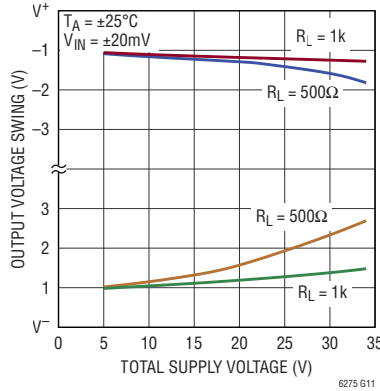

Output Voltage Swing vs Load Current

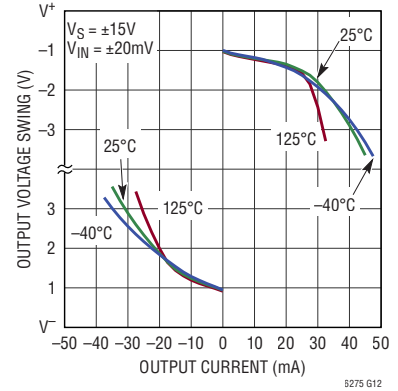

Output Voltage Swing vs Load Current

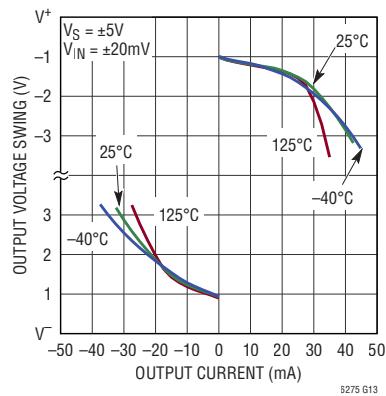

Output Short-Circuit Current vs Temperature

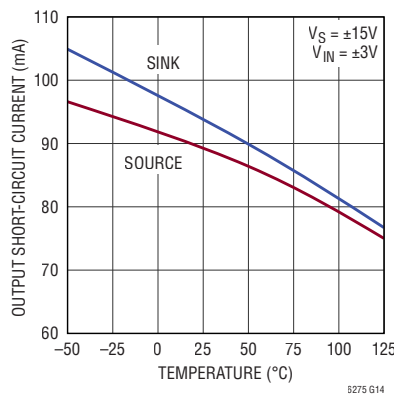

Output Short-Circuit Current vs Temperature

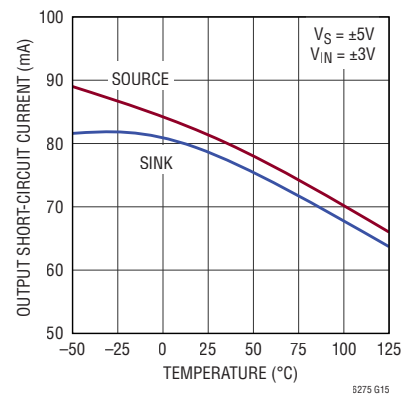

Input Noise Spectral Density

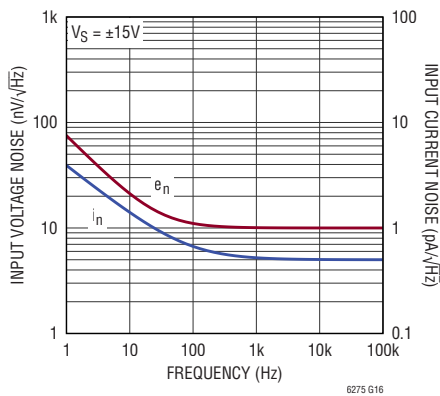

0.1Hz to 10Hz Input Voltage Noise

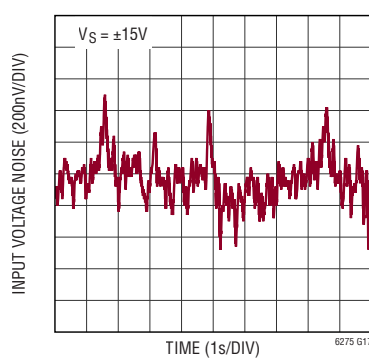

Settling Time vs Output Step

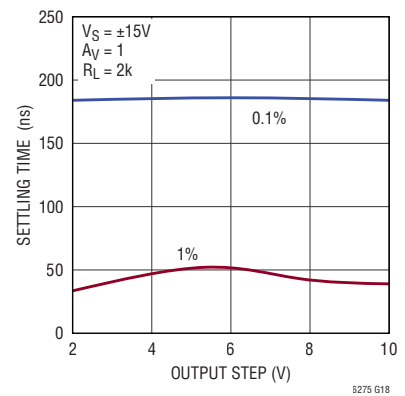

TYPICAL PERFORMANCE CHARACTERISTICS

Closed-Loop Output Impedance vs Frequency

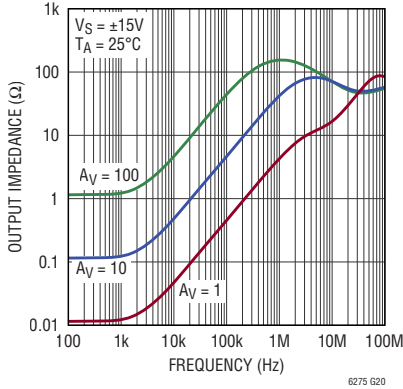

Gain/Phase vs Frequency

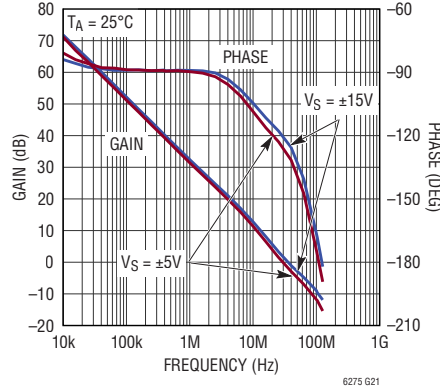

Gain-Bandwidth Product and Phase Margin vs Temperature

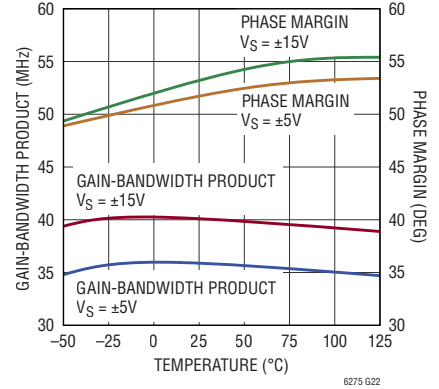

Gain-Bandwidth Product and Phase Margin vs Supply Voltage

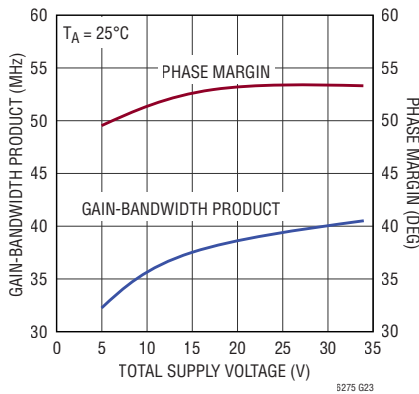

Closed-Loop Frequency Response vs Load Capacitance

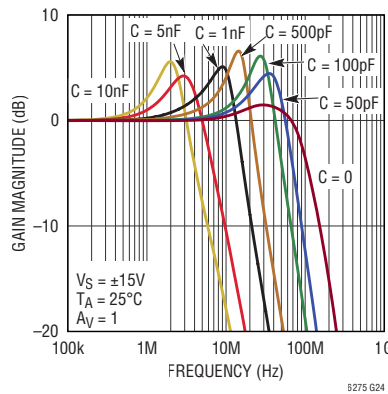

Closed-Loop Frequency Response vs Load Capacitance

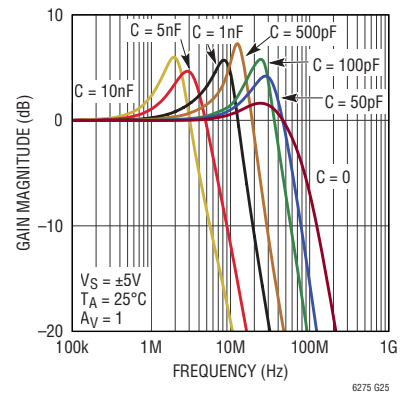

Crosstalk vs Frequency

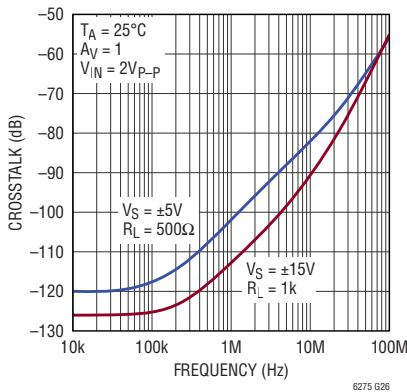

Power Supply Rejection Ratio vs Frequency

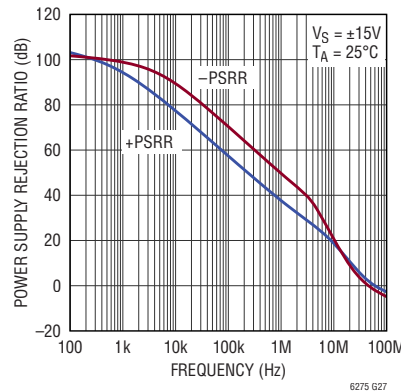

Common Mode Rejection Ratio vs Frequency

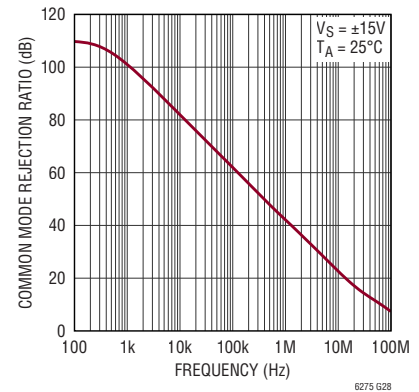

TYPICAL PERFORMANCE CHARACTERISTICS

2nd and 3rd Harmonic Distortion vs Frequency ($A_V = 1$)

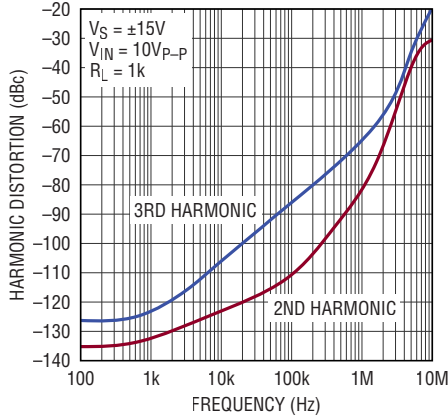

2nd and 3rd Harmonic Distortion vs Frequency ($A_V = -1$)

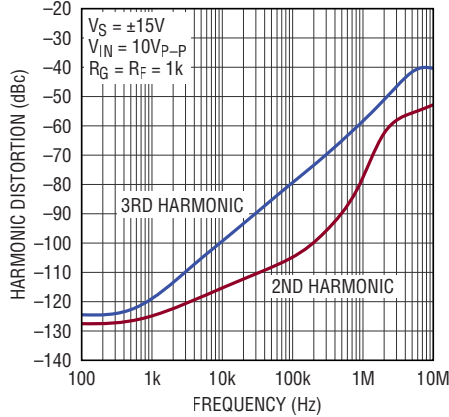

Undistorted Output Swing vs Frequency

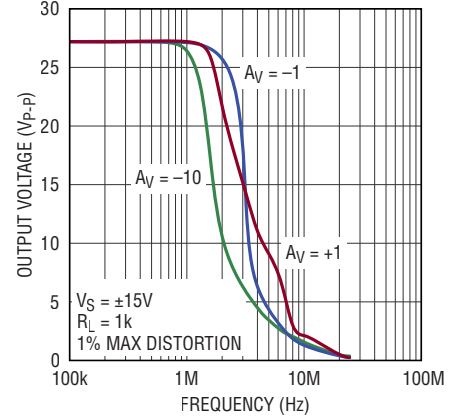

Undistorted Output Swing vs Frequency

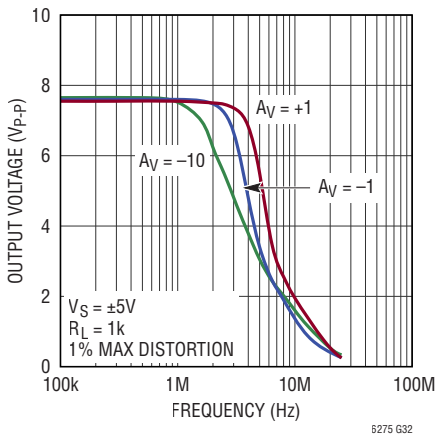

Slew Rate vs Input Level

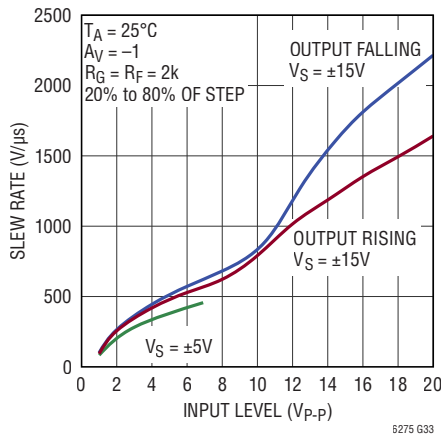

Slew Rate vs Temperature

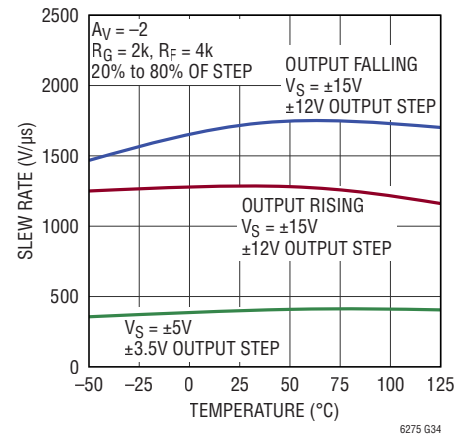

Slew Rate vs Capacitive Load

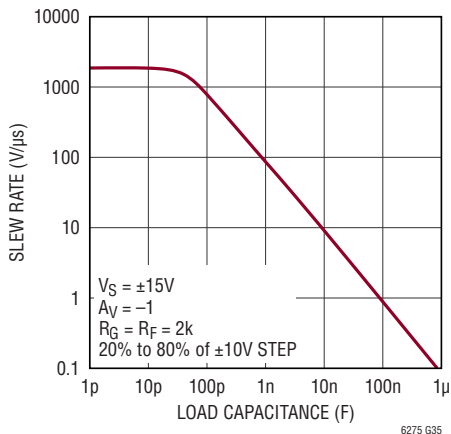

Step Response Overshoot vs Capacitive Load

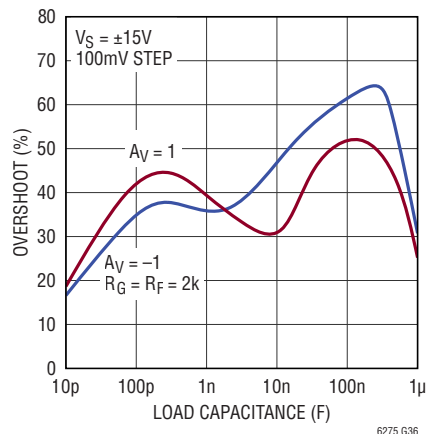

TYPICAL PERFORMANCE CHARACTERISTICS

Small-Signal Step Response
($A_V = 1$)

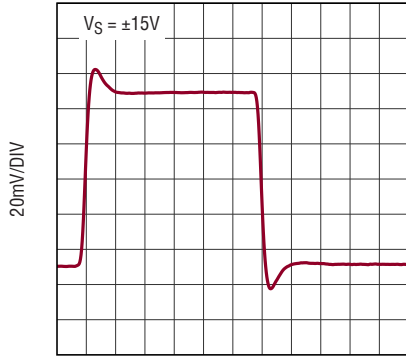

20ns/DIV

6275 G37

Small-Signal Step Response
($A_V = -1$)

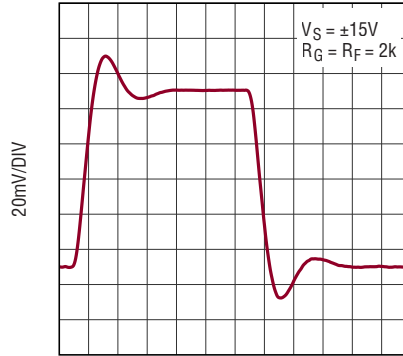

20ns/DIV

6275 G38

Small-Signal Step Response
($A_V = 1, C_L = 10nF$)

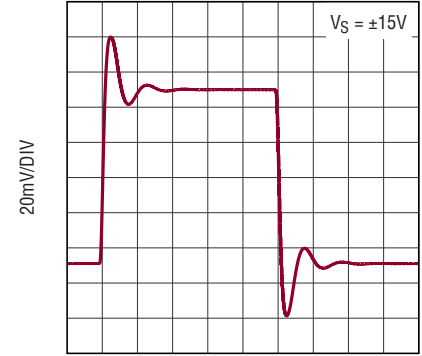

500ns/DIV

6275 G39

Large-Signal Step Response
($A_V = 1$)

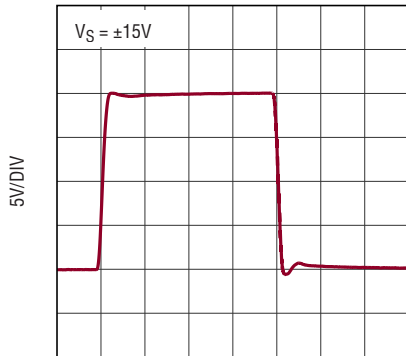

50ns/DIV

6275 G40

Large-Signal Step Response
($A_V = -1$)

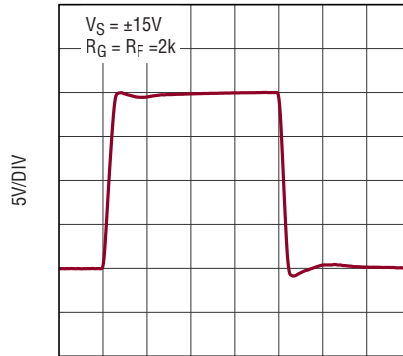

50ns/DIV

6275 G41

Large-Signal Step Response
($A_V = 1, C_L = 10nF$)

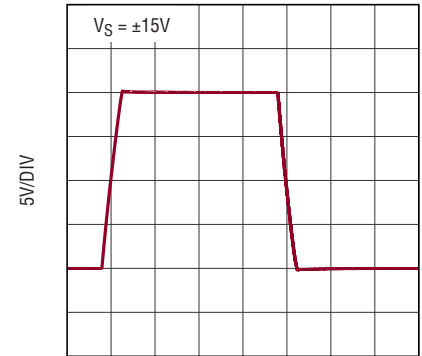

5µs/DIV

6275 G42

SIMPLIFIED SCHEMATIC (ONE AMPLIFIER SHOWN)

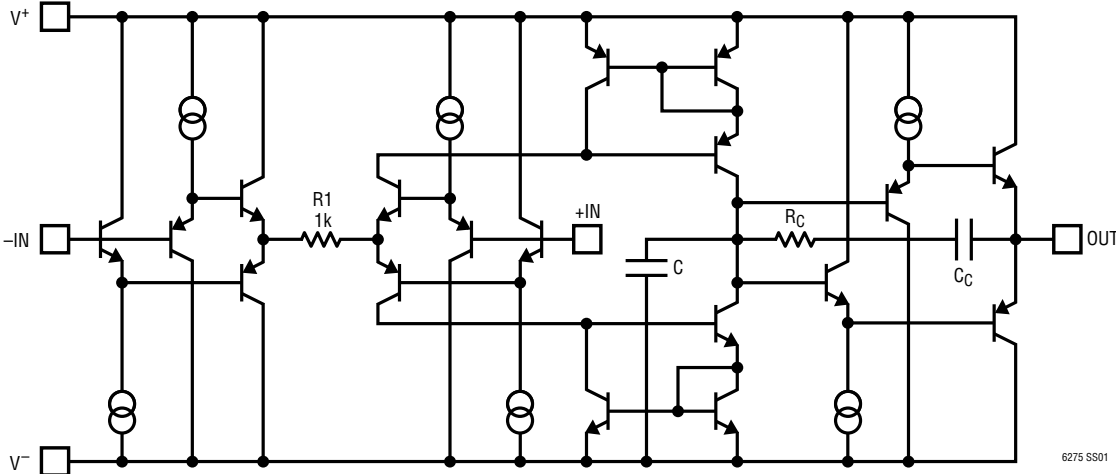

6275 SS01

PIN FUNCTIONS

-IN: Inverting Input of Amplifier.

+IN: Noninverting Input of Amplifier.

V⁺: Positive Supply Voltage. Total supply voltage ($V^+ - V^-$) ranges from 9V to 32V.

V⁻: Negative Supply Voltage. Total supply voltage ($V^+ - V^-$) ranges from 9V to 32V.

OUT: Amplifier Output.

APPLICATIONS INFORMATION

Circuit Operation

The LT6274/LT6275 circuit topology is a true voltage feedback amplifier that has the slewing behavior of a current feedback amplifier. The operation of the circuit can be understood by referring to the simplified schematic. The inputs are buffered by complementary NPN and PNP emitter followers that drive a 1k resistor. The input voltage appears across the resistor generating currents that are mirrored into the high impedance node. Complementary followers form an output stage that buffers the gain node from the load. The bandwidth is set by the internal input resistor and the capacitance on the high impedance node. The slew rate is determined by the current available to charge the gain node capacitance. This current is the differential input voltage divided by R1, so the slew rate is proportional to the input. This important characteristic gives the LT6274/LT6275 superior slew performance compared to conventional voltage feedback amplifiers in which the slew rate is constrained by a fixed current (biasing the input transistors) available to charge the gain node capacitance (independent of the magnitude of the differential input voltage). Therefore, in the LT6274/LT6275, highest slew rates are seen in the lowest gain configurations. For example, a 10V output step in a gain of 10 has only a 1V input step, whereas the same output step in unity gain has a 10 times greater input step. The curve of Slew Rate vs Input Level illustrates this relationship. The LT6274/LT6275 are tested in production for slew rate in a gain of -2 so higher slew rates can be expected in gains of 1 and -1, with lower slew rates in higher gain configurations.

Special compensation across the output buffer allows the LT6274/LT6275 to be stable with any capacitive load. The RC network across the output stage is bootstrapped when the amplifier is driving a light or moderate load and has no effect under normal operation. When driving a capacitive load (or a low value resistive load) the network is incompletely bootstrapped and adds to the compensation at the high impedance node. The added capacitance slows down the amplifier by lowering the dominant pole frequency, improving the phase margin. The zero created by the RC combination adds phase to ensure that even for very large load capacitances, the total phase lag does not exceed 180° (zero phase margin), and the amplifier remains stable.

Comparison to Current Feedback Amplifiers

The LT6274/LT6275 enjoy the high slew rates of Current Feedback Amplifiers (CFAs) while maintaining the characteristics of a true voltage feedback amplifier. The primary differences are that the LT6274/LT6275 have two high impedance inputs, and the closed loop bandwidth decreases as the gain increases. CFAs have a low impedance inverting input and maintain relatively constant bandwidth with increasing gain. The LT6274/LT6275 can be used in all traditional op amp configurations including integrators and applications such as photodiode amplifiers and I-to-V converters where there may be significant capacitance on the inverting input. The frequency compensation is internal and does not depend on the value of the external feedback resistor. For CFAs, by contrast, the feedback resistance is fixed for a given bandwidth, and capacitance on the inverting input can cause peaking or oscillations. The slew rate of the LT6274/LT6275 in noninverting gain configurations is also superior to that of CFAs in most cases.

Input Considerations

Each of the LT6274/LT6275 inputs is the base of an NPN and a PNP transistor whose base currents are of opposite polarity and provide first-order input bias current cancellation. Because of differences between NPN and PNP beta, the polarity of the input bias current can be positive or negative. The offset current does not depend on NPN/PNP beta matching and is well controlled. The use of balanced source resistance at each input is therefore recommended for applications where DC accuracy must be maximized.

The inputs can withstand transient differential input voltages up to $\pm 10\text{V}$ without damage and need no clamping or source resistance for protection. Differential inputs, however, generate large supply currents (tens of mA) as required for high slew rates. If the device is used with sustained differential inputs, the average supply current will increase, excessive power dissipation will result, and the part may be damaged. **The part should not be used as a comparator, peak detector or in other open-loop applications with large, sustained differential inputs.** Under normal, closed-loop operation, an increase of power dissipation is only noticeable in applications with

APPLICATIONS INFORMATION

large slewing outputs, and the increased power is proportional to the magnitude of the differential input voltage and the percent of the time that the inputs are apart. Measure the average supply current for the application in order to calculate the power dissipation.

Capacitive Loading

The LT6274/LT6275 are stable with any capacitive load. As previously stated in the Circuit Operation section of this data sheet, this is accomplished by dynamically sensing the load-induced output pole and adjusting the compensation at the amplifier's internal gain node. As the capacitive load increases, the bandwidth will decrease. The phase margin may increase or decrease with different capacitive loads, and so there may be peaking in the frequency domain and overshoot in the transient response for some capacitive loads as shown in the Typical Performance curves. The Small-Signal Step Response curve with 10nF load shows 30% overshoot. For large load capacitance, the slew rate of the LT6274/LT6275 can be limited by the output current available to charge the load capacitor according to:

$$SR = \frac{I_{SC}}{C_L}$$

The Large-Signal Step Response with 10nF load shows the output slew rate being limited to 9V/μs by the output short-circuit current. Coaxial cable can be driven directly, but for best pulse fidelity the cable should be properly terminated by placing a resistor of value equal to the characteristic impedance of the cable (e.g. 50Ω) in series with the output. The other end of the cable should be terminated with the same value resistor to ground.

Layout and Passive Components

The LT6274/LT6275 are easy to use and tolerant of less than ideal layouts. For maximum performance use a ground plane, short lead lengths, and RF-quality ceramic bypass capacitors (0.01μF to 0.1μF). For high drive current applications use low ESR bypass capacitors (1μF to 10μF ceramic or tantalum). The resistance of the parallel

combination of the feedback resistor and gain setting resistor on the inverting input combines with the total capacitance on that node, C_{IN} , to form a pole which can cause peaking or oscillations. If feedback resistors greater than 5k are used, a parallel capacitor of value

$$C_F > R_G \times C_{IN}/R_F$$

should be used to cancel the input pole and optimize dynamic performance. For unity-gain applications where a large feedback resistor is used, C_F should be greater than or equal to C_{IN} .

Power Dissipation

The LT6274/LT6275 combine high speed and large output drive in a small package. Because of the wide supply voltage range, it is possible to exceed the maximum junction temperature under certain conditions. Maximum junction temperature (T_J) is calculated from the ambient temperature (T_A), the device's power dissipation (P_D), and the thermal resistance of the device (θ_{JA}) as follows:

$$T_J = T_A + (P_D \times \theta_{JA})$$

Worst case power dissipation occurs at the maximum supply current and when the output voltage is at 1/2 of either V^+ or V^- (on split rails), or at the maximum output swing (if less than 1/2 of the rail voltage). Therefore P_{DMAX} (per amplifier) is:

$$P_{DMAX} = (V^+ - V^-)(I_{SMAX}) + (V^+/2)^2/R_L$$

Example: For an LT6274 with thermal resistance of 215°C/W, operating on ±15V supplies and driving a 1kΩ load to 7.5V, the maximum power dissipation is calculated to be:

$$P_{DMAX} = (30V)(2.3mA) + (7.5V)^2/1k\Omega = 125mW$$

This leads to a die temperature rise above ambient of:

$$T_{RISE} = (125mW)(215°C/W) = 27°C$$

This implies that the maximum ambient temperature at which the LT6274 should operate under the above conditions is:

$$T_A = 150°C - 27°C = 123°C$$

TYPICAL APPLICATIONS

Noninverting Amplifier Slew Rate and Step Response

Figure 1 shows a noninverting amplifier with closed-loop gain of 11V/V. The closed-loop bandwidth of this amplifier is approximately GBW/11 (GBW = Gain-Bandwidth Product). For a step input, the output follows an exponential curve:

$$V_{OUT} = V_{INITIAL} + A_V \cdot V_{INPUTSTEP} \cdot \left(1 - e^{-\left(\frac{t}{\tau}\right)} \right) \quad (1)$$

where τ = time constant associated with the closed-loop bandwidth.

The maximum slew rate occurs in the beginning of the output response:

$$V_{OUTSRMAX} = A_V \cdot V_{INPUTSTEP} \cdot \frac{1}{\tau} \quad (2)$$

Keep in mind that the closed-loop bandwidth and the closed-loop gain are related ($\tau = \tau_0 A_V$), so Equation (2) is simplified to:

$$V_{OUTSRMAX} = V_{INPUTSTEP} \cdot \frac{1}{\tau_0} \quad (3)$$

where τ_0 = time constant associated with the LT6274/LT6275 GBW.

Interestingly, Equation (3) reveals that the maximum slew rate is nominally related only to the input step size and the op amp's inherent GBW. Closing the loop to implement $A_V > 1$ gain configurations slows down the response, but increases the excursion. The resulting maximum slew rate remains the same.

The LT6274/LT6275 feature ample slew rate capability with low power consumption. Because the input stage architecture allows high slew rate with low input stage quiescent currents, the overall power consumption when amplifying pulses is very low; additional power is only drawn from the supplies during the highest slew rate moments of the exponential response.

Since GBW of the LT6274/LT6275 is 40MHz, Equation (3) suggests that the maximum slew rate in a step response whose output swings 25V (implying $V_{INPUTSTEP} = 25/11 = 2.27V$) is 571V/ μ s. The LT6274/LT6275 high slew

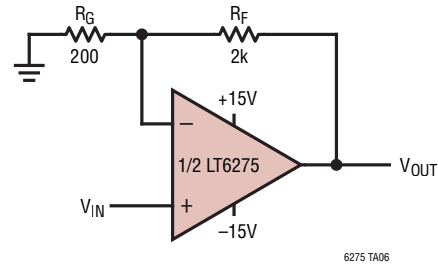

Figure 1. LT6275 Configured in a Noninverting Gain of $A_V = +11V/V$

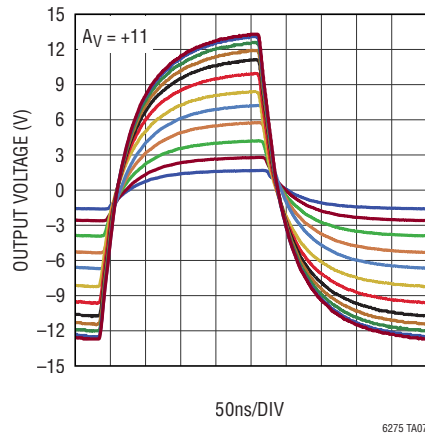

Figure 2. Noninverting Amplifier Step Response ($A_V = +11V/V$)

capability ensures that the output response is never slew rate limited despite the very high excursion.

Figure 2 shows the output response to varying input step amplitudes. Note that none of the exponential responses is limited by the initial slew rate (which increases with increasing amplitude).

As a particular example, with $A_V = +11V/V$, 15V output excursion, and 40 MHz GBW, Equation (3) predicts a maximum slew rate of 343V/ μ s. Measurement on the corresponding curve in Figure 2 shows 390V/ μ s, which is in good agreement with the prediction. As another example, with an 18.5V output excursion, the predicted maximum slew rate is 423V/ μ s; measurement shows 460V/ μ s.

As the peak to peak voltage of the input step changes, the maximum initial slew rate changes. The 63% rise time of the closed loop response, however, does not change (as seen in Figure 2), because the closed loop bandwidth stays constant for all input amplitudes.

TYPICAL APPLICATIONS

Using the LT6274/LT6275 to Create a Composite Amplifier with High Gain, High Bandwidth and Large Output Signal Capability

While the LT6274/LT6275 provide ample slew rate and large output swing capability, the GBW is not so large as to achieve high gain, high bandwidth, and high amplitude at the same time. The circuit of Figure 3 harnesses the high slew rate capability of the LT6275 by placing it under control of the LTC6252, an op amp with greater than 700MHz GBW. The LTC6252 offers high bandwidth at low supply current, but with limited slew rate and limited output swing (since it is a 5V op amp). By creating a composite amplifier adding the LT6275 as a high-voltage, high-slew secondary op amp, this composite amplifier enables large output swing at high frequencies with relatively low power dissipation.

Circuit Description

R4 and R1 realize inverting gain of $-11V/V$ from V_{IN} to V_{OUT} . The LT6275 op amp drives the output based on whatever is commanded by the middle node, V_{MID} . The LTC6252 is very fast relative to the LT6275. As a consequence, the LTC6252 controlling first stage can force the LT6275 output to move quickly by providing sufficient differential input voltage to the LT6275. With the inverting input of the LT6275 tied to a DC bias voltage, the LTC6252 needs merely to drive the noninverting input.

Unlike the LTC6252, the LT6275 slew rate increases linearly with its differential input voltage. Hence, the LTC6252 benefits from using the LT6275 as a slew enhancer.

Optimizing the Loop

Larger R2 increases the local gain taken by the LTC6252. Since the total gain is fixed by the global feedback around the composite amplifier ($A_V = -R4/R1 = -11V/V$), raising the gain in the LTC6252 lowers the gain requirement of the LT6275, increasing the overall bandwidth of the composite amplifier. Care must be taken to not take too much gain in the LTC6252, as the reduction in the LTC6252 bandwidth and the resulting additional phase shift seen at the output of the LTC6252 can lower the stability margins of the composite amplifier. Conversely, smaller R2

reduces the LTC6252 phase shift, but it also adds to the gain burden of the LT6275.

R2 was selected to take a gain of 2V/V in the LTC6252, implying a gain of 5.5V/V being taken in the LT6275. The 5.5V/V gain is required to translate the 5V maximum output swing of the LTC6252 to the 27.5V maximum output swing of the LT6275 (when operated at $\pm 15V$ supplies). It may be possible to achieve even higher bandwidth in the composite amplifier if a high speed $\pm 5V$ (rather than 5V, 0V) op amp replaces the LTC6252 as the first stage, with the resulting increased first-stage output swing lowering the gain that has to be taken in the LT6275.

Capacitor C7 in Figure 3 is adjusted to create a favorable looking transient response. Figure 4 shows the transient response at the output of the LT6275 as C7 varies. C7 = 3pF was chosen.

DC Biasing

In the circuit of Figure 3, LTC6252 supplies were chosen to be 5V and 0V, which are more practical than split $\pm 2.5V$ supplies. R5 and R6 form a resistive divider to bias the noninverting input of LTC6252 and the inverting input of LT6275 at the middle of this rail, 2.5V. Note that this approach results in the output of LT6275 having a DC offset of 2.5V, which reduces the potential peak to peak output excursion of the composite amplifier since LT6275 is powered up from split $\pm 15V$ supplies.

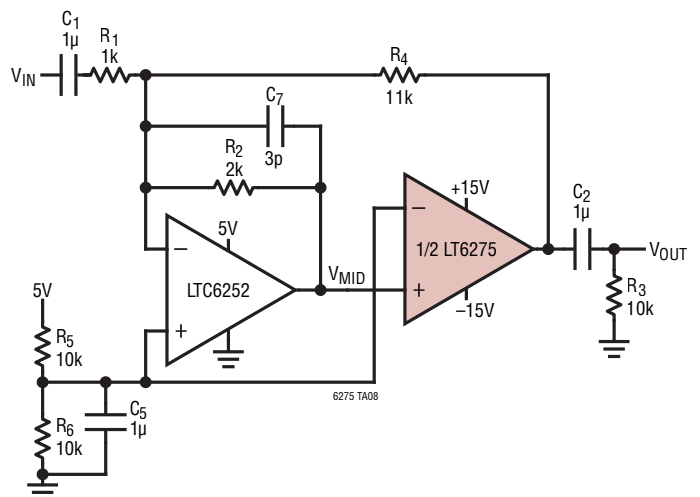

Figure 3. Composite Amplifier Using LTC6252 and LT6275 ($A_V = -11V/V$)

TYPICAL APPLICATIONS

Pulse Response

Figure 5 shows the output step response of the composite amplifier (measured at the output of the LT6275) at many different amplitudes. At 15V output excursion, the initial slope is measured to be 725V/ μ s. This slope is faster than the 390V/ μ s measured with a 15V output excursion using the simple noninverting amplifier of Figure 1. According to Equation (3), this improvement has been made possible because the effective bandwidth of the composite amplifier is higher (and thus has a lower τ_o), as intended.

Sine Waves

The composite amplifier of Figure 3 was also tested with sine waves. Figure 6 shows the small signal closed-loop gain and phase response. Distortion was also evaluated for this circuit: for a 20V_{p-p} output signal at 1MHz, HD2/HD3 were measured to be -55dBc/-47dBc, respectively. These numbers are more impressive when considering the very low power dissipation of the composite amplifier, as illustrated in Figure 7. For example, for the 20V_{p-p}/1MHz output condition mentioned above, the 5V rail supply current is 3.75mA, for 1/2 LT6275 the \pm 15V rails supply current is 2.2mA, resulting in a total power dissipation of 85mW.

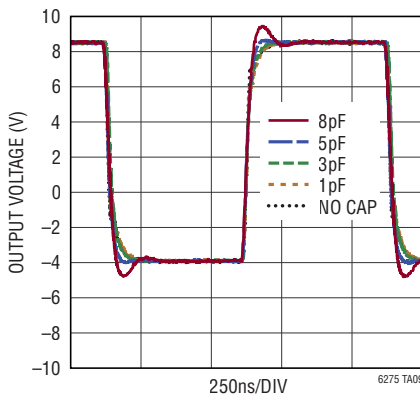

Figure 4. Composite Amplifier Step Response vs LTC6252 Feedback Capacitance ($A_V = -11V/V$)

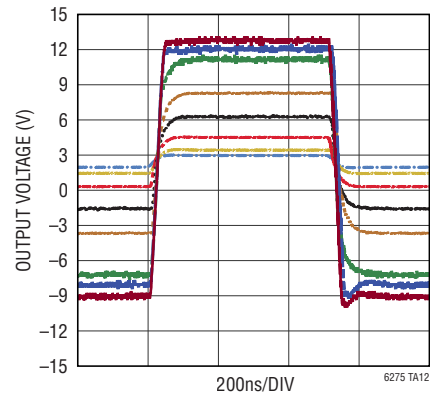

Figure 5. Composite Amplifier Step Response at Various Output Step Amplitudes ($A_V = -11V/V$)

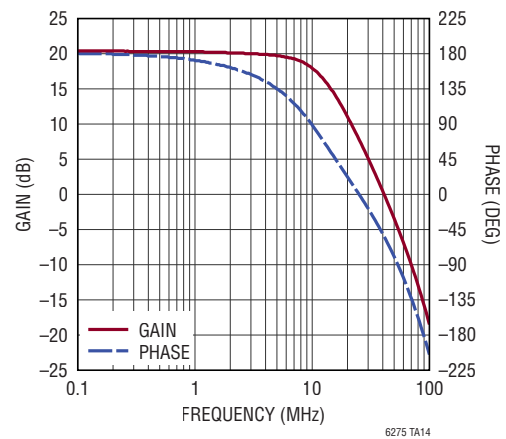

Figure 6. Composite Amplifier Closed-Loop Gain/Phase vs Frequency

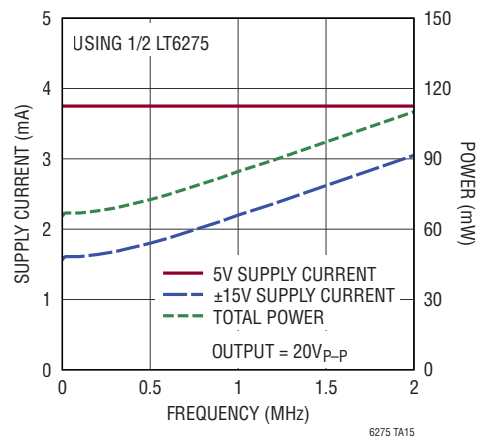
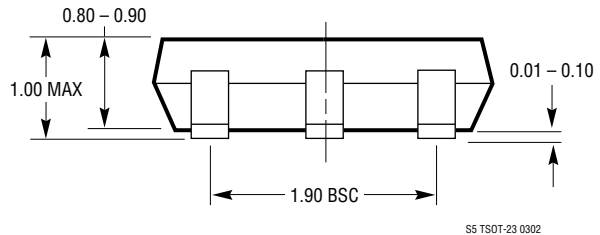
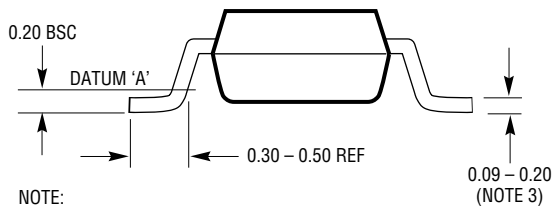
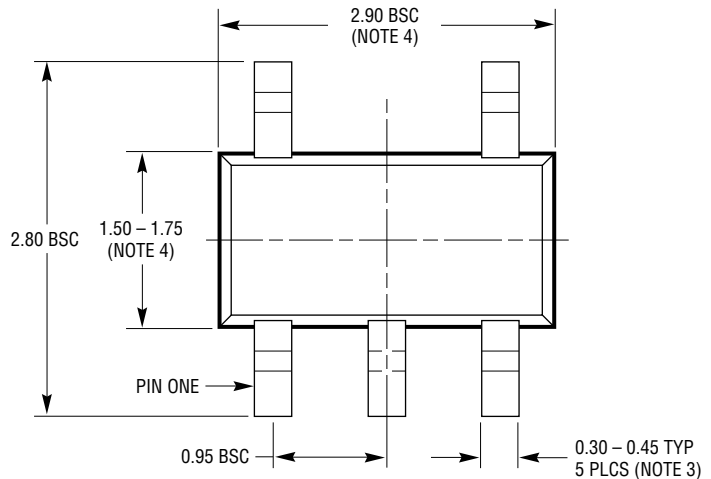
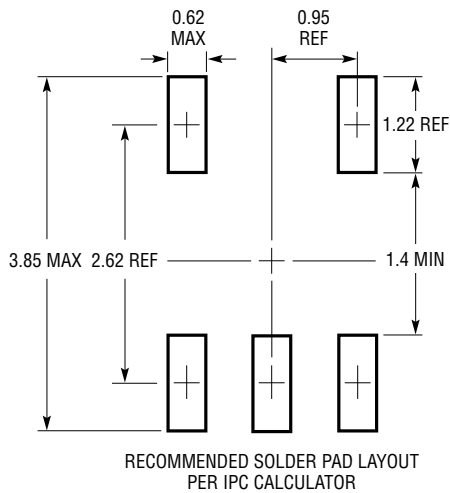

Figure 7. Composite Amplifier Supply Current and Total Power Dissipation

PACKAGE DESCRIPTION

Please refer to <http://www.linear.com/product/LT6274#packaging> for the most recent package drawings.

S5 Package 5-Lead Plastic TSOT-23 (Reference LTC DWG # 05-08-1635)



- NOTE:
1. DIMENSIONS ARE IN MILLIMETERS
 2. DRAWING NOT TO SCALE
 3. DIMENSIONS ARE INCLUSIVE OF PLATING
 4. DIMENSIONS ARE EXCLUSIVE OF MOLD FLASH AND METAL BURR
 5. MOLD FLASH SHALL NOT EXCEED 0.254mm
 6. JEDEC PACKAGE REFERENCE IS MO-193

PACKAGE DESCRIPTION

Please refer to <http://www.linear.com/product/LT6275#packaging> for the most recent package drawings.

MS8 Package 8-Lead Plastic MSOP (Reference LTC DWG # 05-08-1660 Rev G)

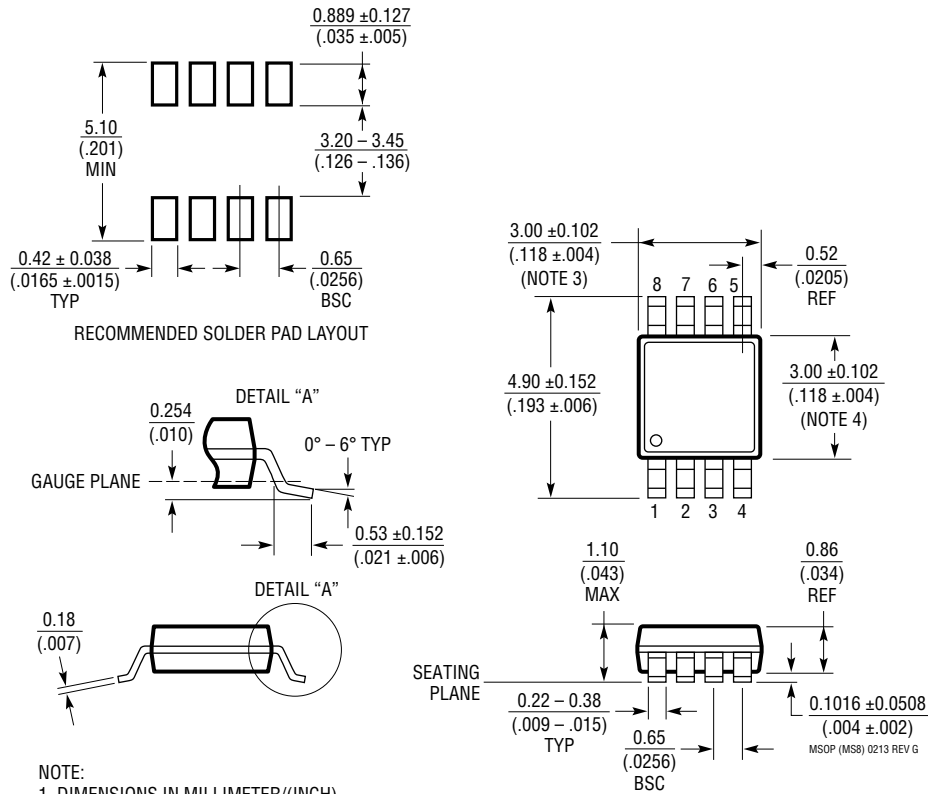

NOTE:

1. DIMENSIONS IN MILLIMETER/(INCH)
2. DRAWING NOT TO SCALE
3. DIMENSION DOES NOT INCLUDE MOLD FLASH, PROTRUSIONS OR GATE BURRS.
MOLD FLASH, PROTRUSIONS OR GATE BURRS SHALL NOT EXCEED 0.152mm (.006") PER SIDE
4. DIMENSION DOES NOT INCLUDE INTERLEAD FLASH OR PROTRUSIONS.
INTERLEAD FLASH OR PROTRUSIONS SHALL NOT EXCEED 0.152mm (.006") PER SIDE
5. LEAD COPLANARITY (BOTTOM OF LEADS AFTER FORMING) SHALL BE 0.102mm (.004") MAX

MSOP (MS8) 0213 REV G

REVISION HISTORY

REV	DATE	DESCRIPTION	PAGE NUMBER
A	12/17	Added LT6274 Updated Power Dissipation section	All 13

TYPICAL APPLICATION

Composite Amplifier Provides 18-Bit Precision and Fast Settling

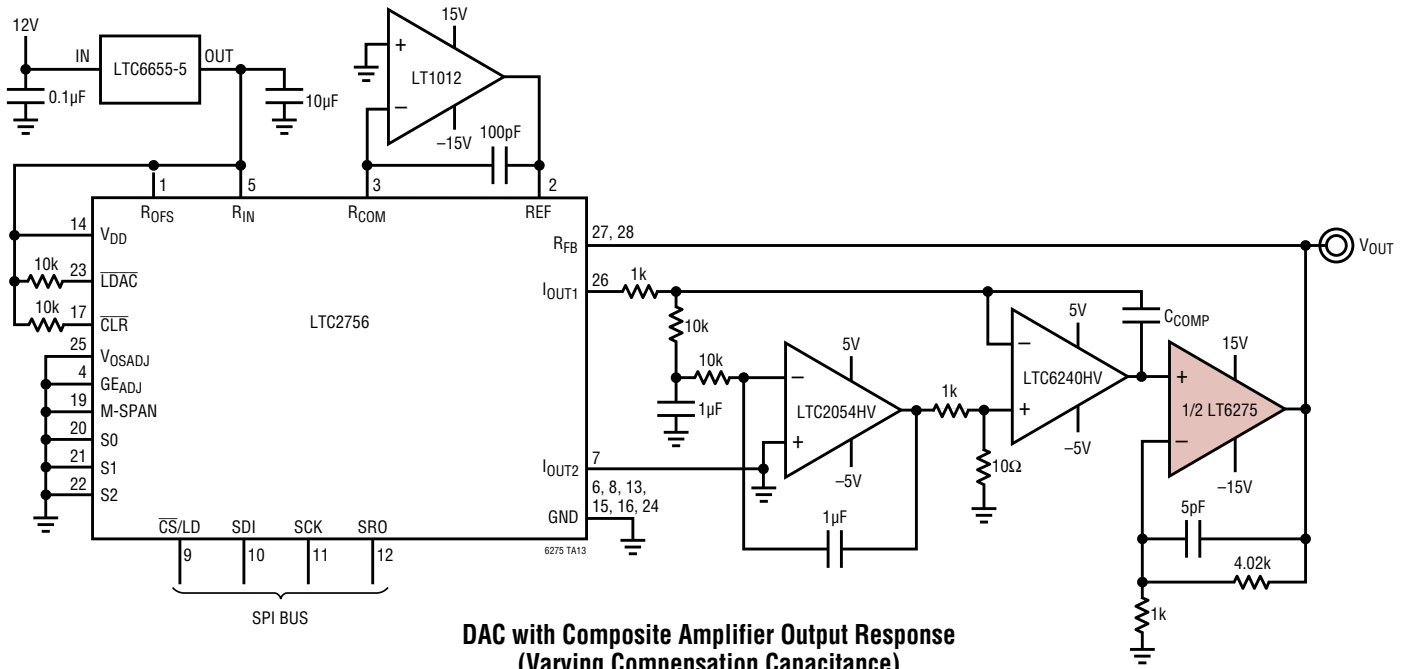

DAC with Composite Amplifier Output Response (Varying Compensation Capacitance)

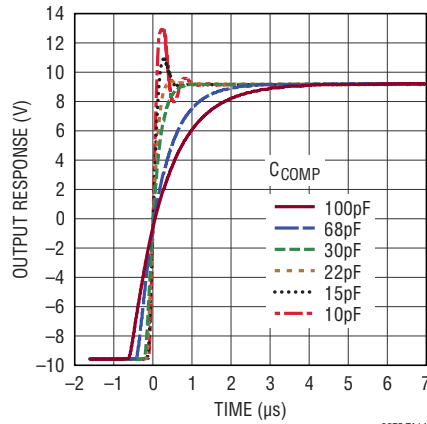

RELATED PARTS

PART NUMBER	DESCRIPTION	COMMENTS
LT1351/LT1352/LT1353	Single/Dual/Quad 3MHz, 200V/μs, C-Load Amplifiers	250μA Supply Current, 600μV Max V _{OS} , 5V to 30V Supply Operation
LT1354/LT1355/LT1356	Single/Dual/Quad 12MHz, 400V/μs, C-Load Amplifiers	1mA Supply Current, 800μV Max V _{OS} , 5V to 30V Supply Operation
LT1357/LT1358/LT1359	Single/Dual/Quad 25MHz, 600V/μs, C-Load Amplifiers	2mA Supply Current, 600μV Max V _{OS} , 5V to 30V Supply Operation
LT1360/LT1361/LT1362	Single/Dual/Quad 50MHz, 800V/μs, C-Load Amplifiers	4mA Supply Current, 1mV Max V _{OS} , 5V to 30V Supply Operation
LT1363/LT1364/LT1365	Single/Dual/Quad 70MHz, 1000V/μs, C-Load Amplifiers	6.3mA Supply Current, 1.5mV Max V _{OS} , 5V to 30V Supply Operation
LT1812/LT1813/LT1814	Single/Dual/Quad 100MHz, 750V/μs Op Amps	3mA Supply Current, 1.5mV Max V _{OS} , 4V to 11V Supply Operation
LTC6261/LTC6262/LTC6263	Single/Dual/Quad 30MHz, 7V/μs Op Amps	240μA Supply Current, 400μV Max V _{OS} , 1.8V to 5.25V Supply Operation
LTC6246/LTC6247/LTC6248	Single/Dual/Quad 180MHz, 90V/μs Op Amps	0.95mA Supply Current, 500μV Max V _{OS} , 2.5V to 5.25V Supply Operation
LTC6252/LTC6253/LTC6254	Single/Dual/Quad 720MHz, 280V/μs Op Amps	3.3mA Supply Current, 350μV Max V _{OS} , 2.5V to 5.25V Supply Operation

Looking for pricing, stock, or lifecycle information?

Click below to explore more details on WIN SOURCE:

 [View LT6274IS5#TRMPBF on WIN SOURCE](#)

 [Analog Devices Inc. Information](#)

Optimize Your Supply Chain with WIN SOURCE Solutions

-  Global Sourcing Solution
-  Obsolete Management
-  Cost Control Management
-  Shortage Management
-  Alternative Solution
-  Excess Inventory Management