



**THE DATASHEET OF  
NCP4682DSQ25T1G**



# NCP4682, NCP4685

## 150 mA, Ultra Low Supply Current, Low Dropout Regulator

The NCP4682 and NCP4685 are CMOS Low Dropout Linear voltage regulators with 150 mA output current capability. The devices have high output voltage accuracy, a 1  $\mu$ A (typ.) ultra low supply current and high ripple rejection. Current fold-back protection is integrated in the devices to protect against over current and short current conditions. A Chip Enable (NCP4682 only) function is included to save power by further lowering supply current, which is advantageous for battery powered applications. The NCP4685 is optimized for the lowest quiescent current possible in applications where the device is always on.

### Features

- Operating Input Voltage Range: 1.70 V to 5.25 V
- Output Voltage Range: 1.2 V to 3.3 V (available in 0.1 V steps)
- Output Voltage Accuracy:  $\pm 0.8\%$
- Excellent Output Voltage Temperature Coefficient :  $\pm 40$  ppm/ $^{\circ}$ C
- Supply Current: 1.0  $\mu$ A (excluding CE pull down current)
- Standby Current: 0.1  $\mu$ A
- Dropout Voltage: 0.24 V ( $I_{OUT} = 150$  mA,  $V_{OUT} = 2.8$  V)
- Line Regulation: 0.02%/V Typ.
- Stable with Ceramic Capacitors: 0.1  $\mu$ F or more
- Current Fold Back Protection
- Available in UDFN4 1.0 x 1.0 mm, SC-82AB, SOT23 Packages
- These are Pb-Free Devices

### Typical Applications

- Battery-Powered Equipment
- Networking and Communication Equipment
- Cameras, DVRs, STB and Camcorders
- Home Appliances

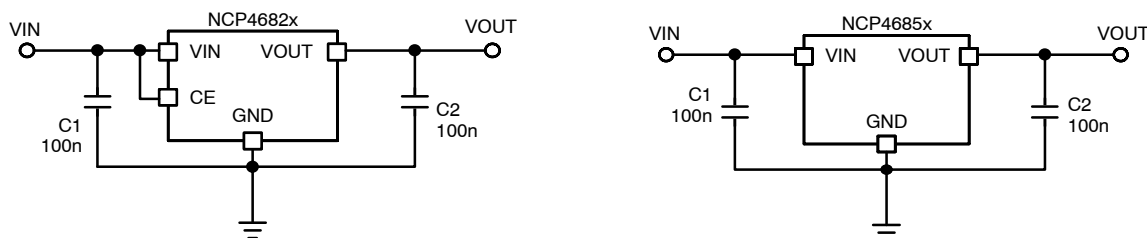

Figure 1. Typical Application Schematics



ON Semiconductor™

<http://onsemi.com>

### MARKING DIAGRAMS

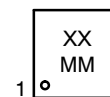
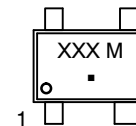
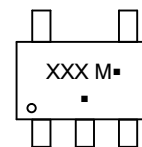

XXX, XX = Specific Device Code  
M, MM = Date Code  
▪ = Pb-Free Package

(\*Note: Microdot may be in either location)

### ORDERING INFORMATION

See detailed ordering, marking and shipping information in the package dimensions section on page 19 of this data sheet.

## NCP4682, NCP4685

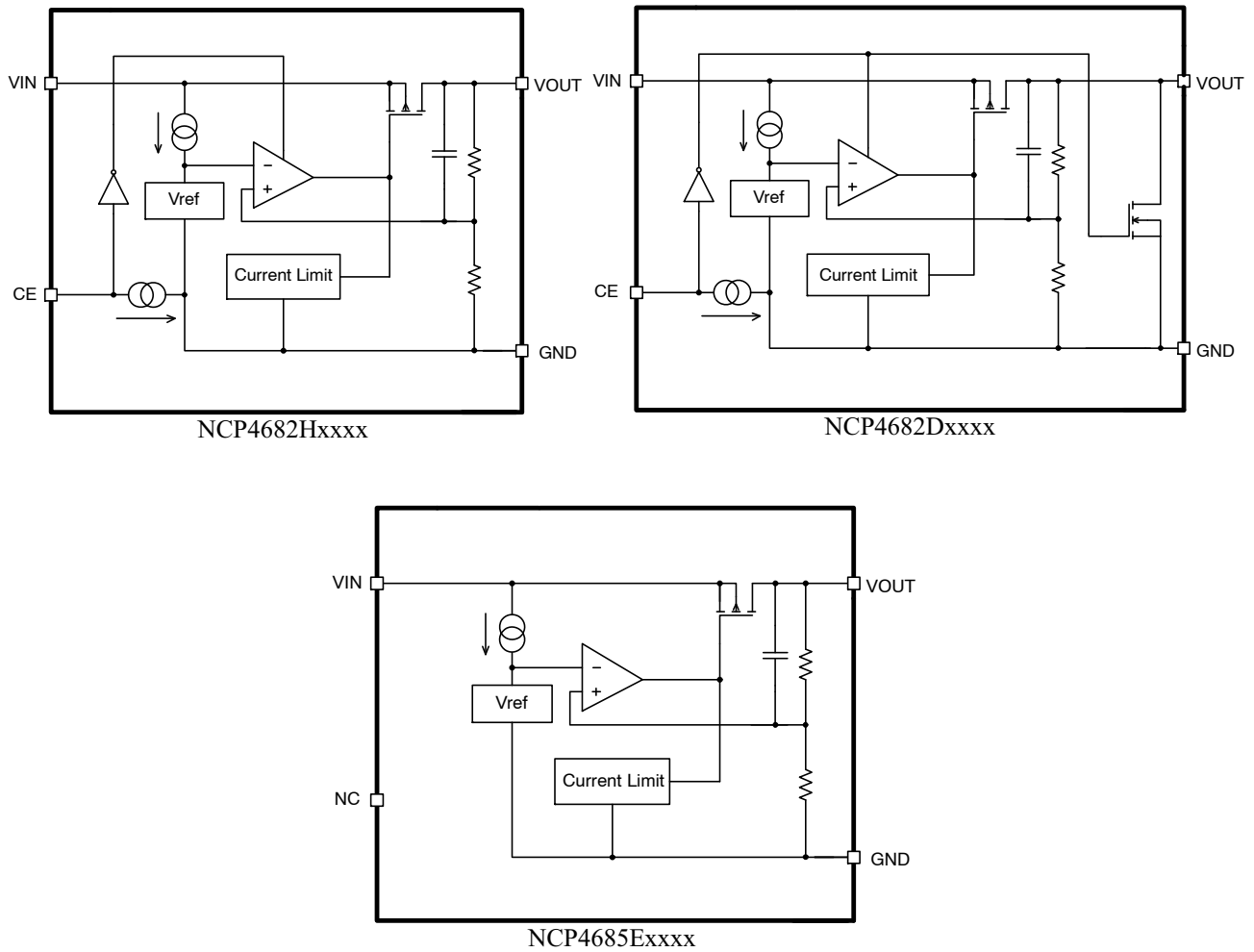

**Figure 2. Simplified Schematic Block Diagram**

### PIN FUNCTION DESCRIPTION

Pin No. UDFN1010*	Pin No. SC-82AB	Pin No. SOT23	Pin Name	Description
1	3	5	V <sub>OUT</sub>	Output pin
2	2	2	GND	Ground
3	1	3	CE/NC	Chip enable pin (Active "H") / No connection
4	4	1	V <sub>IN</sub>	Input pin
-	-	4	NC	No connection

\*Tab is GND level. (They are connected to the reverse side of this IC.)  
The tab is better to be connected to the GND, but leaving it open is also acceptable.

### ABSOLUTE MAXIMUM RATINGS

Rating	Symbol	Value	Unit
Input Voltage (Note 1)	V <sub>IN</sub>	6.0	V
Output Voltage	V <sub>OUT</sub>	-0.3 to V <sub>IN</sub> + 0.3	V
Chip Enable Input	V <sub>CE</sub>	6.0	V
Output Current	I <sub>OUT</sub>	200	mA

# NCP4682, NCP4685

## ABSOLUTE MAXIMUM RATINGS

Rating	Symbol	Value	Unit
Power Dissipation UDFN1010	P <sub>D</sub>	400	mW
Power Dissipation SC-82AB		380	
Power Dissipation SOT23		420	
Junction Temperature	T <sub>J</sub>	-40 to 150	°C
Storage Temperature	T <sub>STG</sub>	-55 to 125	°C
ESD Capability, Human Body Model (Note 2)	ESD <sub>HBM</sub>	2000	V
ESD Capability, Machine Model (Note 2)	ESD <sub>MM</sub>	200	V

Stresses exceeding Maximum Ratings may damage the device. Maximum Ratings are stress ratings only. Functional operation above the Recommended Operating Conditions is not implied. Extended exposure to stresses above the Recommended Operating Conditions may affect device reliability.

- Refer to ELECTRICAL CHARACTERISTICS and APPLICATION INFORMATION for Safe Operating Area.
- This device series incorporates ESD protection and is tested by the following methods:  
 ESD Human Body Model tested per AEC-Q100-002 (EIA/JESD22-A114)  
 ESD Machine Model tested per AEC-Q100-003 (EIA/JESD22-A115)  
 Latchup Current Maximum Rating tested per JEDEC standard: JESD78.

## THERMAL CHARACTERISTICS

Rating	Symbol	Value	Unit
Thermal Characteristics, UDFN 1.0 x 1.0 mm Thermal Resistance, Junction-to-Air	R <sub>θJA</sub>	250	°C/W
Thermal Characteristics, SOT23 Thermal Resistance, Junction-to-Air	R <sub>θJA</sub>	238	°C/W
Thermal Characteristics, SC-82AB Thermal Resistance, Junction-to-Air	R <sub>θJA</sub>	263	°C/W

## ELECTRICAL CHARACTERISTICS

-40°C ≤ T<sub>A</sub> ≤ 85°C; V<sub>IN</sub> = V<sub>OUT(NOM)</sub> + 1 V or 2.5 V, whichever is greater; I<sub>OUT</sub> = 1 mA, C<sub>IN</sub> = C<sub>OUT</sub> = 0.1 μF, unless otherwise noted.  
 Typical values are at T<sub>A</sub> = +25°C.

Parameter	Test Conditions	Symbol	Min	Typ	Max	Unit	
Operating Input Voltage	(Note 3)	V <sub>IN</sub>	1.70		5.25	V	
Output Voltage	T <sub>A</sub> = +25 °C	V <sub>OUT</sub> ≥ 2.0 V	x0.992		x1.008	V	
							V <sub>OUT</sub> < 2.0 V
	-40°C ≤ T <sub>A</sub> ≤ 85°C	V <sub>OUT</sub> ≥ 2.0 V	x0.985		x1.015	V	
							V <sub>OUT</sub> < 2.0 V
Output Voltage Temp. Coefficient	-40°C ≤ T <sub>A</sub> ≤ 85°C	ΔV <sub>OUT</sub> / ΔT <sub>A</sub>		±40		ppm/°C	
Line Regulation	V <sub>OUT(NOM)</sub> + 0.5 V ≤ V <sub>IN</sub> ≤ 5.0 V	Line <sub>Reg</sub>		0.02	0.10	%/V	
Load Regulation	I <sub>OUT</sub> = 1 mA to 150 mA	Load <sub>Reg</sub>		10	20	mV	
Dropout Voltage	I <sub>OUT</sub> = 150 mA	1.2 V ≤ V <sub>OUT</sub> < 1.5 V	V <sub>DO</sub>		0.76	1.05	V
		1.5 V ≤ V <sub>OUT</sub> < 1.7 V			0.53	0.80	
		1.7 V ≤ V <sub>OUT</sub> < 2.0 V			0.44	0.65	
		2.0 V ≤ V <sub>OUT</sub> < 2.5 V			0.34	0.50	
		2.5 V ≤ V <sub>OUT</sub> < 2.8 V			0.28	0.40	
		2.8 V ≤ V <sub>OUT</sub> < 3.3 V			0.24	0.32	
Output Current		I <sub>OUT</sub>	150			mA	
Short Current Limit	V <sub>OUT</sub> = 0 V	I <sub>SC</sub>		40		mA	
Quiescent Current		I <sub>Q</sub>		1.0	1.5	μA	

## NCP4682, NCP4685

### ELECTRICAL CHARACTERISTICS

$-40^{\circ}\text{C} \leq T_A \leq 85^{\circ}\text{C}$ ;  $V_{IN} = V_{OUT(NOM)} + 1\text{ V}$  or  $2.5\text{ V}$ , whichever is greater;  $I_{OUT} = 1\text{ mA}$ ,  $C_{IN} = C_{OUT} = 0.1\text{ }\mu\text{F}$ , unless otherwise noted. Typical values are at  $T_A = +25^{\circ}\text{C}$ .

Parameter	Test Conditions	Symbol	Min	Typ	Max	Unit
Standby Current	$V_{CE} = 0\text{ V}$ , $T_A = 25^{\circ}\text{C}$ , NCP4682 only	$I_{STB}$		0.1	1.0	$\mu\text{A}$
CE Pin Threshold Voltage (NCP4682 only)	CE Input Voltage "H"	$V_{CEH}$	1.5			V
	CE Input Voltage "L"	$V_{CEL}$			0.3	
CE Pull Down Current	NCP4682 only	$I_{CEPD}$		0.3		$\mu\text{A}$
Power Supply Rejection Ratio	$V_{IN} = 2.2\text{ V}$ , $V_{OUT} = 1.2\text{ V}$ , $\Delta V_{IN} = 0.2\text{ V}_{pk-pk}$ , $I_{OUT} = 30\text{ mA}$ , $f = 1\text{ kHz}$	PSRR		30		dB
Output Noise Voltage	$f = 10\text{ Hz}$ to $100\text{ kHz}$ , $I_{OUT} = 30\text{ mA}$ , $V_{OUT} = 1.2\text{ V}$ , $V_{IN} = 2.2\text{ V}$	$V_N$		70		$\mu\text{V}_{rms}$
Low Output Nch Tr. On Resistance	$V_{IN} = 4\text{ V}$ , $V_{CE} = 0\text{ V}$ , NCP4682D only	$R_{LOW}$		30		$\Omega$

3. The maximum Input Voltage of the Electrical Characteristics is 5.25 V. In case of exceeding this specification, the IC must be operated in condition that the Input Voltage is up to 5.50 V and total operation time is within 500 hours.

TYPICAL CHARACTERISTICS

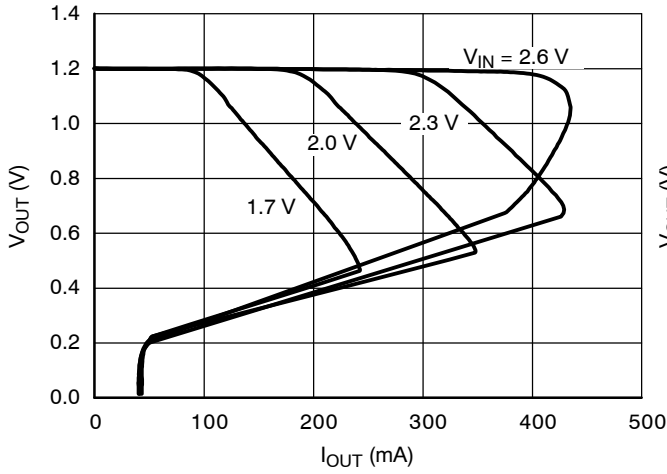

Figure 3. Output Voltage vs. Output Current  
1.2 V Version ( $T_J = 25^\circ\text{C}$ )

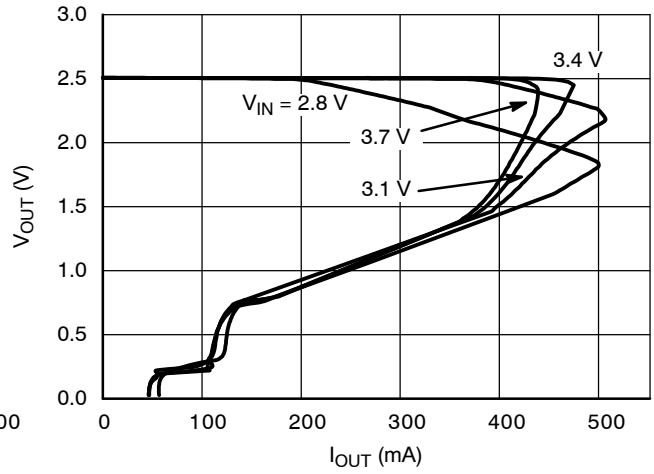

Figure 4. Output Voltage vs. Output Current  
2.5 V Version ( $T_J = 25^\circ\text{C}$ )

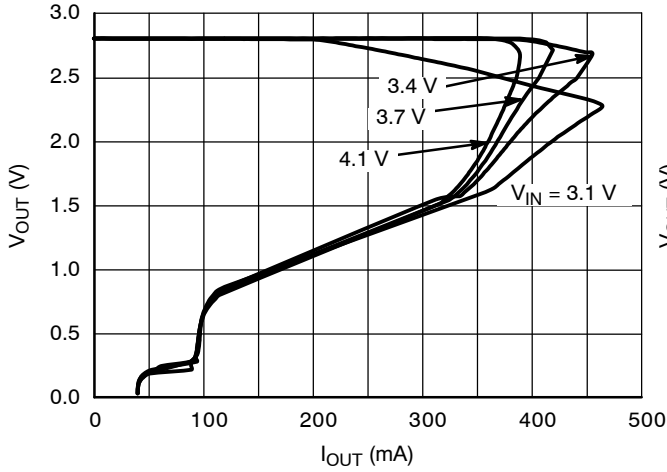

Figure 5. Output Voltage vs. Output Current  
2.8 V Version ( $T_J = 25^\circ\text{C}$ )

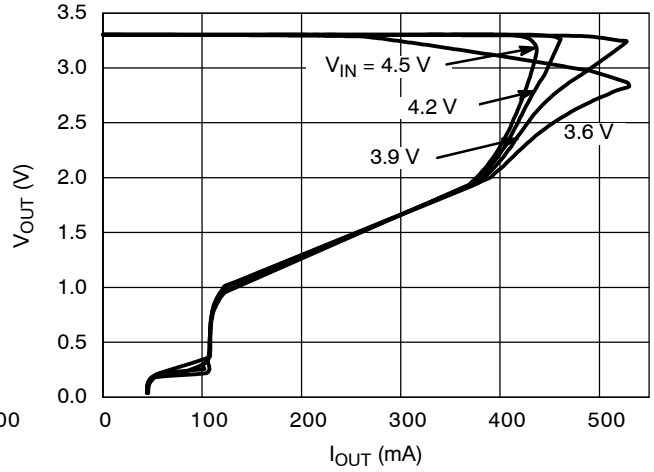

Figure 6. Output Voltage vs. Output Current  
3.3 V Version ( $T_J = 25^\circ\text{C}$ )

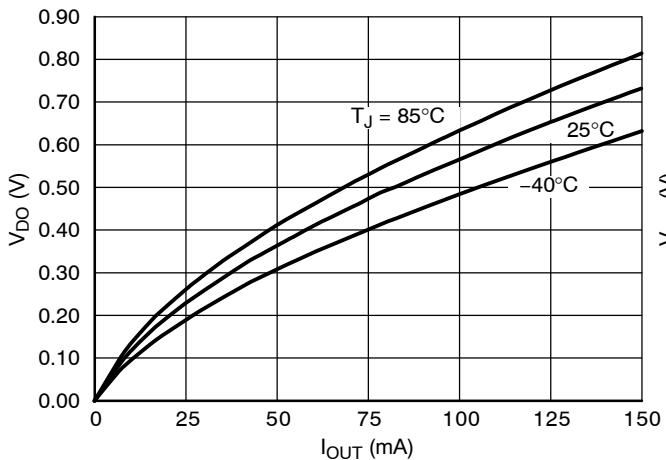

Figure 7. Dropout Voltage vs. Output Current  
1.2 V Version

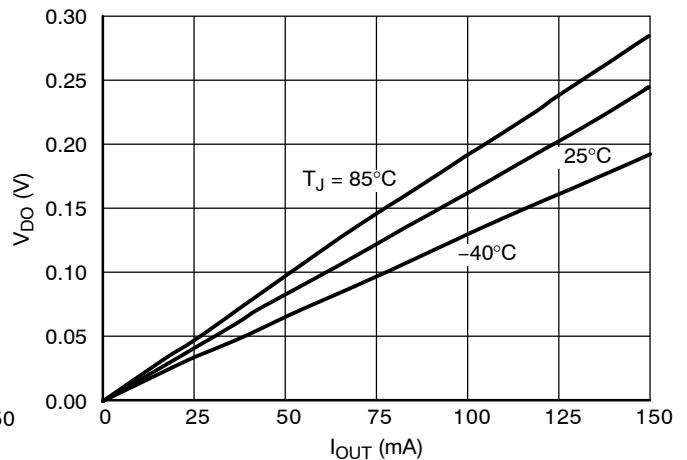
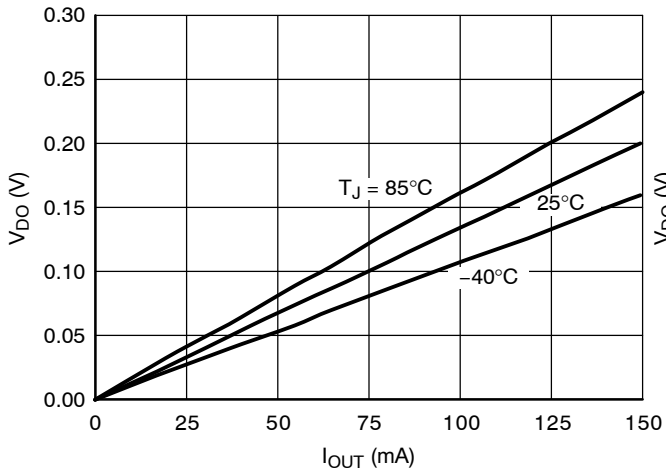

Figure 8. Dropout Voltage vs. Output Current  
2.5 V Version

# NCP4682, NCP4685

## TYPICAL CHARACTERISTICS



**Figure 9. Dropout Voltage vs. Output Current  
2.8 V Version**

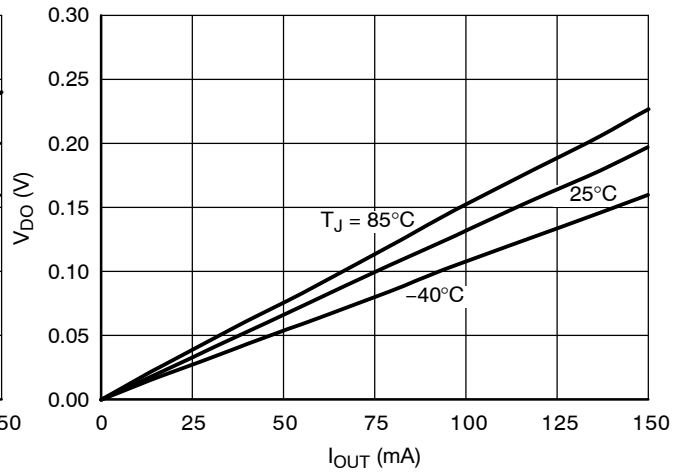

**Figure 10. Dropout Voltage vs. Output Current  
3.3 V Version**

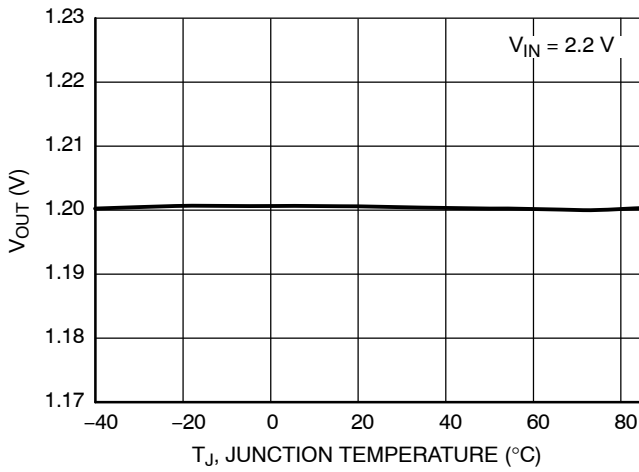

**Figure 11. Output Voltage vs. Temperature,  
1.2 V Version**

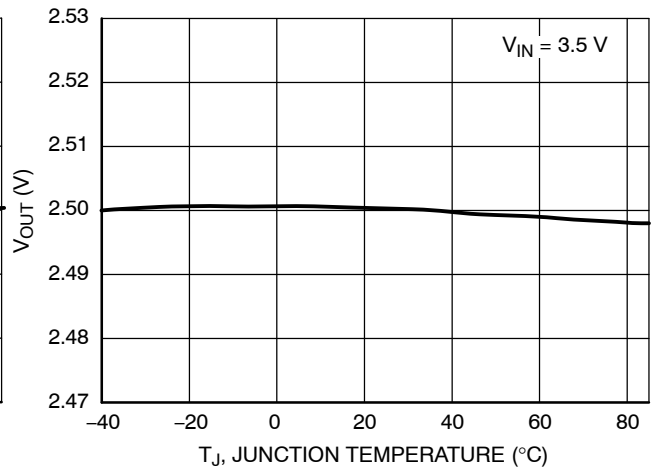

**Figure 12. Output Voltage vs. Temperature,  
2.5 V Version**

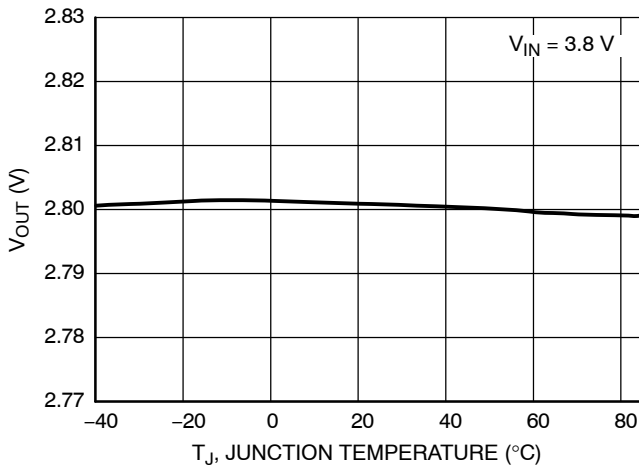

**Figure 13. Output Voltage vs. Temperature,  
2.8 V Version**

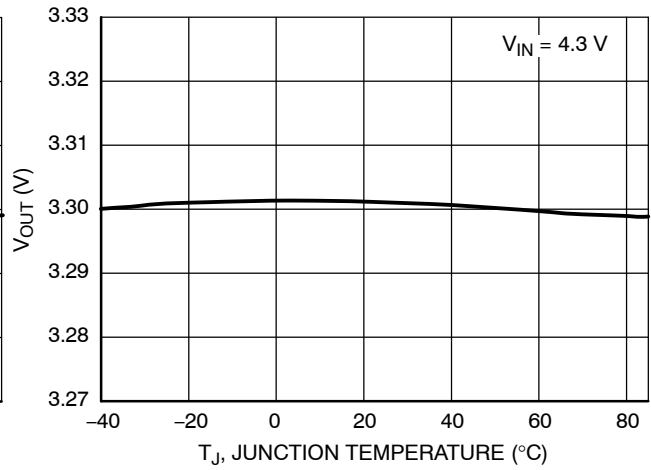

**Figure 14. Output Voltage vs. Temperature,  
3.3 V Version**

# NCP4682, NCP4685

## TYPICAL CHARACTERISTICS

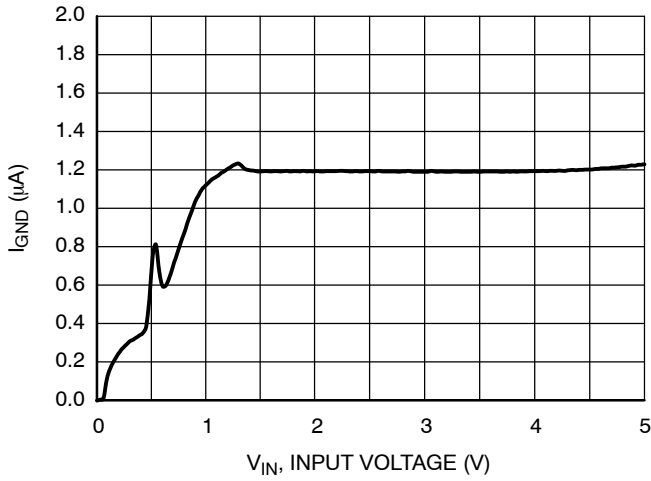

Figure 15. Supply Current vs. Input Voltage, 1.2 V Version

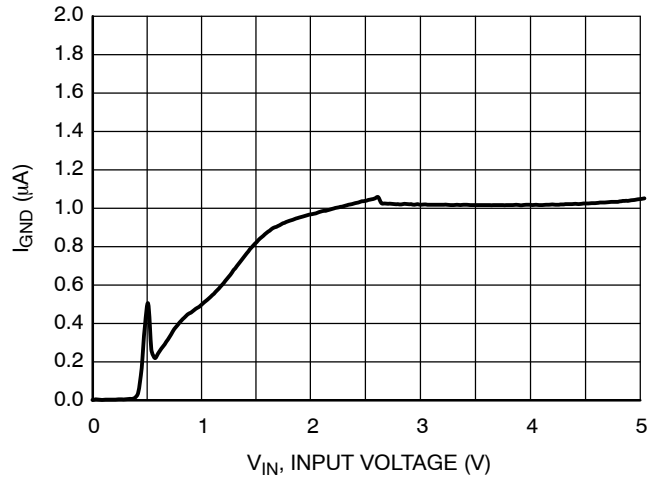

Figure 16. Supply Current vs. Input Voltage, 2.5 V Version

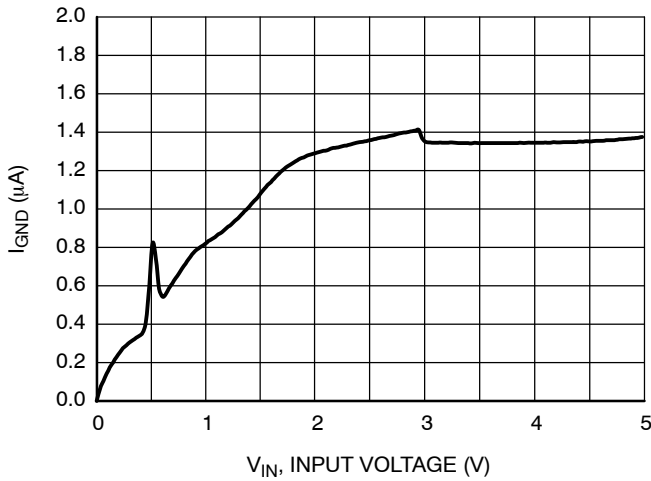

Figure 17. Supply Current vs. Input Voltage, 2.8 V Version

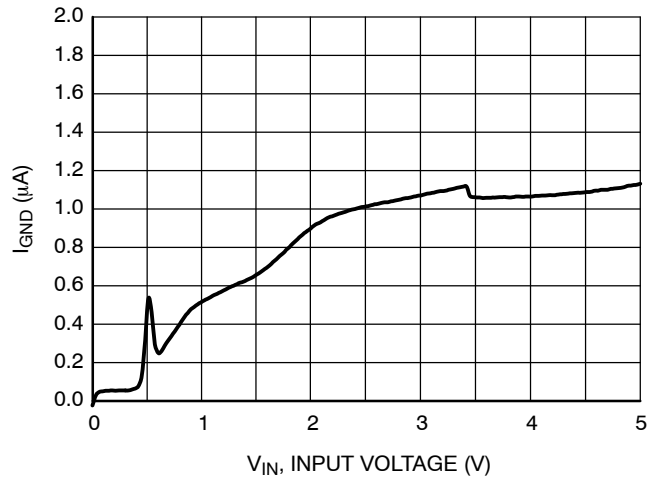

Figure 18. Supply Current vs. Input Voltage, 3.3 V Version

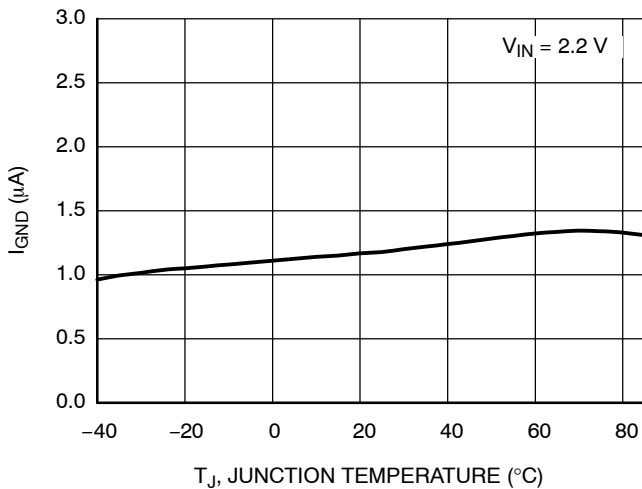

Figure 19. Supply Current vs. Temperature, 1.2 V Version

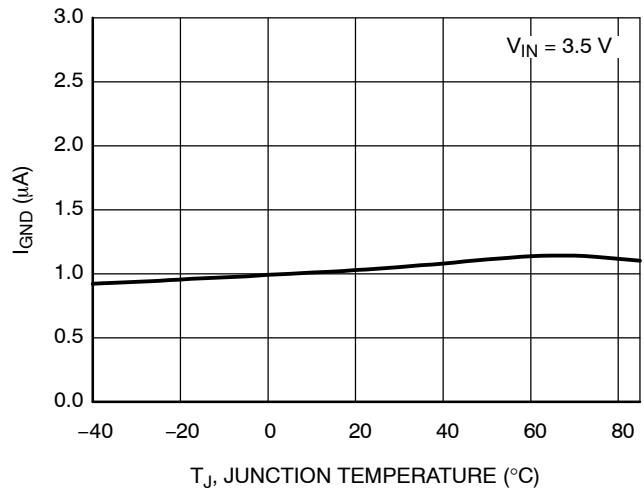
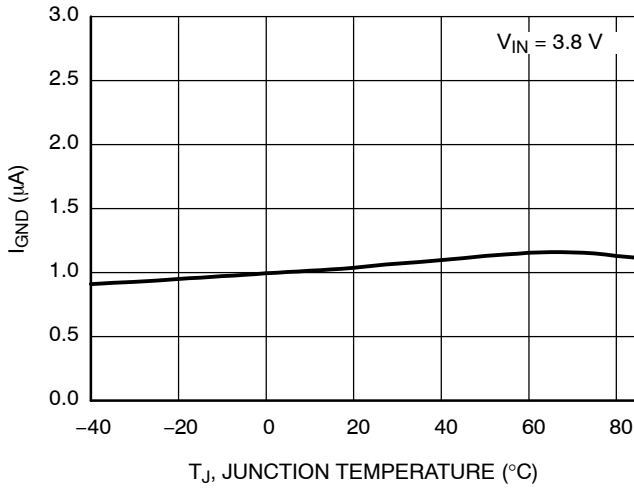

Figure 20. Supply Current vs. Temperature, 2.5 V Version

# NCP4682, NCP4685

## TYPICAL CHARACTERISTICS



**Figure 21. Supply Current vs. Temperature, 2.8 V Version**

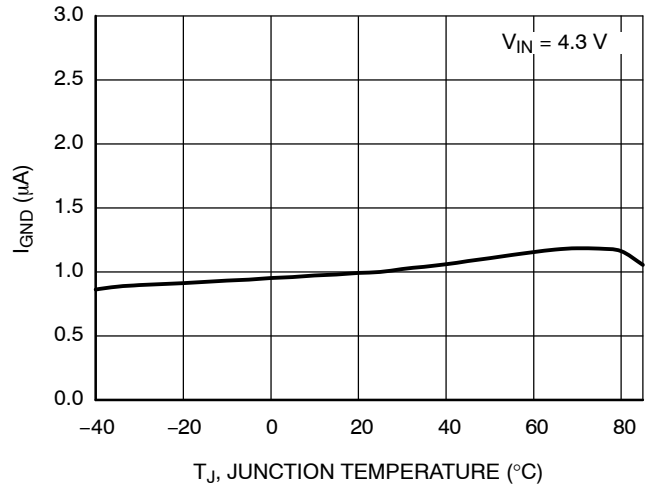

**Figure 22. Supply Current vs. Temperature, 3.3 V Version**

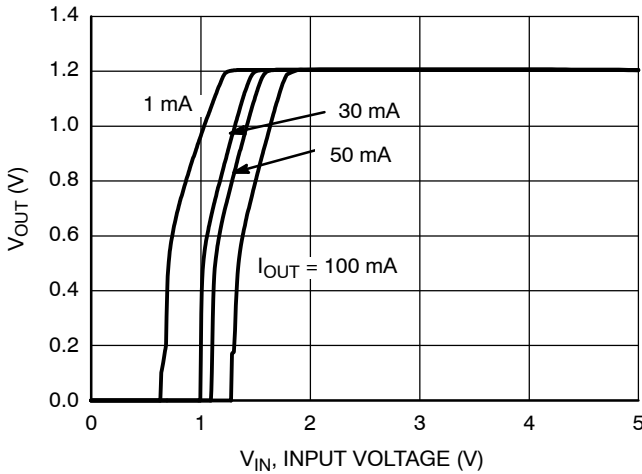

**Figure 23. Output Voltage vs. Input Voltage, 1.2 V Version**

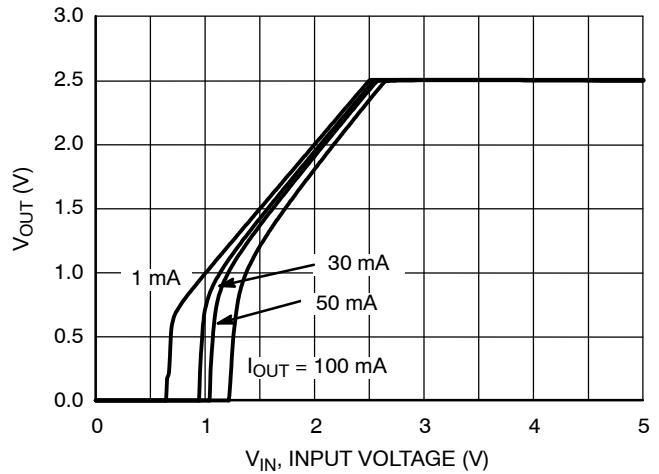

**Figure 24. Output Voltage vs. Input Voltage, 2.5 V Version**

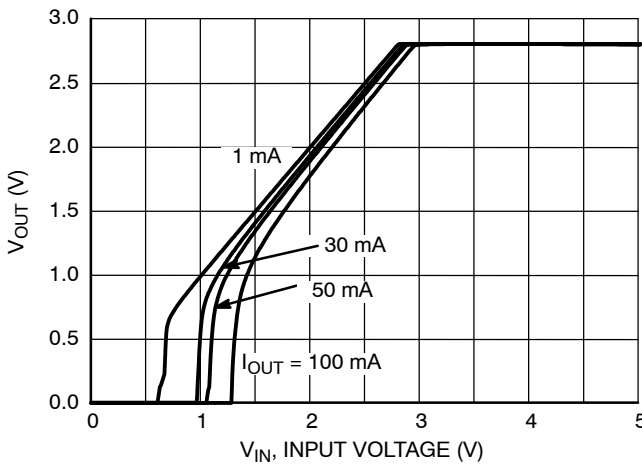

**Figure 25. Output Voltage vs. Input Voltage, 2.8 V Version**

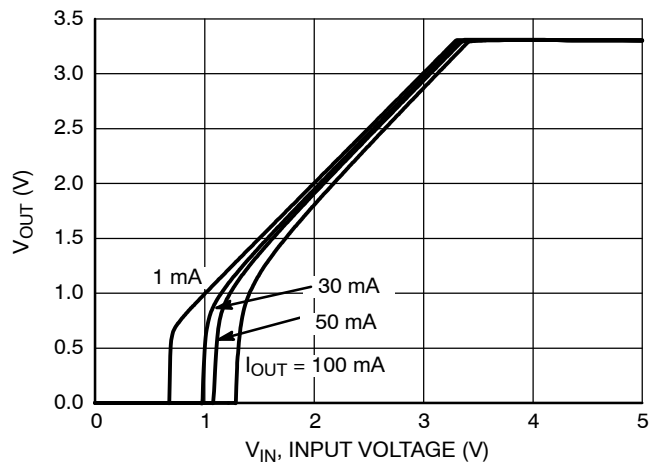

**Figure 26. Output Voltage vs. Input Voltage, 3.3 V Version**

TYPICAL CHARACTERISTICS

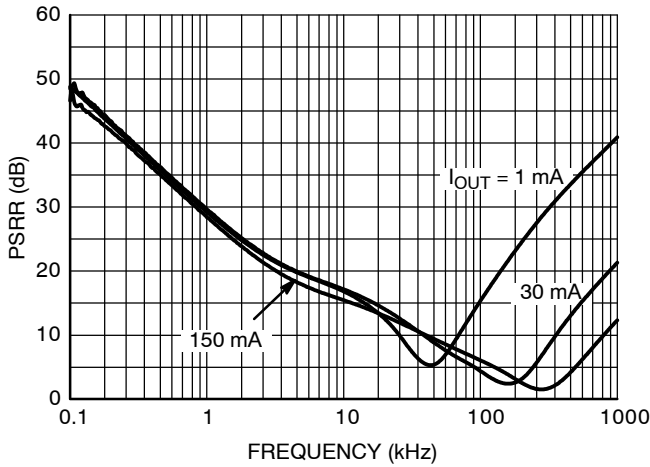

Figure 27. PSRR, 1.2 V Version,  $V_{IN} = 2.2 V$

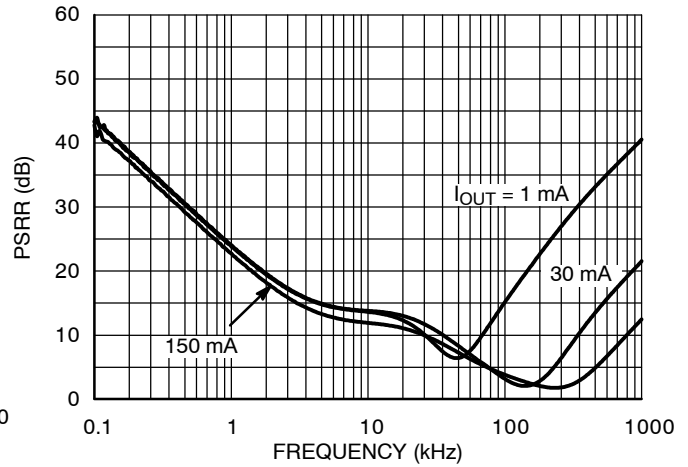

Figure 28. PSRR, 2.5 V Version,  $V_{IN} = 3.5 V$

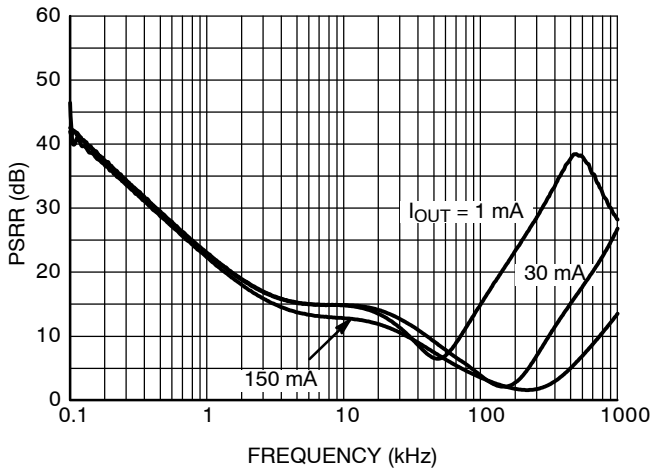

Figure 29. PSRR, 2.8 V Version,  $V_{IN} = 3.8 V$

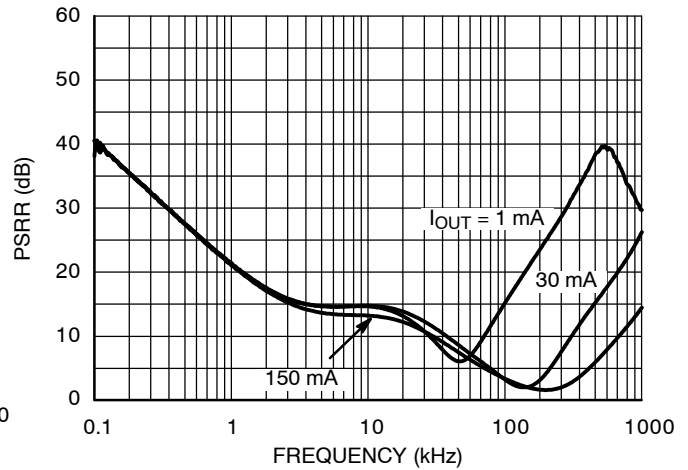

Figure 30. PSRR, 3.3 V Version,  $V_{IN} = 4.3 V$

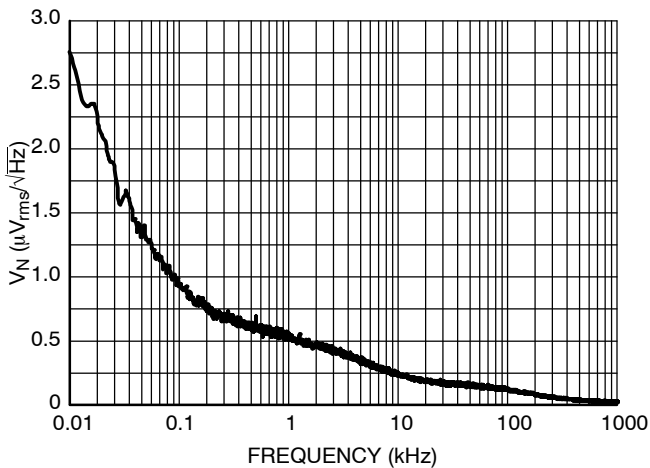

Figure 31. Output Voltage Noise, 1.2 V Version,  $V_{IN} = 2.2 V$ ,  $I_{OUT} = 30 mA$

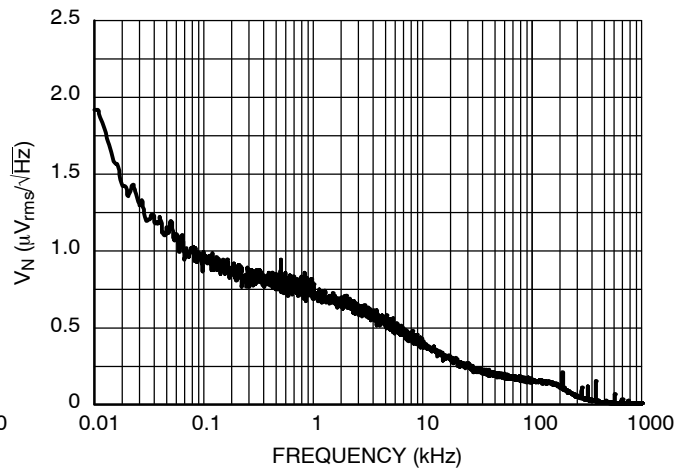

Figure 32. Output Voltage Noise, 2.5 V Version,  $V_{IN} = 3.5 V$ ,  $I_{OUT} = 30 mA$

# NCP4682, NCP4685

## TYPICAL CHARACTERISTICS

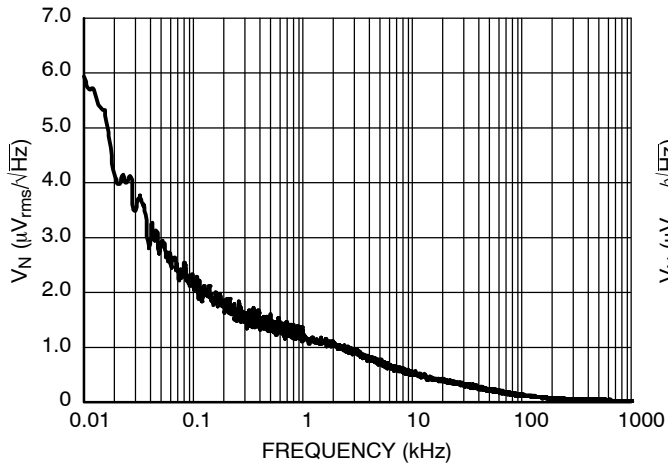

Figure 33. Output Voltage Noise, 2.8 V Version,  
 $V_{IN} = 3.8 \text{ V}$ ,  $I_{OUT} = 30 \text{ mA}$

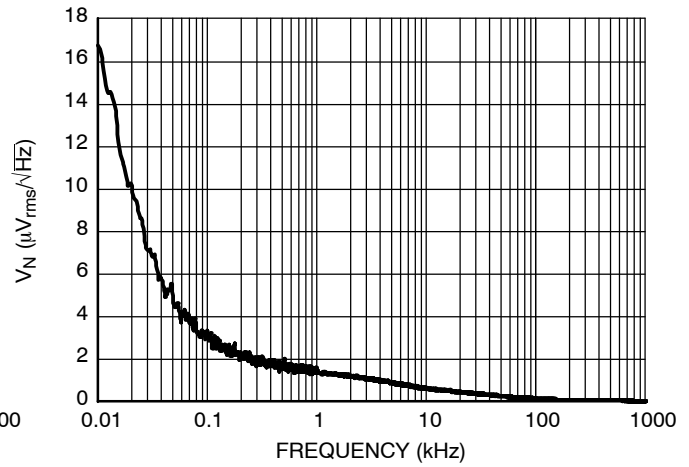

Figure 34. Output Voltage Noise, 3.3 V Version,  
 $V_{IN} = 4.3 \text{ V}$ ,  $I_{OUT} = 30 \text{ mA}$

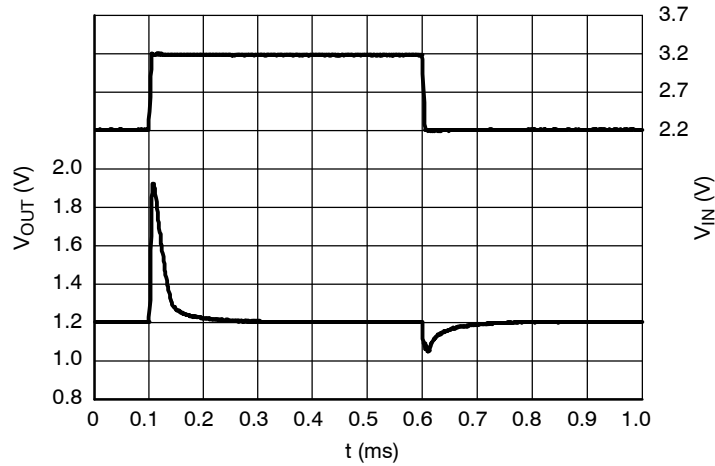

Figure 35. Line Transients, 1.2 V Version,  
 $t_R = t_F = 5 \mu\text{s}$ ,  $I_{OUT} = 30 \text{ mA}$

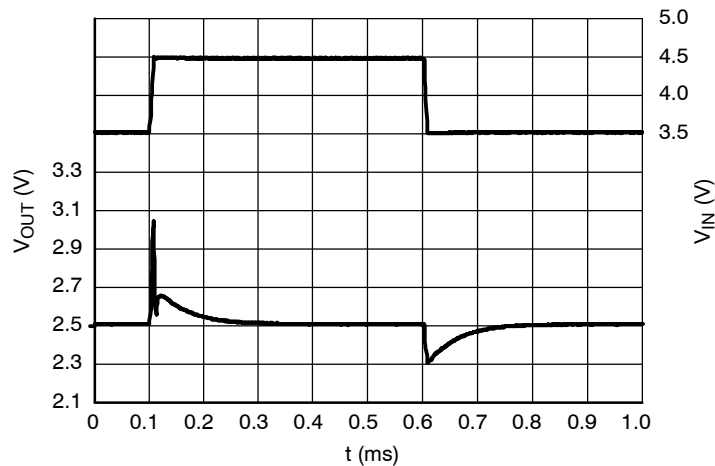

Figure 36. Line Transients, 2.5 V Version,  
 $t_R = t_F = 5 \mu\text{s}$ ,  $I_{OUT} = 30 \text{ mA}$

# NCP4682, NCP4685

## TYPICAL CHARACTERISTICS

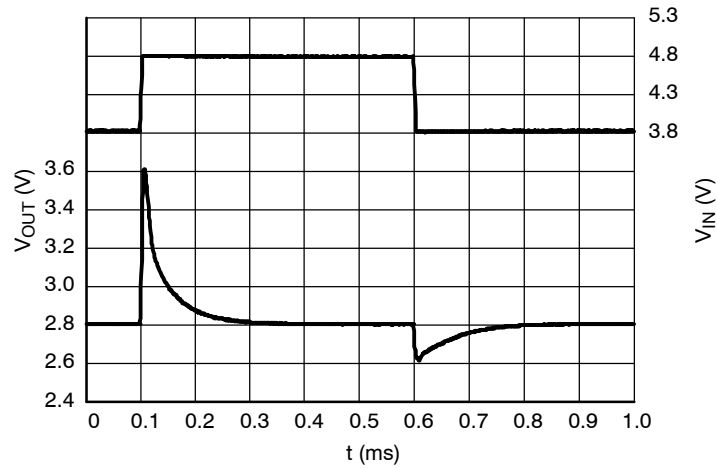

Figure 37. Line Transients, 2.8 V Version,  
 $t_R = t_F = 5 \mu s$ ,  $I_{OUT} = 30 \text{ mA}$

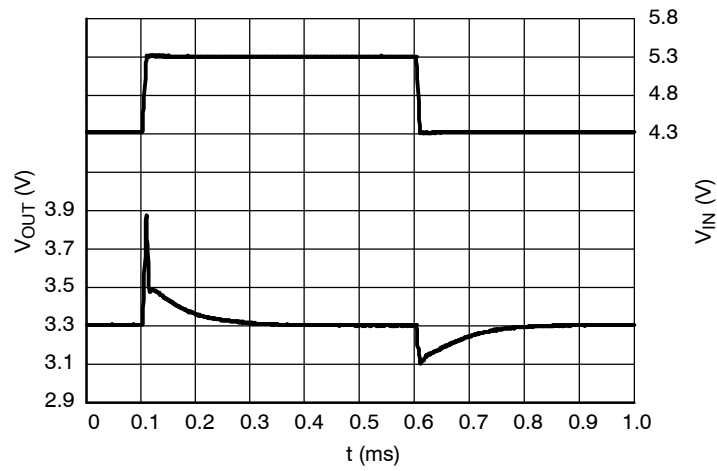

Figure 38. Line Transients, 3.3 V Version,  
 $t_R = t_F = 5 \mu s$ ,  $I_{OUT} = 30 \text{ mA}$

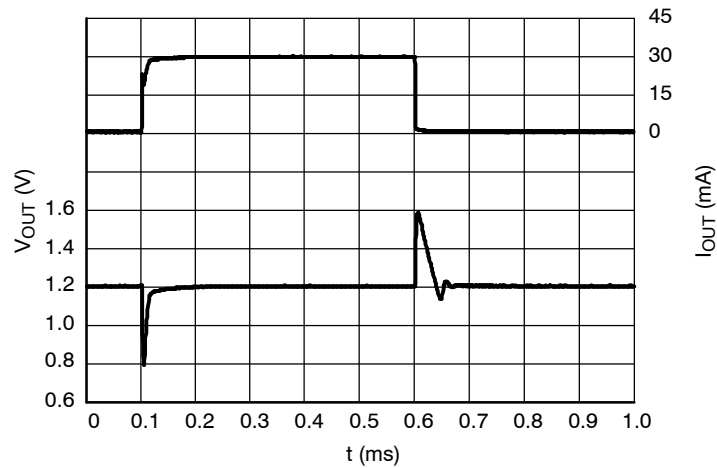
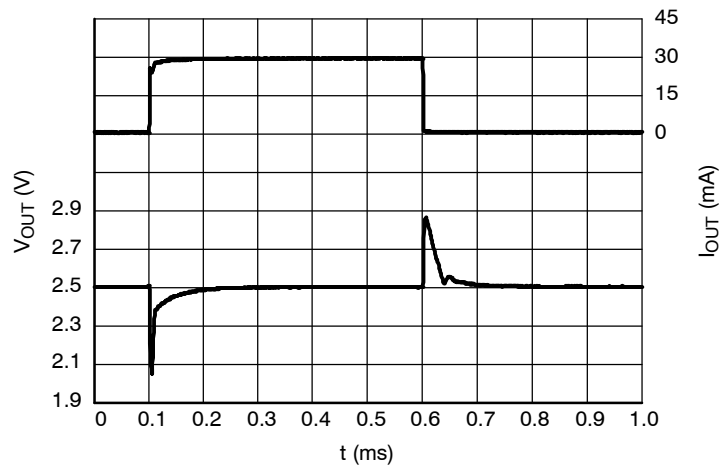

Figure 39. Load Transients, 1.2 V Version,  
 $I_{OUT} = 1 - 30 \text{ mA}$ ,  $t_R = t_F = 0.5 \mu s$ ,  $V_{IN} = 2.2 \text{ V}$

# NCP4682, NCP4685

## TYPICAL CHARACTERISTICS



**Figure 40. Load Transients, 2.5 V Version,  
 $I_{OUT} = 1 - 30$  mA,  $t_R = t_F = 0.5$   $\mu$ s,  $V_{IN} = 3.5$  V**

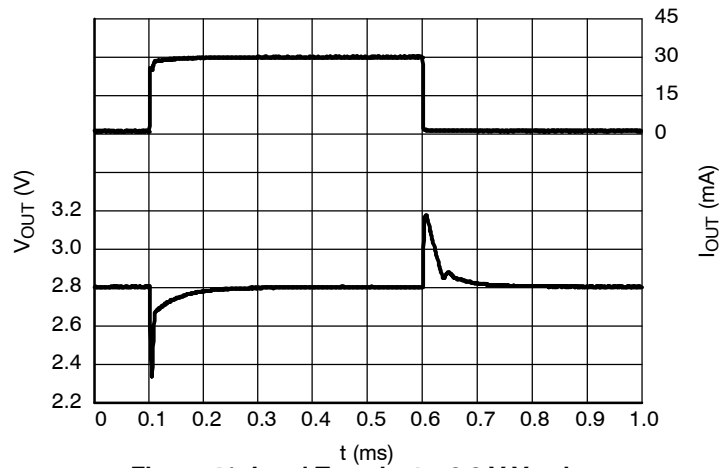

**Figure 41. Load Transients, 2.8 V Version,  
 $I_{OUT} = 1 - 30$  mA,  $t_R = t_F = 0.5$   $\mu$ s,  $V_{IN} = 3.8$  V**

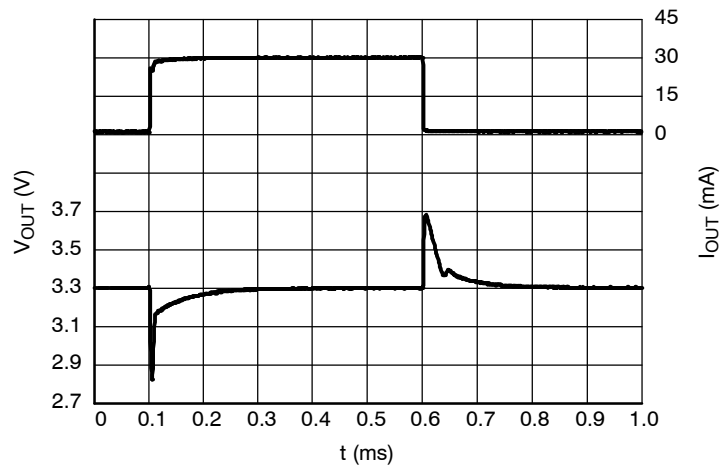

**Figure 42. Load Transients, 3.3 V Version,  
 $I_{OUT} = 1 - 30$  mA,  $t_R = t_F = 0.5$   $\mu$ s,  $V_{IN} = 4.3$  V**

# NCP4682, NCP4685

## TYPICAL CHARACTERISTICS

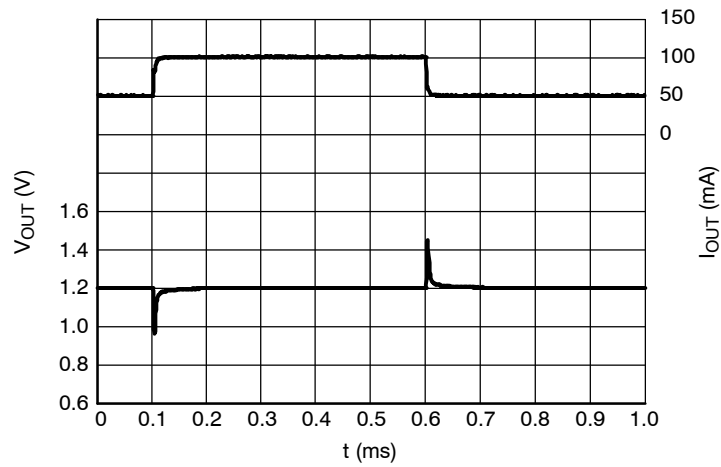

**Figure 43. Load Transients, 1.2 V Version,  
 $I_{OUT} = 50 - 100 \text{ mA}$ ,  $t_R = t_F = 0.5 \mu\text{s}$ ,  $V_{IN} = 2.2 \text{ V}$**

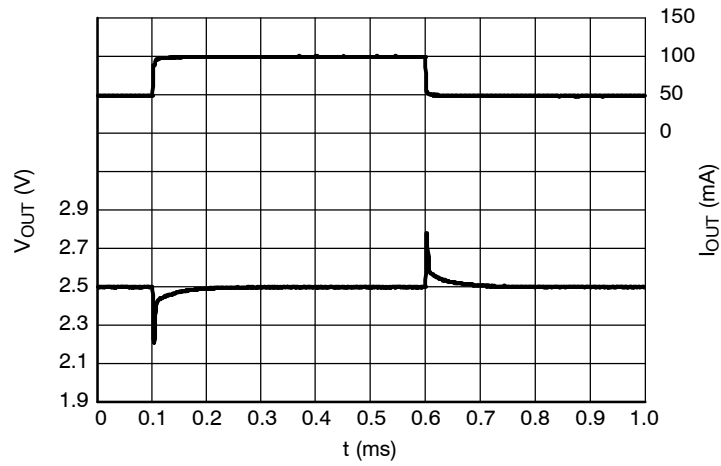

**Figure 44. Load Transients, 2.5 V Version,  
 $I_{OUT} = 50 - 100 \text{ mA}$ ,  $t_R = t_F = 0.5 \mu\text{s}$ ,  $V_{IN} = 3.5 \text{ V}$**

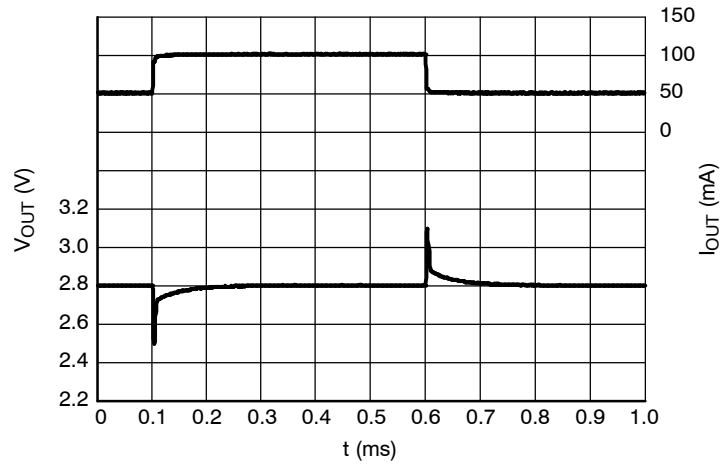

**Figure 45. Load Transients, 2.8 V Version,  
 $I_{OUT} = 50 - 100 \text{ mA}$ ,  $t_R = t_F = 0.5 \mu\text{s}$ ,  $V_{IN} = 3.8 \text{ V}$**

# NCP4682, NCP4685

## TYPICAL CHARACTERISTICS

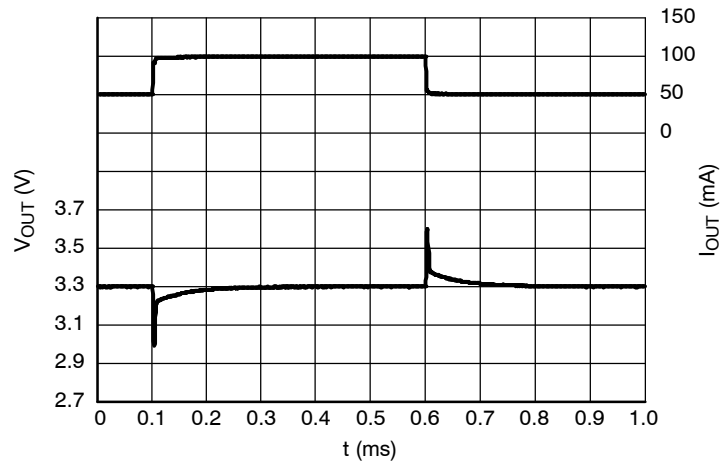

**Figure 46. Load Transients, 3.3 V Version,  
 $I_{OUT} = 50 - 100$  mA,  $t_R = t_F = 0.5$   $\mu$ s,  $V_{IN} = 4.3$  V**

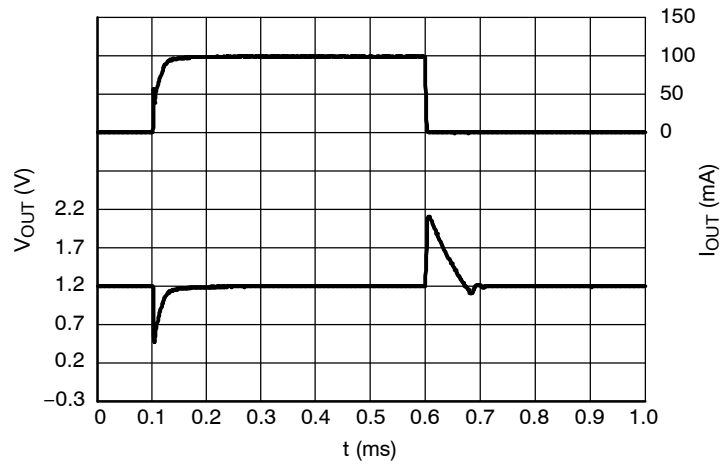

**Figure 47. Load transients, 1.2 V Version,  
 $I_{OUT} = 1 - 100$  mA,  $t_R = t_F = 0.5$   $\mu$ s,  $V_{IN} = 2.2$  V**

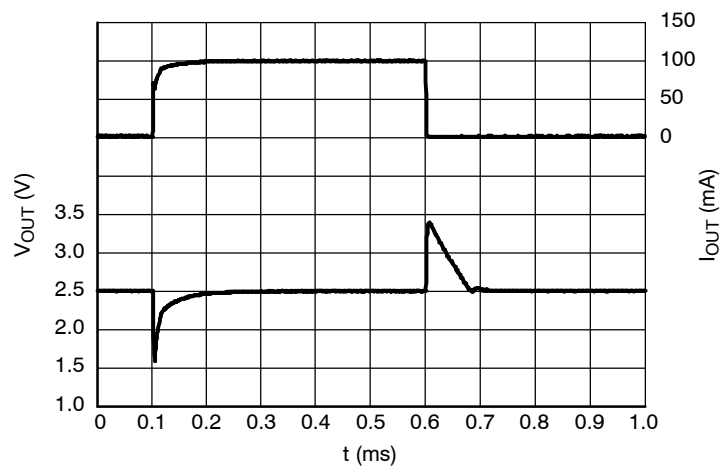

**Figure 48. Load Transients, 2.5 V Version,  
 $I_{OUT} = 1 - 100$  mA,  $t_R = t_F = 0.5$   $\mu$ s,  $V_{IN} = 3.5$  V**

# NCP4682, NCP4685

## TYPICAL CHARACTERISTICS

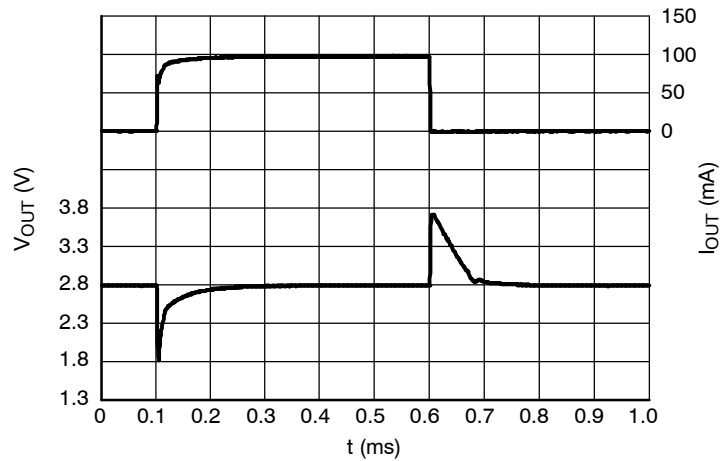

**Figure 49. Load Transients, 2.8 V Version,  
 $I_{OUT} = 1 - 100 \text{ mA}$ ,  $t_R = t_F = 0.5 \mu\text{s}$ ,  $V_{IN} = 3.8 \text{ V}$**

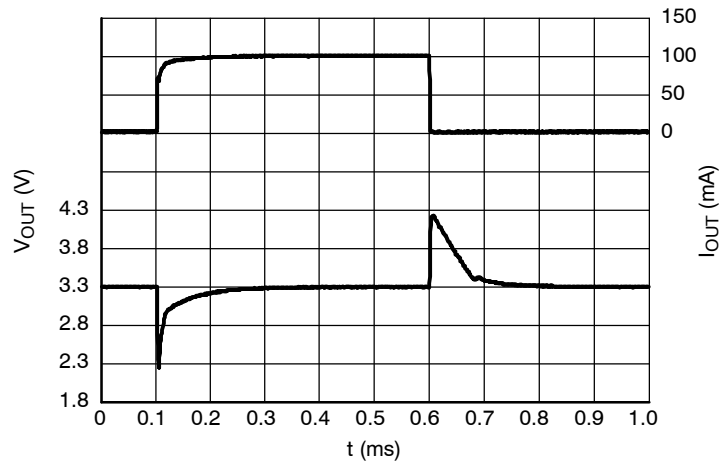

**Figure 50. Load Transients, 3.3 V Version,  
 $I_{OUT} = 1 - 100 \text{ mA}$ ,  $t_R = t_F = 0.5 \mu\text{s}$ ,  $V_{IN} = 4.3 \text{ V}$**

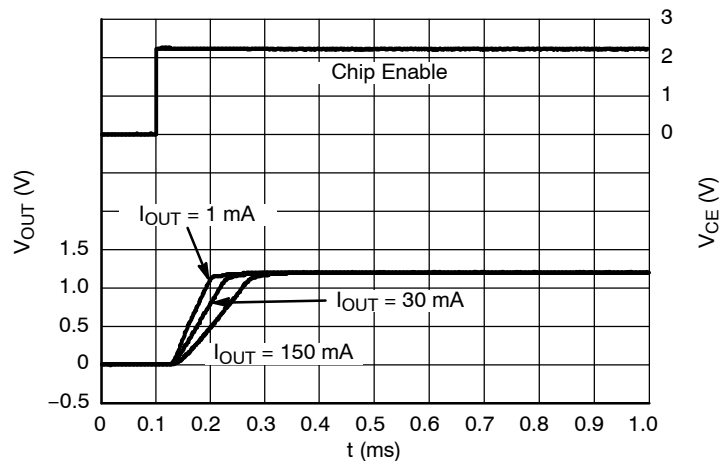

**Figure 51. Start-up, NCP4682 1.2 V Version,  
 $V_{IN} = 2.2 \text{ V}$**

# NCP4682, NCP4685

## TYPICAL CHARACTERISTICS

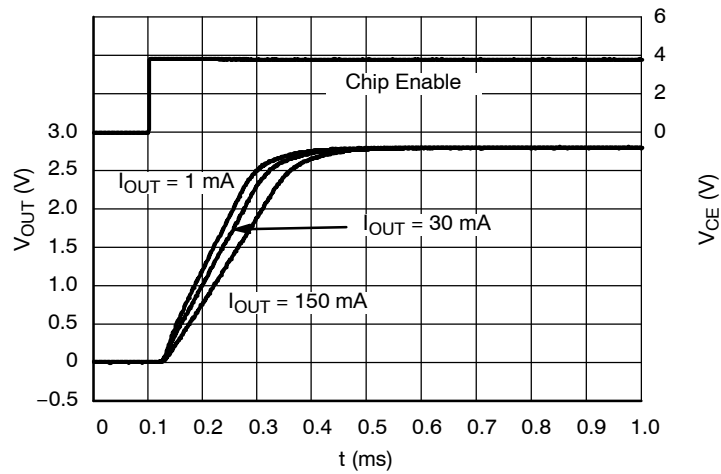

Figure 52. Start-up, NCP4682 2.8 V Version,  
 $V_{IN} = 3.8$  V

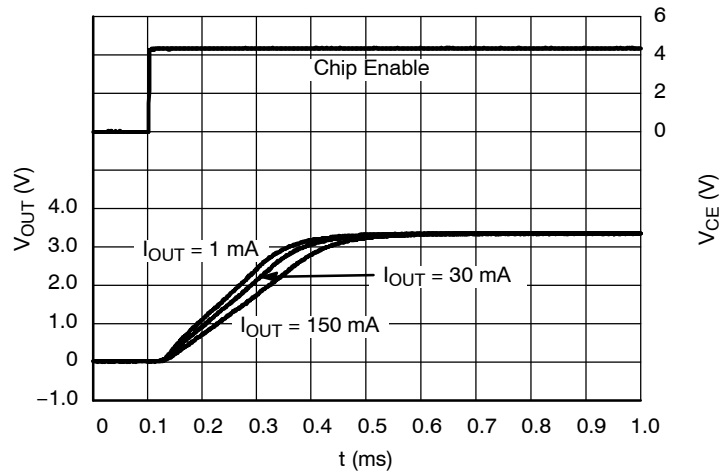

Figure 53. Start-up, NCP4682 3.3 V Version,  
 $V_{IN} = 4.3$  V

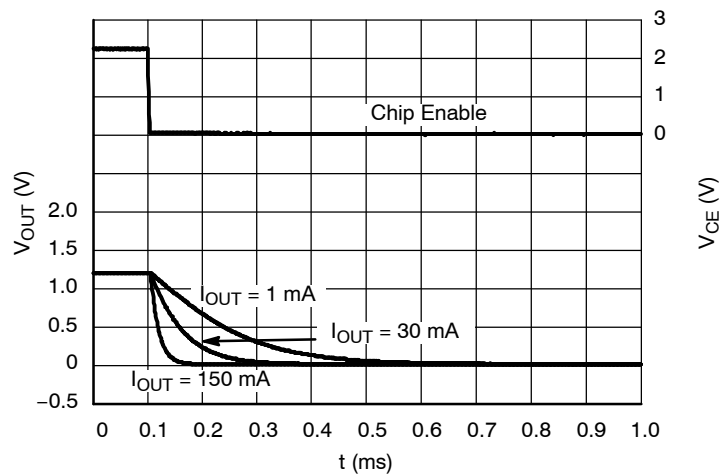
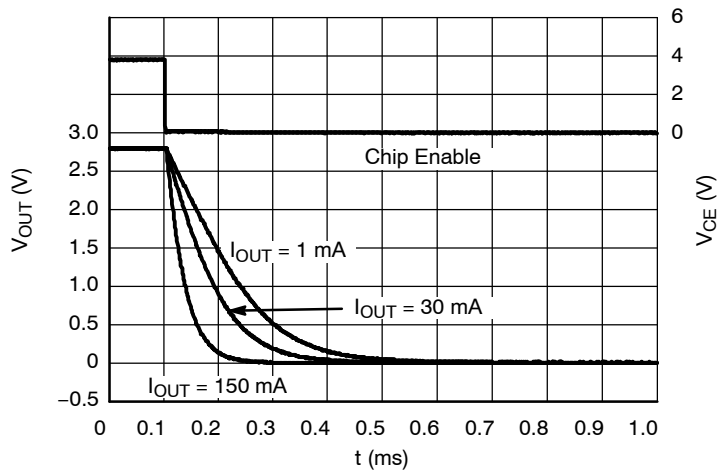
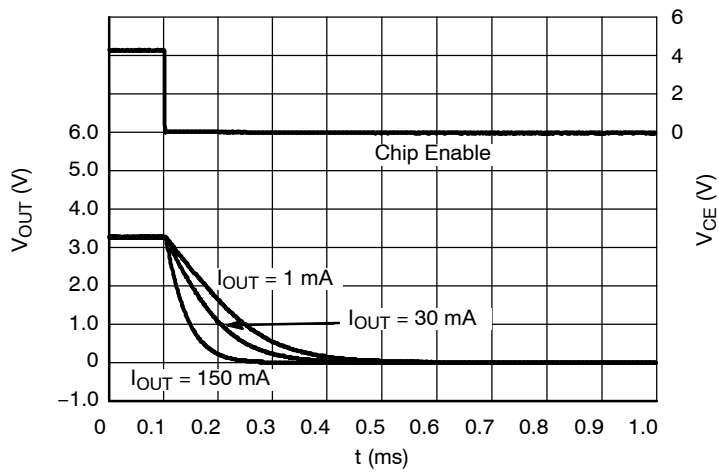

Figure 54. Shutdown, NCP4682 1.2 V Version D,  
 $V_{IN} = 2.2$  V

# NCP4682, NCP4685



**Figure 55. Shutdown, NCP4682 2.8 V Version D,  
 $V_{IN} = 3.8\text{ V}$**



**Figure 56. Shutdown, NCP4682 3.3 V Version D,  
 $V_{IN} = 4.3\text{ V}$**

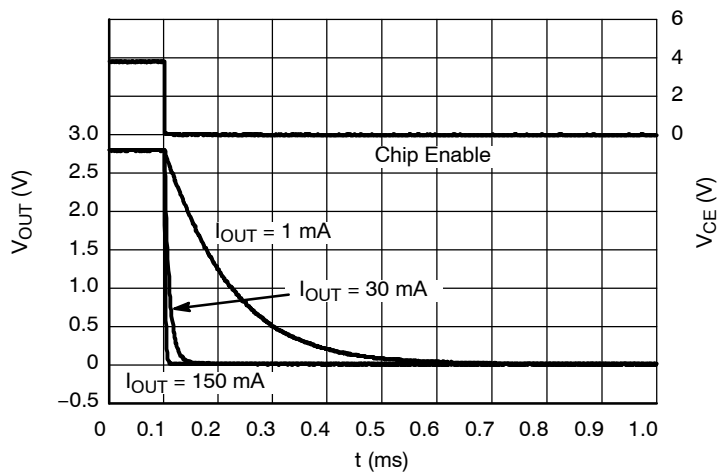

**Figure 57. Shutdown, NCP4682 2.8 V Version H,  
 $V_{IN} = 3.8\text{ V}$**

APPLICATION INFORMATION

A typical application circuits for NCP4682 and NCP4685 series is shown in Figure 58.

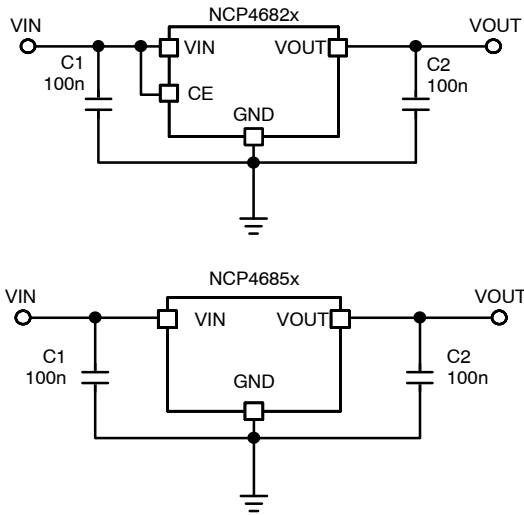

Figure 58. Typical Application Schematic

**Input Decoupling Capacitor (C1)**

A 0.1  $\mu$ F ceramic input decoupling capacitor should be connected as close as possible to the input and ground pin of the NCP4682/5. Higher values and lower ESR improves line transient response.

**Output Decoupling Capacitor (C2)**

A 0.1  $\mu$ F ceramic output decoupling capacitor is enough to achieve stable operation of the IC. If a tantalum capacitor is used, and its ESR is high, loop oscillation may result. The capacitors should be connected as close as possible to the output and ground pins. Larger values and lower ESR improves dynamic parameters.

**Current Limit**

This regulator includes a fold-back current limiting circuit. This type of protection doesn't limit output current

up to specified current capability in normal operation, but when an over current situation occurs, the output voltage and current decrease until the over current condition ends. Typical characteristics of this protection scheme are shown in the Output voltage versus Output current graphs in the characterization section of this datasheet.

**Enable Operation (NCP4682 Only)**

The enable pin CE may be used for turning the regulator on and off. The IC is switched on when a high level voltage is applied to the CE pin. The enable pin has an internal pull down current source. If the enable function is not needed, connect CE pin to VIN.

**Output Discharger (NCP4682 Only)**

The NCP4682D version includes a transistor between VOUT and GND that is used for faster discharging of the output capacitor. This function is activated when the IC goes into disable mode.

**Thermals**

As a power across the IC increase, it might become necessary to provide some thermal relief. The maximum power dissipation supported by the device is dependent upon board design and layout. Mounting pad configuration on the PCB, the board material, and also the ambient temperature affect the rate of temperature increase for the part. When the device has good thermal conductivity through the PCB the junction temperature will be relatively low in high power dissipation applications.

**PCB layout**

Make the VIN and GND line as large as practical. If their impedance is high, noise pickup or unstable operation may result. Connect capacitors C1 and C2 as close as possible to the IC, and make wiring as short as possible.

## NCP4682, NCP4685

### ORDERING INFORMATION

Device	Nominal Output Voltage	Description	Marking	Package	Shipping
NCP4682DMU12TCG	1.2 V	Auto discharge	CA	UDFN4 (Pb-Free)	10000 / Tape & Reel
NCP4682DMU15TCG	1.5 V	Auto discharge	CC		
NCP4682DMU18TCG	1.8 V	Auto discharge	CD		
NCP4682DMU19TCG	1.9 V	Auto discharge	CF		
NCP4682DMU25TCG	2.5 V	Auto discharge	CH		
NCP4682DMU28TCG	2.8 V	Auto discharge	CL		
NCP4682DMU30TCG	3.0 V	Auto discharge	CP		
NCP4682DMU33TCG	3.3 V	Auto discharge	CR		
NCP4682HMU18TCG	1.8 V	Enable high	AD		
NCP4682HMU28TCG	2.8 V	Enable high	AL		
NCP4682HMU33TCG	3.3 V	Enable high	AR		
NCP4685EMU30TCG	3.0 V	Without enable	BP		
NCP4682DSN30T1G	3.0 V	Auto discharge	92P	SOT-23-5 (Pb-Free)	3000 / Tape & Reel
NCP4682DSN33T1G	3.3 V	Auto discharge	92R		
NCP4682DSQ12T1G	1.2 V	Auto discharge	R0	SC-82AB (Pb-Free)	3000 / Tape & Reel
NCP4682DSQ15T1G	1.5 V	Auto discharge	R2		
NCP4682DSQ18T1G	1.8 V	Auto discharge	R3		
NCP4682DSQ20T1G	2.0 V	Auto discharge	R6		
NCP4682DSQ25T1G	2.5 V	Auto discharge	R7		
NCP4682DSQ28T1G	2.8 V	Auto discharge	S0		
NCP4682DSQ33T1G	3.3 V	Auto discharge	S5		
NCP4685ESQ15T1G	1.5 V	Without enable	N2		
NCP4685ESQ25T1G	2.5 V	Without enable	N7		
NCP4685ESQ33T1G	3.3 V	Without enable	P5		

†For information on tape and reel specifications, including part orientation and tape sizes, please refer to our Tape and Reel Packaging Specifications Brochure, BRD8011/D.

\*To order other package and voltage variants, please contact your ON Semiconductor sales representative.

# NCP4682, NCP4685

## PACKAGE DIMENSIONS

### SOT-23 5-LEAD CASE 1212 ISSUE A

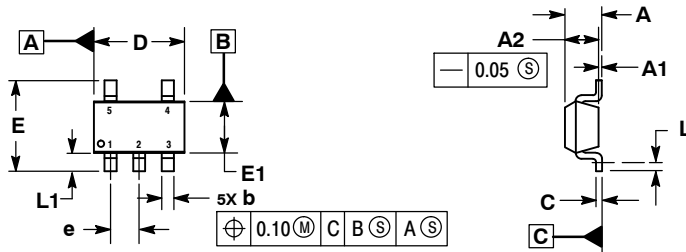

NOTES:

1. DIMENSIONING AND TOLERANCING PER ASME Y14.5M, 1994.
2. CONTROLLING DIMENSIONS: MILLIMETERS.
3. DATUM C IS THE SEATING PLANE.

MILLIMETERS		
DIM	MIN	MAX
A	---	1.45
A1	0.00	0.10
A2	1.00	1.30
b	0.30	0.50
c	0.10	0.25
D	2.70	3.10
E	2.50	3.10
E1	1.50	1.80
e	0.95 BSC	
L	0.20	---
L1	0.45	0.75

### RECOMMENDED SOLDERING FOOTPRINT\*

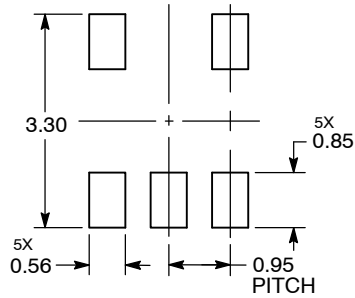

DIMENSIONS: MILLIMETERS

\*For additional information on our Pb-Free strategy and soldering details, please download the ON Semiconductor Soldering and Mounting Techniques Reference Manual, SOLDERRM/D.

# NCP4682, NCP4685

## PACKAGE DIMENSIONS

**SC-82AB**  
CASE 419C-02  
ISSUE E

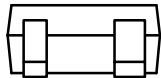
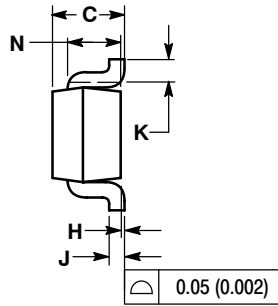
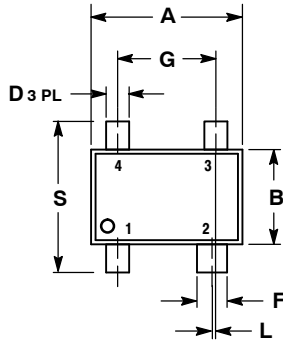

**NOTES:**

1. DIMENSIONING AND TOLERANCING PER ANSI Y14.5M, 1982.
2. CONTROLLING DIMENSION: MILLIMETER.
3. 419C-01 OBSOLETE. NEW STANDARD IS 419C-02.
4. DIMENSIONS A AND B DO NOT INCLUDE MOLD FLASH, PROTRUSIONS, OR GATE BURRS.

DIM	MILLIMETERS		INCHES	
	MIN	MAX	MIN	MAX
A	1.8	2.2	0.071	0.087
B	1.15	1.35	0.045	0.053
C	0.8	1.1	0.031	0.043
D	0.2	0.4	0.008	0.016
F	0.3	0.5	0.012	0.020
G	1.1	1.5	0.043	0.059
H	0.0	0.1	0.000	0.004
J	0.10	0.26	0.004	0.010
K	0.1	---	0.004	---
L	0.05 BSC		0.002 BSC	
N	0.2 REF		0.008 REF	
S	1.8	2.4	0.07	0.09

### SOLDERING FOOTPRINT\*

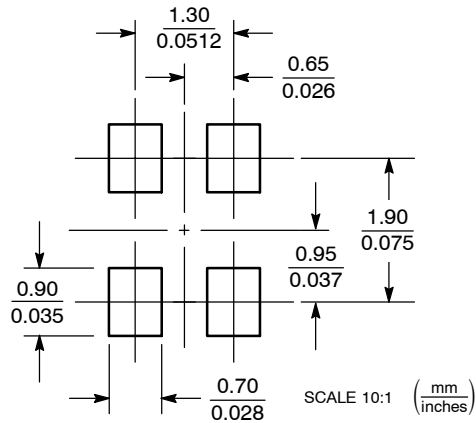

\*For additional information on our Pb-Free strategy and soldering details, please download the ON Semiconductor Soldering and Mounting Techniques Reference Manual, SOLDERRM/D.

# NCP4682, NCP4685

## PACKAGE DIMENSIONS

### UDFN4 1.0x1.0, 0.65P CASE 517BR ISSUE O

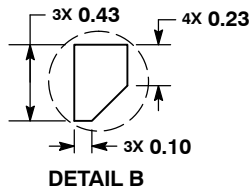
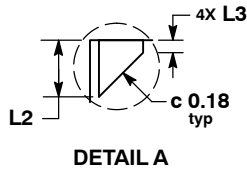
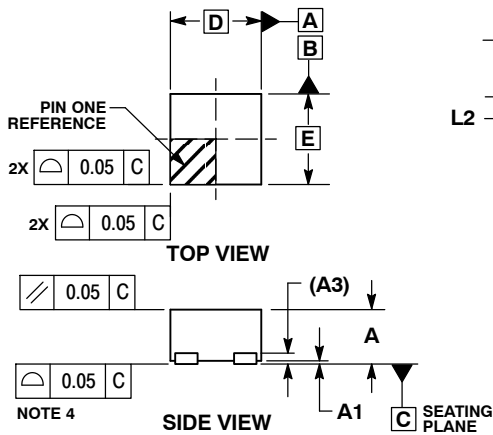

**NOTES:**

1. DIMENSIONING AND TOLERANCING PER ASME Y14.5M, 1994.
2. CONTROLLING DIMENSION: MILLIMETERS.
3. DIMENSION b APPLIES TO PLATED TERMINAL AND IS MEASURED BETWEEN 0.15 AND 0.20 mm FROM TERMINAL.
4. COPLANARITY APPLIES TO THE EXPOSED PAD AS WELL AS THE TERMINALS.

DIM	MILLIMETERS	
	MIN	MAX
A	---	0.60
A1	0.00	0.05
A3	0.10	REF
b	0.20	0.30
D	1.00	BSC
D2	0.43	0.53
E	1.00	BSC
e	0.65	BSC
L	0.20	0.30
L2	0.27	0.37
L3	0.02	0.12

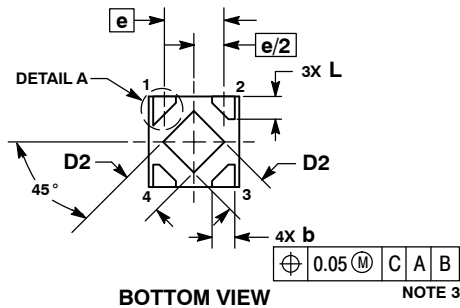

### RECOMMENDED MOUNTING FOOTPRINT\*

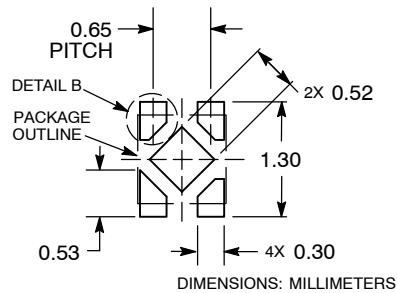

\*For additional information on our Pb-Free strategy and soldering details, please download the ON Semiconductor Soldering and Mounting Techniques Reference Manual, SOLDERRM/D.

ON Semiconductor and are registered trademarks of Semiconductor Components Industries, LLC (SCILLC). SCILLC reserves the right to make changes without further notice to any products herein. SCILLC makes no warranty, representation or guarantee regarding the suitability of its products for any particular purpose, nor does SCILLC assume any liability arising out of the application or use of any product or circuit, and specifically disclaims any and all liability, including without limitation special, consequential or incidental damages. "Typical" parameters which may be provided in SCILLC data sheets and/or specifications can and do vary in different applications and actual performance may vary over time. All operating parameters, including "Typicals" must be validated for each customer application by customer's technical experts. SCILLC does not convey any license under its patent rights nor the rights of others. SCILLC products are not designed, intended, or authorized for use as components in systems intended for surgical implant into the body, or other applications intended to support or sustain life, or for any other application in which the failure of the SCILLC product could create a situation where personal injury or death may occur. Should Buyer purchase or use SCILLC products for any such unintended or unauthorized application, Buyer shall indemnify and hold SCILLC and its officers, employees, subsidiaries, affiliates, and distributors harmless against all claims, costs, damages, and expenses, and reasonable attorney fees arising out of, directly or indirectly, any claim of personal injury or death associated with such unintended or unauthorized use, even if such claim alleges that SCILLC was negligent regarding the design or manufacture of the part. SCILLC is an Equal Opportunity/Affirmative Action Employer. This literature is subject to all applicable copyright laws and is not for resale in any manner.

### PUBLICATION ORDERING INFORMATION

**LITERATURE FULFILLMENT:**  
Literature Distribution Center for ON Semiconductor  
P.O. Box 5163, Denver, Colorado 80217 USA  
**Phone:** 303-675-2175 or 800-344-3860 Toll Free USA/Canada  
**Fax:** 303-675-2176 or 800-344-3867 Toll Free USA/Canada  
**Email:** orderlit@onsemi.com

**N. American Technical Support:** 800-282-9855 Toll Free  
USA/Canada  
**Europe, Middle East and Africa Technical Support:**  
Phone: 421 33 790 2910  
**Japan Customer Focus Center**  
Phone: 81-3-5817-1050

**ON Semiconductor Website:** [www.onsemi.com](http://www.onsemi.com)  
**Order Literature:** <http://www.onsemi.com/orderlit>

For additional information, please contact your local Sales Representative

## Looking for pricing, stock, or lifecycle information?

Click below to explore more details on WIN SOURCE:

 [View NCP4682DSQ25T1G on WIN SOURCE](#)

 [ON Semiconductor](#) Information

## Optimize Your Supply Chain with WIN SOURCE Solutions

-  Global Sourcing Solution
-  Obsolete Management
-  Cost Control Management
-  Shortage Management
-  Alternative Solution
-  Excess Inventory Management