



**THE DATASHEET OF  
ISL9122AIRNZ-T**



# ISL9122A

Ultra-Low I<sub>Q</sub> Buck-Boost Regulator With Bypass

The ISL9122A is a highly integrated non-inverting buck-boost switching regulator that accepts input voltages both above or below the regulated output voltage. It features an extremely low quiescent current consumption of 1300nA in Regulation mode, 120nA in Forced Bypass mode, and 8nA in Shutdown mode. It supports input voltages from 1.8V to 5.5V.

The ISL9122A has automatic bypass functionality for situations in which the input voltage is close to the output voltage, and it automatically transitions between Buck and Boost modes without significant output disturbance. In addition to the automatic bypass functionality, the Forced Bypass power saving mode can be chosen if voltage regulation is not required. Forced Bypass power saving mode is accessible using the I<sup>2</sup>C interface bus.

The ISL9122A is capable of delivering up to 500mA of output current ( $V_{IN} > V_{OUT} > 2.5V$ ) and provides excellent efficiency because of its adaptive frequency hysteretic control architecture.

The ISL9122A is designed for stand-alone applications and supports a default output voltage at Power-On Reset (POR). After POR, the output voltage can be adjusted in the range of 1.8V to 5.375V by using the I<sup>2</sup>C interface bus. Specific default output voltages are available upon request.

The ISL9122A requires only a single EIA 0603 size inductor and a minimum of two external capacitors. Power supply solution size is minimized by a 1.8mm×1.0mm 8 Bump WLCSP and it is also available in a 3.0mm×2.0mm 8 Ld plastic DFN.

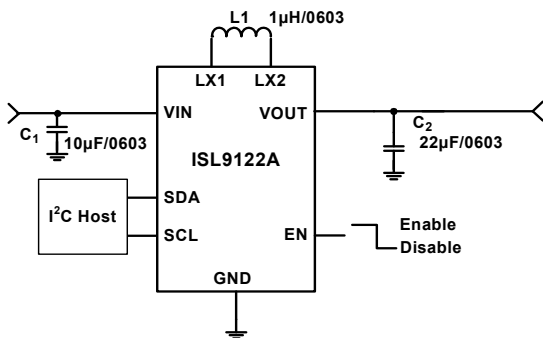

Figure 1. Typical Application (Minimum De-rated  
C<sub>2</sub> = 6µF)

## Features

- 1300nA quiescent current
- 84% efficiency at 10µA load ( $V_{IN} = 3.6V$ ,  $V_{OUT} = 3.3V$ )
- 97% peak efficiency ( $V_{IN} = 3.6V$ ,  $V_{OUT} = 3.3V$ )
- Input voltage range: 1.8V to 5.5V
- Output voltage range: 1.8V to 5.375V
- Output current: up to 500mA ( $V_{IN} > V_{OUT} > 2.5V$ )
- Selectable Forced and Auto Bypass power saving modes
- Seamless PWM/PFM and buck/boost transition
- I<sup>2</sup>C control and voltage adjustability
- Hysteretic controller
- Small 1.8mm×1.0mm 8 Bump WLCSP and 3.0mm×2.0mm 8 Ld DFN packages

## Applications

- Smart watches and wristband devices
- Wireless earphones
- Internet of Things (IoT) devices
- Water, gas, and oil meters
- Portable medical devices
- Hearing aid devices

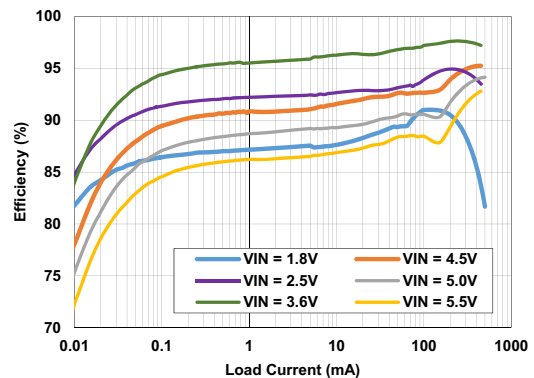

Figure 2. Efficiency vs Load Current: V<sub>OUT</sub> = 3.3V,  
T<sub>A</sub> = +25°C

## Contents

<b>1. Overview</b>	<b>3</b>
1.1 Block Diagram	3
<b>2. Pin Information</b>	<b>4</b>
2.1 Pin Assignments	4
2.2 Pin Descriptions	4
<b>3. Specifications</b>	<b>5</b>
3.1 Absolute Maximum Ratings	5
3.2 Recommended Operating Conditions	5
3.3 Thermal Specifications	5
3.4 Analog Specifications	6
3.5 I <sup>2</sup> C Interface Timing Specifications	8
<b>4. Typical Performance Graphs</b>	<b>9</b>
4.1 Line/Load Transient Waveforms	14
<b>5. Functional Description</b>	<b>18</b>
5.1 Enable Input	18
5.2 Soft Discharge	18
5.3 Startup	18
5.4 Overcurrent/Short-Circuit Protection	18
5.5 Thermal Shutdown	18
5.6 Buck-Boost Conversion Topology	19
5.7 Pulse Width Modulation (PWM) Operation	19
5.8 Pulse Frequency Modulation (PFM) Operation	19
5.9 Operation With $V_{IN}$ Close to $V_{OUT}$	20
5.10 Forced Operating Modes	20
5.11 I <sup>2</sup> C Serial Interface	20
5.11.1 Protocol Conventions	21
5.11.2 Write Operation	22
5.11.3 Read Operation	22
<b>6. Register Descriptions</b>	<b>23</b>
6.1 RO_REG1	23
6.2 INTFLG_REG	24
6.3 VSET	24
6.4 CONV_CFG	25
6.5 INTFLG_MASK	25
<b>7. Package Outline Drawings</b>	<b>26</b>
<b>8. Ordering Information</b>	<b>28</b>
<b>9. Revision History</b>	<b>29</b>

# 1. Overview

## 1.1 Block Diagram

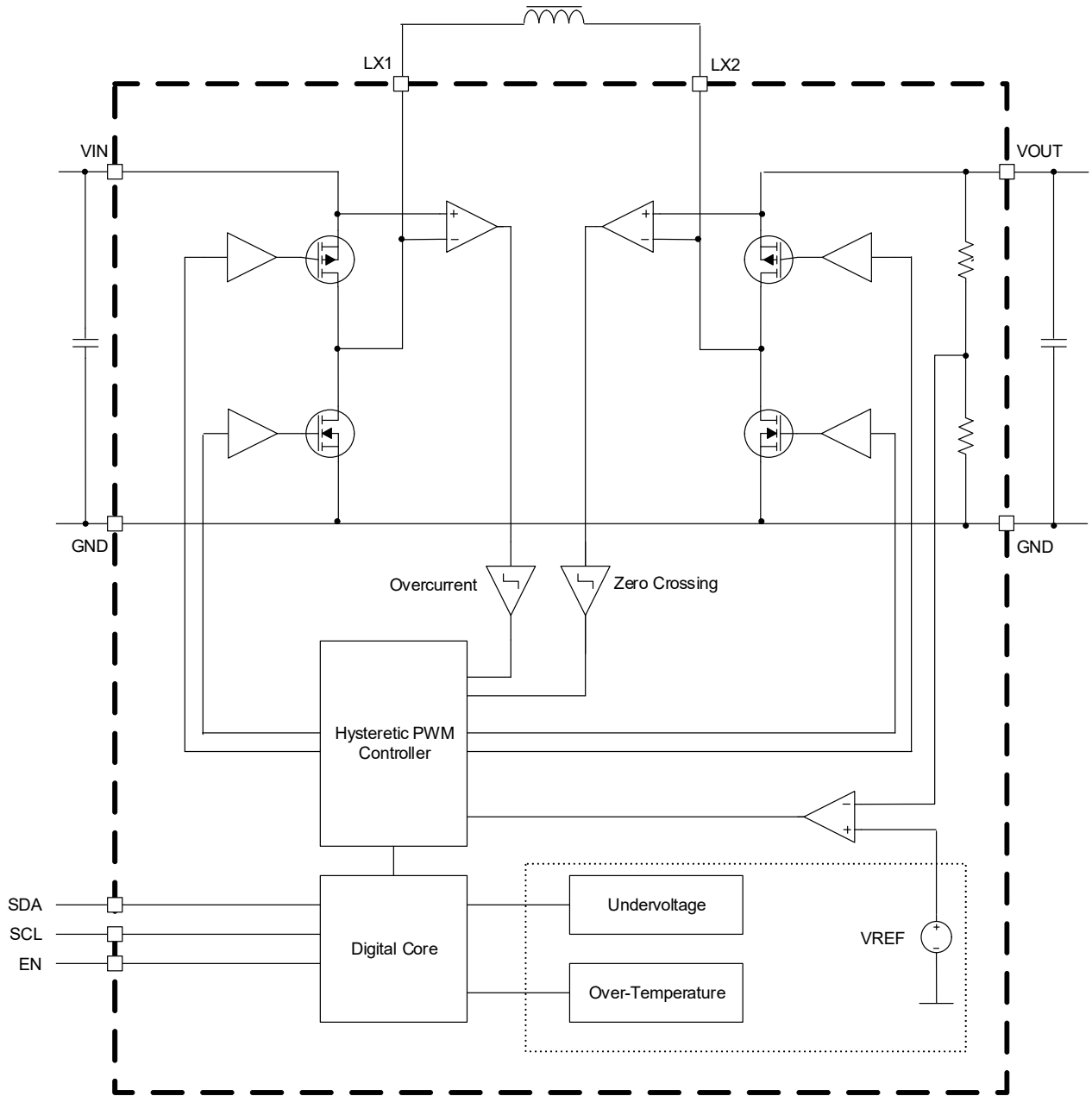
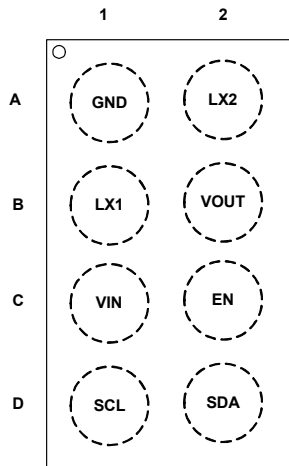

Figure 3. Block Diagram

## 2. Pin Information

### 2.1 Pin Assignments



8 Bump WLCSP - Top View

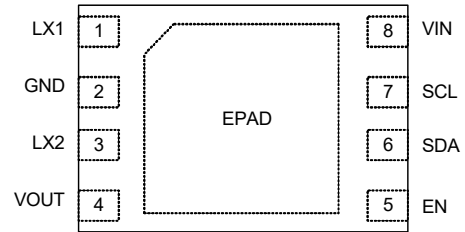

8 Ld DFN - Top View

### 2.2 Pin Descriptions

WLCSP Pin #	DFN Pin #	Pin Names	Description
B2	4	VOUT	Buck-boost output
A2	3	LX2	Inductor connection, output side
A1	2	GND	Ground connection
B1	1	LX1	Inductor connection, input side
C1	8	VIN	Power supply input
C2	5	EN	Logic input, drive HIGH to enable device. Do not leave floating.
D2	6	SDA	I <sup>2</sup> C data input. Pull down to GND if not being used. Do not leave floating.
D1	7	SCL	I <sup>2</sup> C clock input. Pull down to GND if not being used. Do not leave floating.
N/A	9	EPAD	Exposed Pad. Must be soldered to PCB GND.

### 3. Specifications

#### 3.1 Absolute Maximum Ratings

**Caution:** Do not operate at or near the maximum ratings listed for extended periods of time. Exposure to such conditions can adversely impact product reliability and result in failures not covered by warranty.

Parameter	Minimum	Maximum	Unit
VIN, VOUT	-0.3	6.5	V
LX1, LX2	-0.3	6.5	V
LX1, LX2 (less than 10ns)	-2.0	8.0	V
All Other Pins	-0.3	6.5	V
Maximum Junction Temperature	-	+125	°C
Maximum Storage Temperature Range	-65	+150	°C
Human Body Model (Tested per JS-001-2017)	-	2	kV
Charged Device Model (Tested per JS-002-2018)	-	1	kV
Latch-Up (Tested per JESD78E; Class 2, Level A)	-	100	mA

#### 3.2 Recommended Operating Conditions

Parameter	Minimum	Maximum	Unit
Ambient Temperature (T <sub>A</sub> ) Range	-40	+85	°C
Supply Voltage (V <sub>IN</sub> ) Range	1.8	5.5	V
Output Voltage (V <sub>OUT</sub> ) Range	1.8	5.375	V
Load Current (I <sub>OUT</sub> ) Range (DC)	0	See <a href="#">Figure 16</a>	mA
Effective Output Capacitance (C <sub>OUT</sub> ) <sup>[1]</sup>	6	-	μF
Effective Input Capacitance (C <sub>IN</sub> ) <sup>[1]</sup>	5	-	μF

1. Refer to *ISL9122A Evaluation Board Manual* for the reference design and recommended components.

#### 3.3 Thermal Specifications

Parameter	Package	Symbol	Conditions	Typical Value	Unit
Thermal Resistance	8 Bump WLCSP Package	$\theta_{JA}$ <sup>[1]</sup>	Junction to ambient	110	°C/W
		$\theta_{JB}$ <sup>[2]</sup>	Junction to board	28	°C/W
Thermal Resistance	8 Ld 2x3 DFN Package	$\theta_{JA}$ <sup>[1]</sup>	Junction to ambient	72	°C/W
		$\theta_{JC}$ <sup>[3]</sup>	Junction to case	21	°C/W

1.  $\theta_{JA}$  is measured in free air with the component mounted on a high-effective thermal conductivity test board with direct attach features. See [TB379](#) for details.

2. For  $\theta_{JB}$ , the board temperature is taken on the board near the edge of the package, on a copper trace at the center of one side.

3. For  $\theta_{JC}$ , the case temperature location is the center of the exposed metal pad on the package underside. See [TB379](#).

### 3.4 Analog Specifications

$V_{IN} = V_{EN} = 3.6V$ ,  $V_{OUT} = 3.3V$ , I<sup>2</sup>C pull-up voltage = 3.6V,  $L_1 = 1\mu H$ ,  $C_1 = 10\mu F$ ,  $C_2 = C_{OUT}$  (Effective) = 6 $\mu F$ ,  $T_A = +25^\circ C$ . **Boldface limits apply across the recommended operating temperature range (-40°C to +85°C) and input voltage range (1.8V to 5.5V), unless specified otherwise.**

Parameter	Symbol	Test Conditions	Min <sup>[1]</sup>	Typ	Max <sup>[1]</sup>	Unit
<b>Power Supply</b>						
Input Voltage Range	$V_{IN}$	-	<b>1.8</b>	-	<b>5.5</b>	V
$V_{IN}$ Undervoltage Lockout Threshold	$V_{UVLO}$	$V_{IN}$ Rising	-	-	<b>1.79</b>	V
$V_{UVLO}$ Hysteresis	$HYST_{UVLO}$	-	-	40	-	mV
$V_{IN}$ Quiescent Current <sup>[2]</sup>	$I_Q$	$V_{IN} = 3.6V$ , $I_{OUT} = 0A$	-	1300	<b>1800</b>	nA
$V_{IN}$ Supply Current, Shutdown	$I_{SD}$	$V_{IN} = 3.6V$ , $V_{EN}$ pulled to GND	-	8	<b>450</b>	nA
$V_{IN}$ Supply Current, Soft Shutdown	$I_{SSD}$	$V_{IN} = 3.6V$ , Shutdown using I <sup>2</sup> C register. $EN\_AND = CONV\_CFG[7] = 0$	-	40	<b>450</b>	nA
$V_{IN}$ Supply Current, Forced Bypass Mode	$I_{BYP}$	$V_{IN} = 3.6V$ , $I_{OUT} = 0A$ . Forced Bypass using I <sup>2</sup> C register. $FMODE = CONV\_CFG[3:2] = 0x3$	-	120	<b>850</b>	nA
<b>Output Voltage Regulation</b>						
Output Voltage Range	$V_{OUT}$	$1.8V < V_{IN} < 5.5V$ , $I_{OUT} = 1mA$	<b>1.8</b>	-	<b>5.375</b>	V
<b>Output Voltage Accuracy</b>						
ISL9122AIINZ, ISL9122AIRNZ	$V_{OUT\_ACC}$	$V_{IN} = 3.6V$ , $V_{OUT} = 3.3V$ , $I_{OUT} = 0A$ , forced PWM	-2.5	-	+2.5	%
		$V_{IN} = 3.6V$ , $V_{OUT} = 3.3V$ , $I_{OUT} = 1mA$ , PFM	-3.6	-	+3.6	%
<b>Soft-Start and Soft Discharge</b>						
Time to Read OTP	$t_{OTP}$	Time from when $V_{IN} > V_{UVLO}$ and EN signal asserts until switching starts	-	125	-	$\mu s$
$V_{OUT}$ Ramp Rate for Soft Start and During Dynamic Voltage Scaling (applicable only for $V_{OUT}$ ramp-up, not ramp-down)	DVSRATE	Default at POR	-	3.125	-	mV/ $\mu s$
		Programmable using I <sup>2</sup> C after POR	-	6.25 0.78125 1.5625	-	mV/ $\mu s$
$V_{OUT}$ Soft Discharge ON-Resistance	$r_{DISCHG}$	$V_{EN}$ pulled to GND	-	160	-	$\Omega$
<b>Power MOSFET (WLCSP Package)</b>						
P-Channel MOSFET ON-Resistance (Buck)	$r_{DSON\_A}$	$V_{IN} = 3.6V$ , $V_{OUT} = 3.6V$	-	52	-	m $\Omega$
N-Channel MOSFET ON-Resistance (Buck)	$r_{DSON\_B}$		-	50	-	m $\Omega$
P-Channel MOSFET ON-Resistance (Boost)	$r_{DSON\_D}$		-	55	-	m $\Omega$
N-Channel MOSFET ON-Resistance (Boost)	$r_{DSON\_C}$		-	51	-	m $\Omega$

$V_{IN} = V_{EN} = 3.6V$ ,  $V_{OUT} = 3.3V$ , I<sup>2</sup>C pull-up voltage = 3.6V,  $L_1 = 1\mu H$ ,  $C_1 = 10\mu F$ ,  $C_2 = C_{OUT}$  (Effective) = 6 $\mu F$ ,  $T_A = +25^\circ C$ . **Boldface limits apply across the recommended operating temperature range (-40°C to +85°C) and input voltage range (1.8V to 5.5V), unless specified otherwise.** (Cont.)

Parameter	Symbol	Test Conditions	Min <sup>[1]</sup>	Typ	Max <sup>[1]</sup>	Unit
<b>Power MOSFET (DFN Package)</b>						
P-Channel MOSFET ON-Resistance (Buck)	$r_{DS(ON)_A}$	$V_{IN} = 3.6V, V_{OUT} = 3.6V$	-	52	-	m $\Omega$
N-Channel MOSFET ON-Resistance (Buck)	$r_{DS(ON)_B}$		-	51	-	m $\Omega$
P-Channel MOSFET ON-Resistance (Boost)	$r_{DS(ON)_D}$		-	54	-	m $\Omega$
N-Channel MOSFET ON-Resistance (Boost)	$r_{DS(ON)_C}$		-	51	-	m $\Omega$
<b>Bypass Mode</b>						
Auto Bypass Thresholds	$V_{IN\_BYP}$	Auto bypass thresholds - input voltage range. $I_{OUT} = 10mA$	-	$\pm 1\% \times V_{OUT}$	-	V
<b>Inductor Peak Current Limit</b>						
Peak Current Limit	$I_{LIM}$	$2.5V < V_{IN} < 5.5V$	-	2.5	-	A
		$1.8V < V_{IN} < 2.5V$	-	$2.5 \times (V_{IN}/2.5)$	-	A
<b>Efficiency</b>						
Efficiency	$\eta$	$I_{OUT} = 50mA, V_{IN} = 3.7V, V_{OUT} = 3.3V$	-	97	-	%
		$I_{OUT} = 10\mu A, V_{IN} = 3.7V, V_{OUT} = 3.3V$	-	84	-	%
<b>Switching Frequency</b>						
Switching Frequency	$f_{SW}$	$V_{IN} = 3.6V, V_{OUT} = 1.8V, I_{OUT} = 1mA$ , Forced PWM	-	2.5	-	MHz
<b>Hiccup Mode</b>						
Hiccup Time	$t_{FLT\_WAIT}$	Time from OCP shutdown to restart	-	100	-	ms
<b>Thermal Protection</b>						
Thermal Shutdown Threshold	$T_{SD}$	Rising Temperature	-	130	-	$^\circ C$
Thermal Shutdown Hysteresis	$T_{SD\_HYS}$	-	-	25	-	$^\circ C$
<b>Logic Levels</b>						
Input Leakage	$I_{LEAK}$	EN pin	-	9	<b>300</b>	nA
		SCL pin	-	8	<b>300</b>	nA
		SDA pin	-	8	<b>300</b>	nA
EN Input HIGH Voltage	$EN_{IH}$	$V_{IN} = 3.6V$	<b>1.6</b>	-	-	V
EN Input LOW Voltage	$EN_{IL}$		-	-	<b>0.36</b>	V
SCL/SDA Input HIGH Voltage	$SCL/SDA_{IH}$		<b>1.45</b>	-	-	V
SCL/SDA Input LOW Voltage	$SCL/SDA_{IL}$		-	-	<b>0.36</b>	V

1. Parameters with MIN and/or MAX limits are 100% tested at +25°C, unless otherwise specified. Temperature limits established by characterization and are not production tested.

2. Quiescent current measurements are taken when the device is not switching.

### 3.5 I<sup>2</sup>C Interface Timing Specifications

Applicable to SCL and SDA in the Fast mode I<sup>2</sup>C operation, unless otherwise specified.

Parameter	Symbol	Test Conditions	Min <sup>[1]</sup>	Typ	Max <sup>[1]</sup>	Unit
I <sup>2</sup> C Frequency Capability	f <sub>I2C</sub>	-	0	-	400	kHz
Pulse Width Suppression Time at SDA and SCL Inputs	t <sub>SP</sub>	Any pulse narrower than the maximum specification is suppressed	-	-	50	ns
Data Valid Time	t <sub>VD:DAT</sub>	Time from SCL falling edge crossing SCL <sub>IL</sub> to SDA exiting the SDA <sub>IL</sub> to SDA <sub>IH</sub> window	-	-	900	ns
Data Valid Acknowledge Time	t <sub>VD:ACK</sub>	Time from SCL falling edge crossing SCL <sub>IL</sub> to SDA exiting the SDA <sub>IL</sub> to SDA <sub>IH</sub> window, during acknowledgment	-	-	900	ns
Bus Free Time Between a STOP and START Condition	t <sub>BUF</sub>	Time from SDA crossing SDA <sub>IH</sub> at STOP to SDA crossing SDA <sub>IH</sub> at the following START	1300	-	-	ns
SCL Low Time	t <sub>LOW</sub>	Measured at the SCL <sub>IL</sub> crossing	1300	-	-	ns
SCL High Time	t <sub>HIGH</sub>	Measured at the SCL <sub>IH</sub> crossing	600	-	-	ns
START Condition Set-Up Time	t <sub>SU:STA</sub>	Time from SCL rising edge crossing SCL <sub>IH</sub> to SDA falling edge crossing SDA <sub>IH</sub>	600	-	-	ns
START Condition Hold Time	t <sub>HD:STA</sub>	Time from SDA falling edge crossing SDA <sub>IL</sub> to SCL falling edge crossing SCL <sub>IH</sub>	600	-	-	ns
Data Set-Up Time	t <sub>SU:DAT</sub>	Time from SDA exiting the SDA <sub>IL</sub> to SDA <sub>IH</sub> window to SCL rising edge crossing SCL <sub>IL</sub>	100	-	-	ns
Data Hold Time	t <sub>HD:DAT</sub>	Time from SCL falling edge crossing SCL <sub>IL</sub> to SDA entering the SDA <sub>IL</sub> to SDA <sub>IH</sub> window	50	-	-	ns
STOP Condition Set-Up Time	t <sub>SU:STO</sub>	Time from SCL rising edge crossing SCL <sub>IH</sub> to SDA rising edge crossing SDA <sub>IL</sub>	600			ns
SCL/SDA Capacitive Loading	C <sub>b</sub>	Capacitive load for each bus line			400	pF

1. Limits established by design and are not production tested.

### 4. Typical Performance Graphs

$V_{IN} = V_{EN} = 3.6V$ ,  $V_{OUT} = 3.3V$ , I<sup>2</sup>C pull-up voltage = 3.6V, L1 = 1 $\mu$ H/0603, C<sub>1</sub> = C<sub>IN</sub> = 10 $\mu$ F/0603, C<sub>2</sub> = C<sub>OUT</sub> = 22 $\mu$ F/0603, T<sub>A</sub> = +25°C, unless otherwise stated.

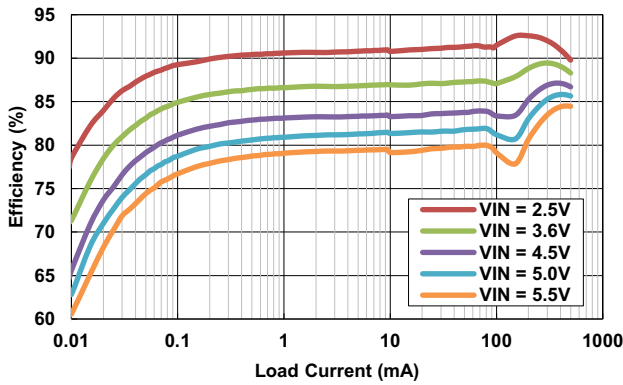

Figure 4. Efficiency vs Load Current:  $V_{OUT} = 1.8V$

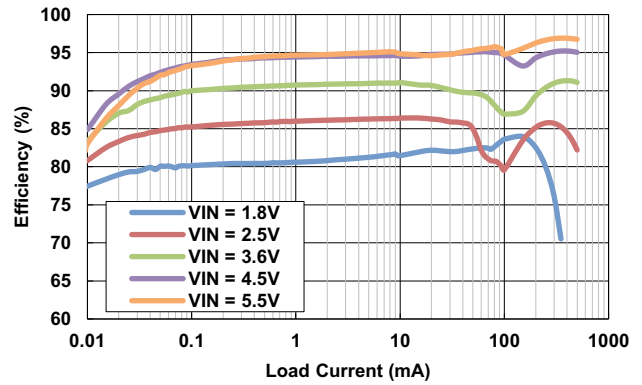

Figure 5. Efficiency vs Load Current:  $V_{OUT} = 5.0V$

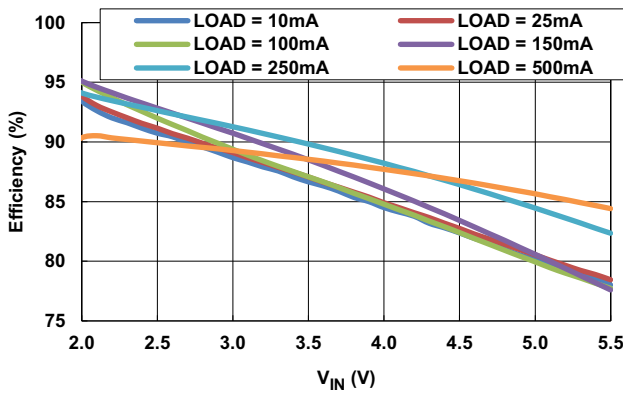

Figure 6. Efficiency vs Input Voltage:  $V_{OUT} = 1.8V$

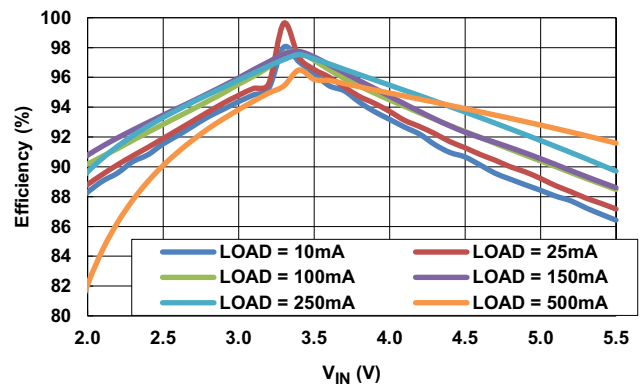

Figure 7. Efficiency vs Input Voltage:  $V_{OUT} = 3.3V$

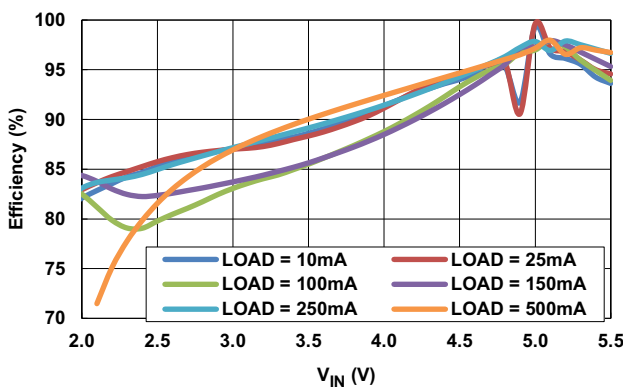

Figure 8. Efficiency vs Input Voltage:  $V_{OUT} = 5V$

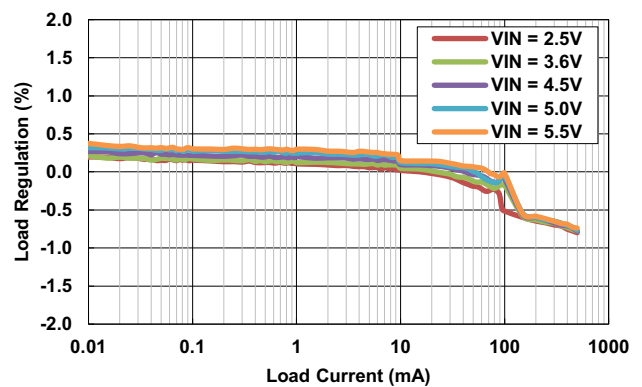

Figure 9. Output Voltage Accuracy vs Load Current:  $V_{OUT} = 1.8V$

$V_{IN} = V_{EN} = 3.6V$ ,  $V_{OUT} = 3.3V$ , I<sup>2</sup>C pull-up voltage = 3.6V, L1 = 1 $\mu$ H/0603, C<sub>1</sub> = C<sub>IN</sub> = 10 $\mu$ F/0603, C<sub>2</sub> = C<sub>OUT</sub> = 22 $\mu$ F/0603, T<sub>A</sub> = +25°C, unless otherwise stated. (Cont.)

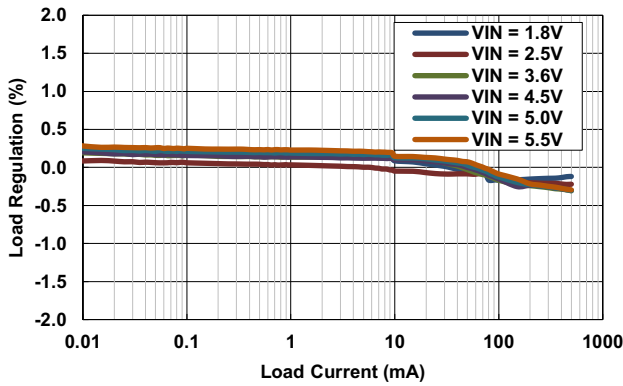

Figure 10. Output Voltage Accuracy vs Load Current:  
 $V_{OUT} = 3.3V$

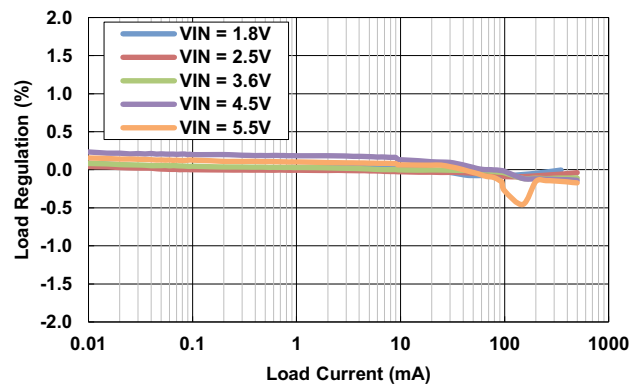

Figure 11. Output Voltage Accuracy vs Load Current:  
 $V_{OUT} = 5V$

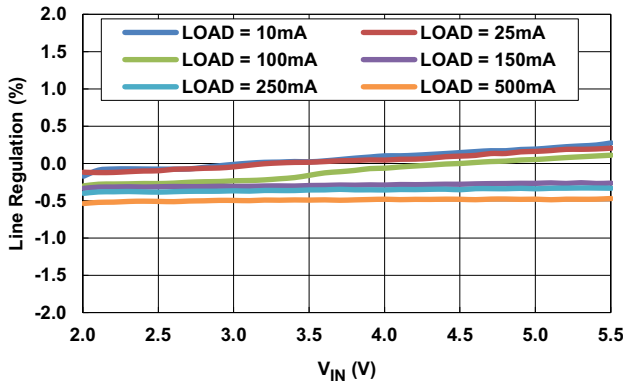

Figure 12. Output Voltage Accuracy vs Input Voltage:  
 $V_{OUT} = 1.8V$

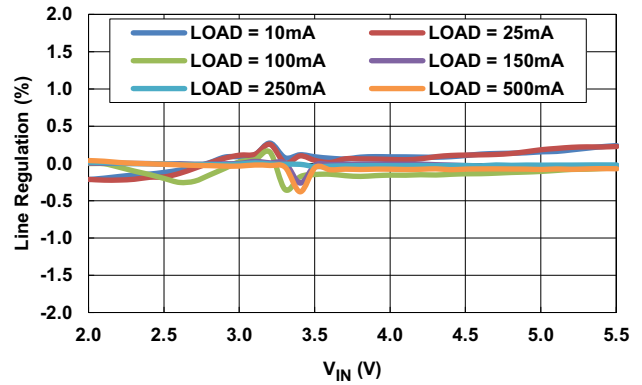

Figure 13. Output Voltage Accuracy vs Input Voltage:  
 $V_{OUT} = 3.3V$

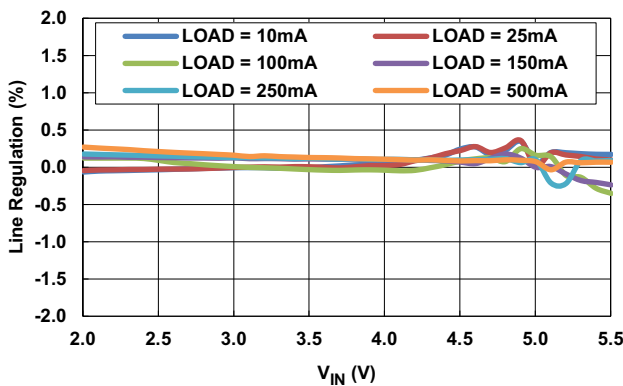

Figure 14. Output Voltage Accuracy vs Input Voltage:  
 $V_{OUT} = 5V$

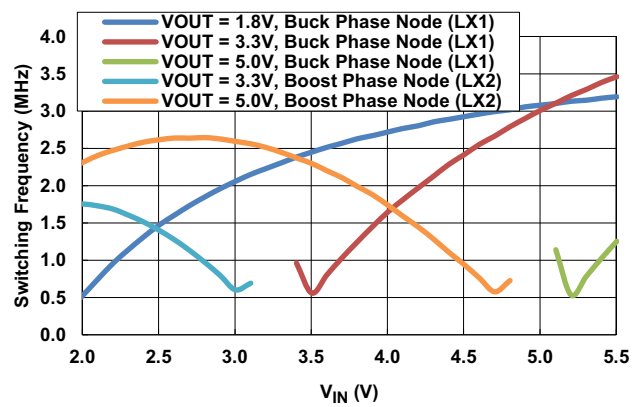

Figure 15. Switching Frequency vs Input Voltage:  
 $I_{OUT} = 0mA$ , Forced PWM

$V_{IN} = V_{EN} = 3.6V$ ,  $V_{OUT} = 3.3V$ , I<sup>2</sup>C pull-up voltage = 3.6V, L1 = 1 $\mu$ H/0603, C<sub>1</sub> = C<sub>IN</sub> = 10 $\mu$ F/0603, C<sub>2</sub> = C<sub>OUT</sub> = 22 $\mu$ F/0603, T<sub>A</sub> = +25 $^{\circ}$ C, unless otherwise stated. (Cont.)

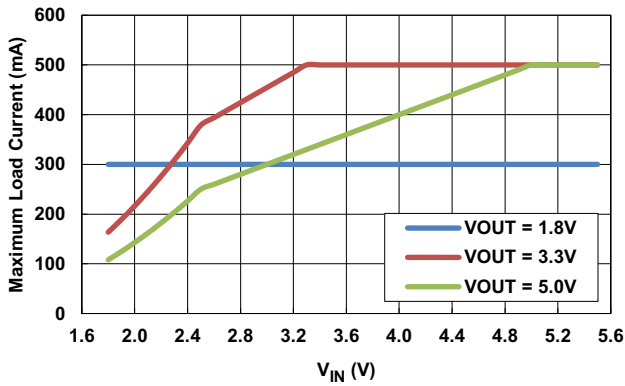

Figure 16. Maximum Load Current vs Input Voltage

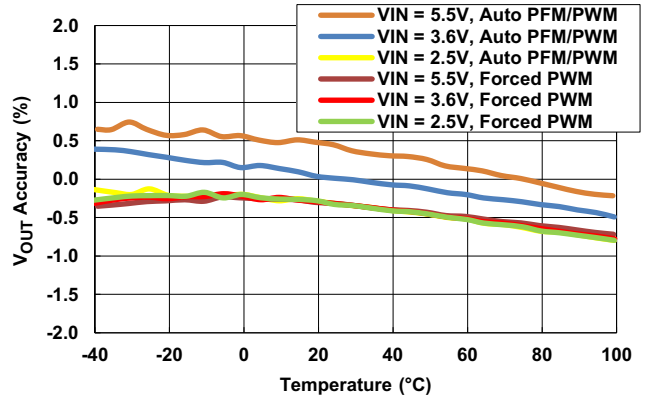

Figure 17. Output Voltage Accuracy vs Temperature:  $V_{SET} = 1.8V$ ,  $I_{OUT} = 25mA$

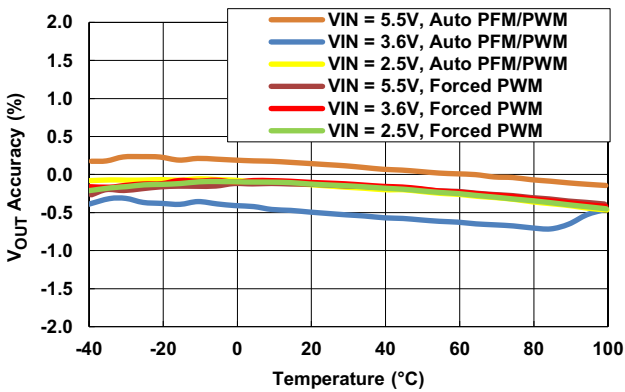

Figure 18. Output Voltage Accuracy vs Temperature:  $V_{SET} = 3.3V$ ,  $I_{OUT} = 25mA$

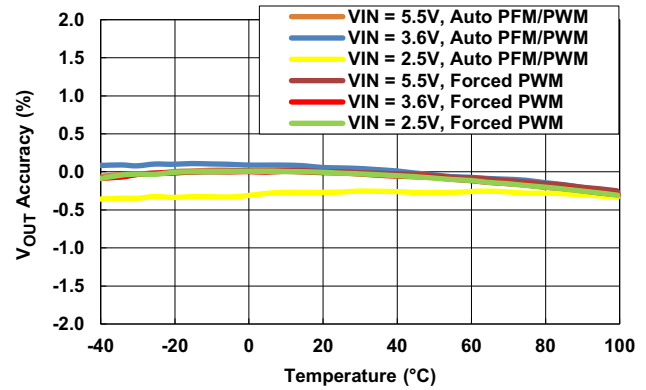

Figure 19. Output Voltage Accuracy vs Temperature:  $V_{SET} = 5V$ ,  $I_{OUT} = 25mA$

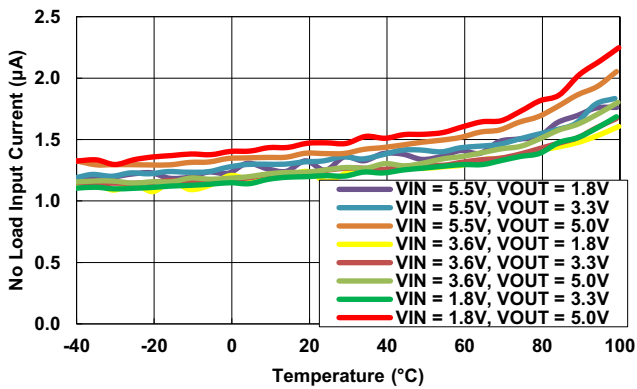

Figure 20. Quiescent Current vs Temperature

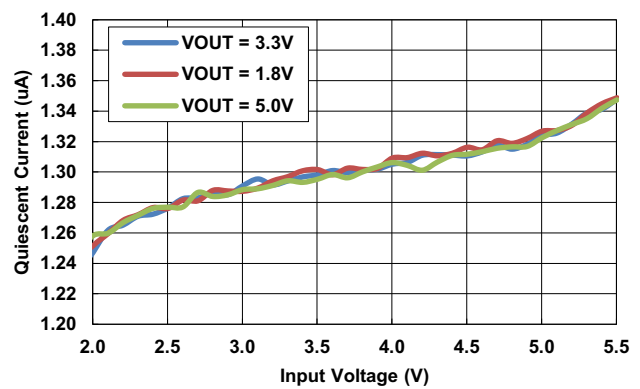

Figure 21. Quiescent Current vs Input Voltage

$V_{IN} = V_{EN} = 3.6V$ ,  $V_{OUT} = 3.3V$ , I<sup>2</sup>C pull-up voltage = 3.6V,  $L1 = 1\mu H/0603$ ,  $C_1 = C_{IN} = 10\mu F/0603$ ,  $C_2 = C_{OUT} = 22\mu F/0603$ ,  $T_A = +25^\circ C$ , unless otherwise stated. (Cont.)

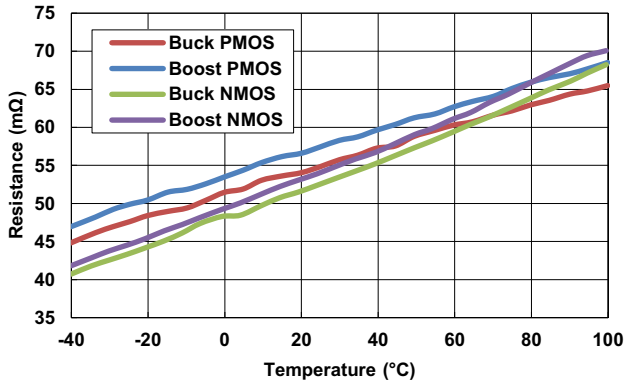

Figure 22. Switch Resistance vs Temperature

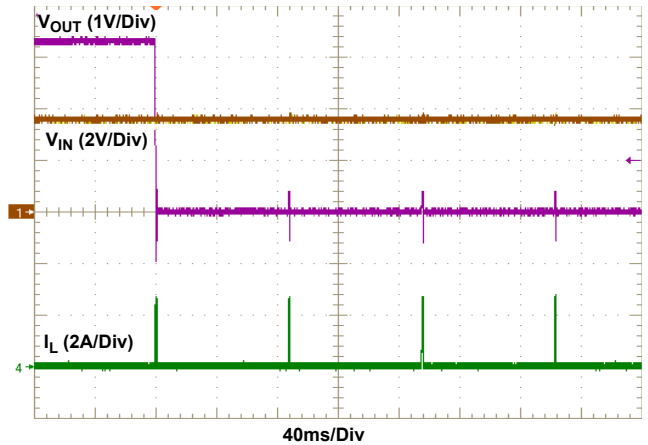

Figure 23. Output Short-Circuit Behavior (Hiccup Mode)

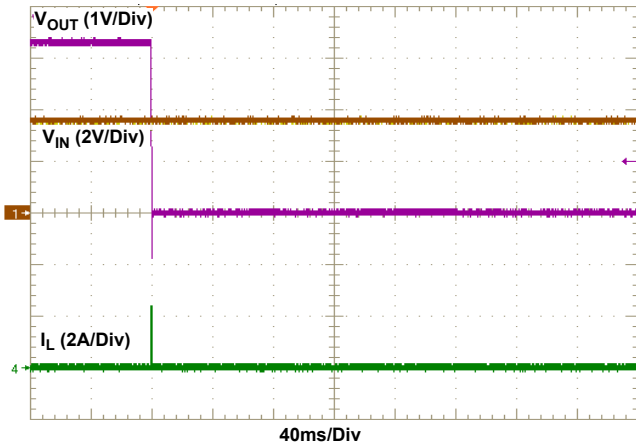

Figure 24. Output Short-Circuit Behavior (Shutdown Mode)

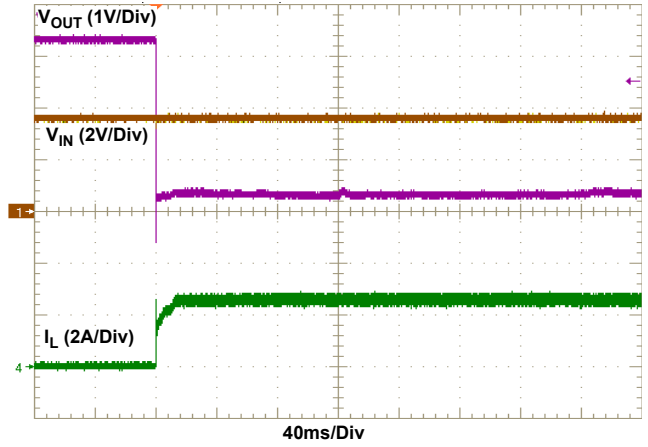

Figure 25. Output Short-Circuit Behavior (Current Limit Mode)

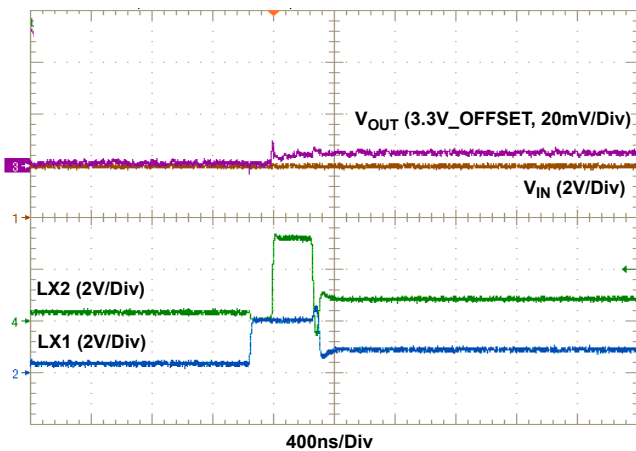

Figure 26. Steady-State Operation in PFM:  $V_{IN} = 2.0V$ ,  $V_{OUT} = 3.3V$ , No Load

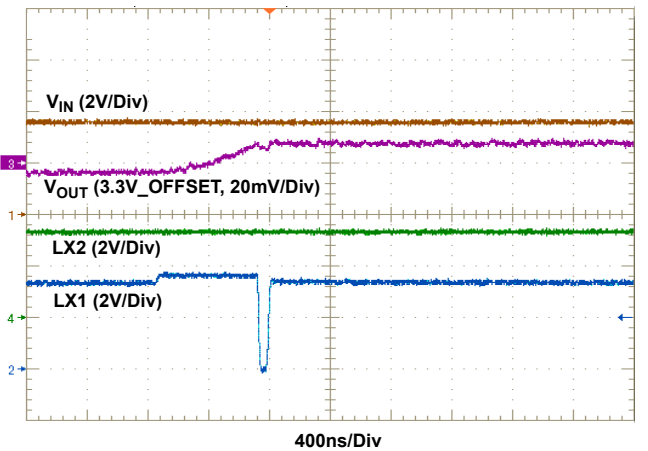

Figure 27. Steady-State Operation in PFM:  $V_{IN} = 3.6V$ ,  $V_{OUT} = 3.3V$ , No Load

$V_{IN} = V_{EN} = 3.6V$ ,  $V_{OUT} = 3.3V$ , I<sup>2</sup>C pull-up voltage = 3.6V,  $L1 = 1\mu H/0603$ ,  $C_1 = C_{IN} = 10\mu F/0603$ ,  $C_2 = C_{OUT} = 22\mu F/0603$ ,  $T_A = +25^\circ C$ , unless otherwise stated. (Cont.)

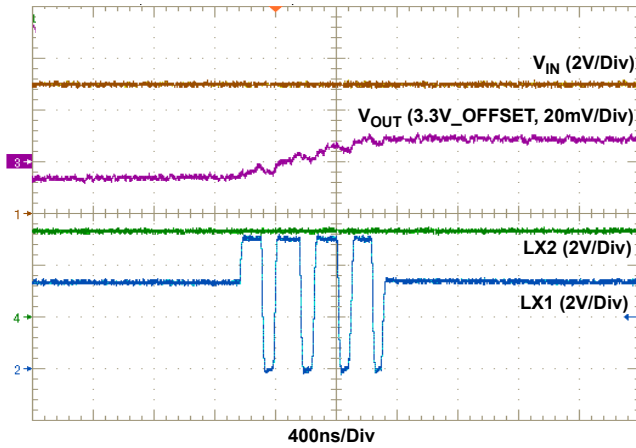

Figure 28. Steady-State Operation in PFM:  $V_{IN} = 5.0V$ ,  $V_{OUT} = 3.3V$ , No Load

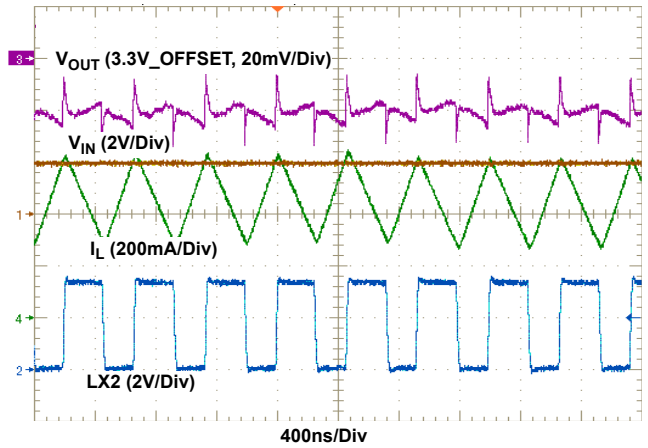

Figure 29. Steady-State Operation in PWM:  $V_{IN} = 2.0V$ ,  $V_{OUT} = 3.3V$ ,  $I_{OUT} = 200mA$

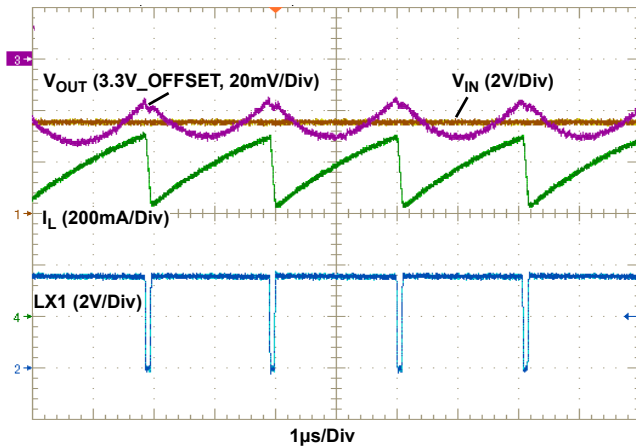

Figure 30. Steady-State Operation in PWM:  $V_{IN} = 3.6V$ ,  $V_{OUT} = 3.3V$ ,  $I_{OUT} = 500mA$

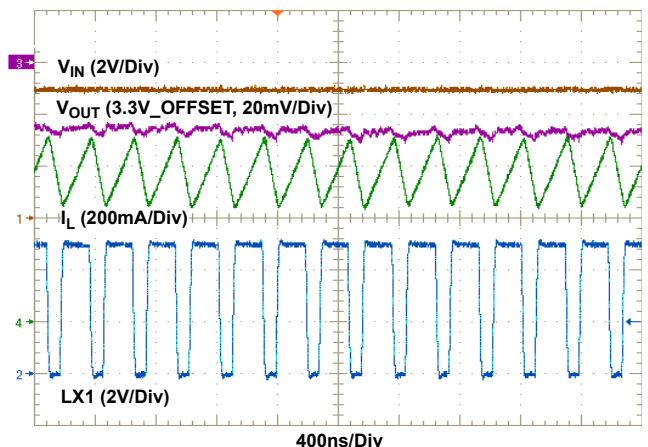

Figure 31. Steady-State Operation in PWM:  $V_{IN} = 5.0V$ ,  $V_{OUT} = 3.3V$ ,  $I_{OUT} = 500mA$

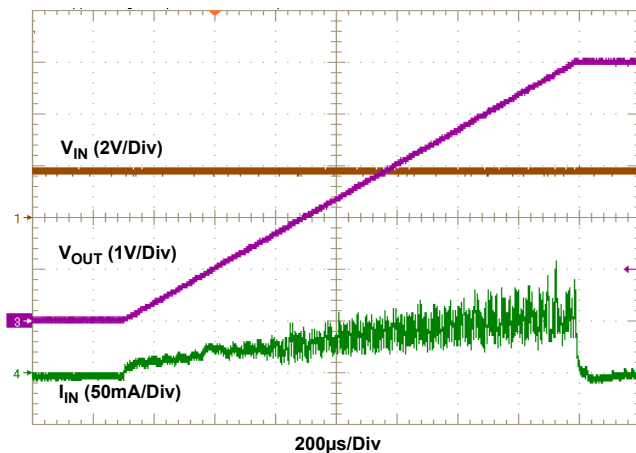

Figure 32. Soft-Start:  $V_{IN} = 1.8V$ ,  $V_{SET} = 5.0V$ , No Load

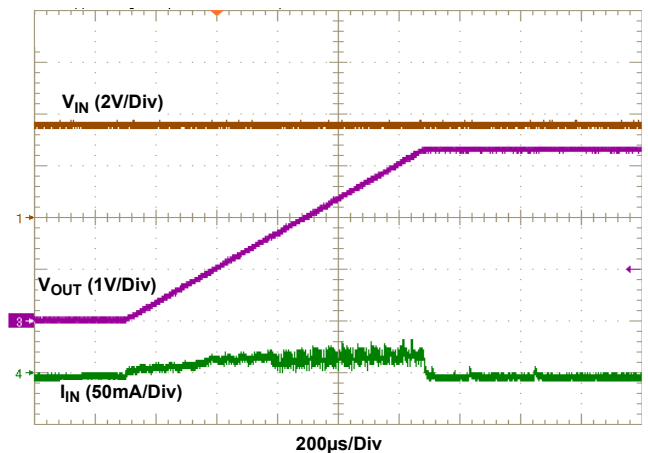

Figure 33. Soft-Start:  $V_{IN} = 3.6V$ ,  $V_{SET} = 3.3V$ , No Load

$V_{IN} = V_{EN} = 3.6V$ ,  $V_{OUT} = 3.3V$ ,  $I^2C$  pull-up voltage = 3.6V,  $L1 = 1\mu H/0603$ ,  $C_1 = C_{IN} = 10\mu F/0603$ ,  $C_2 = C_{OUT} = 22\mu F/0603$ ,  $T_A = +25^\circ C$ , unless otherwise stated. (Cont.)

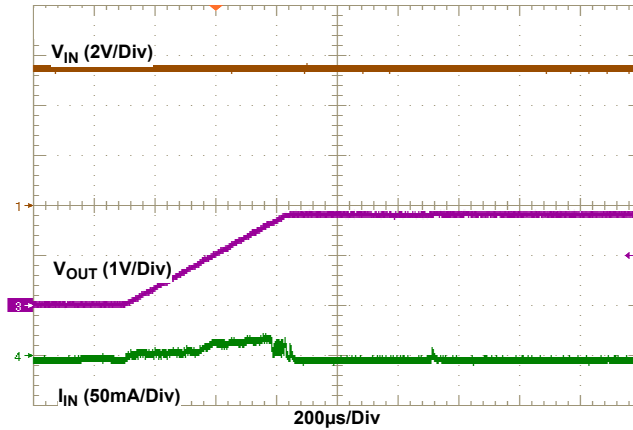

Figure 34. Soft-Start:  $V_{IN} = 5.5V$ ,  $V_{SET} = 1.8V$ , No Load

### 4.1 Line/Load Transient Waveforms

$V_{IN} = V_{EN} = 3.6V$ ,  $V_{OUT} = 3.3V$ ,  $I^2C$  pull-up voltage = 3.6V, Type II Error Amplifier  $L1 = 1\mu H/0603$ ,  $C_1 = C_{IN} = 10\mu F/0603$ ,  $C_2 = C_{OUT} = 22\mu F/0603$ ,  $T_A = +25^\circ C$ , unless otherwise stated.

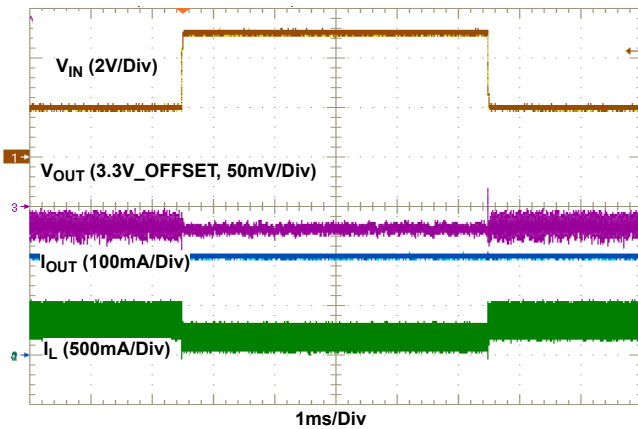

Figure 35. Line Transient:  $V_{IN} = 2.0V$  to  $5.0V$ , Slew Rate =  $0.5V/\mu s$ ,  $V_{OUT} = 3.3V$ ,  $I_{OUT} = 200mA$

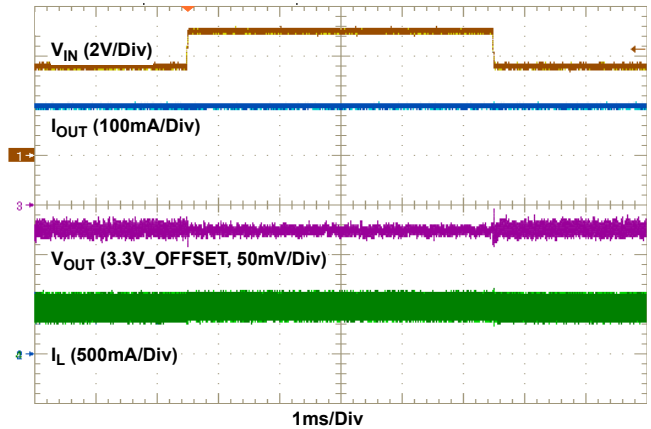

Figure 36. Line Transient:  $V_{IN} = 3.6V$  to  $5.0V$ , Slew Rate =  $0.5V/\mu s$ ,  $V_{OUT} = 3.3V$ ,  $I_{OUT} = 500mA$

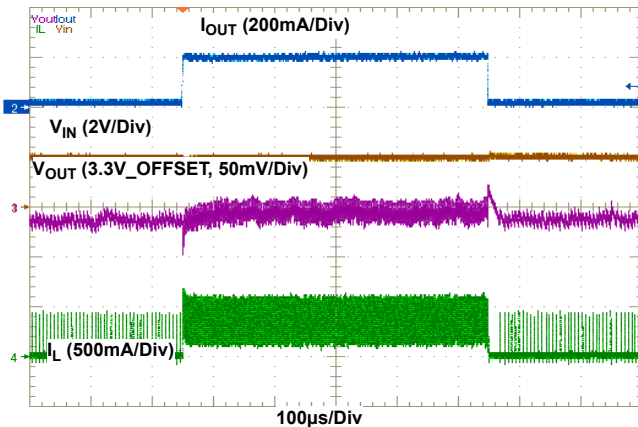

Figure 37. Load Transient:  $V_{IN} = 2.0V$ ,  $V_{OUT} = 3.3V$ ,  $I_{OUT} = 0.01A$  to  $0.20A$ , Slew Rate =  $1A/\mu s$

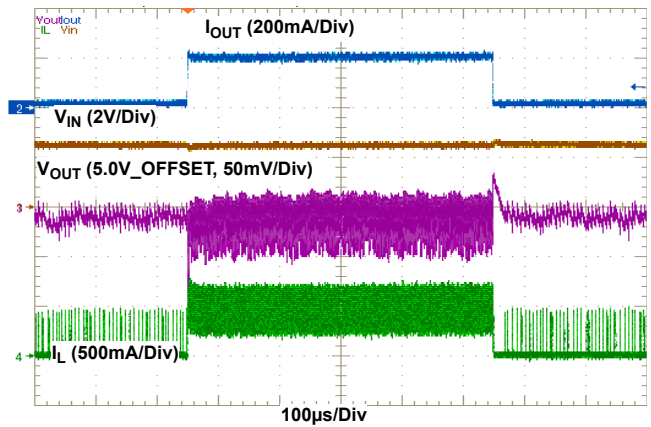

Figure 38. Load Transient:  $V_{IN} = 2.5V$ ,  $V_{OUT} = 5.0V$ ,  $I_{OUT} = 0.01A$  to  $0.20A$ , Slew Rate =  $1A/\mu s$

$V_{IN} = V_{EN} = 3.6V$ ,  $V_{OUT} = 3.3V$ , I<sup>2</sup>C pull-up voltage = 3.6V, Type II Error Amplifier L1 = 1 $\mu$ H/0603, C<sub>1</sub> = C<sub>IN</sub> = 10 $\mu$ F/0603, C<sub>2</sub> = C<sub>OUT</sub> = 22 $\mu$ F/0603, T<sub>A</sub> = +25°C, unless otherwise stated. (Cont.)

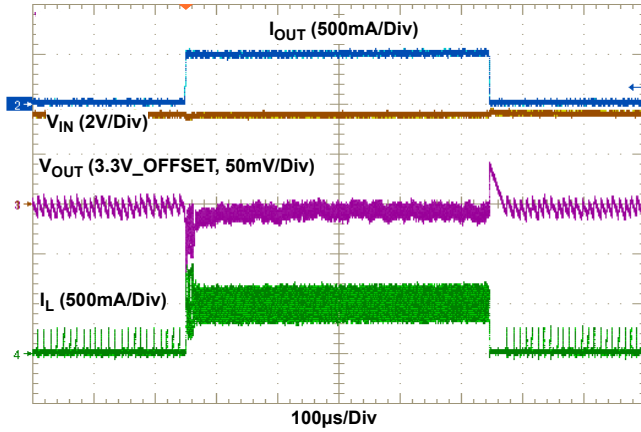

Figure 39. Load Transient:  $V_{IN} = 3.6V$ ,  $V_{OUT} = 3.3V$ ,  $I_{OUT} = 0.01A$  to  $0.50A$ , Slew Rate =  $1A/\mu s$

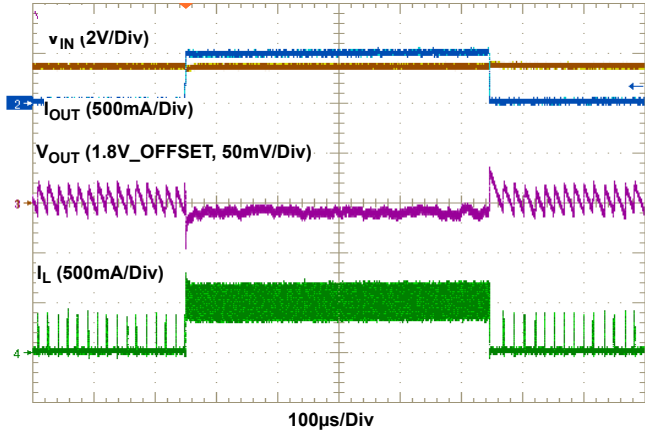

Figure 40. Load Transient:  $V_{IN} = 5.5V$ ,  $V_{OUT} = 3.3V$ ,  $I_{OUT} = 0.01A$  to  $0.50A$ , Slew Rate =  $1A/\mu s$

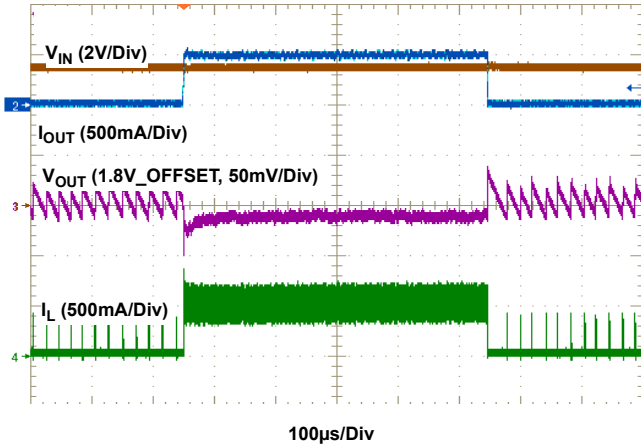

Figure 41. Load Transient:  $V_{IN} = 5.5V$ ,  $V_{OUT} = 1.8V$ ,  $I_{OUT} = 0.01A$  to  $0.50A$ , Slew Rate =  $1A/\mu s$

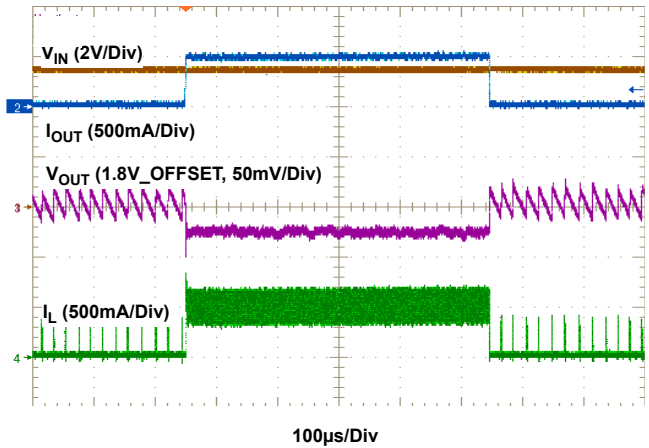

Figure 42. Load Transient:  $V_{IN} = 5.5V$ ,  $V_{OUT} = 1.8V$ ,  $I_{OUT} = 0.01A$  to  $0.50A$ , Slew Rate =  $1A/\mu s$

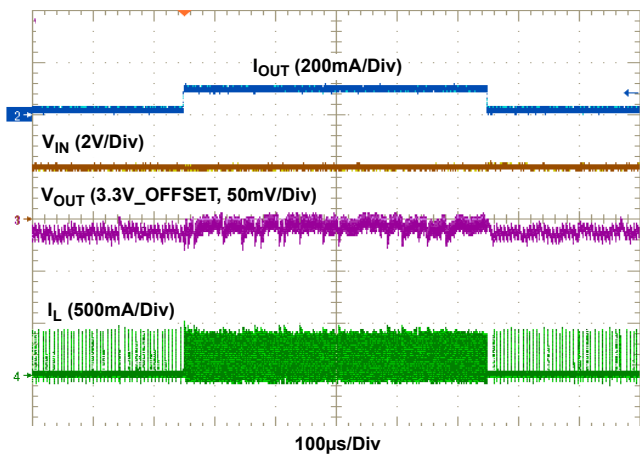

Figure 43. Load Transient:  $V_{IN} = 2.0V$ ,  $V_{OUT} = 3.3V$ ,  $I_{OUT} = 0.01A$  to  $0.10A$ , Slew Rate =  $1A/\mu s$

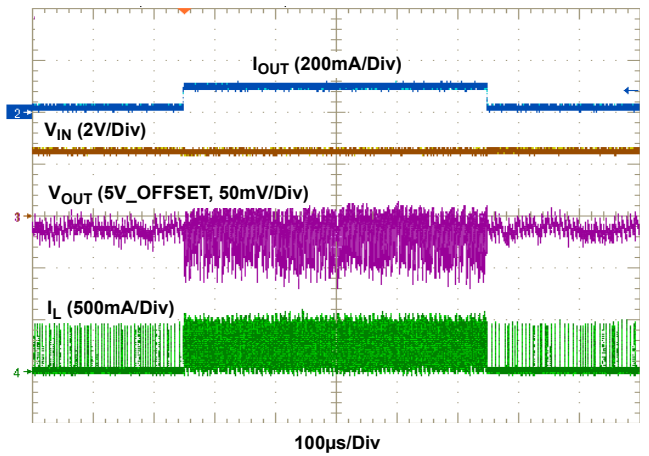

Figure 44. Load Transient:  $V_{IN} = 2.5V$ ,  $V_{OUT} = 5.0V$ ,  $I_{OUT} = 0.01A$  to  $0.10A$ , Slew Rate =  $1A/\mu s$

$V_{IN} = V_{EN} = 3.6V$ ,  $V_{OUT} = 3.3V$ , I<sup>2</sup>C pull-up voltage = 3.6V, Type II Error Amplifier L1 = 1 $\mu$ H/0603, C<sub>1</sub> = C<sub>IN</sub> = 10 $\mu$ F/0603, C<sub>2</sub> = C<sub>OUT</sub> = 22 $\mu$ F/0603, T<sub>A</sub> = +25°C, unless otherwise stated. (Cont.)

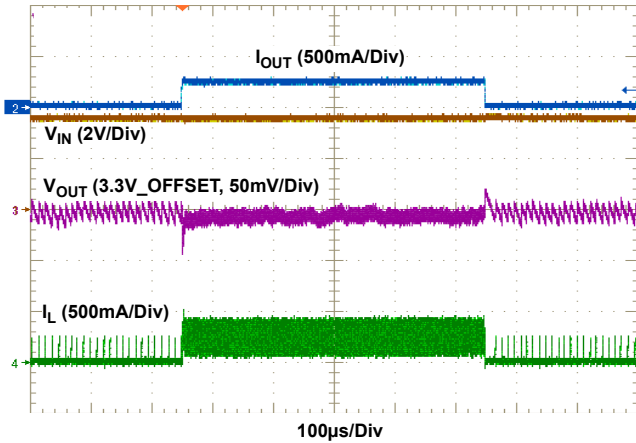

Figure 45. Load Transient:  $V_{IN} = 3.6V$ ,  $V_{OUT} = 3.3V$ ,  $I_{OUT} = 0.01A$  to  $0.25A$ , Slew Rate =  $1A/\mu s$

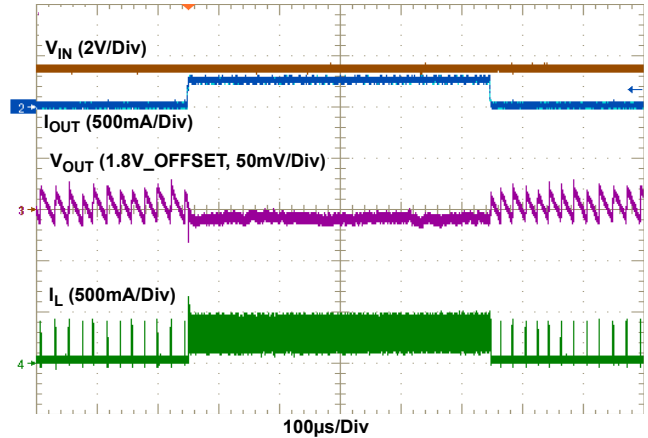

Figure 46. Load Transient:  $V_{IN} = 5.5V$ ,  $V_{OUT} = 1.8V$ ,  $I_{OUT} = 0.01A$  to  $0.25A$ , Slew Rate =  $1A/\mu s$

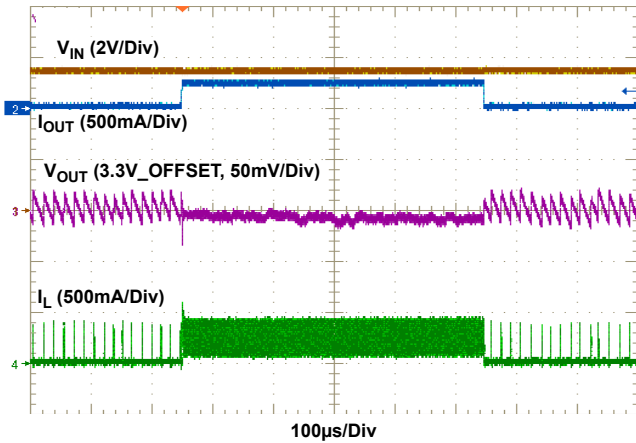

Figure 47. Load Transient:  $V_{IN} = 5.5V$ ,  $V_{OUT} = 3.3V$ ,  $I_{OUT} = 0.01A$  to  $0.25A$ , Slew Rate =  $1A/\mu s$

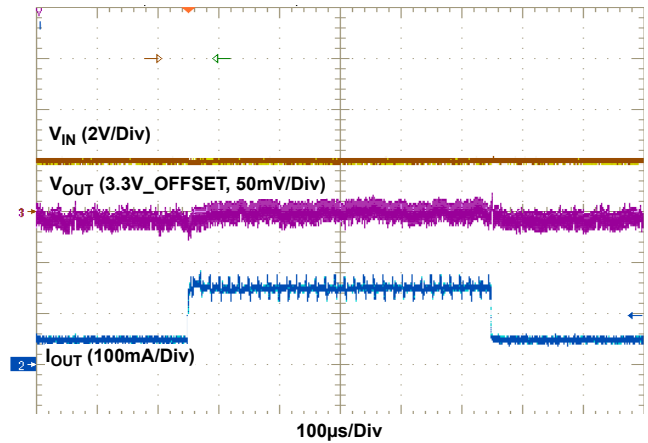

Figure 48. Load Transient:  $V_{IN} = 2.0V$ ,  $V_{OUT} = 3.3V$ ,  $I_{OUT} = 0.05A$  to  $0.15A$ , Slew Rate =  $1A/\mu s$

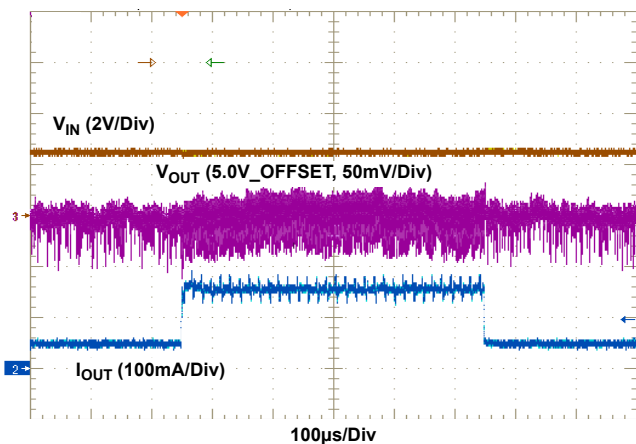

Figure 49. Load Transient:  $V_{IN} = 2.5V$ ,  $V_{OUT} = 5.0V$ ,  $I_{OUT} = 0.05A$  to  $0.15A$ , Slew Rate =  $1A/\mu s$

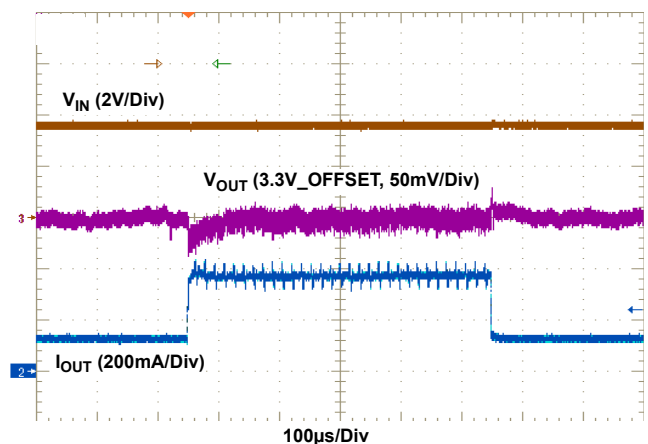

Figure 50. Load Transient:  $V_{IN} = 3.6V$ ,  $V_{OUT} = 3.3V$ ,  $I_{OUT} = 0.125A$  to  $0.375A$ , Slew Rate =  $1A/\mu s$

$V_{IN} = V_{EN} = 3.6V$ ,  $V_{OUT} = 3.3V$ , I<sup>2</sup>C pull-up voltage = 3.6V, Type II Error Amplifier L1 = 1 $\mu$ H/0603, C<sub>1</sub> = C<sub>IN</sub> = 10 $\mu$ F/0603, C<sub>2</sub> = C<sub>OUT</sub> = 22 $\mu$ F/0603, T<sub>A</sub> = +25°C, unless otherwise stated. (Cont.)

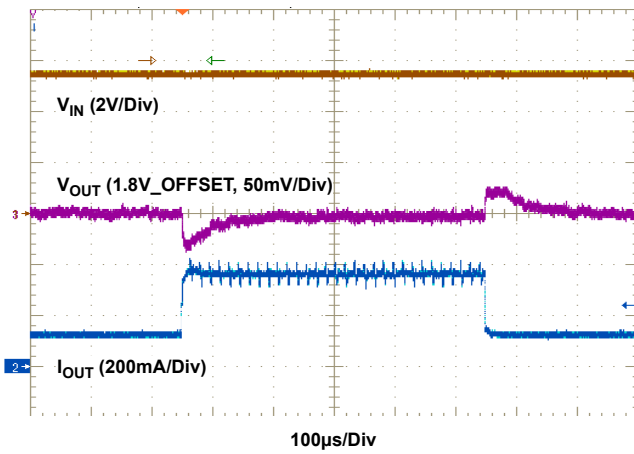

Figure 51. Load Transient:  $V_{IN} = 5.5V$ ,  $V_{OUT} = 1.8V$ ,  $I_{OUT} = 0.125A$  to  $0.375A$ , Slew Rate =  $1A/\mu s$

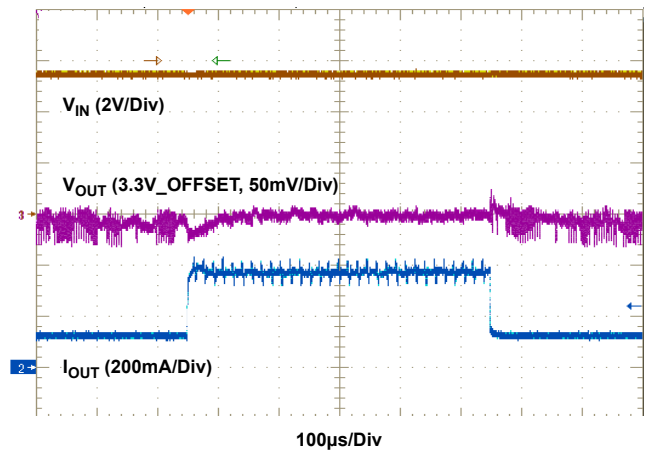

Figure 52. Load Transient:  $V_{IN} = 5.5V$ ,  $V_{OUT} = 3.3V$ ,  $I_{OUT} = 0.125A$  to  $0.375A$ , Slew Rate =  $1A/\mu s$

## 5. Functional Description

The ISL9122A implements a complete buck-boost switching regulator, with PWM controller, internal switches, references, protection circuitry, and control inputs. See the [Block Diagram](#).

The PWM controller automatically switches between Buck and Boost modes as necessary, to maintain a steady output voltage with changing input voltages and dynamic external loads.

### 5.1 Enable Input

The device is enabled by asserting the EN pin HIGH. Driving EN LOW invokes Power-Down mode, in which most internal device functions are disabled. EN must remain LOW for at least 50 $\mu$ s for the device to be disabled. When the device is disabled by driving EN LOW, the output discharges naturally based on the load current.

*Note:* The I<sup>2</sup>C interface is disabled when EN is LOW.

### 5.2 Soft Discharge

Whenever the converter is disabled over I<sup>2</sup>C, an internal discharge resistor between VOUT and GND can be activated to slowly discharge the output capacitor. This internal discharge resistor has a typical resistance of 160 $\Omega$ . The soft discharge function is accessed using I<sup>2</sup>C while keeping the EN pin high. Using the CONV\_CFG register, set the DISCH bit to 1 and disable the IC by setting the EN\_AND bit to 0. (See [Table 5](#) for details).

### 5.3 Startup

When the input voltage rises above the undervoltage lockout threshold and EN is asserted high, the power-on sequence starts. First, the IC is initialized and its One-Time Programmable (OTP) memory is read. After the OTP has been read and the controller knows the target output voltage and ramp rate, soft-start begins and the output voltage rises at the programmed ramp rate until it reaches the target output voltage. Cycling of the EN pin while VIN remains valid restarts the power-on sequence, which includes reading OTP.

### 5.4 Overcurrent/Short-Circuit Protection

The ISL9122A provides overcurrent protection by monitoring the inductor current. When the peak inductor current hits its current limit, the IC enters Hiccup mode, Shutdown, or Current Limit mode according to the setting of the OC\_FAULT\_MODE bits in the INT\_FLAG\_MASK register.

During Hiccup mode, the IC shuts down for 100ms and then tries to restart. If it encounters the overcurrent condition again, it shuts down and tries to restart after another 100ms. This cycle keeps repeating until there is no overcurrent and VOUT can then come back up.

In Shutdown mode, the IC shuts down whenever overcurrent is encountered and the only way to bring the output voltage up is to restart the part by either cycling VIN, or EN, or by resetting and then setting the EN\_AND bit in the CONV\_CFG register, to mimic EN cycling behavior.

In Current Limit mode, the IC provides the maximum current it can, while respecting the peak current limit. If the load demand is even more, the IC starts dropping the output voltage while supplying the same maximum current.

### 5.5 Thermal Shutdown

The ISL9122A features a thermal shutdown that protects the device from damage because of overheating. An integrated temperature sensor circuit monitors the internal IC temperature. When the temperature exceeds T<sub>SD</sub>, the device stops switching and waits for the temperature to fall. When the temperature falls by T<sub>SDHYS</sub>, the controller first goes through the soft-start phase and then starts regulating at the target output voltage as defined by the I<sup>2</sup>C register value.

## 5.6 Buck-Boost Conversion Topology

The ISL9122A operates in either a pure Buck or a pure Boost mode. When operating in conditions in which  $V_{IN}$  is close to  $V_{OUT}$ , the ISL9122A alternates between Buck and Boost modes, as necessary, to provide a regulated output voltage.

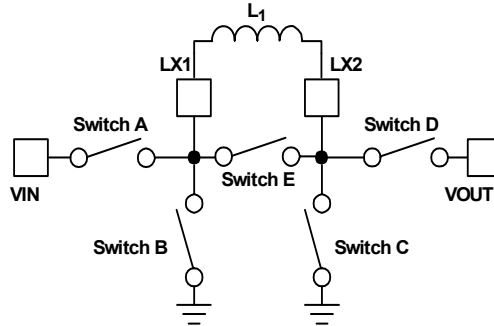

Figure 53. Buck-Boost Topology

Figure 53 shows a simplified diagram of the internal switches and external inductor.

## 5.7 Pulse Width Modulation (PWM) Operation

In Buck PWM mode, Switch D is kept permanently closed and Switch C permanently open. Switches A and B operate as in a synchronous buck converter. Initially Switch A is turned ON and this ramps up the inductor current with a slope of  $(V_{IN} - V_{OUT})/L$  (in buck mode,  $V_{IN} > V_{OUT}$ ). When the inductor current hits the upper threshold, as dictated by the hysteretic controller, Switch A is turned OFF. This is followed by a small dead-time where both the switches are OFF. During this interval, the inductor current keeps flowing, finding its path through the body diode of Switch B. When the dead-time is over, Switch B is turned ON and the inductor current ramps down with a slope of  $-(V_{OUT})/L$ . When it hits the lower hysteretic threshold, Switch B is turned OFF, followed by another dead-time interval. After this, Switch A is turned ON again and the entire sequence repeats.

In Boost PWM mode, Switch A is kept permanently closed and switch B permanently open. Switches C and D operate as in a synchronous boost converter. Initially Switch C is turned ON and this ramps up the inductor current with a slope of  $V_{IN}/L$ . When the inductor current hits the upper threshold, as dictated by the hysteretic controller, Switch C is turned OFF. This is followed by a small dead-time where both the switches are OFF. During this interval, the inductor current keeps flowing, finding its path through the body diode of Switch D. When the dead-time is over, Switch D is turned ON and the inductor current ramps down with a slope of  $(V_{IN} - V_{OUT})/L$  (in boost mode,  $V_{IN} < V_{OUT}$ ). When it hits the lower hysteretic threshold, Switch D is turned OFF, followed by another dead-time interval. After this, Switch C is turned ON again and the entire sequence repeats.

The converter operates in PWM mode under two conditions: load is sufficiently high in the Normal Mode (Auto PFM/PWM mode) OR Forced PWM mode is enabled by setting the FMODE bits in CONV\_CFG register to 0x2.

The optimal switching frequency is determined by the hysteretic controller and is centered around 2.5MHz, for  $V_{IN} = 3.6V$  and  $V_{OUT} = 1.8V$ .

## 5.8 Pulse Frequency Modulation (PFM) Operation

During PFM operation in Buck mode, Switch C is permanently open. Switches A, B, and D operate in Discontinuous Conduction Mode (DCM). Like the Buck PWM operation, Switch A is turned ON, followed by a dead-time, and then Switch B is turned ON. The inductor current ramps up and down, respectively, and the energy in this current pulse charges up  $V_{OUT}$ . After this, unlike the PWM operation, switches A, B, and D remain OFF until  $V_{OUT}$  discharges down to the lower threshold of the hysteretic controller. The switching cycle repeats after that.

During PFM operation in Boost mode, unlike Buck mode, Switch B remains permanently open. Switches A, C, and D operate in DCM. At the start of the PFM pulse, Switch A is turned ON. Then, just like the Boost PWM operation, Switch C is turned ON, followed by a dead time, and then Switch D is turned ON. The inductor current ramps up and down, respectively, and the energy in this current pulse charges up  $V_{OUT}$ . After this, unlike the PWM operation, switches A, B, and D are turned OFF until  $V_{OUT}$  discharges down to the lower threshold of the hysteretic controller. When switches A, B, C, and D are OFF, switch E is turned on to damp ringing on the LX node. The switching cycle repeats after that.

Multiple switching pulses are needed to charge up the output capacitor in some operating conditions. These pulses continue until  $V_{OUT}$  has achieved the upper threshold of the PFM hysteretic controller. Switching then stops and remains stopped until  $V_{OUT}$  decays to the lower threshold. As load increases, the frequency of PFM pulses increases as  $V_{OUT}$  gets discharged faster and needs to be recharged more often. This continues until the PFM pulses start bunching together, and the part then enters sustained PWM operation. The converter operates in PFM mode under only one condition: load is light enough in the Normal Mode (Auto PFM/PWM mode).

The PFM-PWM transition, going from light to heavy load and then back to light load, has a hysteretic band. This transition allows for a seamless PFM to PWM and PWM to PFM transition.

## 5.9 Operation With $V_{IN}$ Close to $V_{OUT}$

When the output voltage is close to the input voltage, the ISL9122A rapidly and smoothly switches between Boost, Bypass, and Buck modes to maintain the regulated output voltage. This behavior provides excellent efficiency and low output voltage ripple.

## 5.10 Forced Operating Modes

Forced operating modes include Forced PWM mode and Forced Bypass mode. Forced operating modes are selected using the FMODE bits in the CONV\_CFG register (See Table 5 for details). The power-up default mode is Normal operation with automatic mode transitions to optimize efficiency.

Forced PWM mode can be selected to minimize the switching frequency variation and to obtain a tight  $V_{OUT}$  accuracy, although this comes at the expense of increased input current.

Forced Bypass mode can be selected to minimize power losses when output voltage regulation is not required. When the device enters Bypass mode, both Switches A, D, and E are turned ON, providing a direct path from the input to output through the inductor. In Bypass mode, all other blocks, except POR and I<sup>2</sup>C, are turned off to minimize quiescent current consumption. If the part has to repeatedly bounce between the Forced Bypass and Regulation modes, there should be at least 1ms delay between the successive mode setting I<sup>2</sup>C commands.

*Note:* There is no overcurrent protection in Bypass mode.

## 5.11 I<sup>2</sup>C Serial Interface

The ISL9122A supports a bidirectional bus-oriented protocol. The protocol defines any device that sends data onto the bus as a transmitter and the receiving device as the receiver. The device controlling the transfer is the master and the device being controlled is the slave. The master always initiates data transfers and provides the clock for both transmit and receive operations. Therefore, the ISL9122A operates as a slave device in all applications.

The IC supports the following data transfers rates and modes as defined in the I<sup>2</sup>C specification:

- Up to 100kbit/s in Standard mode
- Up to 400kbit/s in Fast mode

All communication over the I<sup>2</sup>C interface is conducted by sending the MSB of each byte of data first.

The I<sup>2</sup>C pull-up voltage may be from 1.8V to 5.5V. However, input quiescent current increases by up to 1μA (typical), 3μA (max), if the I<sup>2</sup>C pull-up voltage is less than V<sub>IN</sub>. There is no increase in the quiescent current if the I<sup>2</sup>C pins are pulled down to ground.

### 5.11.1 Protocol Conventions

Data states on the SDA line can change only during SCL LOW periods. The SDA state changes during SCL HIGH are reserved for indicating START and STOP conditions (see Figure 54). At power-up the SDA pin is in input mode.

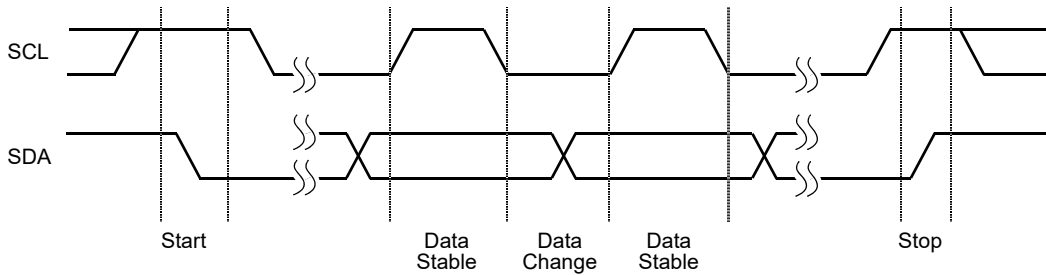

Figure 54. Valid Data Changes, Start, and Stop Conditions

All I<sup>2</sup>C interface operations must begin with a START condition, which is a HIGH to LOW transition of SDA while SCL is HIGH. The ISL9122A continuously monitors the SDA and SCL lines for the START condition and does not respond to any command until this condition is met (see Figure 54). A START condition is ignored during the power-up sequence and when EN input is low.

All I<sup>2</sup>C interface operations must be terminated by a STOP condition, which is a LOW to HIGH transition of SDA while SCL is HIGH (see Figure 54).

An acknowledge (ACK) is a software convention used to indicate a successful data transfer. The transmitting device, either master or slave, releases the SDA bus after transmitting eight bits. During the ninth clock cycle, the receiver pulls the SDA line LOW to acknowledge the reception of the eight bits of data (see Figure 55), and the data is latched in and responded to by the ISL9122A.

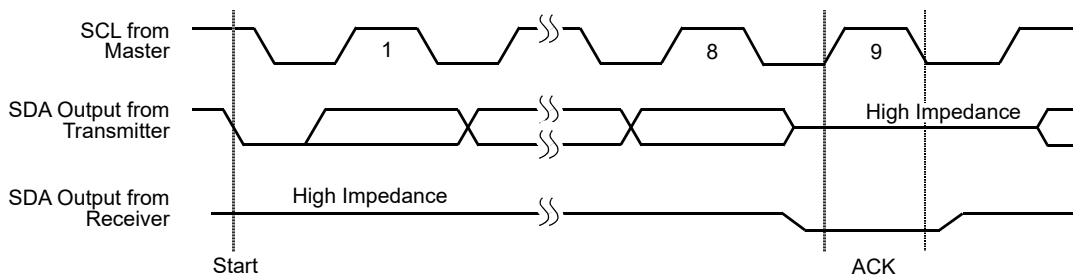

Figure 55. Acknowledge Response from Receiver

The ISL9122A responds with an ACK after recognizing a START condition followed by a valid 7-bit slave address, and once again after successful receipt of a register address byte. The ISL9122A again responds with an ACK after receiving a data byte of a write operation. The master must respond with an ACK after receiving a data byte of a read operation.

For the base version, the 7-bit slave address is set in trim to 0x18. The 7-bit address is followed by a Read/Write bit whose value is 1 for a Read operation, and 0 for a Write operation (see Table 1).

Table 1. 7-Bit Address Format

0	0	1	1	0	0	0	R/W
(MSB)							(LSB)

### 5.11.2 Write Operation

Write operations are shown in Figure 56. A write operation requires a START condition, followed by a valid 7-bit slave address with the R/W bit set to 0, a valid register address byte, one or more data bytes, and a STOP condition. After each of the bytes, the ISL9122A responds with an ACK. After each data byte is acknowledged, the ISL9122A increments its register address to support block writes. The master sends a STOP to complete the command.

STOP conditions that terminate write operations must be sent by the master after sending at least one full data byte and its associated ACK signal. If a STOP condition is issued in the middle of a data byte, or before one full data byte + ACK is sent, the ISL9122A ignores the command and does not change the output voltage or other settings.

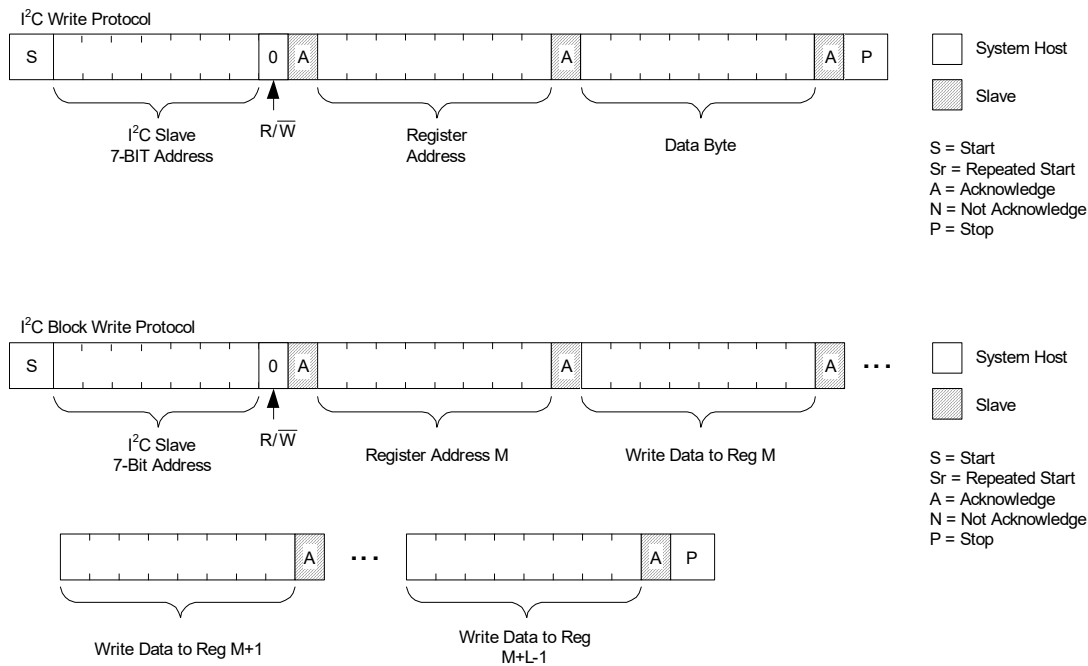

Figure 56. I2C Register Write Protocols

### 5.11.3 Read Operation

Read operations are shown in Figure 57. They consist of four or more bytes. The host generates a START condition, then transmits the 7-bit slave address with the R/W bit set to 0. The ISL9122A responds with an ACK. The host then transmits the register address byte, and the ISL9122A responds with another ACK.

The host then generates a repeat START condition and transmits the 7-bit slave address with the R/W bit set to 1. The ISL9122A responds with an ACK, indicating it is ready to provide the requested data.

The ISL9122A then transmits the data byte by asserting control of the SDA pin while the host generates clock pulses on the SCL pin. After each data byte is complete the host generates an ACK condition. After every successfully transmitted data byte the ISL9122A automatically increments its internal register address to support block reads. The host terminates the Read operation by issuing a NACK and sending a STOP condition.

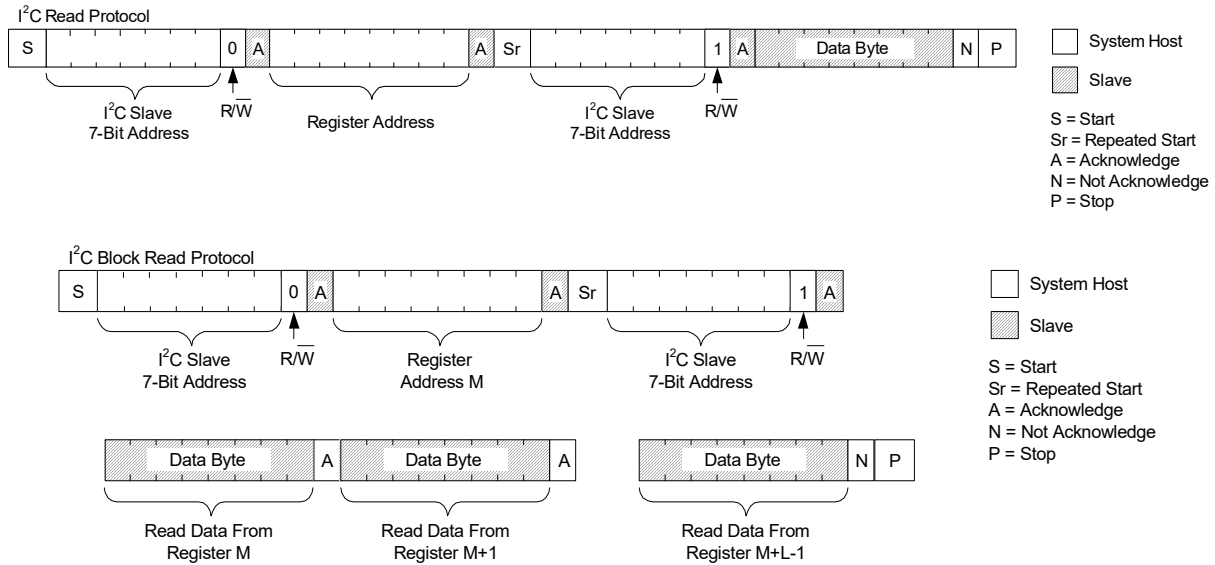

Figure 57. I<sup>2</sup>C Register Read Protocols

## 6. Register Descriptions

The ISL9122A has I<sup>2</sup>C accessible control registers whose functions are described in [Table 2](#) through [Table 6](#). These registers can be accessed any time the ISL9122A is enabled. When the ISL9122A is disabled (EN = LOW), or loading OTP, attempts to communicate through its I<sup>2</sup>C interface are not supported.

### 6.1 RO\_REG1

The RO\_REG1 register contains the hardware identification bits as described in [Table 2](#).

Table 2. Register Address 0x02: RO\_REG1

Bit	Name	Type	Reset	Description
7:6	FAMILY_ID[1:0]	R	0x1	Chip family identifier 0x1 = ISL9122 stand-alone converter family (ISL9122A rev.E only)
5:3	HW_REV[2:0]	R	0x4	Chip revision level 0x4 = Hardware revision E
2:0	RAIL_VAR[2:0]	R	0x0	Converter variant identifier 0x0 = High voltage input Buck-Boost (ISL9122A)

## 6.2 INTFLG\_REG

The INTFLG\_REG register contains fault flags. Each bit represents a different type of fault as described in [Table 3](#). A 0 indicates no fault, and a 1 indicates a fault. Each bit is set by a fault event and is cleared when read. When a fault flag is read back and asserted (1), it indicates a fault occurred in the past. Read the flag again to examine the current IC status – occurring in the time between the first and second I<sup>2</sup>C read. Continuing to poll the flags provides period updates of the IC status relative to the previous read-back.

**Table 3. Register Address 0x03: INTFLG\_REG**

Bit	Name	Type	Reset	Description
3	INT3	R	0x0	Voltage setting under range. Sets to 1 when VSET changes from within the 0x48-0xD7 range to below 0x48.
2	INT2	R	0x0	Voltage setting over range. Sets to 1 when VSET changes from within the 0x04-0xD7 range to above 0xD7.
1	INT1	R	0x0	Over-temperature
0	INT0	R	0x0	Overcurrent

## 6.3 VSET

The VSET register contains the output voltage setting in 25mV steps as shown in [Equation 1](#). VSET can be changed after the IC is enabled and operating. When the output voltage is changed, it ramps at the rate set in the DVSRATE bits of CONV\_CFG register.

$$(EQ. 1) \quad V_{OUT} = VSET \times 0.025V$$

The output voltage range is digitally limited to be between the minimum and maximum values shown in [Table 4](#). Setting values above or below the limits results in the output voltage ramping to the limit and the appropriate overvoltage or undervoltage interrupt flag in INTFLG\_REG being set.

**Table 4. Register Address 0x11: VSET**

Bit	Name	Type	Reset <sup>[1]</sup>	Description
7:0	VSET[7:0]	R/W	-	Output voltage setting (25mV steps): Minimum limit = 1.8V (0x48) Maximum limit = 5.375V (0xD7)

1. For part specific default output voltage, see the [Ordering Information](#) table.

## 6.4 CONV\_CFG

The CONV\_CFG register settings are described in [Table 5](#).

**Table 5. Register Address 0x12: CONV\_CFG**

Bit	Name	Type	Reset	Description
7	EN_AND	R/W	0x1	Enable bit. ANDed with the enable input 0x0 = EN pin going high wakes up the I <sup>2</sup> C, but does not start the converter. The converter is started by writing 1 to this bit using I <sup>2</sup> C while the EN pin is high 0x1 = EN pin going high wakes up the I <sup>2</sup> C and starts the converter <i>Note:</i> EN pin low always disables the converter and I <sup>2</sup> C
6	DISCH	R/W	0x0	0x0 = No discharge resistor present when converter is disabled over I <sup>2</sup> C 0x1 = Discharge resistor present when converter is disabled over I <sup>2</sup> C
5:4	DVSRATE[1:0]	R/W	0x0	Dynamic Voltage Scaling slew rate applied when the output voltage setting is changed. 0x0 = 3.125mV/μs 0x1 = 6.25mV/μs 0x2 = 0.78125mV/μs 0x3 = 1.5625mV/μs
3:2	FMODE[1:0]	R/W	0x0	Forced operating modes 0x0 = Normal operation with automatic mode transitions 0x1 = RESERVED. DO NOT USE this combination 0x2 = Forced PWM mode with no PFM operation 0x3 = Forced bypass. Disables switching. If the Forced Bypass mode is selected and the part is disabled over I <sup>2</sup> C (CONV_CFG[7] = EN_AND = 0x0), the converter remains in Forced Bypass
1	CONV_RSVD	R/W	0x0	Reserved. Do not use.
0	TYPE1	R/W	0x1	0x0 = Type I error amplifier for best transient response with voltage positioning 0x1 = Type II error amplifier for best steady state voltage accuracy. <b>DO NOT USE</b> Type II error amplifier if overcurrent fault handling is disabled (INTFLG_MASK[7] = OC_FAULT_MODE = 0x2 or 0x3)

## 6.5 INTFLG\_MASK

The INTFLG\_MASK register settings are described in [Table 6](#).

**Table 6. Register Address 0x13: INTFLG\_MASK**

Bit	Name	Type	Reset	Description
7:6	OC_FAULT_MODE[1:0]	R/W	0x0	Overcurrent fault handling modes 0x0 = Hiccup mode with 100ms wait 0x1 = Shutdown mode. Requires restart over I <sup>2</sup> C or EN pin 0x2 = Current limit with no fault action taken. USE ONLY with Type I error amplifier (CONV_CFG[0] = TYPE1 = 0x0) 0x3 = Reserved.
5	EN_OR	R/W	0x0	Enable override bit for I <sup>2</sup> C control of the converter. Implements push-button ON operation; the button pulls EN high and the part starts. If EN_OR is set from OTP or over I <sup>2</sup> C, the part remains enabled when the button is released 0x0 = Controlled by the EN pin 0x1 = Held in enable state - EN pin is ignored

## 7. Package Outline Drawings

For the most recent package outline drawing, see [W2x4.8](#).

W2x4.8

8 Ball Wafer Level Chip Scale Package (WLCSP) 0.4mm Pitch

Rev 0, 6/17

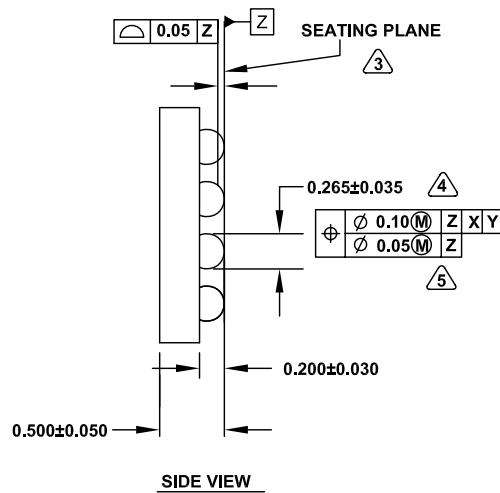
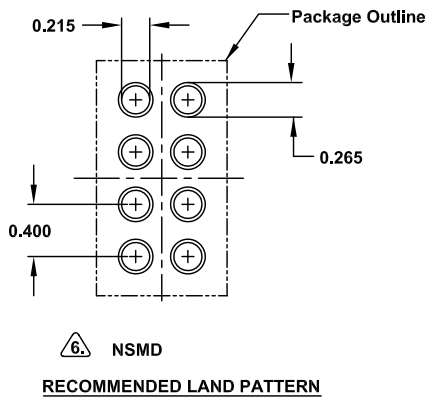
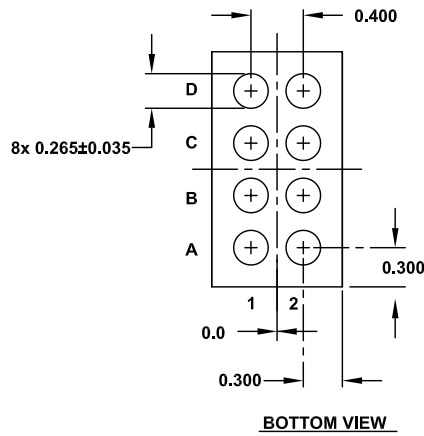
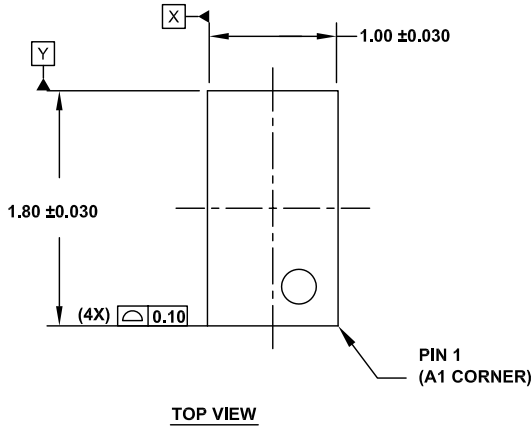

**NOTES:**

1. All dimensions are in millimeters.
2. Dimensions and tolerances per ASMEY 14.5-1994
3. Primary datum Z and seating plane are defined by the spherical crowns of the bump.
4. Dimension is measured at the maximum bump diameter parallel to primary datum Z.
5. Bump position designation per JESD 95-1, SPP-010.
6. NSMD refers to non-solder mask defined pad design per Intersil Techbrief. <http://www.intersil.com/data/tb/tb451.pdf>

For the most recent package outline drawing, see [L8.2x3](#).

L8.2x3

8 Lead Dual Flat No-Lead Plastic Package

Rev 2, 3/15

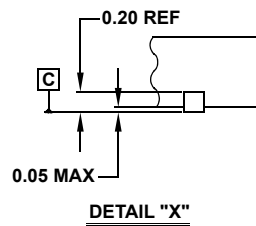
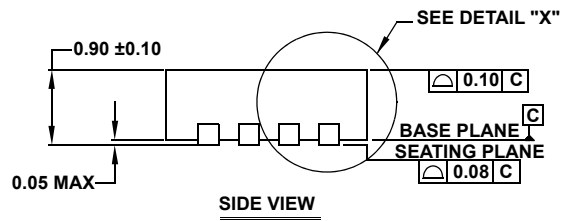
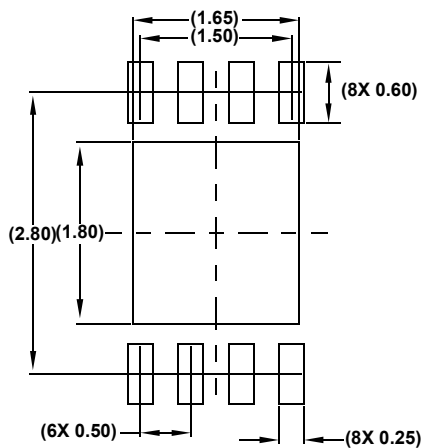
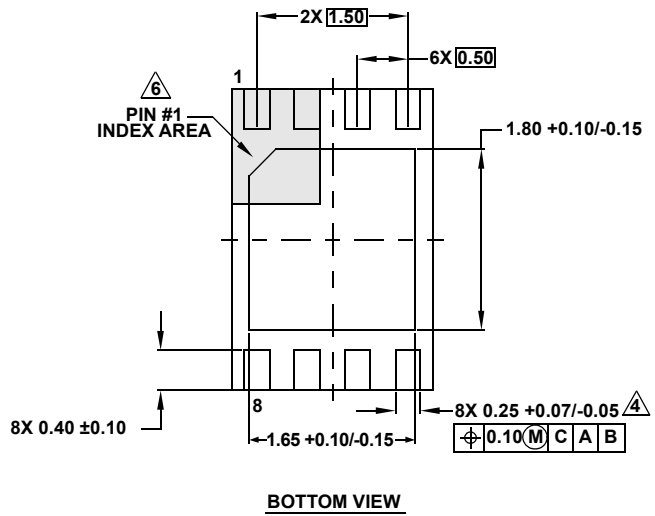
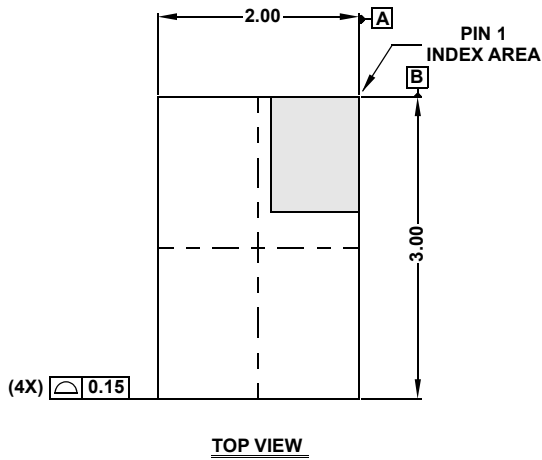

**NOTES:**

1. Dimensions are in millimeters.  
Dimensions in ( ) for Reference Only.
2. Dimensioning and tolerancing conform to ASME Y14.5m-1994.
3. Unless otherwise specified, tolerance: Decimal  $\pm 0.05$
4. Dimension applies to the metallized terminal and is measured between 0.25mm and 0.30mm from the terminal tip.
5. Tiebar shown (if present) is a non-functional feature and may be located on any of the 4 sides (or ends).
6. The configuration of the pin #1 identifier is optional, but must be located within the zone indicated. The pin #1 identifier may be either a mold or mark feature.
7. Complies to JEDEC MO-229 VCED-2.

## 8. Ordering Information

Part Number <sup>[1]</sup>	Part Marking	Default V <sub>OUT</sub> (V)	I <sup>2</sup> C Address	Package Description <sup>[2]</sup> (RoHS Compliant)	Pkg. Dwg. #	Carrier Type <sup>[3]</sup>	Temp Range
ISL9122AIINZ-T <sup>[4]</sup>	122A	3.3	0x18	8 Bump WLCSP	W2x4.8	Reel, 3k	-40 to +85°C
ISL9122AIINZ-T7A <sup>[4]</sup>						Reel, 250	
ISL9122AIRNZ-T <sup>[5]</sup>	A22	3.3		8 Ld DFN	L8.2x3	Reel, 6k	
ISL9122AIRNZ-T7A <sup>[5]</sup>						Reel, 250	
ISL9122AIIN-EVZ	Evaluation Board for ISL9122AIINZ						
ISL9122AIRN-EVZ	Evaluation Board for ISL9122AIRNZ						

1. For Moisture Sensitivity Level (MSL), see the [ISL9122A](#) device page. For more information on MSL, see [TB363](#).
2. For the Pb-Free Reflow Profile, see [TB493](#).
3. See [TB347](#) for details about reel specifications.
4. These Pb-free WLCSP packaged products employ special Pb-free material sets; molding compounds/die attach materials and SnAgCu - e1 solder ball terminals, which are RoHS compliant and compatible with both SnPb and Pb-free soldering operations. Pb-free WLCSP packaged products are MSL classified at Pb-free peak reflow temperatures that meet or exceed the Pb-free requirements of IPC/JEDEC J-STD-020.
5. These Pb-free plastic packaged products employ special Pb-free material sets, molding compounds/die attach materials, and 100% matte tin plate plus anneal (e3 termination finish, which is RoHS compliant and compatible with both SnPb and Pb-free soldering operations). Pb-free products are MSL classified at Pb-free peak reflow temperatures that meet or exceed the Pb-free requirements of IPC/JEDEC J-STD-020.

## 9. Revision History

Revision	Date	Description
1.02	Oct 27, 2023	<p>Applied the latest template and formatting.</p> <p>Updated the block diagram.</p> <p>Updated the Recommended Operating Conditions section.</p> <p>Updated Enable Input, Start-up, and PFM Operation sections.</p> <p>Updated I2C Serial Interface, Protocol Conventions, and Read Operation sections.</p> <p>Updated boost mode descriptions</p> <p>Updated FAMILY_ID to 0x1 and HW_REV value to 0x4 (in reg0x2).</p> <p>Updated INTFLG_REG section.</p>
1.01	Mar 17, 2022	<p>Updated page 1 description.</p> <p>Removed Related Literature section.</p> <p>Updated Features bullets.</p> <p>Updated the figure titles for Figure 1 and Figure 2.</p> <p>Updated Ordering Information table by updating formatting.</p> <p>Added Abs max for LX1, LX2 (less than 10ns).</p> <p>Added three more rows to the recommend operating conditions table.</p> <p>Updated Conditions in the Analog Specifications header.</p> <p>Updated Test Conditions for several parameters in the Analog Specification table.</p> <p>Updated the Peak Current Limit (<math>1.8V &lt; V_{IN} &lt; 2.5V</math>) specification typical value from 2.5A to <math>2.5 \cdot (V_{IN}/2.5)</math>.</p> <p>Updated the typical values for the Power MOSFET On-Resistance.</p> <p>Updated the following sections:</p> <p>Typical Performance Graphs, Line/Load Transient Waveforms, Enable Input, Soft Discharge, Start-Up, Overcurrent/Short-Circuit Protection, Thermal Shutdown, Buck-Boost Conversion Topology, Pulse Width Modulation (PWM) Operation, Pulse Frequency Modulation (PFM) Operation, Operation With VIN Close to VOUT, Forced Operating Modes, I2C Serial Interface, Protocol Conventions, Write Operation, Read Operation, and Register Descriptions</p> <p>Updated links throughout.</p> <p>Updated Pin descriptions for SDA and SCL.</p>
1.00	Sep 14, 2020	Initial release

## IMPORTANT NOTICE AND DISCLAIMER

RENESAS ELECTRONICS CORPORATION AND ITS SUBSIDIARIES (“RENESAS”) PROVIDES TECHNICAL SPECIFICATIONS AND RELIABILITY DATA (INCLUDING DATASHEETS), DESIGN RESOURCES (INCLUDING REFERENCE DESIGNS), APPLICATION OR OTHER DESIGN ADVICE, WEB TOOLS, SAFETY INFORMATION, AND OTHER RESOURCES “AS IS” AND WITH ALL FAULTS, AND DISCLAIMS ALL WARRANTIES, EXPRESS OR IMPLIED, INCLUDING, WITHOUT LIMITATION, ANY IMPLIED WARRANTIES OF MERCHANTABILITY, FITNESS FOR A PARTICULAR PURPOSE, OR NON-INFRINGEMENT OF THIRD PARTY INTELLECTUAL PROPERTY RIGHTS.

These resources are intended for developers skilled in the art designing with Renesas products. You are solely responsible for (1) selecting the appropriate products for your application, (2) designing, validating, and testing your application, and (3) ensuring your application meets applicable standards, and any other safety, security, or other requirements. These resources are subject to change without notice. Renesas grants you permission to use these resources only for development of an application that uses Renesas products. Other reproduction or use of these resources is strictly prohibited. No license is granted to any other Renesas intellectual property or to any third party intellectual property. Renesas disclaims responsibility for, and you will fully indemnify Renesas and its representatives against, any claims, damages, costs, losses, or liabilities arising out of your use of these resources. Renesas' products are provided only subject to Renesas' Terms and Conditions of Sale or other applicable terms agreed to in writing. No use of any Renesas resources expands or otherwise alters any applicable warranties or warranty disclaimers for these products.

(Disclaimer Rev.1.0 Mar 2020)

### Corporate Headquarters

TOYOSU FORESIA, 3-2-24 Toyosu,  
Koto-ku, Tokyo 135-0061, Japan  
[www.renesas.com](http://www.renesas.com)

### Contact Information

For further information on a product, technology, the most up-to-date version of a document, or your nearest sales office, please visit:  
[www.renesas.com/contact/](http://www.renesas.com/contact/)

### Trademarks



Renesas and the Renesas logo are trademarks of Renesas Electronics Corporation. All trademarks and registered trademarks are the property of their respective owners.

## Looking for pricing, stock, or lifecycle information?

Click below to explore more details on WIN SOURCE:

-  [View ISL9122AIRNZ-T on WIN SOURCE](#)
-  [Renesas Electronics America Information](#)

## Optimize Your Supply Chain with WIN SOURCE Solutions

-  Global Sourcing Solution
-  Obsolete Management
-  Cost Control Management
-  Shortage Management
-  Alternative Solution
-  Excess Inventory Management