



**THE DATASHEET OF  
NCV8163ASN300T1G**



# LDO Regulator - Ultra-Low Noise, High PSRR, RF and Analog Circuits

250 mA

## NCV8163

The NCV8163 is a next generation of high PSRR, ultra-low noise LDO capable of supplying 250 mA output current. Designed to meet the requirements of RF and sensitive analog circuits, the NCV8163 device provides ultra-low noise, high PSRR and low quiescent current. The device also offer excellent load/line transients. The NCV8163 is designed to work with a 1  $\mu$ F input and a 1  $\mu$ F output ceramic capacitor. It is available in XDFN4 0.65P, 1 mm x 1 mm and TSOP-5 packages.

### Features

- Operating Input Voltage Range: 2.2 V to 5.5 V
- Available in Fixed Voltage Option: 1.2 V to 5.3 V
- $\pm 2\%$  Accuracy Over Load/Temperature
- Ultra Low Quiescent Current Typ. 12  $\mu$ A
- Standby Current: Typ. 0.1  $\mu$ A
- Very Low Dropout: 80 mV at 250 mA @ 3.3 V
- Ultra High PSRR: Typ. 92 dB at 20 mA, f = 1 kHz
- Ultra Low Noise: 6.5  $\mu$ V<sub>RMS</sub>
- Stable with a 1  $\mu$ F Small Case Size Ceramic Capacitors
- Available in XDFN4 1 mm x 1 mm x 0.4 mm and TSOP-5 Packages
- NCV Prefix for Automotive and Other Applications Requiring Unique Site and Control Change Requirements; Grade 1 AEC-Q100 Qualified and PPAP Capable
- These Devices are Pb-Free, Halogen Free/BFR Free and are RoHS Compliant

### Typical Applications

- ADAS, Infotainment & Cluster, and Telematics
- General Purpose Automotive & Industrial
- Building & Factory Automation, Smart Meters

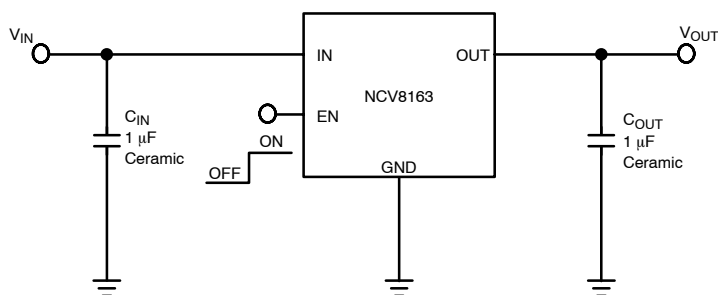
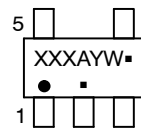

Figure 1. Typical Application Schematics



TSOP-5  
CASE 483

### MARKING DIAGRAMS



XXX = Specific Device Code  
A = Assembly Location  
Y = Year  
W = Work Week  
▪ = Pb-Free Package

(Note: Microdot may be in either location)



XDFN4  
CASE 711AJ

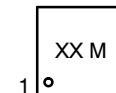

XX = Specific Device Code  
M = Date Code

### PIN CONNECTIONS

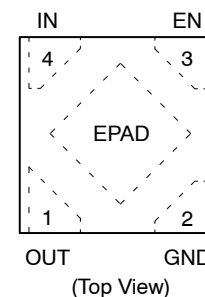
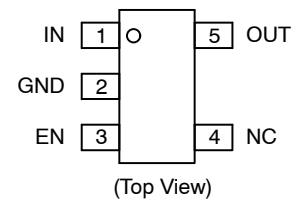

### ORDERING INFORMATION

See detailed ordering, marking and shipping information on page 14 of this data sheet.

# NCV8163

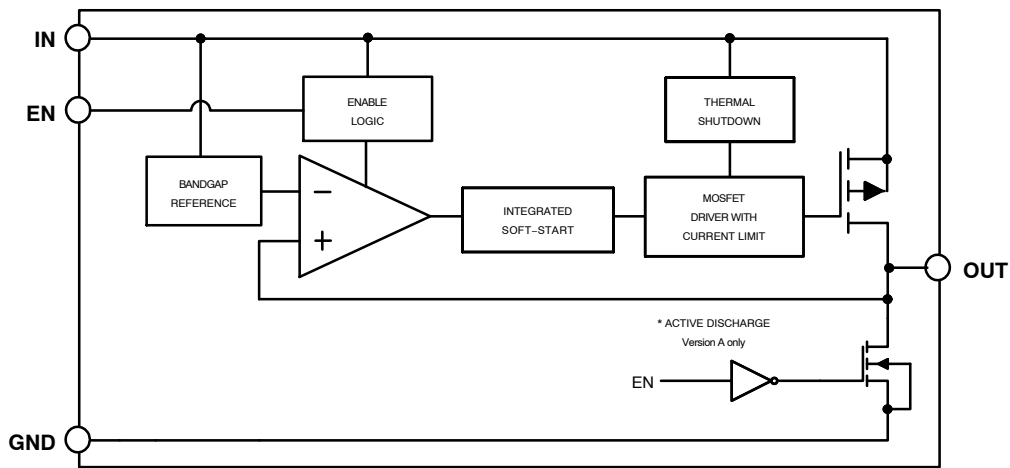

Figure 2. Simplified Schematic Block Diagram

## PIN FUNCTION DESCRIPTION

Pin No. TSOP-5	Pin No. XDFN4	Pin Name	Description
1	4	IN	Input voltage supply pin
5	1	OUT	Regulated output voltage. The output should be bypassed with small 1 $\mu$ F ceramic capacitor.
3	3	EN	Chip enable: Applying $V_{EN} < 0.4$ V disables the regulator, Pulling $V_{EN} > 1.2$ V enables the LDO.
2	2	GND	Common ground connection
4	-	N/C	Not connected. This pin can be tied to ground to improve thermal dissipation.
-	EP	EPAD	Exposed Pad. Exposed pad can be tied to ground plane for better power dissipation.

## ABSOLUTE MAXIMUM RATINGS

Rating	Symbol	Value	Unit
Input Voltage (Note 1)	$V_{IN}$	-0.3 V to 6	V
Output Voltage	$V_{OUT}$	-0.3 to $V_{IN} + 0.3$ , max. 6 V	V
Chip Enable Input	$V_{CE}$	-0.3 to 6 V	V
Output Short Circuit Duration	$t_{SC}$	unlimited	s
Operating Ambient Temperature Range	$T_A$	-40 to +125	$^{\circ}$ C
Maximum Junction Temperature	$T_J$	150	$^{\circ}$ C
Storage Temperature Range	$T_{STG}$	-55 to +150	$^{\circ}$ C
ESD Capability, Human Body Model (Note 2)	$ESD_{HBM}$	2000	V
ESD Capability, Machine Model (Note 2)	$ESD_{MM}$	200	V
ESD Capability, Charged Device Model (Note 2)	$ESD_{CDM}$	1000	V

Stresses exceeding those listed in the Maximum Ratings table may damage the device. If any of these limits are exceeded, device functionality should not be assumed, damage may occur and reliability may be affected.

1. Refer to ELECTRICAL CHARACTERISTICS and APPLICATION INFORMATION for Safe Operating Area.
2. This device series incorporates ESD protection and is tested by the following methods:
  - ESD Human Body Model tested per EIA/JESD22-A114
  - ESD Machine Model tested per EIA/JESD22-A115
  - ESD Charged Device Model tested per EIA/JESD22-C101, Field Induced Charge Model
  - Latchup Current Maximum Rating tested per JEDEC standard: JESD78.

## RECOMMENDED OPERATING CONDITIONS

Rating	Symbol	Min	Max	Unit
Input Voltage	$V_{IN}$	2.2	5.5	V
Junction Temperature	$T_J$	-40	+125	$^{\circ}$ C

Functional operation above the stresses listed in the Recommended Operating Ranges is not implied. Extended exposure to stresses beyond the Recommended Operating Ranges limits may affect device reliability.

**THERMAL CHARACTERISTICS**

Rating	Symbol	Value	Unit
Thermal Characteristics, XDFN4 (Note 3), Thermal Resistance, Junction-to-Air	$R_{\theta JA}$	198.1	$^{\circ}C/W$
Thermal Characteristics, TSOP-5 (Note 3), Thermal Resistance, Junction-to-Air	$R_{\theta JA}$	218	$^{\circ}C/W$

3. Measured according to JEDEC board specification. Detailed description of the board can be found in JESD51-7

**ELECTRICAL CHARACTERISTICS**  $-40^{\circ}C \leq T_J \leq 125^{\circ}C$ ;  $V_{IN} = V_{OUT(NOM)} + 1 V$ ;  $I_{OUT} = 1 mA$ ,  $C_{IN} = C_{OUT} = 1 \mu F$ , unless otherwise noted.  $V_{EN} = 1.2 V$ . Typical values are at  $T_J = +25^{\circ}C$  (Note 4).

Parameter	Test Conditions	Symbol	Min	Typ	Max	Unit	
Operating Input Voltage		$V_{IN}$	2.2		5.5	V	
Output Voltage Accuracy	$V_{IN} = (V_{OUT(NOM)} + 1 V) \text{ to } 5.5 V$	$V_{OUT}$	-2		+2	%	
	$V_{IN} = (V_{OUT(NOM)} + 1 V) \text{ to } 5.5 V$ (for $V_{OUT} < 1.8 V$ )	$V_{OUT}$	-3		+3	%	
Line Regulation	$V_{OUT(NOM)} + 1 V \leq V_{IN} \leq 5.5 V$	$Line_{Reg}$		0.02		%/V	
Load Regulation	$I_{OUT} = 1 mA \text{ to } 250 mA$	XDFN4	$Load_{Reg}$		0.001	0.005	%/mA
		TSOP-5			0.008	0.015	
Dropout Voltage (Note 5)	$I_{OUT} = 250 mA$ XDFN4 package	$V_{OUT(NOM)} = 1.8 V$	$V_{DO}$		180	250	mV
		$V_{OUT(NOM)} = 2.8 V$			95	160	
		$V_{OUT(NOM)} = 3.0 V$			90	155	
		$V_{OUT(NOM)} = 3.3 V$			80	145	
Dropout Voltage (Note 5)	$I_{OUT} = 250 mA$ TSOP-5 package	$V_{OUT(NOM)} = 1.8 V$	$V_{DO}$		205	280	mV
		$V_{OUT(NOM)} = 2.8 V$			120	190	
		$V_{OUT(NOM)} = 3.0 V$			115	185	
		$V_{OUT(NOM)} = 3.3 V$			105	175	
Output Current Limit	$V_{OUT} = 90\% V_{OUT(NOM)}$	$I_{CL}$	250	700		mA	
Short Circuit Current	$V_{OUT} = 0 V$	$I_{SC}$		690			
Quiescent Current	$I_{OUT} = 0 mA$	$I_Q$		12	20	$\mu A$	
Shutdown Current	$V_{EN} \leq 0.4 V, V_{IN} = 4.8 V$	$I_{DIS}$		0.01	1	$\mu A$	
EN Pin Threshold Voltage	EN Input Voltage "H"	$V_{ENH}$	1.2			V	
	EN Input Voltage "L"	$V_{ENL}$			0.4		
EN Pull Down Current	$V_{EN} = 4.8 V$	$I_{EN}$		0.2	0.5	$\mu A$	
Turn-On Time	$C_{OUT} = 1 \mu F$ , From assertion of $V_{EN}$ to $V_{OUT} = 95\% V_{OUT(NOM)}$			120		$\mu s$	
Power Supply Rejection Ratio	$I_{OUT} = 20 mA$	$f = 100 Hz$ $f = 1 kHz$ $f = 10 kHz$ $f = 100 kHz$	PSRR		91		dB
					92		
					85		
					60		
Output Voltage Noise	$f = 10 Hz \text{ to } 100 kHz$	$I_{OUT} = 1 mA$ $I_{OUT} = 250 mA$	$V_N$		8.0		$\mu V_{RMS}$
					6.5		
Thermal Shutdown Threshold	Temperature rising	$T_{SDH}$		160		$^{\circ}C$	
	Temperature falling	$T_{SDL}$		140		$^{\circ}C$	
Active Output Discharge Resistance	$V_{EN} < 0.4 V$ , Version A only	$R_{DIS}$		280		$\Omega$	
Line Transient (Note 6)	$V_{IN} = (V_{OUT(NOM)} + 1 V) \text{ to } (V_{OUT(NOM)} + 1.6 V)$ in $30 \mu s, I_{OUT} = 1 mA$	$Tran_{LINE}$		-1		mV	
					+1		
Load Transient (Note 6)	$I_{OUT} = 1 mA \text{ to } 200 mA$ in $10 \mu s$ $I_{OUT} = 200 mA \text{ to } 1 mA$ in $10 \mu s$	$Tran_{LOAD}$		-40		mV	
					+40		

Product parametric performance is indicated in the Electrical Characteristics for the listed test conditions, unless otherwise noted. Product performance may not be indicated by the Electrical Characteristics if operated under different conditions.

4. Performance guaranteed over the indicated operating temperature range by design and/or characterization. Production tested at  $T_A = 25^{\circ}C$ .

Low duty cycle pulse techniques are used during the testing to maintain the junction temperature as close to ambient as possible.

5. Dropout voltage is characterized when  $V_{OUT}$  falls 100 mV below  $V_{OUT(NOM)}$ .

6. Guaranteed by design.

TYPICAL CHARACTERISTICS

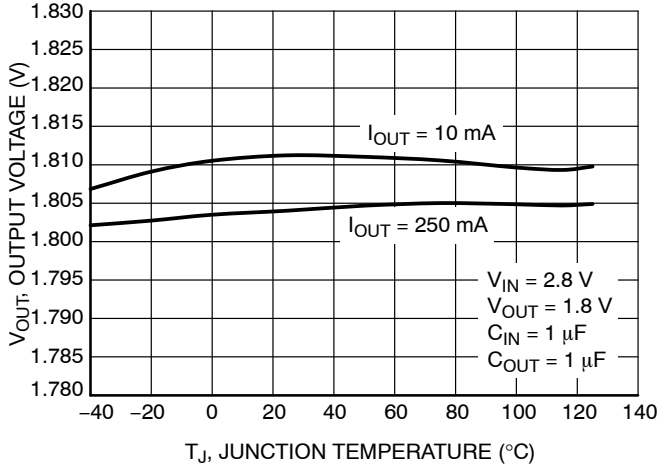

Figure 3. Output Voltage vs. Temperature –  $V_{OUT} = 1.8\text{ V}$  – XDFN Package

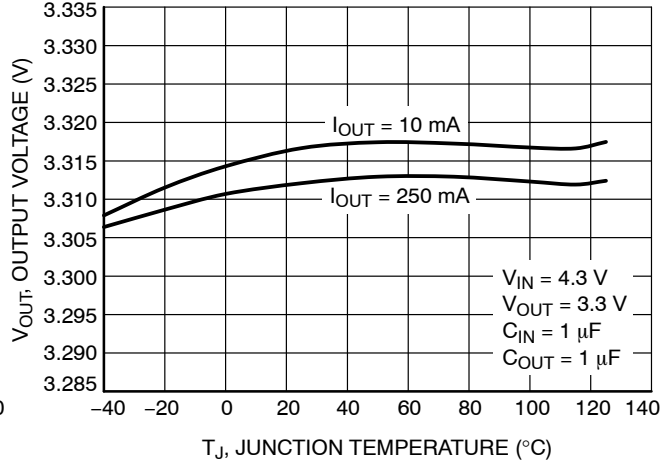

Figure 4. Output Voltage vs. Temperature –  $V_{OUT} = 3.3\text{ V}$  – XDFN Package

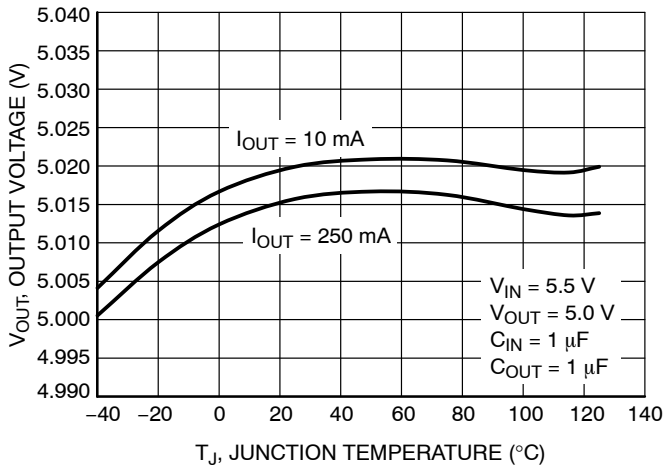

Figure 5. Output Voltage vs. Temperature –  $V_{OUT} = 5.0\text{ V}$  – XDFN Package

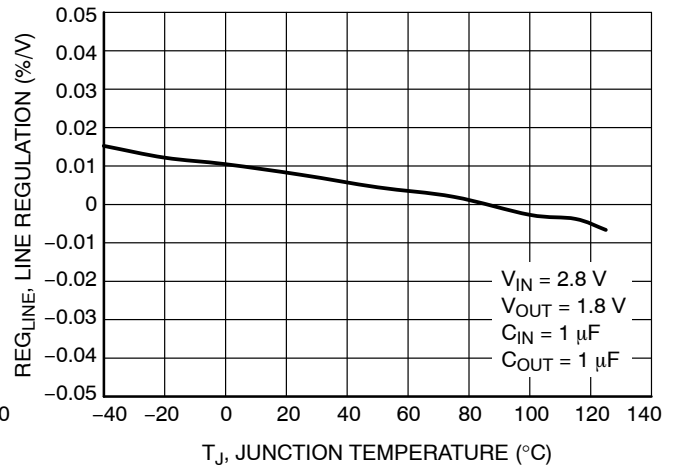

Figure 6. Line Regulation vs. Temperature –  $V_{OUT} = 1.8\text{ V}$

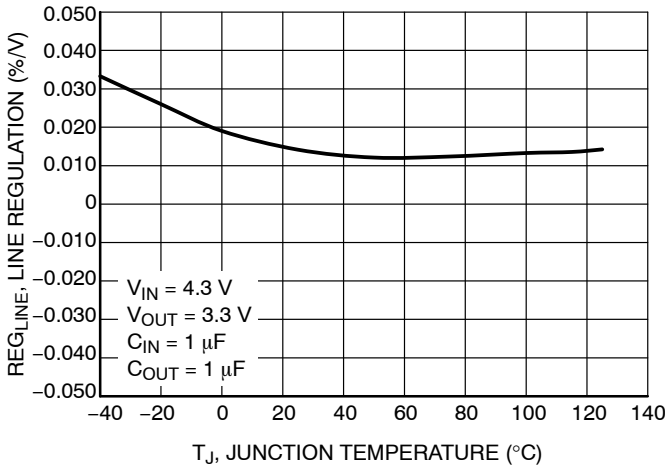

Figure 7. Line Regulation vs. Temperature –  $V_{OUT} = 3.3\text{ V}$

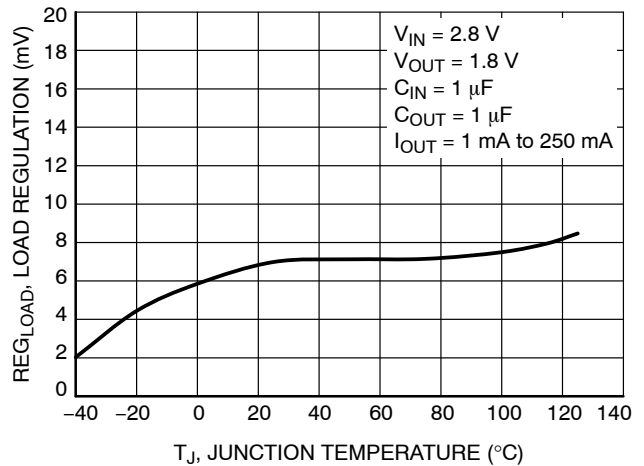

Figure 8. Load Regulation vs. Temperature –  $V_{OUT} = 1.8\text{ V}$

TYPICAL CHARACTERISTICS

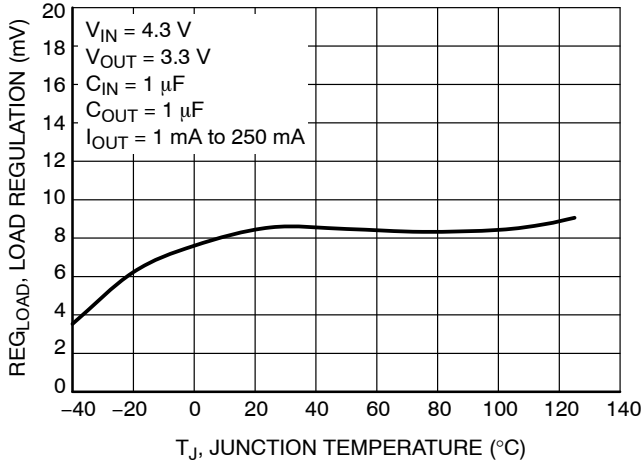

Figure 9. Load Regulation vs. Temperature -  $V_{OUT} = 3.3\text{ V}$

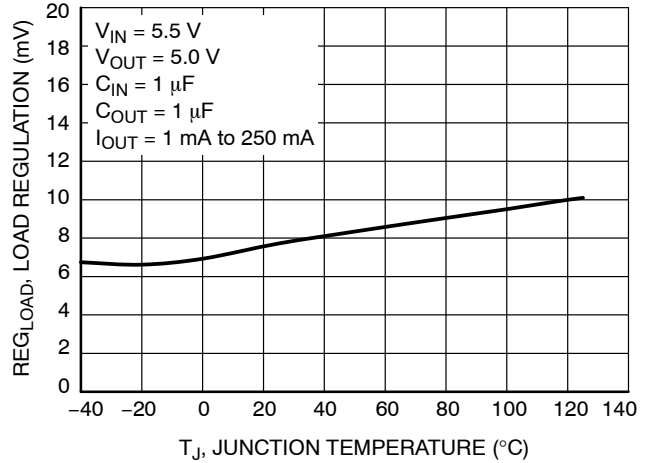

Figure 10. Load Regulation vs. Temperature -  $V_{OUT} = 5.0\text{ V}$

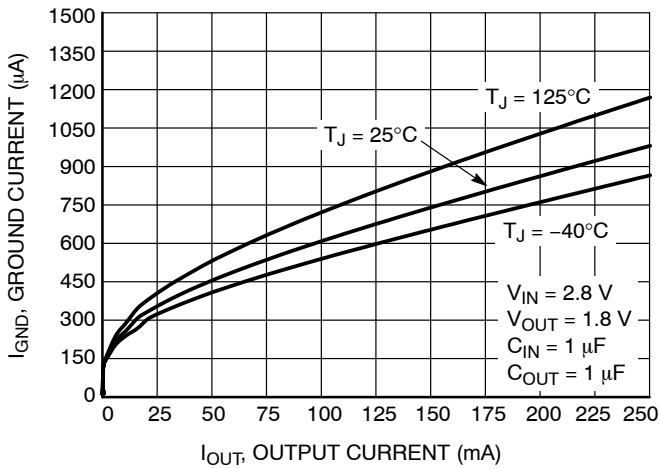

Figure 11. Ground Current vs. Load Current -  $V_{OUT} = 1.8\text{ V}$

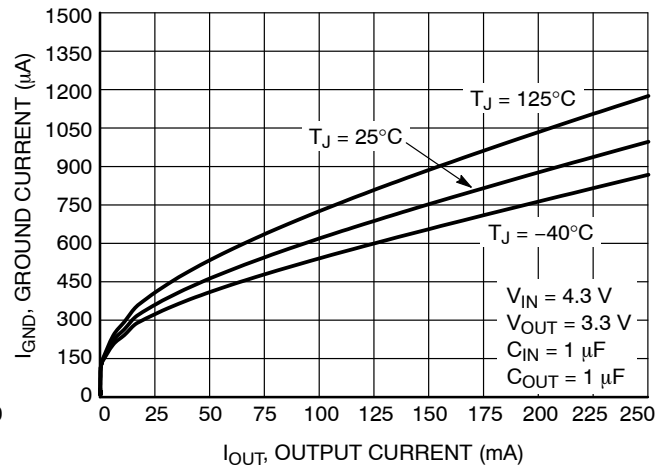

Figure 12. Ground Current vs. Load Current -  $V_{OUT} = 3.3\text{ V}$

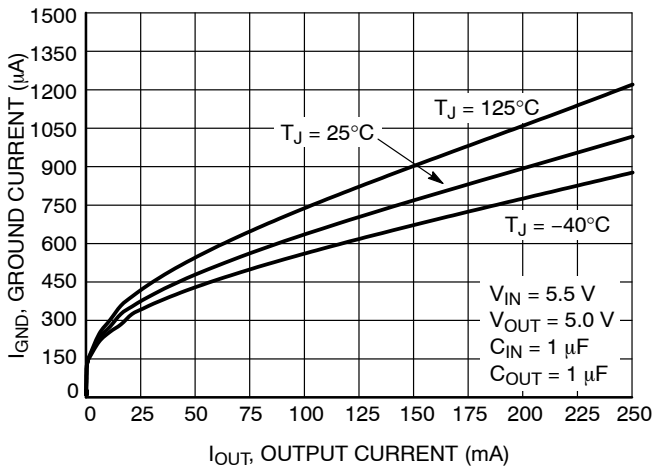

Figure 13. Ground Current vs. Load Current -  $V_{OUT} = 5.0\text{ V}$

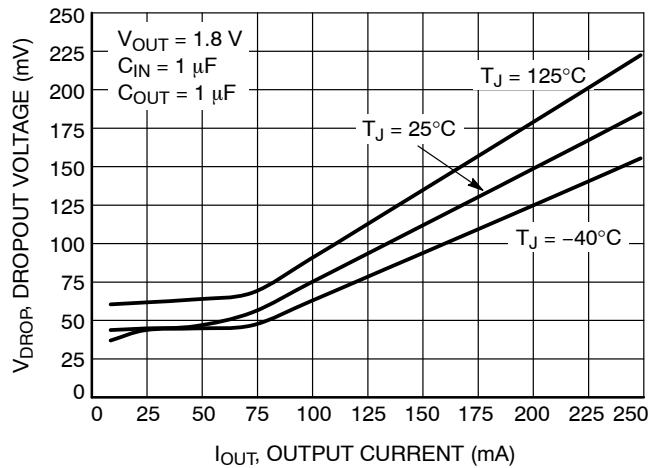

Figure 14. Dropout Voltage vs. Load Current -  $V_{OUT} = 1.8\text{ V}$  - XDFN4 Package

TYPICAL CHARACTERISTICS

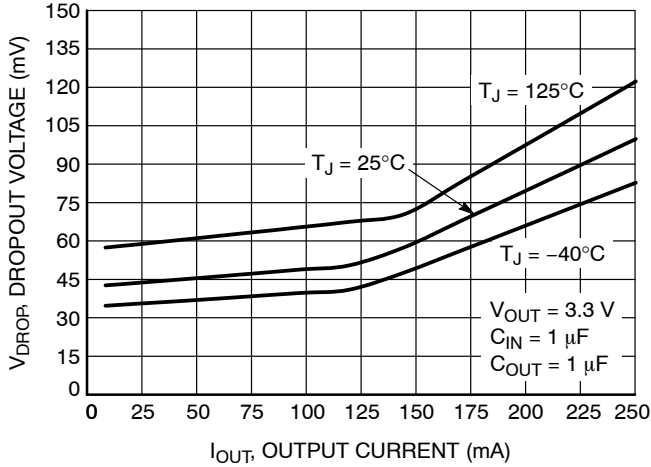

Figure 15. Dropout Voltage vs. Load Current –  $V_{OUT} = 3.3\text{ V}$  – XDFN4 Package

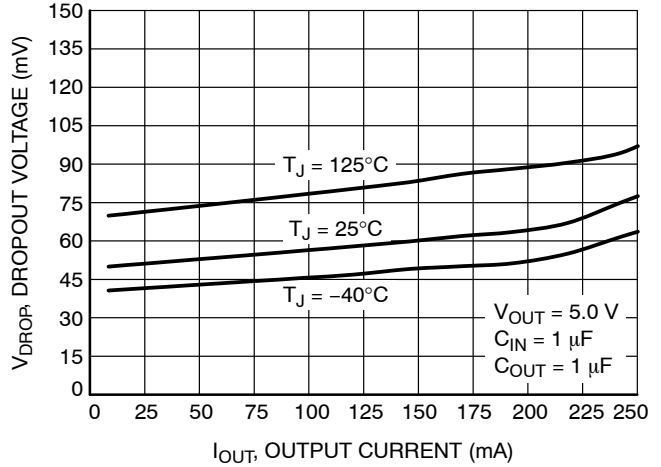

Figure 16. Dropout Voltage vs. Load Current –  $V_{OUT} = 5.0\text{ V}$  – XDFN4 Package

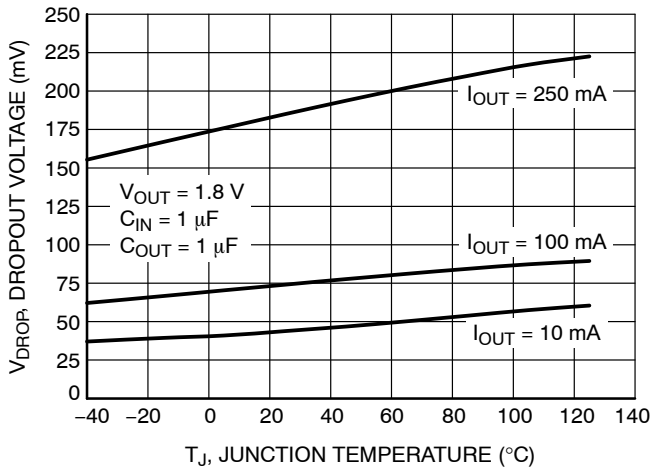

Figure 17. Dropout Voltage vs. Temperature –  $V_{OUT} = 1.8\text{ V}$  – XDFN4 Package

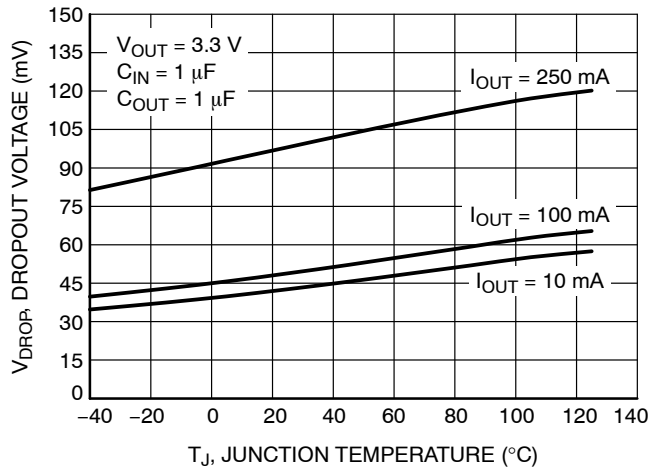

Figure 18. Dropout Voltage vs. Temperature –  $V_{OUT} = 3.3\text{ V}$  – XDFN4 Package

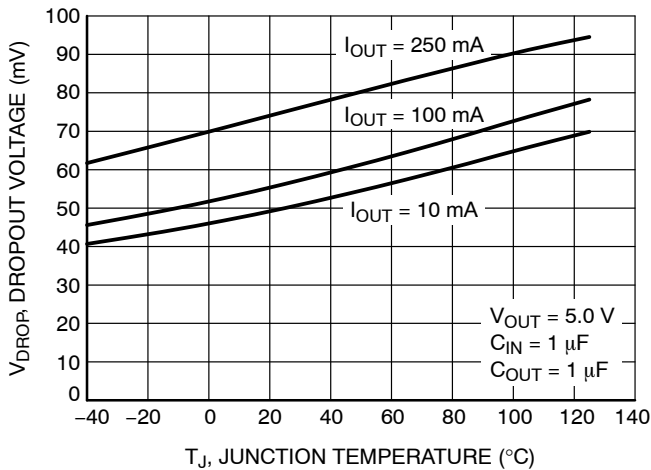

Figure 19. Dropout Voltage vs. Temperature –  $V_{OUT} = 5.0\text{ V}$  – XDFN4 Package

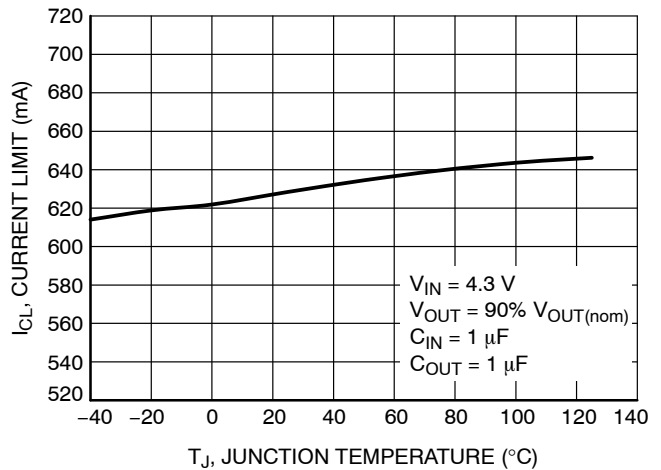

Figure 20. Current Limit vs. Temperature

TYPICAL CHARACTERISTICS

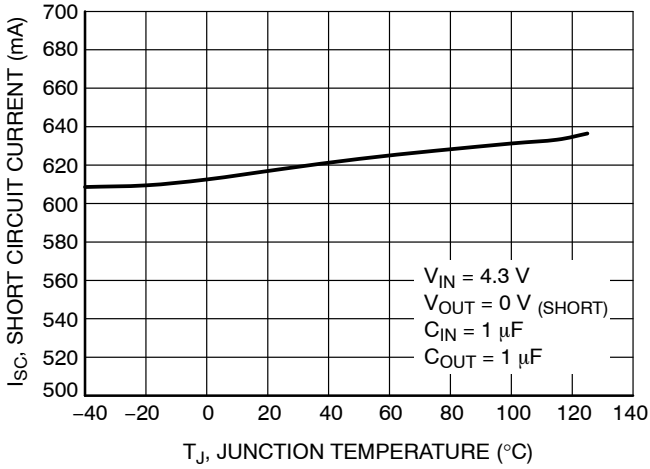

Figure 21. Short Circuit Current vs. Temperature

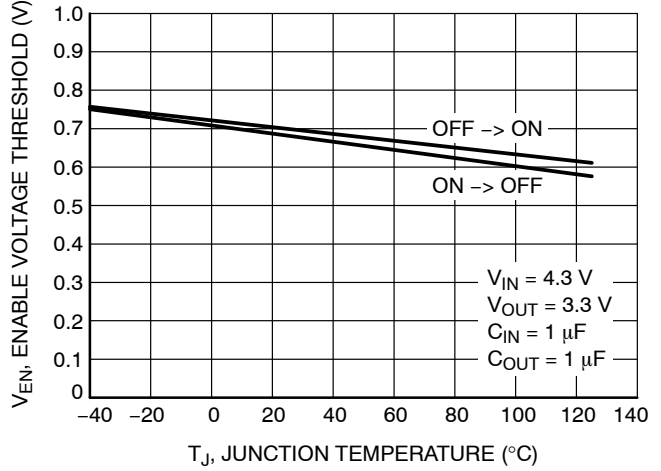

Figure 22. Enable Thresholds Voltage

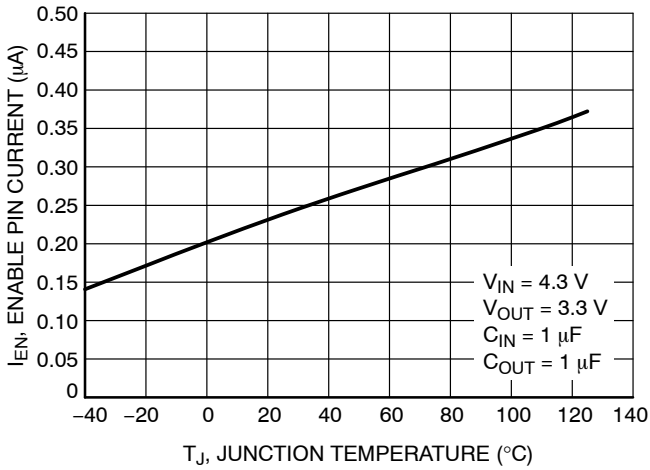

Figure 23. Current to Enable Pin vs. Temperature

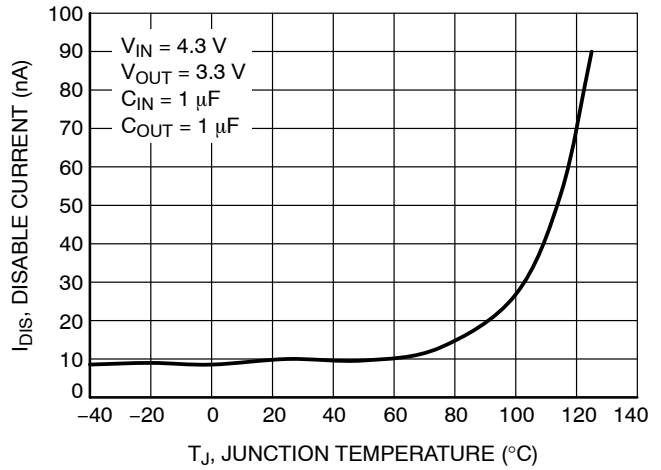

Figure 24. Disable Current vs. Temperature

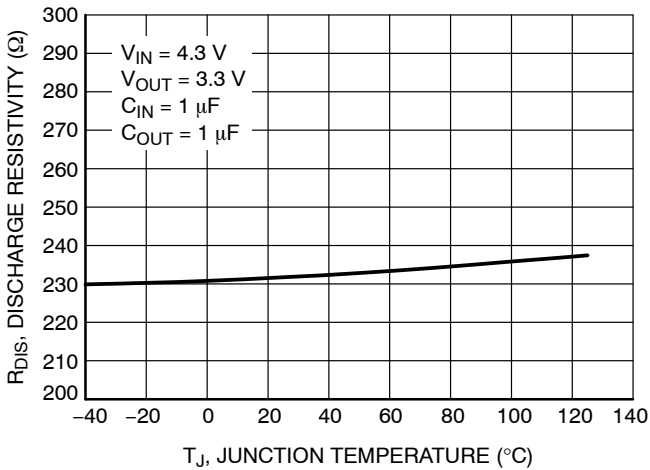

Figure 25. Discharge Resistance vs. Temperature

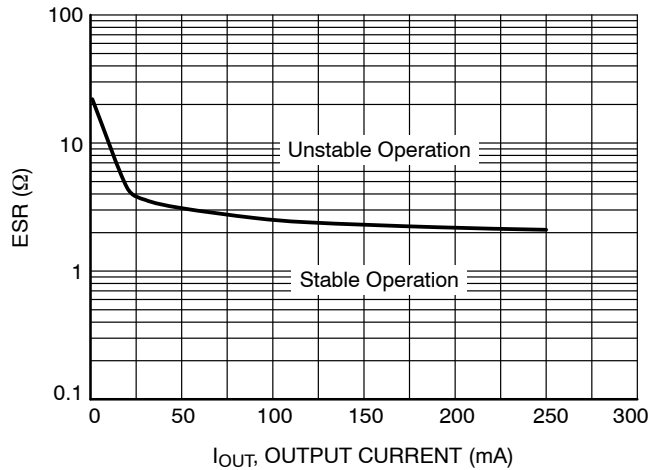
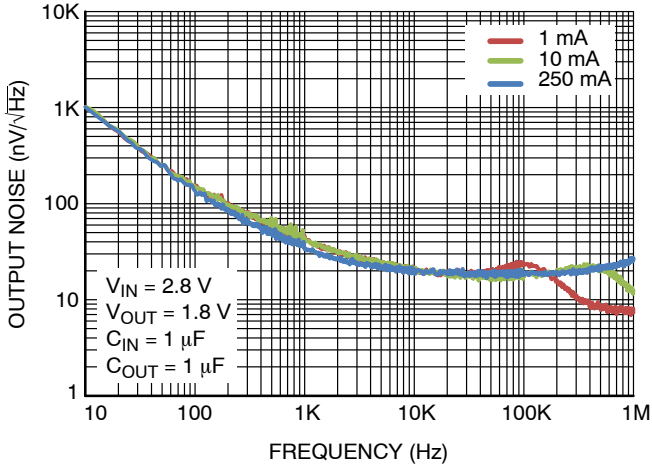

Figure 26. Maximum C<sub>OUT</sub> ESR Value vs. Load Current

TYPICAL CHARACTERISTICS



$I_{OUT}$	RMS Output Noise ( $\mu\text{V}$ )	
	10 Hz - 100 kHz	100 Hz - 100 kHz
1 mA	7.73	6.99
10 mA	7.12	6.26
250 mA	7.11	6.33

Figure 27. Output Voltage Noise Spectral Density –  $V_{OUT} = 1.8\text{ V}$

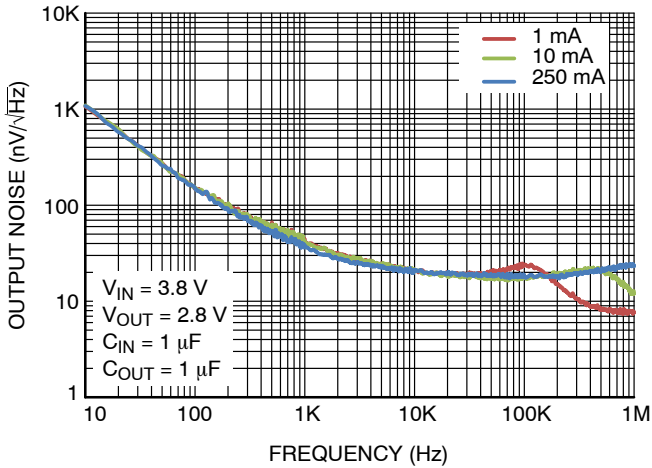

$I_{OUT}$	RMS Output Noise ( $\mu\text{V}$ )	
	10 Hz - 100 kHz	100 Hz - 100 kHz
1 mA	7.9	7.07
10 mA	7.19	6.25
250 mA	7.29	6.38

Figure 28. Output Voltage Noise Spectral Density –  $V_{OUT} = 2.8\text{ V}$

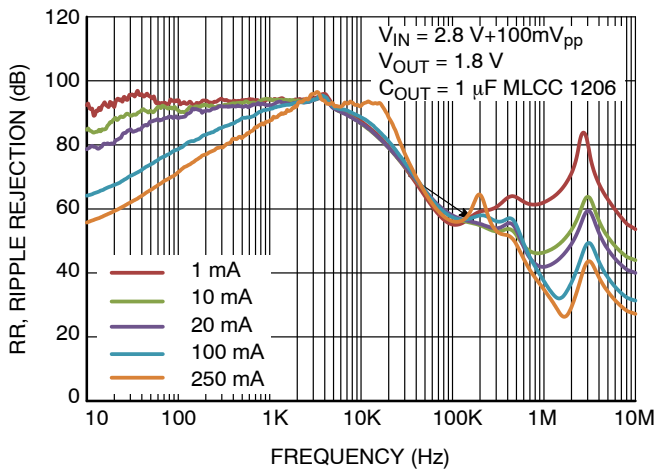

Figure 29. Power Supply Rejection Ratio –  $V_{OUT} = 1.8\text{ V}$

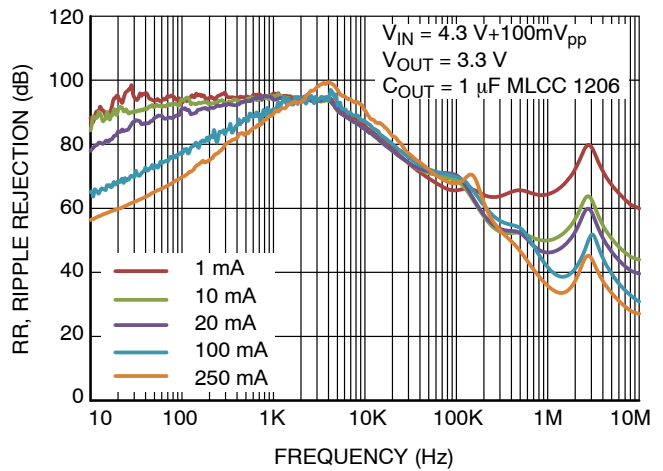

Figure 30. Power Supply Rejection Ratio –  $V_{OUT} = 3.3\text{ V}$

TYPICAL CHARACTERISTICS

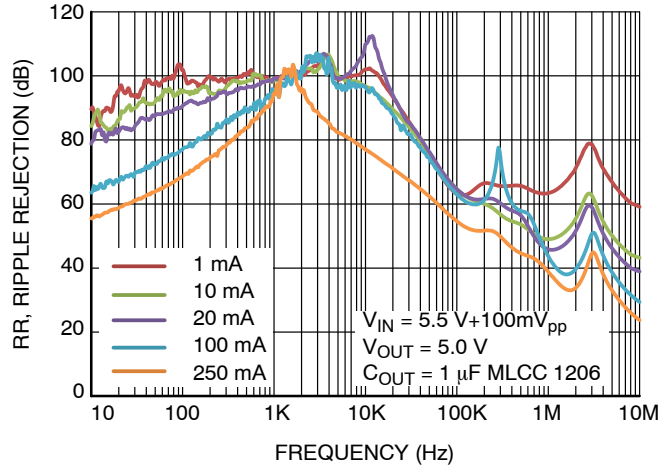

Figure 31. Power Supply Rejection Ratio –  $V_{OUT} = 5.0\text{ V}$

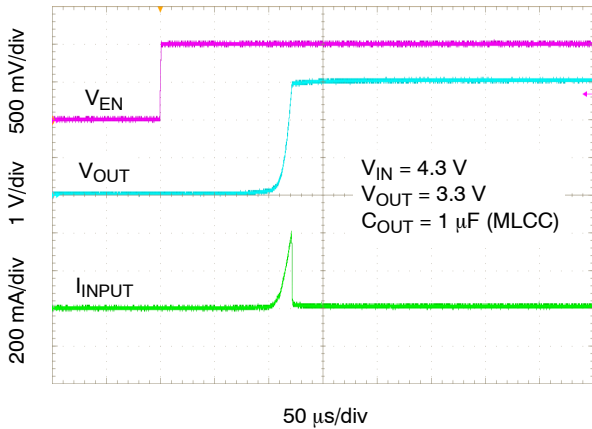

Figure 32. Enable Turn-on Response –  $C_{OUT} = 1\ \mu\text{F}$ ,  $I_{OUT} = 10\ \text{mA}$

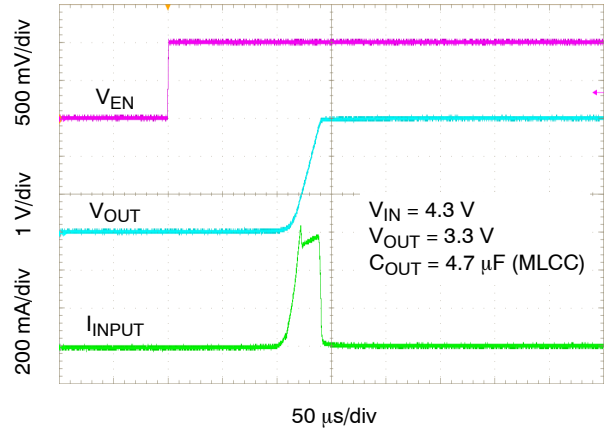

Figure 33. Enable Turn-on Response –  $C_{OUT} = 4.7\ \mu\text{F}$ ,  $I_{OUT} = 10\ \text{mA}$

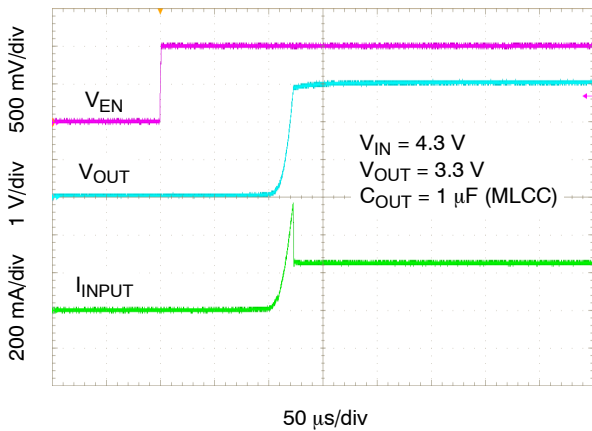

Figure 34. Enable Turn-on Response –  $C_{OUT} = 1\ \mu\text{F}$ ,  $I_{OUT} = 250\ \text{mA}$

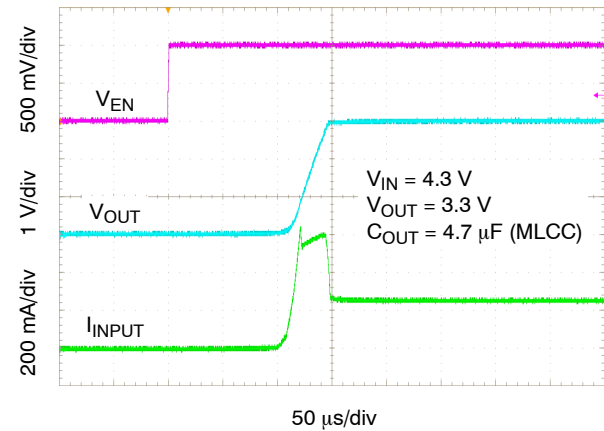

Figure 35. Enable Turn-on Response –  $C_{OUT} = 4.7\ \mu\text{F}$ ,  $I_{OUT} = 250\ \text{mA}$

TYPICAL CHARACTERISTICS

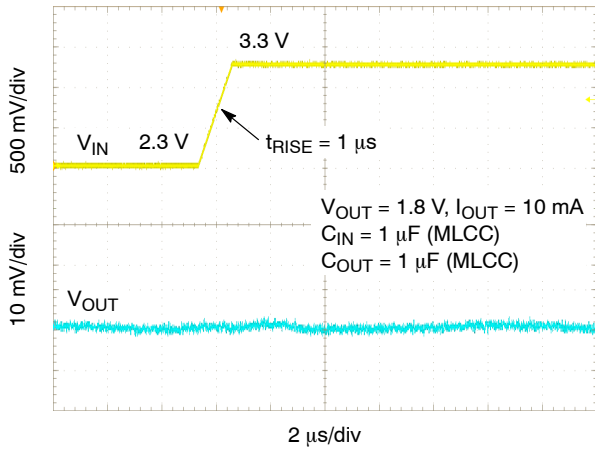

Figure 36. Line Transient Response –  $I_{OUT} = 10 \text{ mA}$

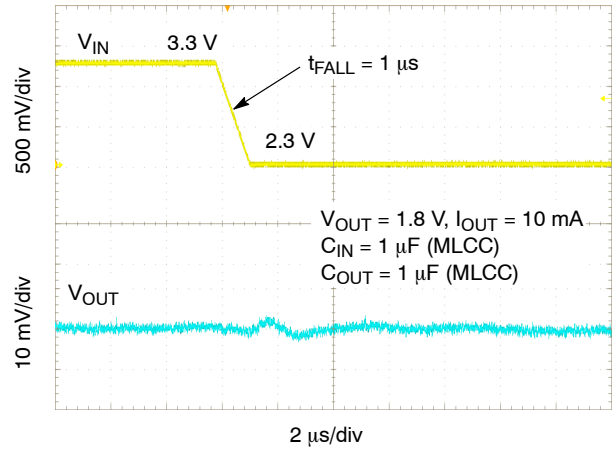

Figure 37. Line Transient Response –  $I_{OUT} = 10 \text{ mA}$

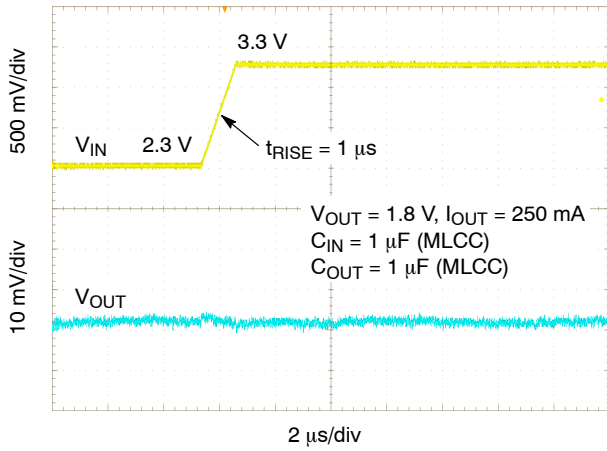

Figure 38. Line Transient Response –  $I_{OUT} = 250 \text{ mA}$

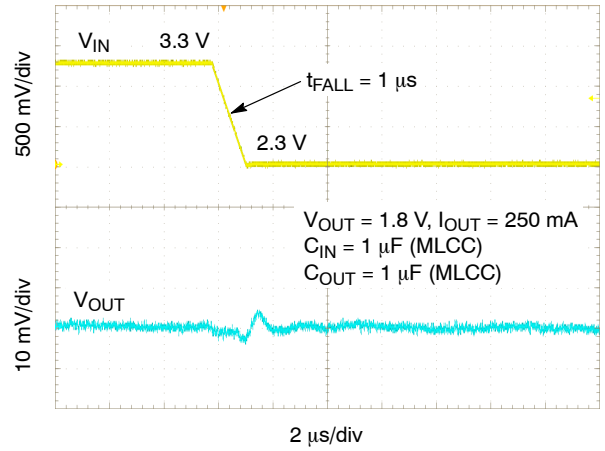

Figure 39. Line Transient Response –  $I_{OUT} = 250 \text{ mA}$

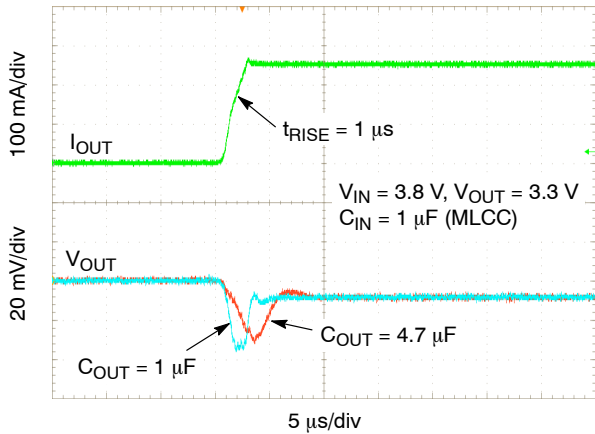

Figure 40. Load Transient Response –  $1 \text{ mA to } 250 \text{ mA}$

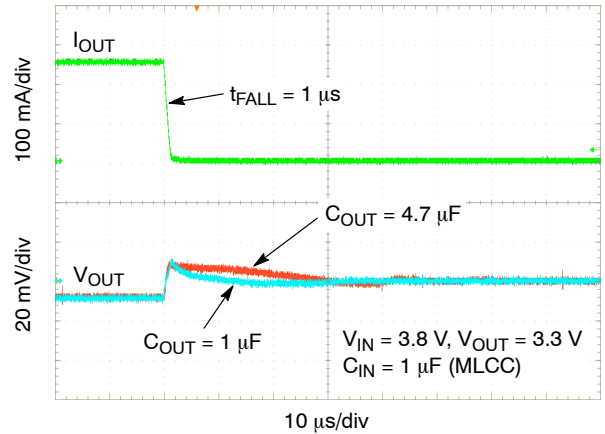

Figure 41. Load Transient Response –  $250 \text{ mA to } 1 \text{ mA}$

TYPICAL CHARACTERISTICS

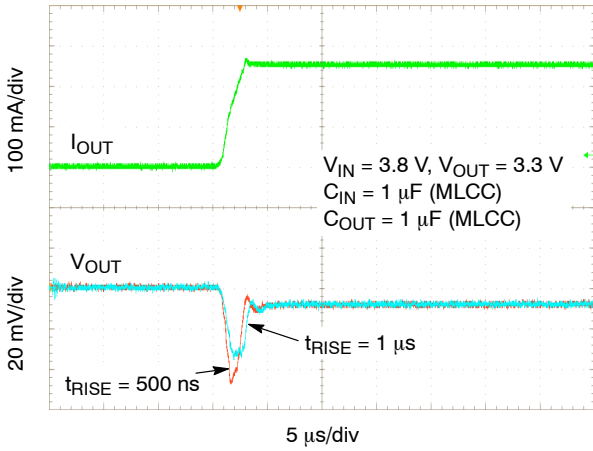

Figure 42. Load Transient Response – 1 mA to 250 mA

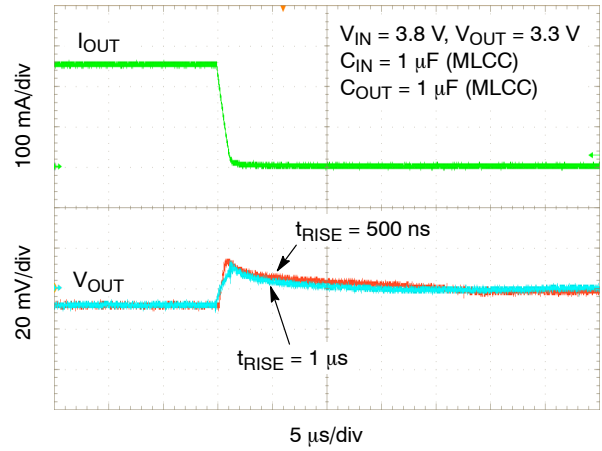

Figure 43. Load Transient Response – 250 mA to 1 mA

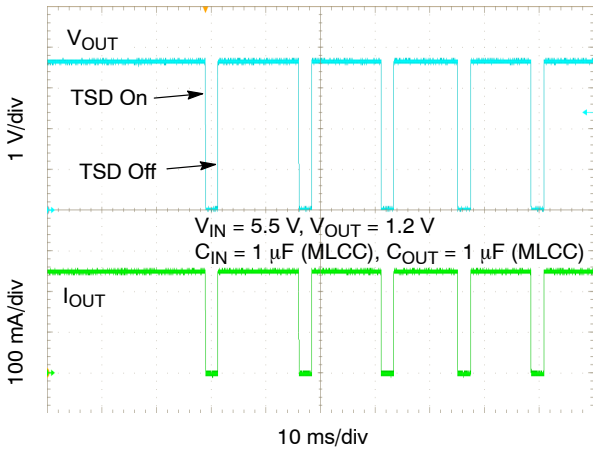

Figure 44. Overheating Protection – TSD

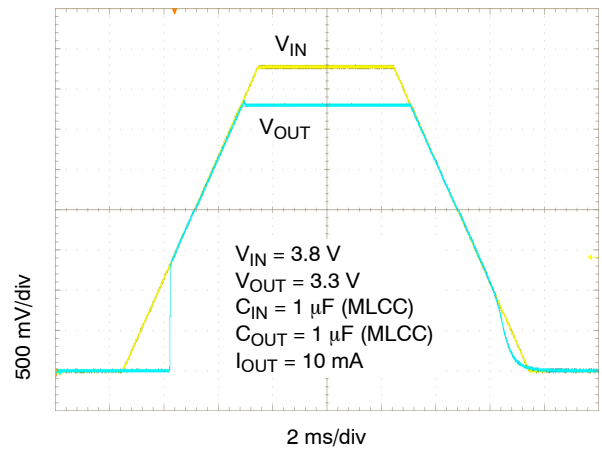

Figure 45. Turn-on/off – Slow Rising  $V_{IN}$

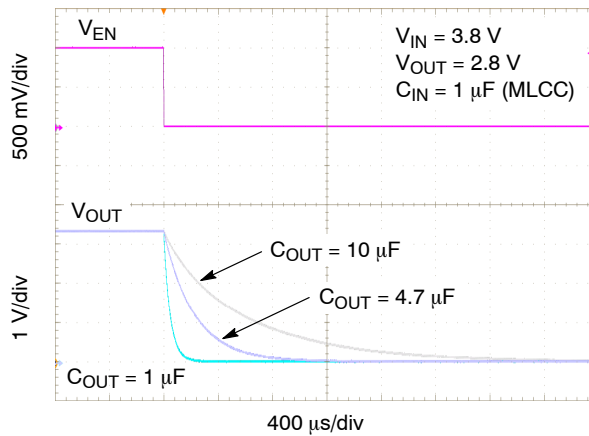

Figure 46. Enable Turn-off – Various Output Capacitors

APPLICATIONS INFORMATION

**General**

The NCV8163 is an ultra–low noise 250 mA low dropout regulator designed to meet the requirements of RF applications and high performance analog circuits. The NCV8163 device provides very high PSRR and excellent dynamic response. In connection with low quiescent current this device is well suitable for battery powered application such as cell phones, tablets and other. The NCV8163 is fully protected in case of current overload, output short circuit and overheating.

**Input Capacitor Selection (C<sub>IN</sub>)**

Input capacitor connected as close as possible is necessary for ensure device stability. The X7R or X5R capacitor should be used for reliable performance over temperature range. The value of the input capacitor should be 1 μF or greater to ensure the best dynamic performance. This capacitor will provide a low impedance path for unwanted AC signals or noise modulated onto constant input voltage. There is no requirement for the ESR of the input capacitor but it is recommended to use ceramic capacitors for their low ESR and ESL. A good input capacitor will limit the influence of input trace inductance and source resistance during sudden load current changes.

**Output Decoupling (C<sub>OUT</sub>)**

The NCV8163 requires an output capacitor connected as close as possible to the output pin of the regulator. The recommended capacitor value is 1 μF and X7R or X5R dielectric due to its low capacitance variations over the specified temperature range. The NCV8163 is designed to remain stable with minimum effective capacitance of 0.7 μF to account for changes with temperature, DC bias and package size. Especially for small package size capacitors such as 0201 the effective capacitance drops rapidly with the applied DC bias. Please refer Figure 47.

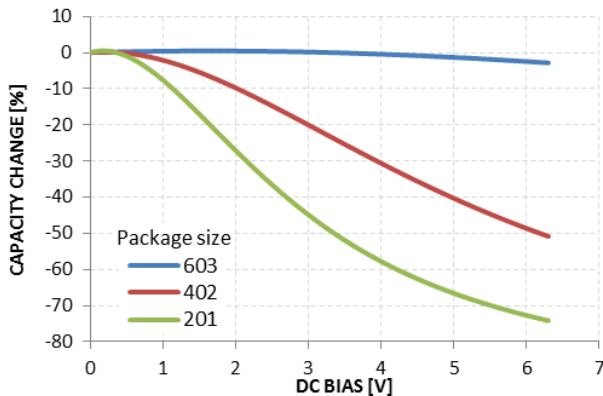

**Figure 47. Capacity vs DC Bias Voltage**

There is no requirement for the minimum value of Equivalent Series Resistance (ESR) for the C<sub>OUT</sub> but the maximum value of ESR should be less than 2 Ω. Larger output capacitors and lower ESR could improve the load

transient response or high frequency PSRR. It is not recommended to use tantalum capacitors on the output due to their large ESR. The equivalent series resistance of tantalum capacitors is also strongly dependent on the temperature, increasing at low temperature.

**Enable Operation**

The NCV8163 uses the EN pin to enable/disable its device and to deactivate/activate the active discharge function.

If the EN pin voltage is <0.4 V the device is guaranteed to be disabled. The pass transistor is turned–off so that there is virtually no current flow between the IN and OUT. The active discharge transistor is active so that the output voltage V<sub>OUT</sub> is pulled to GND through a 280 Ω resistor. In the disable state the device consumes as low as typ. 10 nA from the V<sub>IN</sub>.

If the EN pin voltage >1.2 V the device is guaranteed to be enabled. The NCV8163 regulates the output voltage and the active discharge transistor is turned–off.

The EN pin has internal pull–down current source with typ. value of 200 nA which assures that the device is turned–off when the EN pin is not connected. In the case where the EN function isn’t required the EN should be tied directly to IN.

**Output Current Limit**

Output Current is internally limited within the IC to a typical 700 mA. The NCV8163 will source this amount of current measured with a voltage drops on the 90% of the nominal V<sub>OUT</sub>. If the Output Voltage is directly shorted to ground (V<sub>OUT</sub> = 0 V), the short circuit protection will limit the output current to 690 mA (typ). The current limit and short circuit protection will work properly over whole temperature range and also input voltage range. There is no limitation for the short circuit duration.

**Thermal Shutdown**

When the die temperature exceeds the Thermal Shutdown threshold (T<sub>SD</sub> – 160°C typical), Thermal Shutdown event is detected and the device is disabled. The IC will remain in this state until the die temperature decreases below the Thermal Shutdown Reset threshold (T<sub>SDU</sub> – 140°C typical). Once the IC temperature falls below the 140°C the LDO is enabled again. The thermal shutdown feature provides the protection from a catastrophic device failure due to accidental overheating. This protection is not intended to be used as a substitute for proper heat sinking.

**Power Dissipation**

As power dissipated in the NCV8163 increases, it might become necessary to provide some thermal relief. The maximum power dissipation supported by the device is dependent upon board design and layout. Mounting pad configuration on the PCB, the board material, and the

# NCV8163

ambient temperature affect the rate of junction temperature rise for the part.

The maximum power dissipation the NCV8163 can handle is given by:

$$P_{D(MAX)} = \frac{[125^{\circ}\text{C} - T_A]}{\theta_{JA}} \quad (\text{eq. 1})$$

The power dissipated by the NCV8163 for given application conditions can be calculated from the following equations:

$$P_D \approx V_{IN} \cdot I_{GND} + I_{OUT}(V_{IN} - V_{OUT}) \quad (\text{eq. 2})$$

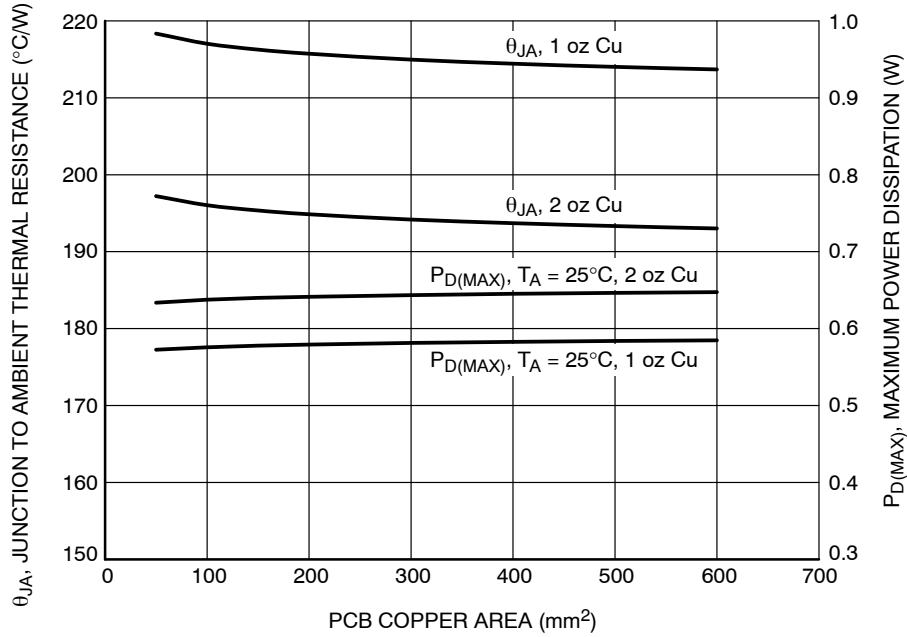

Figure 48.  $\theta_{JA}$  and  $P_{D(MAX)}$  vs. Copper Area – XDFN4

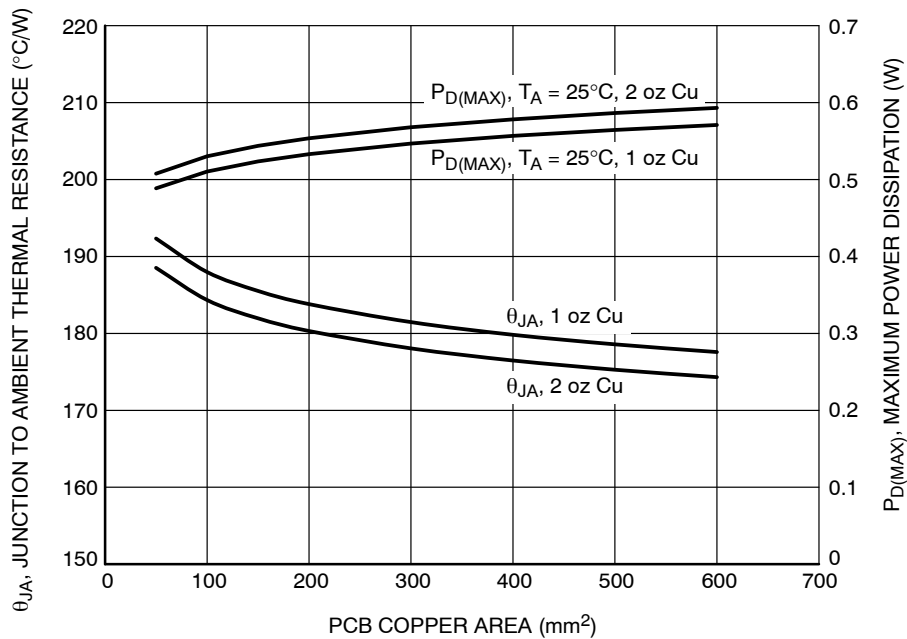

Figure 49.  $\theta_{JA}$  and  $P_{D(MAX)}$  vs. Copper Area – TSOP-5

## NCV8163

### Reverse Current

The PMOS pass transistor has an inherent body diode which will be forward biased in the case that  $V_{OUT} > V_{IN}$ . Due to this fact in cases, where the extended reverse current condition can be anticipated the device may require additional external protection.

### Power Supply Rejection Ratio

The NCV8163 features very high Power Supply Rejection ratio. If desired the PSRR at higher frequencies in the range 100 kHz – 10 MHz can be tuned by the selection of  $C_{OUT}$  capacitor and proper PCB layout.

### Turn-On Time

The turn-on time is defined as the time period from EN assertion to the point in which  $V_{OUT}$  will reach 98% of its nominal value. This time is dependent on various application conditions such as  $V_{OUT(NOM)}$ ,  $C_{OUT}$ ,  $T_A$ .

### PCB Layout Recommendations

To obtain good transient performance and good regulation characteristics place  $C_{IN}$  and  $C_{OUT}$  capacitors close to the device pins and make the PCB traces wide. In order to minimize the solution size, use 0402 or 0201 capacitors with appropriate capacity. Larger copper area connected to the pins will also improve the device thermal resistance. The actual power dissipation can be calculated from the equation above (Equation 2). Expose pad can be tied to the GND pin for improvement power dissipation and lower device temperature.

## ORDERING INFORMATION

Device	Voltage Option	Marking	Description	Package	Shipping†
NCV8163AMX120TBG (Note 7)	1.2 V	ME	250 mA, Active Discharge	XDFN4 CASE 711AJ (Pb-Free)	3000 or 5000 / Tape & Reel (Note 7)
NCV8163AMX150TBG (Note 7)	1.5 V	MV			
NCV8163AMX180TBG (Note 7)	1.8 V	MA			
NCV8163AMX250TBG (Note 7)	2.5 V	MU			
NCV8163AMX270TBG (Note 7)	2.7 V	MX			
NCV8163AMX280TBG (Note 7)	2.8 V	MM			
NCV8163AMX300TBG (Note 7)	3.0 V	MJ			
NCV8163AMX330TBG (Note 7)	3.3 V	MK			
NCV8163BMX280TBG	2.8 V	PE	250 mA, Non-Active Discharge	XDFN4 CASE 711AJ (Pb-Free)	3000 / Tape & Reel
NCV8163ASN120T1G	1.2 V	MKE	250 mA, Active Discharge	TSOP-5 CASE 483 (Pb-Free)	3000 / Tape & Reel
NCV8163ASN180T1G	1.8 V	KAA			
NCV8163ASN270T1G	2.7 V	KAK			
NCV8163ASN280T1G	2.8 V	KAE			
NCV8163ASN300T1G	3.0 V	KAF			
NCV8163ASN330T1G	3.3 V	KAG			
NCV8163ASN500T1G	5.0 V	KAJ			
NCV8163BSN180T1G	1.8 V	KAC	250 mA, Non-Active Discharge		

†For information on tape and reel specifications, including part orientation and tape sizes, please refer to our Tape and Reel Packaging Specifications Brochure, BRD8011/D.

7. Products processed after October 1, 2022 are shipped with quantity 5000 units / tape & reel.

# MECHANICAL CASE OUTLINE PACKAGE DIMENSIONS



## TSOP-5 3.00x1.50x0.95, 0.95P CASE 483 ISSUE P

DATE 01 APR 2024

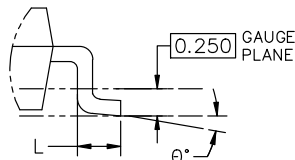
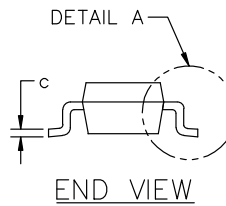

DETAIL "A"  
SCALE 2:1

### GENERIC MARKING DIAGRAM\*



- |                            |                            |
|----------------------------|----------------------------|
| XXX = Specific Device Code | XXX = Specific Device Code |
| A = Assembly Location      | M = Date Code              |
| Y = Year                   | ▪ = Pb-Free Package        |
| W = Work Week              |                            |
| ▪ = Pb-Free Package        |                            |

(Note: Microdot may be in either location)

\*This information is generic. Please refer to device data sheet for actual part marking. Pb-Free indicator, "G" or microdot "▪", may or may not be present. Some products may not follow the Generic Marking.

### NOTES:

- DIMENSIONING AND TOLERANCING CONFORM TO ASME Y14.5-2018.
- ALL DIMENSION ARE IN MILLIMETERS (ANGLES IN DEGREES).
- MAXIMUM LEAD THICKNESS INCLUDES LEAD FINISH THICKNESS. MINIMUM LEAD THICKNESS IS THE MINIMUM THICKNESS OF BASE MATERIAL.
- DIMENSIONS D AND E1 DO NOT INCLUDE MOLD FLASH, PROTRUSIONS OF GATE BURRS. MOLD FLASH, PROTRUSIONS, OR GATE BURRS SHALL NOT EXCEED 0.15 PER SIDE. DIMENSION D.
- OPTIONAL CONSTRUCTION: AN ADDITIONAL TRIMMED LEAD IS ALLOWED IN THIS LOCATION. TRIMMED LEAD NOT TO EXTEND MORE THAN 0.2 FROM BODY.

DIM	MILLIMETERS		
	MIN.	NOM.	MAX.
A	0.900	1.000	1.100
A1	0.010	0.055	0.100
A2	0.950 REF.		
b	0.250	0.375	0.500
c	0.100	0.180	0.260
D	2.850	3.000	3.150
E	2.500	2.750	3.000
E1	1.350	1.500	1.650
e	0.950 BSC		
L	0.200	0.400	0.600
θ	0°	5°	10°

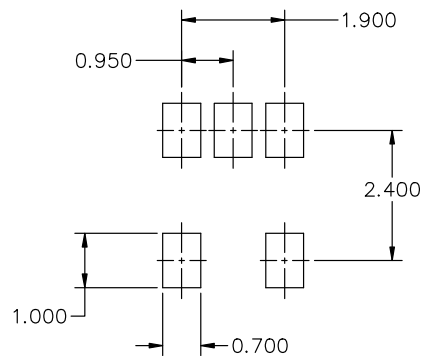

### RECOMMENDED MOUNTING FOOTPRINT\*

\* FOR ADDITIONAL INFORMATION ON OUR Pb-FREE STRATEGY AND SOLDERING DETAILS, PLEASE DOWNLOAD THE ON SEMICONDUCTOR SOLDERING AND MOUNTING TECHNIQUES REFERENCE MANUAL, SOLDERM/D.

<b>DOCUMENT NUMBER:</b>	<b>98ARB18753C</b>	Electronic versions are uncontrolled except when accessed directly from the Document Repository. Printed versions are uncontrolled except when stamped "CONTROLLED COPY" in red.
<b>DESCRIPTION:</b>	<b>TSOP-5 3.00x1.50x0.95, 0.95P</b>	<b>PAGE 1 OF 1</b>

onsemi and ONSEMI are trademarks of Semiconductor Components Industries, LLC dba onsemi or its subsidiaries in the United States and/or other countries. onsemi reserves the right to make changes without further notice to any products herein. onsemi makes no warranty, representation or guarantee regarding the suitability of its products for any particular purpose, nor does onsemi assume any liability arising out of the application or use of any product or circuit, and specifically disclaims any and all liability, including without limitation special, consequential or incidental damages. onsemi does not convey any license under its patent rights nor the rights of others.

# MECHANICAL CASE OUTLINE PACKAGE DIMENSIONS



**XDFN4 1.0x1.0, 0.65P**  
CASE 711AJ  
ISSUE C

DATE 08 MAR 2022



**NOTES:**

1. DIMENSIONING AND TOLERANCING PER ASME Y14.5M, 1994.
2. CONTROLLING DIMENSION: MILLIMETERS
3. DIMENSION *b* APPLIES TO THE PLATED TERMINALS AND IS MEASURED BETWEEN 0.15 AND 0.20 FROM THE TERMINAL TIPS.
4. COPLANARITY APPLIES TO THE EXPOSED PAD AS WELL AS THE TERMINALS.

DIM	MILLIMETERS		
	MIN	NOM	MAX
A	0.33	0.38	0.43
A1	0.00	---	0.05
A3	0.10 REF		
<i>b</i>	0.15	0.20	0.25
<i>b</i> 2	0.02	0.07	0.12
D	0.90	1.00	1.10
D2	0.43	0.48	0.53
E	0.90	1.00	1.10
<i>e</i>	0.65 BSC		
L	0.20		0.30
L2	0.07		0.17

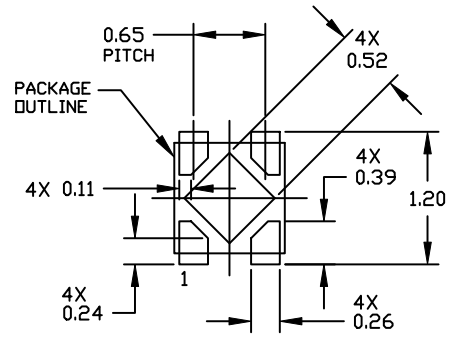
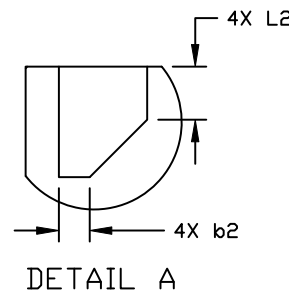
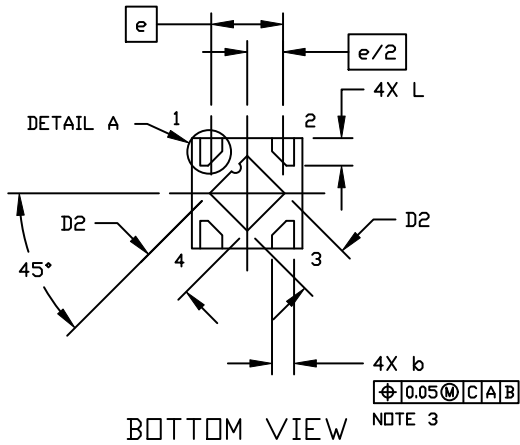

**RECOMMENDED  
MOUNTING FOOTPRINT**

\* FOR ADDITIONAL INFORMATION ON OUR Pb-FREE STRATEGY AND SOLDERING DETAILS, PLEASE DOWNLOAD THE ONSEMI SOLDERING AND MOUNT TECHNIQUES REFERENCE MANUAL, SOLDERRM/D

**GENERIC  
MARKING DIAGRAM\***

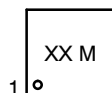

XX = Specific Device Code  
M = Date Code

\*This information is generic. Please refer to device data sheet for actual part marking. Pb-Free indicator, "G" or microdot "•", may or may not be present. Some products may not follow the Generic Marking.

<b>DOCUMENT NUMBER:</b>	<b>98AON67179E</b>	Electronic versions are uncontrolled except when accessed directly from the Document Repository. Printed versions are uncontrolled except when stamped "CONTROLLED COPY" in red.
<b>DESCRIPTION:</b>	<b>XDFN4, 1.0X1.0, 0.65P</b>	<b>PAGE 1 OF 1</b>

onsemi and ONSEMI are trademarks of Semiconductor Components Industries, LLC dba onsemi or its subsidiaries in the United States and/or other countries. onsemi reserves the right to make changes without further notice to any products herein. onsemi makes no warranty, representation or guarantee regarding the suitability of its products for any particular purpose, nor does onsemi assume any liability arising out of the application or use of any product or circuit, and specifically disclaims any and all liability, including without limitation special, consequential or incidental damages. onsemi does not convey any license under its patent rights nor the rights of others.

**onsemi**, **Onsemi**, and other names, marks, and brands are registered and/or common law trademarks of Semiconductor Components Industries, LLC dba "**onsemi**" or its affiliates and/or subsidiaries in the United States and/or other countries. **onsemi** owns the rights to a number of patents, trademarks, copyrights, trade secrets, and other intellectual property. A listing of **onsemi**'s product/patent coverage may be accessed at [www.onsemi.com/site/pdf/Patent-Marking.pdf](http://www.onsemi.com/site/pdf/Patent-Marking.pdf). **onsemi** reserves the right to make changes at any time to any products or information herein, without notice. The information herein is provided "as-is" and **onsemi** makes no warranty, representation or guarantee regarding the accuracy of the information, product features, availability, functionality, or suitability of its products for any particular purpose, nor does **onsemi** assume any liability arising out of the application or use of any product or circuit, and specifically disclaims any and all liability, including without limitation special, consequential or incidental damages. Buyer is responsible for its products and applications using **onsemi** products, including compliance with all laws, regulations and safety requirements or standards, regardless of any support or applications information provided by **onsemi**. "Typical" parameters which may be provided in **onsemi** data sheets and/or specifications can and do vary in different applications and actual performance may vary over time. All operating parameters, including "Typicals" must be validated for each customer application by customer's technical experts. **onsemi** does not convey any license under any of its intellectual property rights nor the rights of others. **onsemi** products are not designed, intended, or authorized for use as a critical component in life support systems or any FDA Class 3 medical devices or medical devices with a same or similar classification in a foreign jurisdiction or any devices intended for implantation in the human body. Should Buyer purchase or use **onsemi** products for any such unintended or unauthorized application, Buyer shall indemnify and hold **onsemi** and its officers, employees, subsidiaries, affiliates, and distributors harmless against all claims, costs, damages, and expenses, and reasonable attorney fees arising out of, directly or indirectly, any claim of personal injury or death associated with such unintended or unauthorized use, even if such claim alleges that **onsemi** was negligent regarding the design or manufacture of the part. **onsemi** is an Equal Opportunity/Affirmative Action Employer. This literature is subject to all applicable copyright laws and is not for resale in any manner.

## ADDITIONAL INFORMATION

### TECHNICAL PUBLICATIONS:

Technical Library: [www.onsemi.com/design/resources/technical-documentation](http://www.onsemi.com/design/resources/technical-documentation)  
onsemi Website: [www.onsemi.com](http://www.onsemi.com)

### ONLINE SUPPORT: [www.onsemi.com/support](http://www.onsemi.com/support)

For additional information, please contact your local Sales Representative at [www.onsemi.com/support/sales](http://www.onsemi.com/support/sales)

## Looking for pricing, stock, or lifecycle information?

Click below to explore more details on WIN SOURCE:

 [View NCV8163ASN300T1G on WIN SOURCE](#)

 [ON Semiconductor](#) Information

## Optimize Your Supply Chain with WIN SOURCE Solutions

-  Global Sourcing Solution
-  Obsolete Management
-  Cost Control Management
-  Shortage Management
-  Alternative Solution
-  Excess Inventory Management