



THE DATASHEET OF RS3D-13



Features

- Glass Passivated Die Construction
- Fast Recovery Time for High Efficiency
- Low Forward Voltage Drop and High Current Capability
- Surge Overload Rating to 100A Peak
- Ideally Suited for Automatic Assembly
- Plastic Material: UL Flammability Classification Rating 94V-0

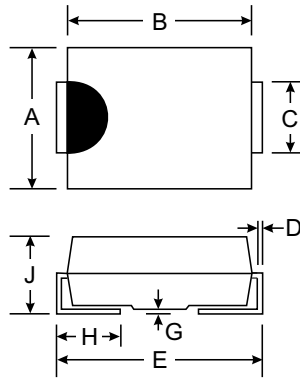

| Dim | SMB | | SMC | |
|----------------------|------|------|------|------|
| | Min | Max | Min | Max |
| A | 3.30 | 3.94 | 5.59 | 6.22 |
| B | 4.06 | 4.57 | 6.60 | 7.11 |
| C | 1.96 | 2.21 | 2.75 | 3.18 |
| D | 0.15 | 0.31 | 0.15 | 0.31 |
| E | 5.00 | 5.59 | 7.75 | 8.13 |
| G | 0.10 | 0.20 | 0.10 | 0.20 |
| H | 0.76 | 1.52 | 0.76 | 1.52 |
| J | 2.00 | 2.62 | 2.00 | 2.62 |
| All Dimensions in mm | | | | |

Mechanical Data

- Case: Molded Plastic
- Terminals: Solder Plated Terminal - Solderable per MIL-STD-202, Method 208
- Polarity: Cathode Band or Cathode Notch
- Marking: Type Number
- SMB Weight: 0.09 grams (approx.)
- SMC Weight: 0.20 grams (approx.)

AB, BB, DB, GB, JB, KB, MB Suffix Designates SMB Package
A, B, D, G, J, K, M Suffix Designates SMC Package

Maximum Ratings and Electrical Characteristics @ T_A = 25°C unless otherwise specified

Single phase, half wave, 60Hz, resistive or inductive load.
For capacitive load, derate current by 20%.

| Characteristic | Symbol | RS3 A/AB | RS3 B/BB | RS3 D/DB | RS3 G/GB | RS3 J/JB | RS3 K/KB | RS3 M/MB | Unit |
|-----------------------------------------------------------------------------------------------------------------------|--------------------------------------------------------|-------------|----------|----------|----------|----------|----------|----------|------|
| Peak Repetitive Reverse Voltage Working Peak Reverse Voltage DC Blocking Voltage | V _{RRM} V _{RWM} V _R | 50 | 100 | 200 | 400 | 600 | 800 | 1000 | V |
| RMS Reverse Voltage | V _{R(RMS)} | 35 | 70 | 140 | 280 | 420 | 560 | 700 | V |
| Average Rectified Output Current @ T _T = 75°C | I _O | 3.0 | | | | | | | A |
| Non-Repetitive Peak Forward Surge Current 8.3ms Single half sine-wave Superimposed on Rated Load (JEDEC Method) | I _{FSM} | 100 | | | | | | | A |
| Forward Voltage @ I _F = 3.0A | V _{FM} | 1.3 | | | | | | | V |
| Peak Reverse Current @ T _A = 25°C at Rated DC Blocking Voltage @ T _A = 125°C | I _{RM} | 5.0 250 | | | | | | | μA |
| Maximum Recovery Time (Note 3) | t _{rr} | 150 | | | | 250 | 500 | | ns |
| Typical Junction Capacitance (Note 2) | C _j | 50 | | | | | | | pF |
| Typical Thermal Resistance Junction to Terminal (Note 1) | R _{θJT} | 25 | | | | | | | K/W |
| Operating and Storage Temperature Range | T _j , T _{STG} | -65 to +150 | | | | | | | °C |

- Notes:
1. Thermal resistance: junction to terminal, unit mounted on PC board with 5.0 mm² (0.013 mm thick) copper pad as heat sink.
 2. Measured at 1.0MHz and applied reverse voltage of 4.0V DC.
 3. Reverse recovery test conditions: I_F = 0.5A, I_R = 1.0A, I_{rr} = 0.25A. See figure 5.

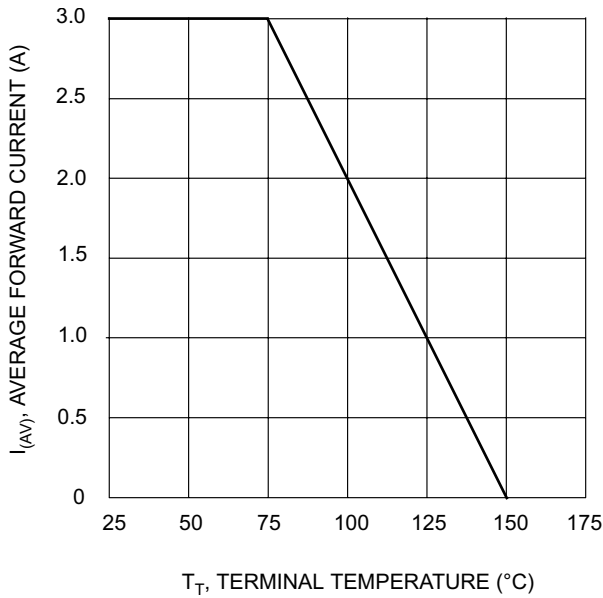

T_T , TERMINAL TEMPERATURE (°C)
Fig. 1 Forward Current Derating Curve

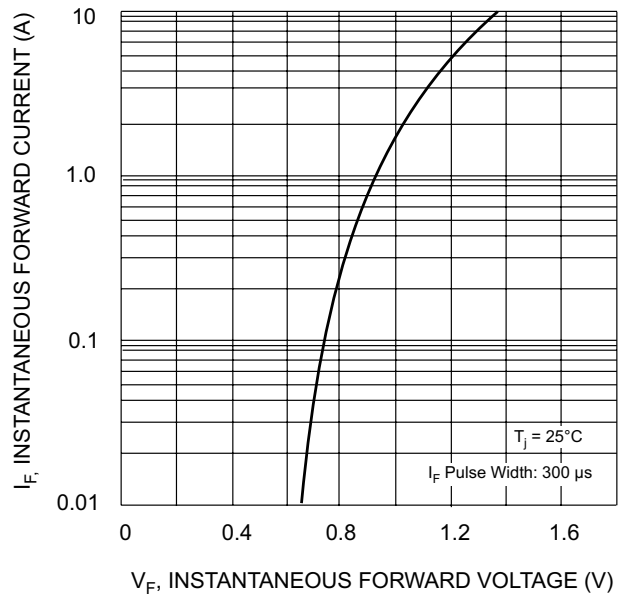

V_F , INSTANTANEOUS FORWARD VOLTAGE (V)
Fig. 2 Typical Forward Characteristics

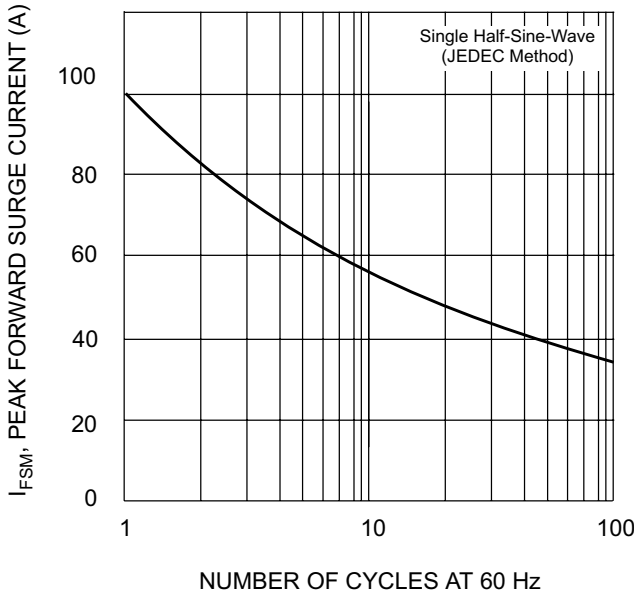

NUMBER OF CYCLES AT 60 Hz
Fig. 3 Forward Surge Current Derating Curve

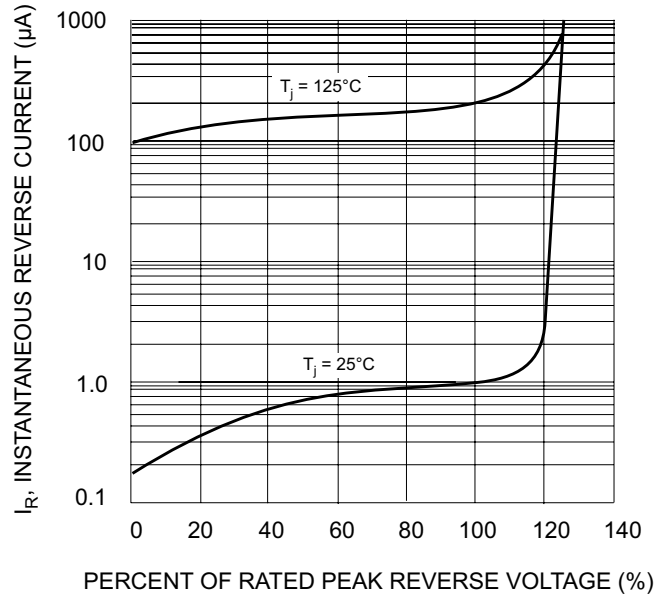

PERCENT OF RATED PEAK REVERSE VOLTAGE (%)
Fig. 4 Typical Reverse Characteristics

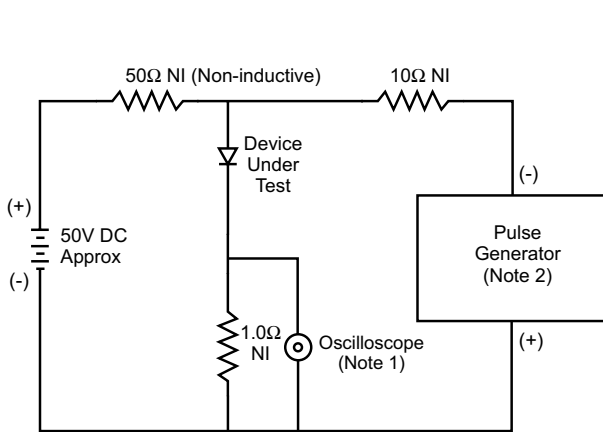

- Notes:
 1. Rise Time = 7.0ns max. Input Impedance = 1.0MΩ, 22pF.
 2. Rise Time = 10ns max. Input Impedance = 50Ω.

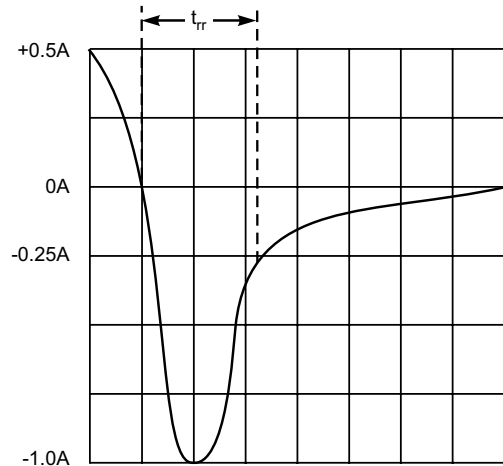



Set time base for 50/100 ns/cm

Fig. 5 Reverse Recovery Time Characteristic and Test Circuit

Looking for pricing, stock, or lifecycle information?

Click below to explore more details on WIN SOURCE:

-  [View RS3D-13 on WIN SOURCE](#)
-  [Diodes Incorporated](#) Information

Optimize Your Supply Chain with WIN SOURCE Solutions

-  Global Sourcing Solution
-  Obsolete Management
-  Cost Control Management
-  Shortage Management
-  Alternative Solution
-  Excess Inventory Management