



**THE DATASHEET OF  
NVMYS010N04CLTWG**



# NVMYS010N04CL

## MOSFET – Power, Single N-Channel 40 V, 10.3 mΩ, 38 A

### Features

- Small Footprint (5x6 mm) for Compact Design
- Low  $R_{DS(on)}$  to Minimize Conduction Losses
- Low  $Q_G$  and Capacitance to Minimize Driver Losses
- LFPK4 Package, Industry Standard
- AEC-Q101 Qualified and PPAP Capable
- These Devices are Pb-Free and are RoHS Compliant

### MAXIMUM RATINGS ( $T_J = 25^\circ\text{C}$ unless otherwise noted)

| Parameter   | Symbol   | Value                     | Unit             |   |
|---|--|---------------------------|------------------|---|
| Drain-to-Source Voltage   | $V_{DSS}$                                      | 40                        | V                |   |
| Gate-to-Source Voltage  | $V_{GS}$                                       | $\pm 20$                  | V                |   |
| Continuous Drain Current $R_{\theta JC}$ (Notes 1, 2, 3)  | Steady State                                   | $T_C = 25^\circ\text{C}$  | $I_D$ 38         | A |
|   |  | $T_C = 100^\circ\text{C}$ | 27               |   |
| Power Dissipation $R_{\theta JC}$ (Notes 1, 2)  | Steady State                                   | $T_C = 25^\circ\text{C}$  | $P_D$ 28         | W |
|   |  | $T_C = 100^\circ\text{C}$ | 14               |   |
| Continuous Drain Current $R_{\theta JA}$ (Notes 1, 2, 3)  | Steady State                                   | $T_A = 25^\circ\text{C}$  | $I_D$ 14         | A |
|   |  | $T_A = 100^\circ\text{C}$ | 9.9              |   |
| Power Dissipation $R_{\theta JA}$ (Notes 1, 2)  | Steady State                                   | $T_A = 25^\circ\text{C}$  | $P_D$ 3.8        | W |
|   |  | $T_A = 100^\circ\text{C}$ | 1.9              |   |
| Pulsed Drain Current  | $T_A = 25^\circ\text{C}, t_p = 10 \mu\text{s}$ | $I_{DM}$ 187              | A                |   |
| Operating Junction and Storage Temperature  | $T_J, T_{stg}$                                 | -55 to +175               | $^\circ\text{C}$ |   |
| Source Current (Body Diode)   | $I_S$  | 24                        | A                |   |
| Single Pulse Drain-to-Source Avalanche Energy ( $T_J = 25^\circ\text{C}, I_{L(pk)} = 1.9 \text{ A}$ ) | $E_{AS}$                                       | 62                        | mJ               |   |
| Lead Temperature for Soldering Purposes (1/8" from case for 10 s)                                     | $T_L$  | 260                       | $^\circ\text{C}$ |   |

Stresses exceeding those listed in the Maximum Ratings table may damage the device. If any of these limits are exceeded, device functionality should not be assumed, damage may occur and reliability may be affected.

### THERMAL RESISTANCE MAXIMUM RATINGS

| Parameter                                   | Symbol          | Value | Unit                      |
|---|-----------------|-------|---------------------------|
| Junction-to-Case – Steady State             | $R_{\theta JC}$ | 5.3   | $^\circ\text{C}/\text{W}$ |
| Junction-to-Ambient – Steady State (Note 2) | $R_{\theta JA}$ | 39    |                           |

1. The entire application environment impacts the thermal resistance values shown, they are not constants and are only valid for the particular conditions noted.
2. Surface-mounted on FR4 board using a 650 mm<sup>2</sup>, 2 oz. Cu pad.
3. Maximum current for pulses as long as 1 second is higher but is dependent on pulse duration and duty cycle.



ON Semiconductor®

[www.onsemi.com](http://www.onsemi.com)

| $V_{(BR)DSS}$ | $R_{DS(ON) MAX}$ | $I_D MAX$ |
|---------------|------------------|-----------|
| 40 V          | 10.3 mΩ @ 10 V   | 38 A      |
|               | 17.6 mΩ @ 4.5 V  |           |

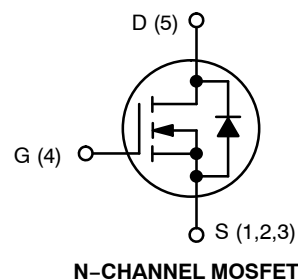

LFPK4  
CASE 760AB

### MARKING DIAGRAM

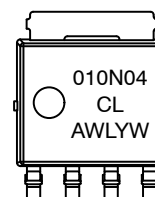

010N04CL = Specific Device Code  
A = Assembly Location  
WL = Wafer Lot  
Y = Year  
W = Work Week

### ORDERING INFORMATION

See detailed ordering, marking and shipping information on page 5 of this data sheet.

# NVMYS010N04CL

## ELECTRICAL CHARACTERISTICS ( $T_J = 25^\circ\text{C}$ unless otherwise specified)

| Parameter   | Symbol            | Test Condition                                | Min                       | Typ | Max | Unit          |
|---|-------------------|---|---------------------------|-----|-----|---------------|
| <b>OFF CHARACTERISTICS</b>                                |                   |   |                           |     |     |               |
| Drain-to-Source Breakdown Voltage                         | $V_{(BR)DSS}$     | $V_{GS} = 0\text{ V}, I_D = 250\ \mu\text{A}$ | 40                        |     |     | V             |
| Drain-to-Source Breakdown Voltage Temperature Coefficient | $V_{(BR)DSS}/T_J$ |   |                           | 24  |     | mV/°C         |
| Zero Gate Voltage Drain Current                           | $I_{DSS}$         | $V_{GS} = 0\text{ V}, V_{DS} = 40\text{ V}$   | $T_J = 25^\circ\text{C}$  |     | 10  | $\mu\text{A}$ |
|   |                   |   | $T_J = 125^\circ\text{C}$ |     | 250 |               |
| Gate-to-Source Leakage Current                            | $I_{GSS}$         | $V_{DS} = 0\text{ V}, V_{GS} = 20\text{ V}$   |                           |     | 100 | nA            |

## ON CHARACTERISTICS (Note 4)

|                                   |                  |  |     |      |      |            |
|-----------------------------------|------------------|--|-----|------|------|------------|
| Gate Threshold Voltage            | $V_{GS(TH)}$     | $V_{GS} = V_{DS}, I_D = 20\ \mu\text{A}$   | 1.2 |      | 2.0  | V          |
| Threshold Temperature Coefficient | $V_{GS(TH)}/T_J$ |  |     | -5.5 |      | mV/°C      |
| Drain-to-Source On Resistance     | $R_{DS(on)}$     | $V_{GS} = 10\text{ V}, I_D = 20\text{ A}$  |     | 8.6  | 10.3 | m $\Omega$ |
|                                   |                  | $V_{GS} = 4.5\text{ V}, I_D = 20\text{ A}$ |     | 14.5 | 17.6 |            |
| Forward Transconductance          | $g_{FS}$         | $V_{DS} = 15\text{ V}, I_D = 20\text{ A}$  |     | 33   |      | S          |

## CHARGES, CAPACITANCES & GATE RESISTANCE

|                              |              |  |  |     |     |    |
|------------------------------|--------------|--|--|-----|-----|----|
| Input Capacitance            | $C_{ISS}$    | $V_{GS} = 0\text{ V}, f = 1\text{ MHz}, V_{DS} = 25\text{ V}$    |  | 570 |     | pF |
| Output Capacitance           | $C_{OSS}$    |  |  | 230 |     |    |
| Reverse Transfer Capacitance | $C_{RSS}$    |  |  | 11  |     |    |
| Total Gate Charge            | $Q_{G(TOT)}$ | $V_{GS} = 10\text{ V}, V_{DS} = 20\text{ V}; I_D = 20\text{ A}$  |  | 7.3 |     | nC |
| Total Gate Charge            | $Q_{G(TOT)}$ | $V_{GS} = 4.5\text{ V}, V_{DS} = 20\text{ V}; I_D = 20\text{ A}$ |  | 3.4 |     | nC |
| Threshold Gate Charge        | $Q_{G(TH)}$  |  |  | 0.9 |     | nC |
| Gate-to-Source Charge        | $Q_{GS}$     |  |  | 1.6 |     |    |
| Gate-to-Drain Charge         | $Q_{GD}$     |  |  | 1.0 |     |    |
| Plateau Voltage              | $V_{GP}$     |  |  |     | 3.4 |    |

## SWITCHING CHARACTERISTICS (Note 5)

|                     |              |   |  |    |  |    |
|---------------------|--------------|---|--|----|--|----|
| Turn-On Delay Time  | $t_{d(ON)}$  | $V_{GS} = 4.5\text{ V}, V_{DS} = 20\text{ V}, I_D = 20\text{ A}, R_G = 1\ \Omega$ |  | 7  |  | ns |
| Rise Time           | $t_r$        |   |  | 43 |  |    |
| Turn-Off Delay Time | $t_{d(OFF)}$ |   |  | 11 |  |    |
| Fall Time           | $t_f$        |   |  | 2  |  |    |

## DRAIN-SOURCE DIODE CHARACTERISTICS

|                         |          |  |                           |  |      |     |    |
|-------------------------|----------|--|---------------------------|--|------|-----|----|
| Forward Diode Voltage   | $V_{SD}$ | $V_{GS} = 0\text{ V}, I_S = 20\text{ A}$                                     | $T_J = 25^\circ\text{C}$  |  | 0.88 | 1.2 | V  |
|                         |          |  | $T_J = 125^\circ\text{C}$ |  | 0.79 |     |    |
| Reverse Recovery Time   | $t_{RR}$ | $V_{GS} = 0\text{ V}, di_S/dt = 100\text{ A}/\mu\text{s}, I_S = 20\text{ A}$ |                           |  | 18   |     | ns |
| Charge Time             | $t_a$    |  |                           |  | 9    |     |    |
| Discharge Time          | $t_b$    |  |                           |  | 9    |     |    |
| Reverse Recovery Charge | $Q_{RR}$ |  |                           |  | 6.0  |     |    |

Product parametric performance is indicated in the Electrical Characteristics for the listed test conditions, unless otherwise noted. Product performance may not be indicated by the Electrical Characteristics if operated under different conditions.

4. Pulse Test: pulse width  $\leq 300\ \mu\text{s}$ , duty cycle  $\leq 2\%$ .
5. Switching characteristics are independent of operating junction temperatures.

TYPICAL CHARACTERISTICS

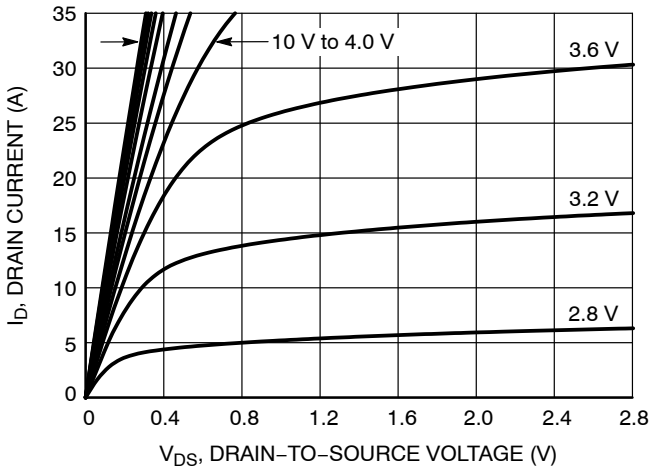

Figure 1. On-Region Characteristics

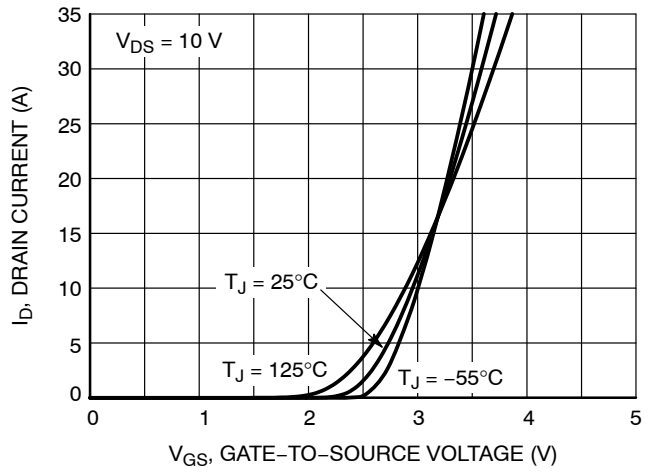

Figure 2. Transfer Characteristics

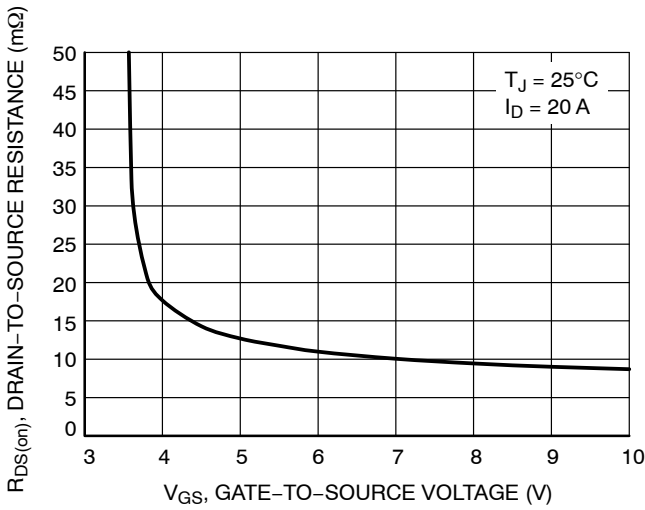

Figure 3. On-Resistance vs. Gate-to-Source Voltage

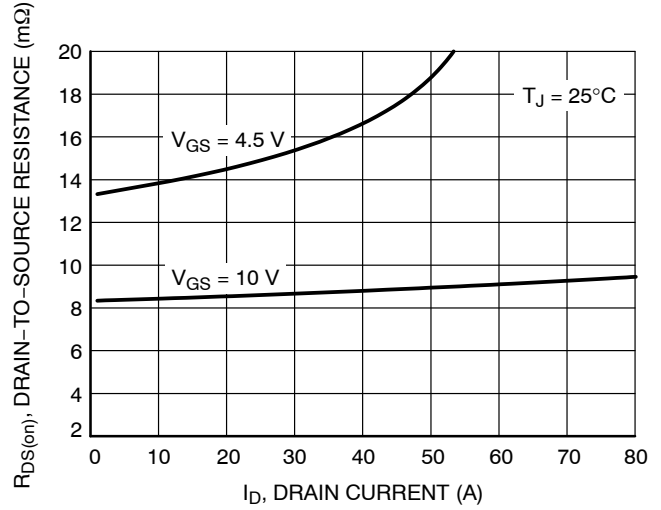

Figure 4. On-Resistance vs. Drain Current and Gate Voltage

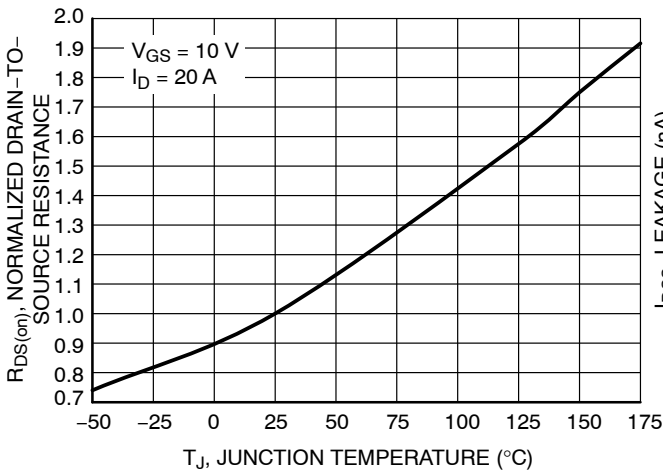

Figure 5. On-Resistance Variation with Temperature

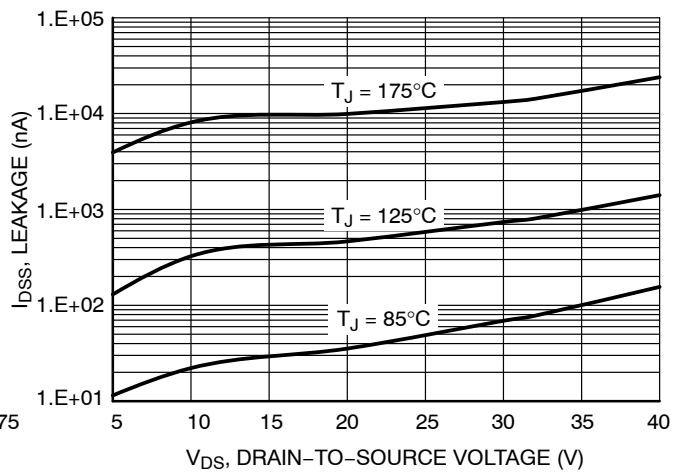

Figure 6. Drain-to-Source Leakage Current vs. Voltage

TYPICAL CHARACTERISTICS

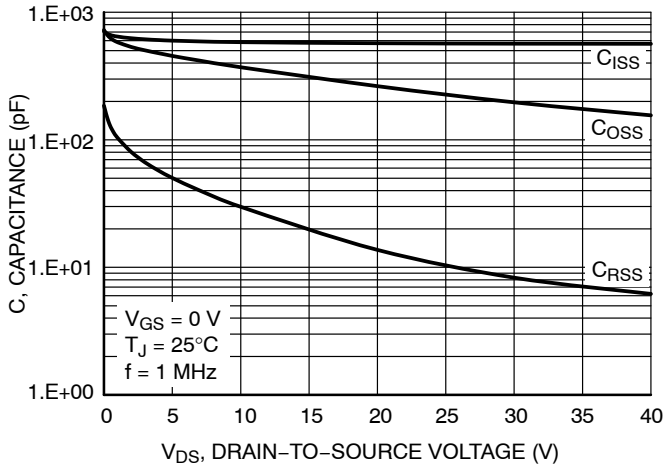

Figure 7. Capacitance Variation

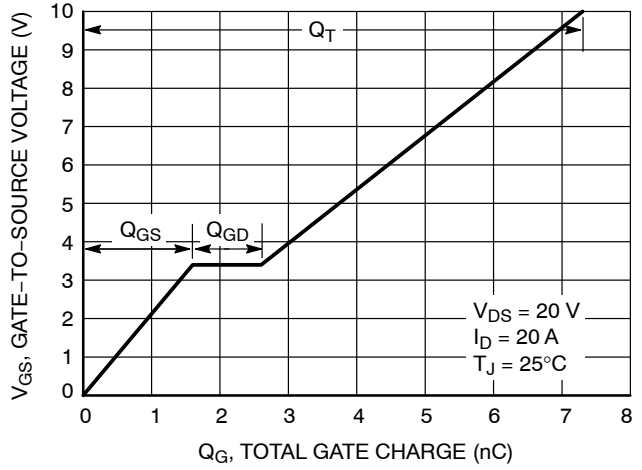

Figure 8. Gate-to-Source vs. Total Charge

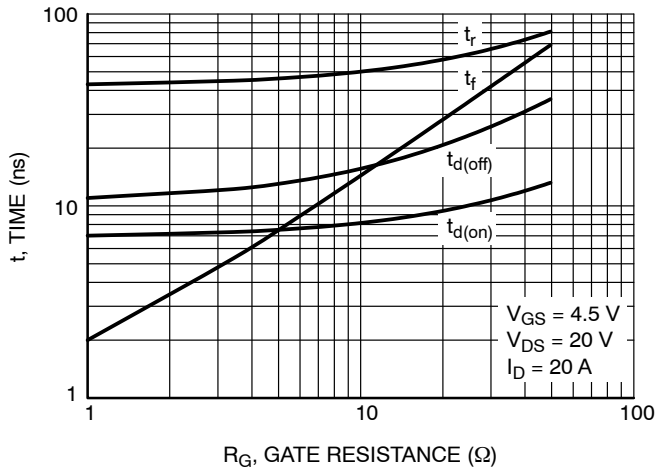

Figure 9. Resistive Switching Time Variation vs. Gate Resistance

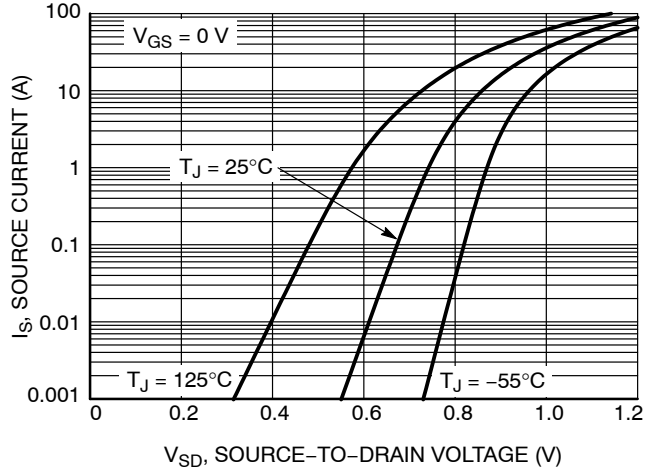

Figure 10. Diode Forward Voltage vs. Current

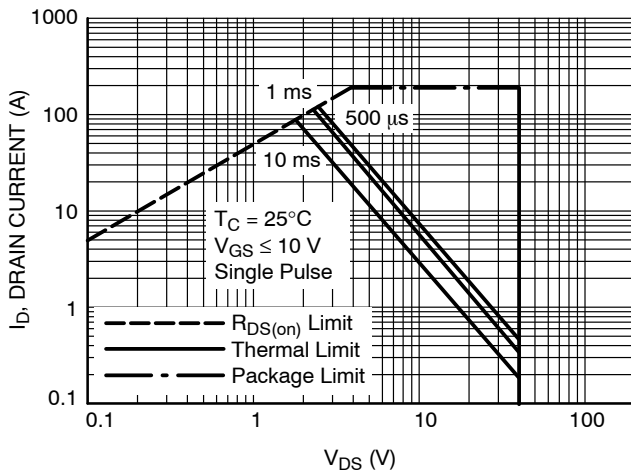

Figure 11. Safe Operating Area

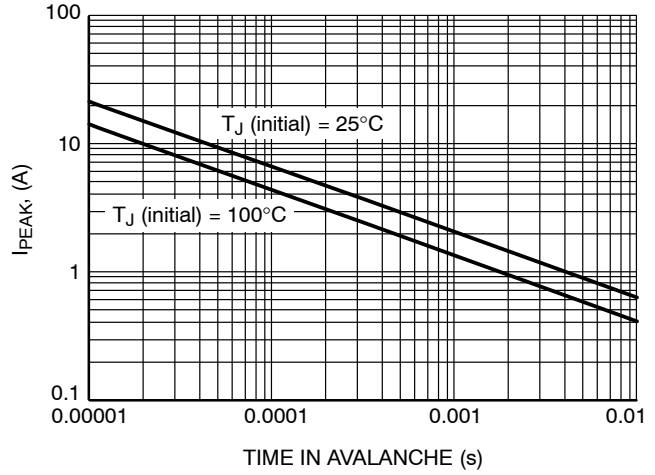

Figure 12.  $I_{PEAK}$  vs. Time in Avalanche

# NVMYS010N04CL

## TYPICAL CHARACTERISTICS

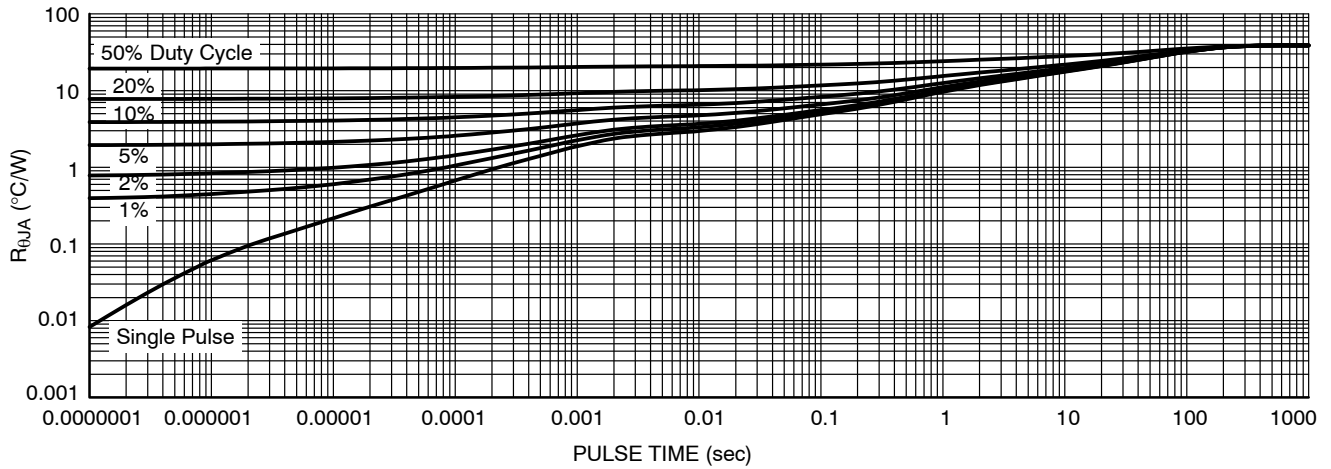

Figure 13. Thermal Characteristics

### DEVICE ORDERING INFORMATION

| Device           | Marking  | Package            | Shipping <sup>†</sup> |
|------------------|----------|--------------------|-----------------------|
| NVMYS010N04CLTWG | 010N04CL | LFPK4<br>(Pb-Free) | 3000 / Tape & Reel    |

<sup>†</sup>For information on tape and reel specifications, including part orientation and tape sizes, please refer to our Tape and Reel Packaging Specifications Brochure, BRD8011/D.

# MECHANICAL CASE OUTLINE

## PACKAGE DIMENSIONS

ON Semiconductor®



### LFLPAK4 4.90x4.15x1.15MM, 1.27P

#### CASE 760AB

#### ISSUE D

DATE 22 MAY 2024

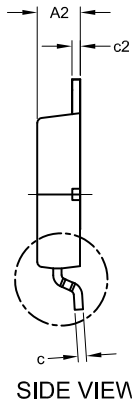
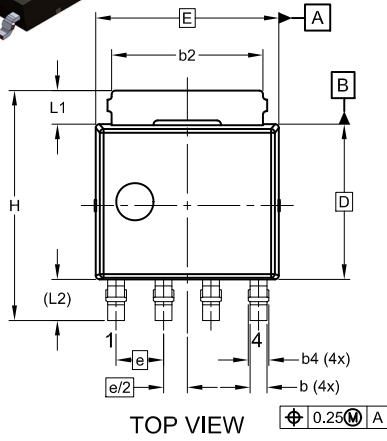
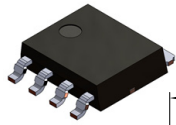

**NOTES:**

1. DIMENSIONING AND TOLERANCING PER ASME Y14.5M, 2018.
2. CONTROLLING DIMENSION: MILLIMETERS.
3. DIMENSIONS D AND E DO NOT INCLUDE MOLD FLASH, PROTRUSIONS, OR BURRS. MOLD FLASH PROTRUSIONS OR GATE BURRS SHALL NOT EXCEED 0.150mm PER SIDE.
4. DIMENSIONS D AND E ARE DETERMINED AT THE OUTERMOST EXTREMES OF THE PLASTIC BODY.

TOP VIEW  $\varnothing 0.25 \text{mm} \text{ A}$

SIDE VIEW

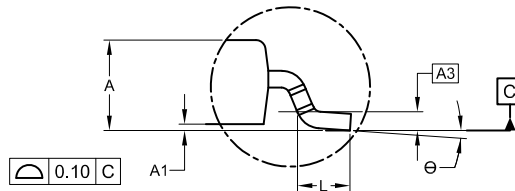

DETAIL 'A'  
SCALE: 2:1

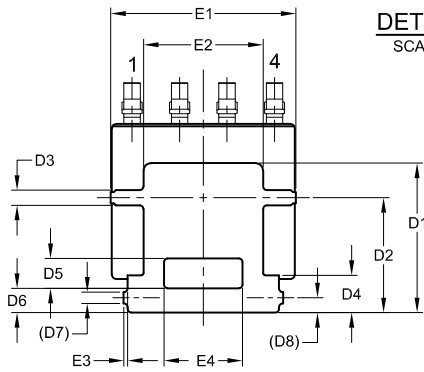

BOTTOM VIEW

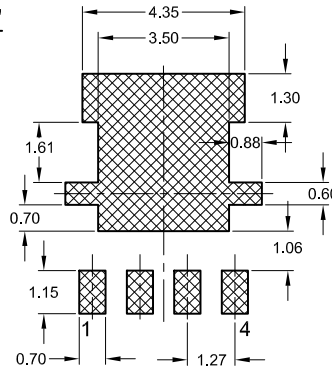

RECOMMENDED LAND PATTERN

\*FOR ADDITIONAL INFORMATION ON OUR PB-FREE STRATEGY AND SOLDERING DETAILS, PLEASE DOWNLOAD THE ONSEMI SOLDERING AND MOUNTING TECHNIQUES REFERENCE MANUAL, SOLDERRM/D.

### GENERIC MARKING DIAGRAM\*

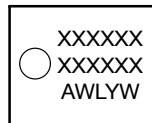

XXXXXX = Specific Device Code  
 A = Assembly Location  
 WL = Wafer Lot  
 Y = Year  
 W = Work Week

\*This information is generic. Please refer to device data sheet for actual part marking. Some products may not follow the Generic Marking.

| MILLIMETER |           |      |      |
|------------|-----------|------|------|
| DIM        | MIN       | NOM  | MAX  |
| A          | 1.10      | 1.20 | 1.30 |
| A1         | 0.00      | 0.08 | 0.15 |
| A2         | 1.10      | 1.15 | 1.20 |
| A3         | 0.25 BSC  |      |      |
| b          | 0.40      | 0.45 | 0.50 |
| b2         | 3.80      | 4.10 | 4.40 |
| b4         | 0.45      | 0.55 | 0.65 |
| c          | 0.19      | 0.22 | 0.25 |
| c2         | 0.19      | 0.22 | 0.25 |
| D          | 4.15 BSC  |      |      |
| D1         | 3.80      | 4.00 | 4.20 |
| D2         | 3.00      | 3.10 | 3.20 |
| D3         | 0.30      | 0.40 | 0.50 |
| D4         | 0.90      | 1.00 | 1.10 |
| D5         | 0.70      | 0.80 | 0.90 |
| D6         | 0.55      | 0.65 | 0.75 |
| D7         | 0.31 REF  |      |      |
| D8         | 0.40 REF  |      |      |
| E          | 4.90 BSC  |      |      |
| E1         | 4.85      | 4.95 | 5.05 |
| E2         | 3.10      | 3.20 | 3.30 |
| E3         | 0.00      | 0.10 | 0.20 |
| E4         | 2.00      | 2.10 | 2.20 |
| e          | 1.27 BSC  |      |      |
| e/2        | 0.635 BSC |      |      |
| e1         | 0.40 REF  |      |      |
| H          | 6.00      | 6.15 | 6.30 |
| L          | 0.50      | 0.70 | 0.90 |
| L1         | 0.80      | 0.90 | 1.00 |
| L2         | 1.10 REF  |      |      |
| Θ          | 0°        | 4°   | 8°   |

|                         |  |  |
|-------------------------|--|--|
| <b>DOCUMENT NUMBER:</b> | <b>98AON82777G</b>                     | Electronic versions are uncontrolled except when accessed directly from the Document Repository. Printed versions are uncontrolled except when stamped "CONTROLLED COPY" in red. |
| <b>DESCRIPTION:</b>     | <b>LFLPAK4 4.90x4.15x1.15MM, 1.27P</b> | <b>PAGE 1 OF 1</b>   |

ON Semiconductor and are trademarks of Semiconductor Components Industries, LLC dba ON Semiconductor or its subsidiaries in the United States and/or other countries. ON Semiconductor reserves the right to make changes without further notice to any products herein. ON Semiconductor makes no warranty, representation or guarantee regarding the suitability of its products for any particular purpose, nor does ON Semiconductor assume any liability arising out of the application or use of any product or circuit, and specifically disclaims any and all liability, including without limitation special, consequential or incidental damages. ON Semiconductor does not convey any license under its patent rights nor the rights of others.

**onsemi**, **Onsemi**, and other names, marks, and brands are registered and/or common law trademarks of Semiconductor Components Industries, LLC dba "**onsemi**" or its affiliates and/or subsidiaries in the United States and/or other countries. **onsemi** owns the rights to a number of patents, trademarks, copyrights, trade secrets, and other intellectual property. A listing of **onsemi**'s product/patent coverage may be accessed at [www.onsemi.com/site/pdf/Patent-Marking.pdf](http://www.onsemi.com/site/pdf/Patent-Marking.pdf). **onsemi** reserves the right to make changes at any time to any products or information herein, without notice. The information herein is provided "as-is" and **onsemi** makes no warranty, representation or guarantee regarding the accuracy of the information, product features, availability, functionality, or suitability of its products for any particular purpose, nor does **onsemi** assume any liability arising out of the application or use of any product or circuit, and specifically disclaims any and all liability, including without limitation special, consequential or incidental damages. Buyer is responsible for its products and applications using **onsemi** products, including compliance with all laws, regulations and safety requirements or standards, regardless of any support or applications information provided by **onsemi**. "Typical" parameters which may be provided in **onsemi** data sheets and/or specifications can and do vary in different applications and actual performance may vary over time. All operating parameters, including "Typicals" must be validated for each customer application by customer's technical experts. **onsemi** does not convey any license under any of its intellectual property rights nor the rights of others. **onsemi** products are not designed, intended, or authorized for use as a critical component in life support systems or any FDA Class 3 medical devices or medical devices with a same or similar classification in a foreign jurisdiction or any devices intended for implantation in the human body. Should Buyer purchase or use **onsemi** products for any such unintended or unauthorized application, Buyer shall indemnify and hold **onsemi** and its officers, employees, subsidiaries, affiliates, and distributors harmless against all claims, costs, damages, and expenses, and reasonable attorney fees arising out of, directly or indirectly, any claim of personal injury or death associated with such unintended or unauthorized use, even if such claim alleges that **onsemi** was negligent regarding the design or manufacture of the part. **onsemi** is an Equal Opportunity/Affirmative Action Employer. This literature is subject to all applicable copyright laws and is not for resale in any manner.

## ADDITIONAL INFORMATION

### TECHNICAL PUBLICATIONS:

Technical Library: [www.onsemi.com/design/resources/technical-documentation](http://www.onsemi.com/design/resources/technical-documentation)  
onsemi Website: [www.onsemi.com](http://www.onsemi.com)

### ONLINE SUPPORT: [www.onsemi.com/support](http://www.onsemi.com/support)

For additional information, please contact your local Sales Representative at [www.onsemi.com/support/sales](http://www.onsemi.com/support/sales)

## Looking for pricing, stock, or lifecycle information?

Click below to explore more details on WIN SOURCE:

- ⊖ [View NVMYS010N04CLTWG on WIN SOURCE](#)
- ⊖ [ON Semiconductor Information](#)

## Optimize Your Supply Chain with WIN SOURCE Solutions

- ✓ Global Sourcing Solution
- ✓ Obsolete Management
- ✓ Cost Control Management
- ✓ Shortage Management
- ✓ Alternative Solution
- ✓ Excess Inventory Management