



# THE DATASHEET OF PDTD114EUX





# PDTD1xxxU series

500 mA, 50 V NPN resistor-equipped transistors

Rev. 1 — 13 May 2014

Product data sheet

## 1. Product profile

### 1.1 General description

NPN Resistor-Equipped Transistor (RET) family in a very small SOT323 (SC-70) Surface-Mounted Device (SMD) plastic package.

Table 1. Product overview

Type number	Package			PNP complement	Package configuration
	Nexperia	JEITA	JEDEC		
PDTD113EU	SOT323	SC-70	-	PDTB113EU	very small
PDTD113ZU				PDTB113ZU	
PDTD123EU				PDTB123EU	
PDTD123YU				PDTB123YU	
PDTD143EU				PDTB143EU	
PDTD143XU				PDTB143XU	
PDTD114EU				PDTB114EU	

### 1.2 Features

- 500 mA output current capability
- Built-in bias resistors
- Simplifies circuit design
- Reduces component count
- $\pm 10\%$  resistor ratio tolerance
- AEC-Q101 qualified
- High temperature applications up to 175 °C

### 1.3 Applications

- IC inputs control
- Cost-saving alternative to BC807 or BC817 series transistors in digital applications
- Switching loads

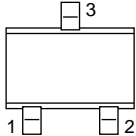
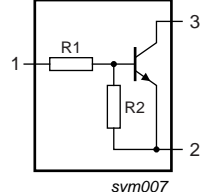
## 1.4 Quick reference data

Table 2. Quick reference data

Symbol	Parameter	Conditions	Min	Typ	Max	Unit
$V_{CE0}$	collector-emitter voltage	open base	-	-	50	V
$I_O$	output current		-	-	500	mA
R1	bias resistor 1 (input)					
	PDTD113EU			1		k $\Omega$
	PDTD113ZU			1		k $\Omega$
	PDTD123EU			2.2		k $\Omega$
	PDTD123YU			2.2		k $\Omega$
	PDTD143EU			4.7		k $\Omega$
	PDTD143XU			4.7		k $\Omega$
	PDTD114EU			10		k $\Omega$
R2	bias resistor 2 (base-emitter)					
	PDTD113EU			1		k $\Omega$
	PDTD113ZU			10		k $\Omega$
	PDTD123EU			2.2		k $\Omega$
	PDTD123YU			10		k $\Omega$
	PDTD143EU			4.7		k $\Omega$
	PDTD143XU			10		k $\Omega$
	PDTD114EU			10		k $\Omega$

## 2. Pinning information

Table 3. Pinning

Pin	Description	Simplified outline	Graphic symbol
1	input (base)		 sym007
2	GND (emitter)		
3	output (collector)		

## 3. Ordering information

Table 4. Ordering information

Type number	Package		
	Name	Description	Version
PDTD1xxxU series	SC-70	plastic surface-mounted package; 3 leads	SOT323

## 4. Marking

Table 5. Marking codes

Type number	Marking code <sup>[1]</sup>
PDTD113EU	ZP*
PDTD113ZU	ZQ*
PDTD123EU	ZR*
PDTD123YU	ZS*
PDTD143EU	ZT*
PDTD143XU	ZU*
PDTD114EU	ZV*

[1] \* = placeholder for manufacturing site code

## 5. Limiting values

Table 6. Limiting values

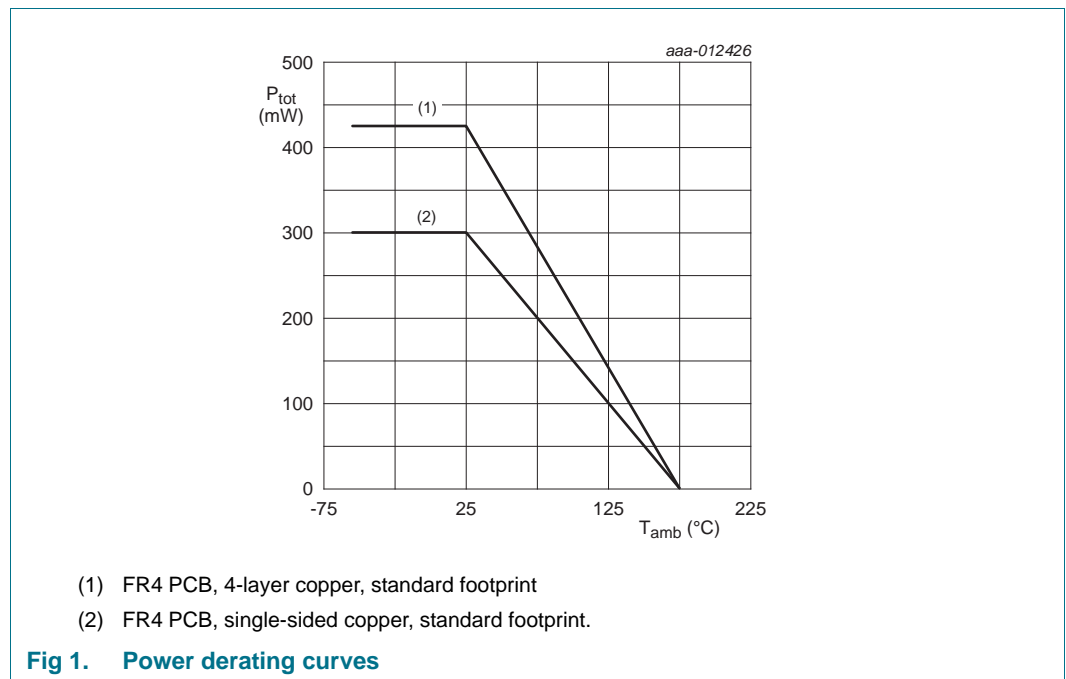
In accordance with the Absolute Maximum Rating System (IEC 60134).

Symbol	Parameter	Conditions	Min	Max	Unit
$V_{CBO}$	collector-base voltage	open emitter	-	50	V
$V_{CEO}$	collector-emitter voltage	open base	-	50	V
$V_{EBO}$	emitter-base voltage	open collector			
	PDTD113EU		-	10	V
	PDTD113ZU		-	5	V
	PDTD123EU		-	10	V
	PDTD123YU		-	5	V
	PDTD143EU		-	10	V
	PDTD143XU		-	7	V
	PDTD114EU		-	10	V
$V_I$	input voltage				
	PDTD113EU		-10	+10	V
	PDTD113ZU		-5	+10	V
	PDTD123EU		-10	+12	V
	PDTD123YU		-5	+12	V
	PDTD143EU		-10	+30	V
	PDTD143XU		-7	+30	V
	PDTD114EU		-10	+50	V
$I_O$	output current		-	500	mA

**Table 6. Limiting values ...continued**  
*In accordance with the Absolute Maximum Rating System (IEC 60134).*

Symbol	Parameter	Conditions	Min	Max	Unit
P <sub>tot</sub>	total power dissipation	T <sub>amb</sub> ≤ 25 °C	[1]	300	mW
			[2]	425	mW
T <sub>j</sub>	junction temperature		-	175	°C
T <sub>amb</sub>	ambient temperature		-55	+175	°C
T <sub>stg</sub>	storage temperature		-55	+175	°C

- [1] Device mounted on an FR4 Printed-Circuit Board (PCB), single-sided copper, tin-plated and standard footprint.
- [2] Device mounted on an FR4 PCB, 4-layer copper, tin-plated and standard footprint.

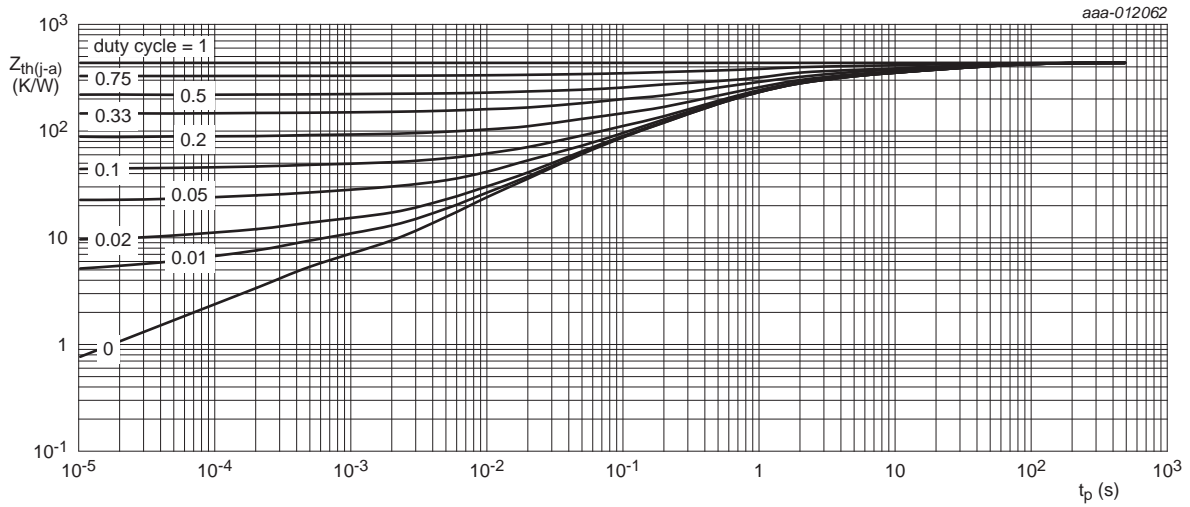


## 6. Thermal characteristics

**Table 7. Thermal characteristics**

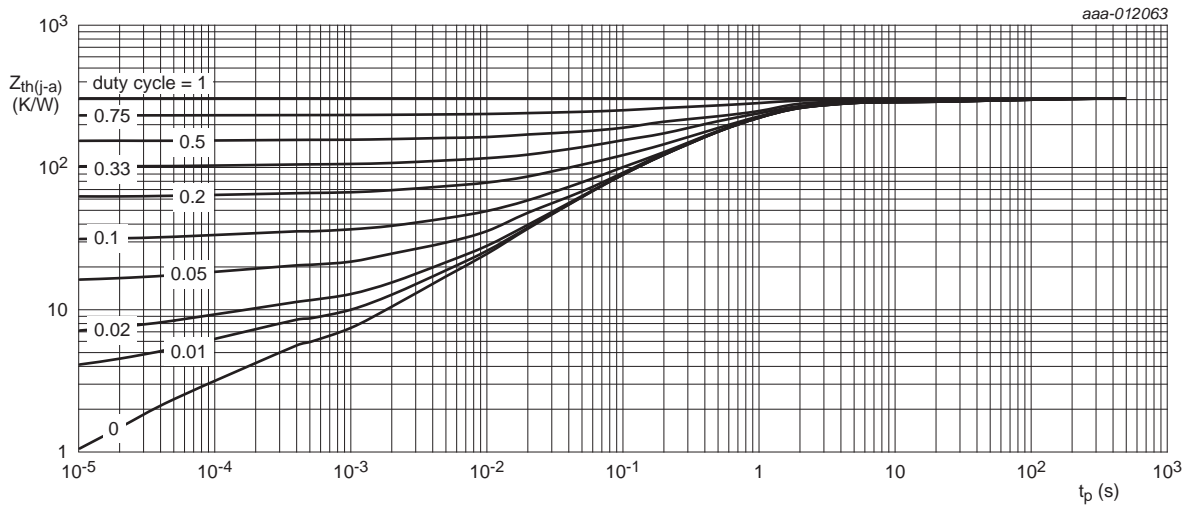
Symbol	Parameter	Conditions	Min	Typ	Max	Unit
R <sub>th(j-a)</sub>	thermal resistance from junction to ambient	in free air	[1]	-	500	K/W
			[2]	-	353	K/W

- [1] Device mounted on an FR4 PCB, single-sided copper, tin-plated and standard footprint.
- [2] Device mounted on an FR4 PCB, 4-layer copper, tin-plated and standard footprint.



FR4 PCB, single-sided copper, tin-plated and standard footprint

**Fig 2. Transient thermal impedance from junction to ambient as a function of pulse duration for SOT323/SC-70; typical values**



FR4 PCB, 4-layer copper, tin-plated and standard footprint.

**Fig 3. Transient thermal impedance from junction to ambient as a function of pulse duration for SOT323/SC-70; typical values**

## 7. Characteristics

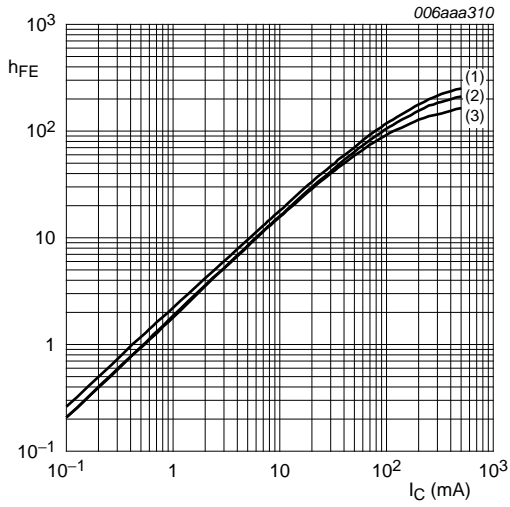
**Table 8. Characteristics**
 $T_{amb} = 25\text{ }^{\circ}\text{C}$  unless otherwise specified.

Symbol	Parameter	Conditions	Min	Typ	Max	Unit
$I_{CBO}$	collector-base cut-off current	$V_{CB} = 40\text{ V}; I_E = 0\text{ A}$	-	-	100	nA
		$V_{CB} = 50\text{ V}; I_E = 0\text{ A}$	-	-	100	nA
$I_{CEO}$	collector-emitter cut-off current	$V_{CE} = 50\text{ V}; I_B = 0\text{ A}$	-	-	0.5	$\mu\text{A}$
$I_{EBO}$	emitter-base cut-off current	$V_{EB} = 5\text{ V}; I_C = 0\text{ A}$				
	PDTD113EU		-	-	4.0	mA
	PDTD113ZU		-	-	0.8	mA
	PDTD123EU		-	-	2.0	mA
	PDTD123YU		-	-	0.65	mA
	PDTD143EU		-	-	0.9	mA
	PDTD143XU		-	-	0.6	mA
	PDTD114EU		-	-	0.4	mA
$h_{FE}$	DC current gain	$V_{CE} = 5\text{ V}; I_C = 50\text{ mA}$				
	PDTD113EU		33	-	-	
	PDTD113ZU		70	-	-	
	PDTD123EU		40	-	-	
	PDTD123YU		70	-	-	
	PDTD143EU		60	-	-	
	PDTD143XU		70	-	-	
	PDTD114EU		70	-	-	
$V_{CEsat}$	collector-emitter saturation voltage	$I_C = 50\text{ mA}; I_B = 2.5\text{ mA}$	-	-	100	mV
$V_{I(off)}$	off-state input voltage	$V_{CE} = 5\text{ V}; I_C = 100\text{ }\mu\text{A}$				
	PDTD113EU		0.6	1.1	1.5	V
	PDTD113ZU		0.3	0.6	1.0	V
	PDTD123EU		0.6	1.1	1.8	V
	PDTD123YU		0.4	0.6	1.0	V
	PDTD143EU		0.6	0.9	1.5	V
	PDTD143XU		0.5	0.75	1.1	V
	PDTD114EU		0.6	1.0	1.5	V
$V_{I(on)}$	on-state input voltage	$V_{CE} = 0.3\text{ V}; I_C = 20\text{ mA}$				
	PDTD113EU		1.0	1.4	1.8	V
	PDTD113ZU		0.4	0.8	1.4	V
	PDTD123EU		1.0	1.5	2.0	V
	PDTD123YU		0.5	1.0	1.4	V
	PDTD143EU		1.0	1.6	2.2	V
	PDTD143XU		1.0	1.25	2.0	V
	PDTD114EU		1.0	1.9	3.0	V

**Table 8. Characteristics ...continued**  
 $T_{amb} = 25\text{ }^{\circ}\text{C}$  unless otherwise specified.

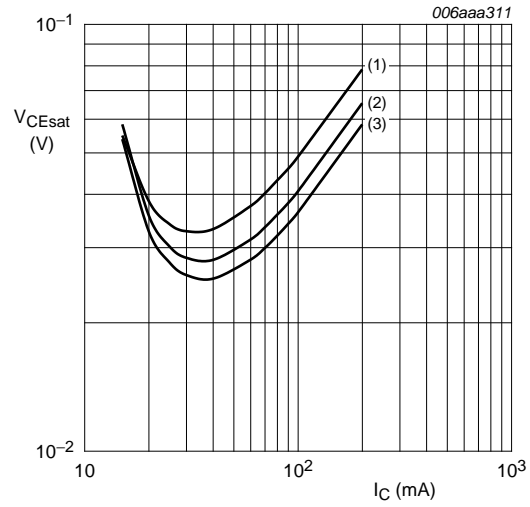
Symbol	Parameter	Conditions	Min	Typ	Max	Unit
R1	bias resistor 1 (input)					
	PDTD113EU		0.7	1.0	1.3	k $\Omega$
	PDTD113ZU		0.7	1.0	1.3	k $\Omega$
	PDTD123EU		1.54	2.2	2.86	k $\Omega$
	PDTD123YU		1.54	2.2	2.86	k $\Omega$
	PDTD143EU		3.3	4.7	6.1	k $\Omega$
	PDTD143XU		3.3	4.7	6.1	k $\Omega$
	PDTD114EU		7.0	10	13	k $\Omega$
R2/R1	bias resistor ratio					
	PDTD113EU		0.9	1.0	1.1	
	PDTD113ZU		9.0	10	11	
	PDTD123EU		0.9	1.0	1.1	
	PDTD123YU		4.1	4.55	5.0	
	PDTD143EU		0.9	1	1.1	
	PDTD143XU		1.91	2.13	2.34	
	PDTD114EU		0.9	1.0	1.1	
C <sub>c</sub>	collector capacitance	V <sub>CB</sub> = 10 V; I <sub>E</sub> = i <sub>e</sub> = 0 A; f = 1 MHz	-	7	-	pF
f <sub>T</sub>	transition frequency	V <sub>CE</sub> = 5 V; I <sub>C</sub> = 50 mA; f = 100 MHz	[1]	225	-	MHz

[1] Characteristics of built-in transistor.



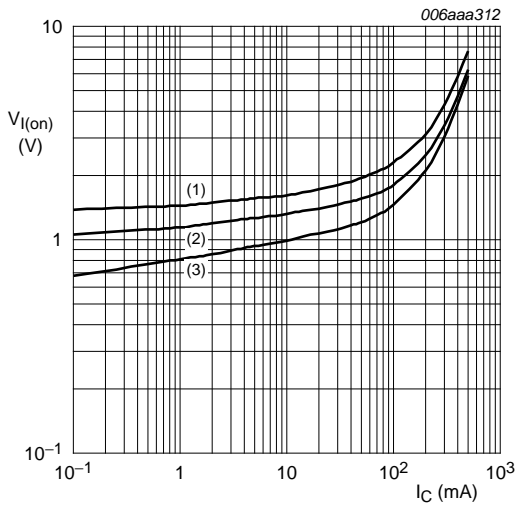
$V_{CE} = 5 \text{ V}$   
 (1)  $T_{amb} = 100 \text{ }^\circ\text{C}$   
 (2)  $T_{amb} = 25 \text{ }^\circ\text{C}$   
 (3)  $T_{amb} = -40 \text{ }^\circ\text{C}$

**Fig 4. PDTD113EU: DC current gain as a function of collector current; typical values**



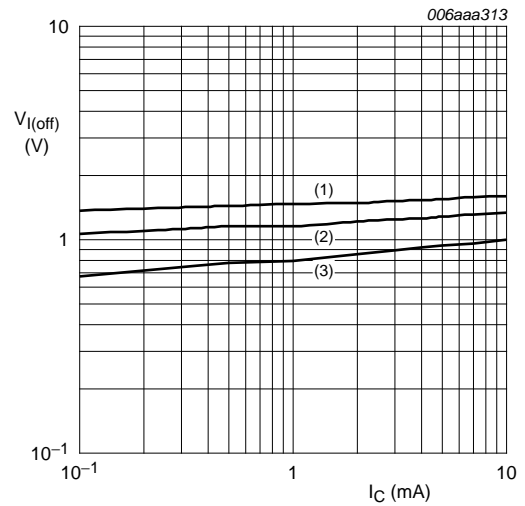
$I_C/I_B = 20$   
 (1)  $T_{amb} = 100 \text{ }^\circ\text{C}$   
 (2)  $T_{amb} = 25 \text{ }^\circ\text{C}$   
 (3)  $T_{amb} = -40 \text{ }^\circ\text{C}$

**Fig 5. PDTD113EU: Collector-emitter saturation voltage as a function of collector current; typical values**



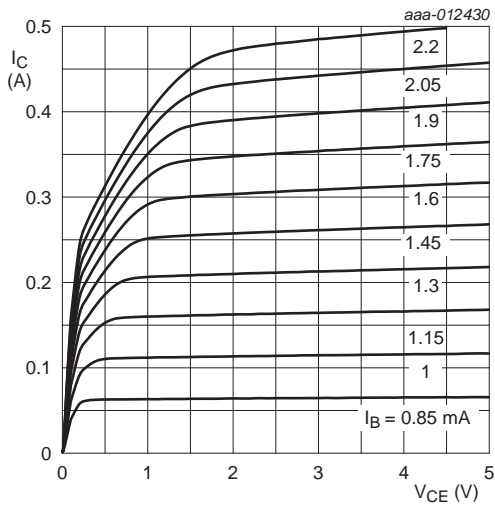
$V_{CE} = 0.3 \text{ V}$   
 (1)  $T_{amb} = -40 \text{ }^\circ\text{C}$   
 (2)  $T_{amb} = 25 \text{ }^\circ\text{C}$   
 (3)  $T_{amb} = 100 \text{ }^\circ\text{C}$

**Fig 6. PDTD113EU: On-state input voltage as a function of collector current; typical values**



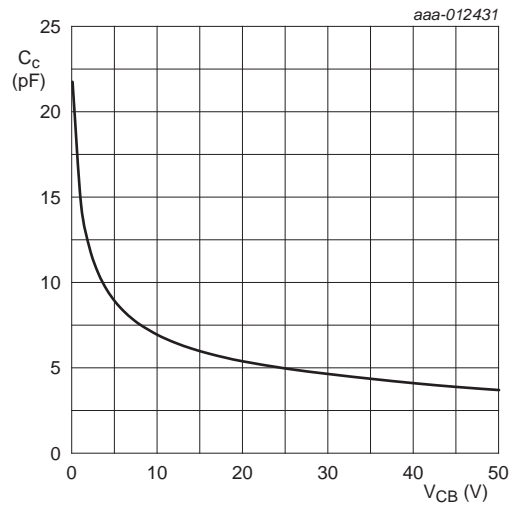
$V_{CE} = 5 \text{ V}$   
 (1)  $T_{amb} = -40 \text{ }^\circ\text{C}$   
 (2)  $T_{amb} = 25 \text{ }^\circ\text{C}$   
 (3)  $T_{amb} = 100 \text{ }^\circ\text{C}$

**Fig 7. PDTD113EU: Off-state input voltage as a function of collector current; typical values**



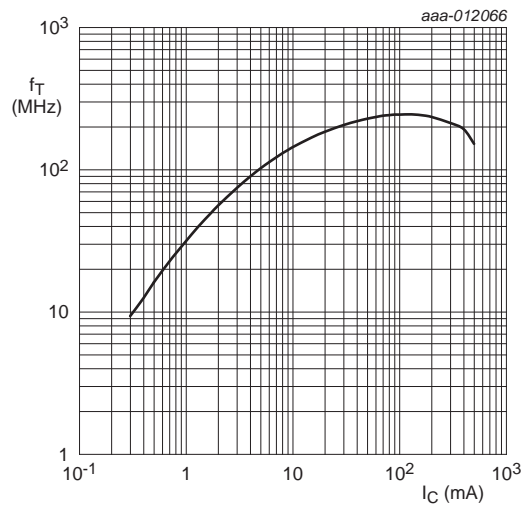
$T_{amb} = 25\text{ }^\circ\text{C}$

**Fig 8. PDTD113EU: Collector current as a function of collector-emitter voltage; typical values**



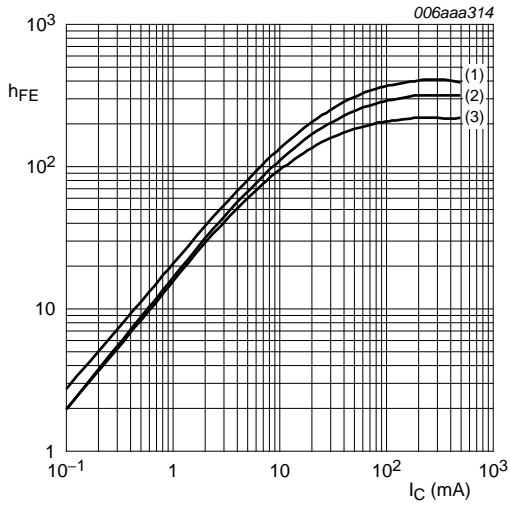
$f = 1\text{ MHz}; T_{amb} = 25\text{ }^\circ\text{C}$

**Fig 9. PDTD113EU: Collector capacitance as a function of collector-base voltage; typical values**



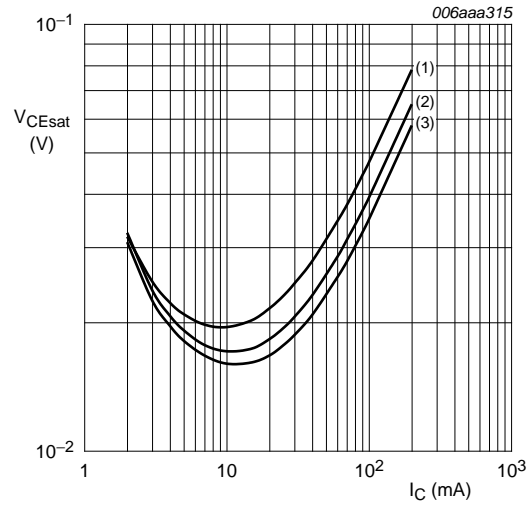
$V_{CE} = 5\text{ V}; T_{amb} = 25\text{ }^\circ\text{C}$

**Fig 10. PDTD113EU: Transition frequency as a function of collector current; typical values of built-in transistor**



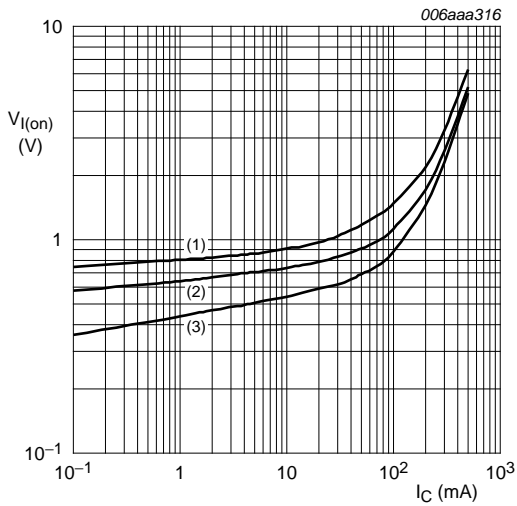
$V_{CE} = 5 \text{ V}$   
 (1)  $T_{amb} = 100 \text{ }^\circ\text{C}$   
 (2)  $T_{amb} = 25 \text{ }^\circ\text{C}$   
 (3)  $T_{amb} = -40 \text{ }^\circ\text{C}$

**Fig 11. PDTD113ZU: DC current gain as a function of collector current; typical values**



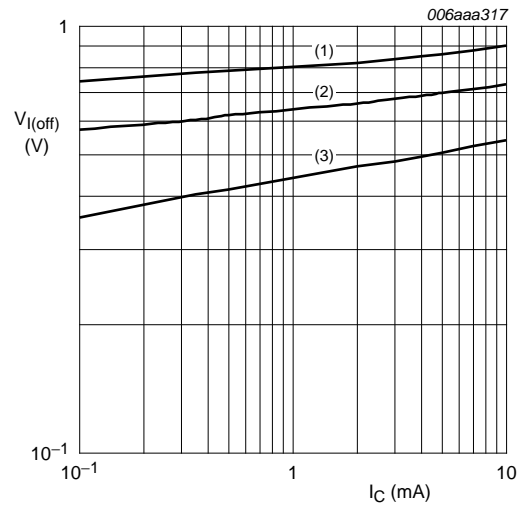
$I_C/I_B = 20$   
 (1)  $T_{amb} = 100 \text{ }^\circ\text{C}$   
 (2)  $T_{amb} = 25 \text{ }^\circ\text{C}$   
 (3)  $T_{amb} = -40 \text{ }^\circ\text{C}$

**Fig 12. PDTD113ZU: Collector-emitter saturation voltage as a function of collector current; typical values**



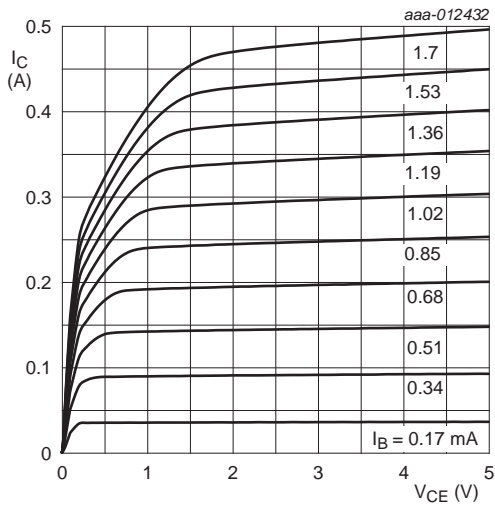
$V_{CE} = 0.3 \text{ V}$   
 (1)  $T_{amb} = -40 \text{ }^\circ\text{C}$   
 (2)  $T_{amb} = 25 \text{ }^\circ\text{C}$   
 (3)  $T_{amb} = 100 \text{ }^\circ\text{C}$

**Fig 13. PDTD113ZU: On-state input voltage as a function of collector current; typical values**



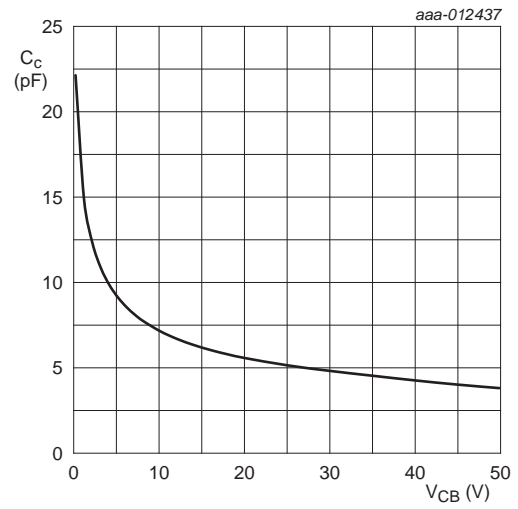
$V_{CE} = 5 \text{ V}$   
 (1)  $T_{amb} = -40 \text{ }^\circ\text{C}$   
 (2)  $T_{amb} = 25 \text{ }^\circ\text{C}$   
 (3)  $T_{amb} = 100 \text{ }^\circ\text{C}$

**Fig 14. PDTD113ZU: Off-state input voltage as a function of collector current; typical values**



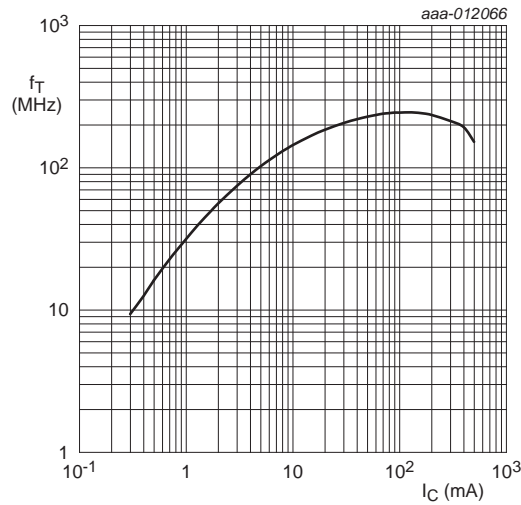
$T_{amb} = 25\text{ }^\circ\text{C}$

Fig 15. PDTD113ZU: Collector current as a function of collector-emitter voltage; typical values



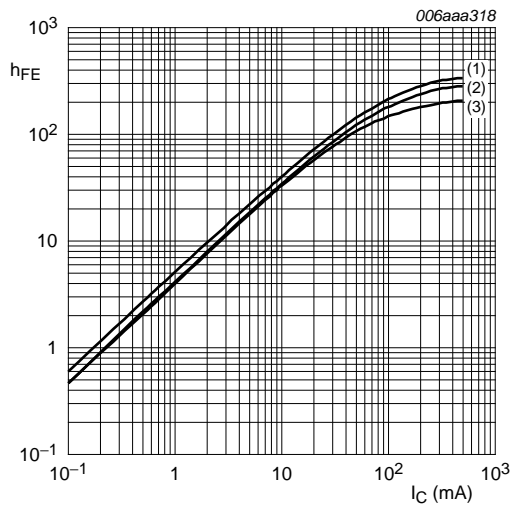
$f = 1\text{ MHz}; T_{amb} = 25\text{ }^\circ\text{C}$

Fig 16. PDTD113ZU: Collector capacitance as a function of collector-base voltage; typical values



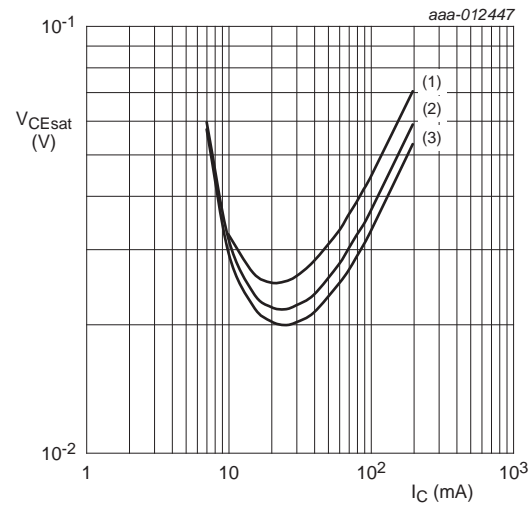
$V_{CE} = 5\text{ V}; T_{amb} = 25\text{ }^\circ\text{C}$

Fig 17. PDTD113ZU: Transition frequency as a function of collector current; typical values of built-in transistor



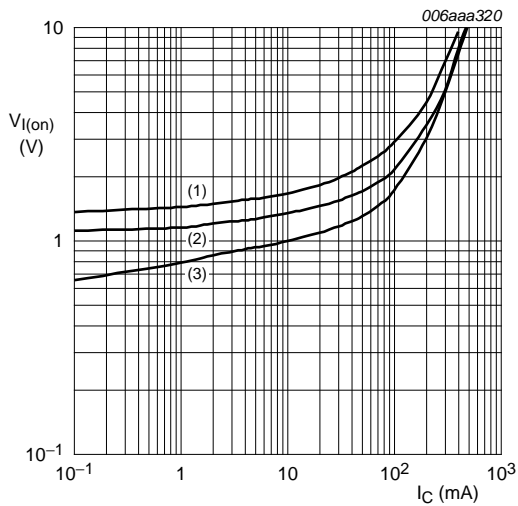
$V_{CE} = 5 \text{ V}$   
 (1)  $T_{amb} = 100 \text{ }^\circ\text{C}$   
 (2)  $T_{amb} = 25 \text{ }^\circ\text{C}$   
 (3)  $T_{amb} = -40 \text{ }^\circ\text{C}$

**Fig 18. PDTD123EU: DC current gain as a function of collector current; typical values**



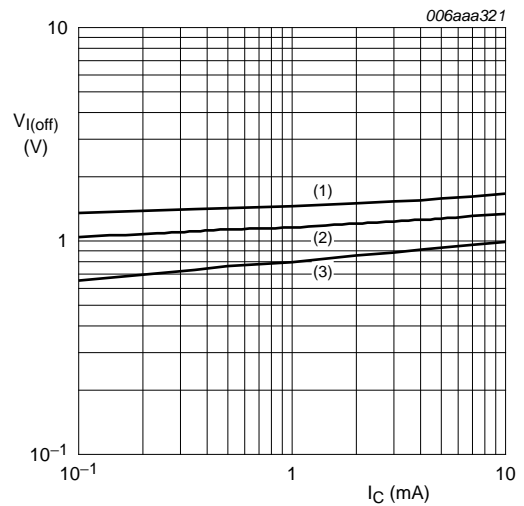
$I_C/I_B = 20$   
 (1)  $T_{amb} = 100 \text{ }^\circ\text{C}$   
 (2)  $T_{amb} = 25 \text{ }^\circ\text{C}$   
 (3)  $T_{amb} = -40 \text{ }^\circ\text{C}$

**Fig 19. PDTD123EU: Collector-emitter saturation voltage as a function of collector current; typical values**



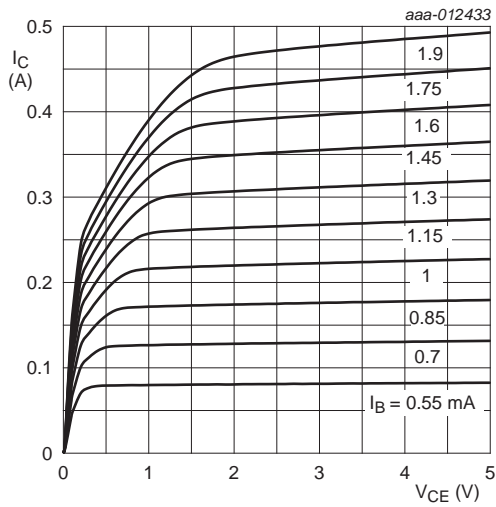
$V_{CE} = 0.3 \text{ V}$   
 (1)  $T_{amb} = -40 \text{ }^\circ\text{C}$   
 (2)  $T_{amb} = 25 \text{ }^\circ\text{C}$   
 (3)  $T_{amb} = 100 \text{ }^\circ\text{C}$

**Fig 20. PDTD123EU: On-state input voltage as a function of collector current; typical values**



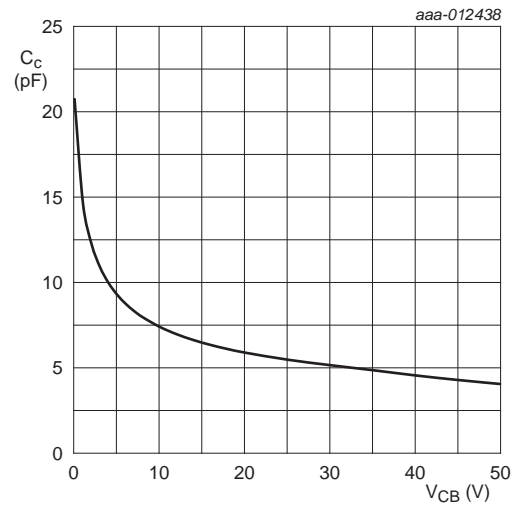
$V_{CE} = 5 \text{ V}$   
 (1)  $T_{amb} = -40 \text{ }^\circ\text{C}$   
 (2)  $T_{amb} = 25 \text{ }^\circ\text{C}$   
 (3)  $T_{amb} = 100 \text{ }^\circ\text{C}$

**Fig 21. PDTD123EU: Off-state input voltage as a function of collector current; typical values**



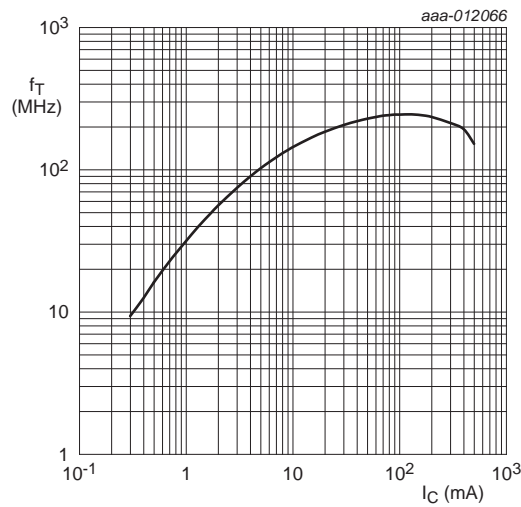
$T_{amb} = 25\text{ }^\circ\text{C}$

**Fig 22. PDTD123EU: Collector current as a function of collector-emitter voltage; typical values**



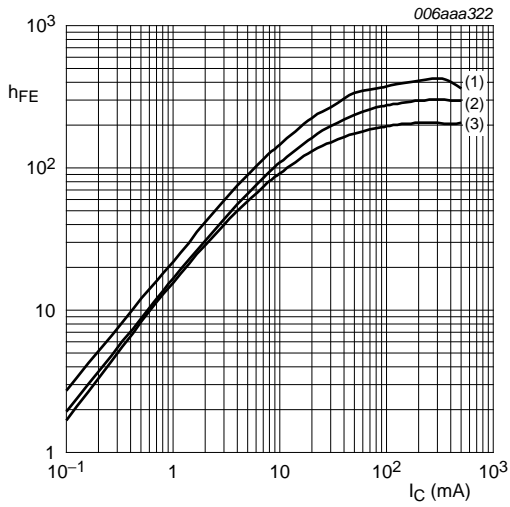
$f = 1\text{ MHz}; T_{amb} = 25\text{ }^\circ\text{C}$

**Fig 23. PDTD123EU: Collector capacitance as a function of collector-base voltage; typical values**



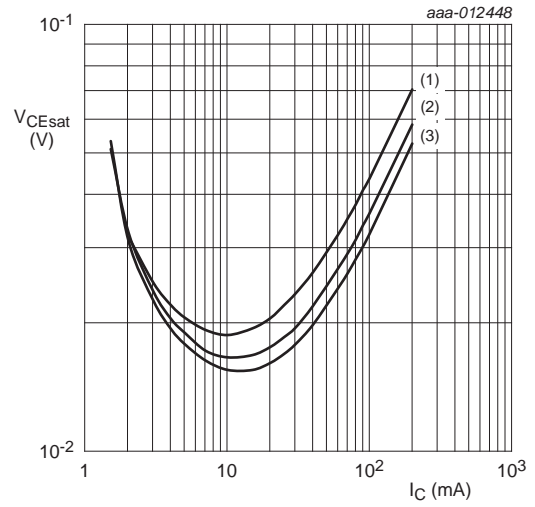
$V_{CE} = 5\text{ V}; T_{amb} = 25\text{ }^\circ\text{C}$

**Fig 24. PDTD123EU: Transition frequency as a function of collector current; typical values of built-in transistor**



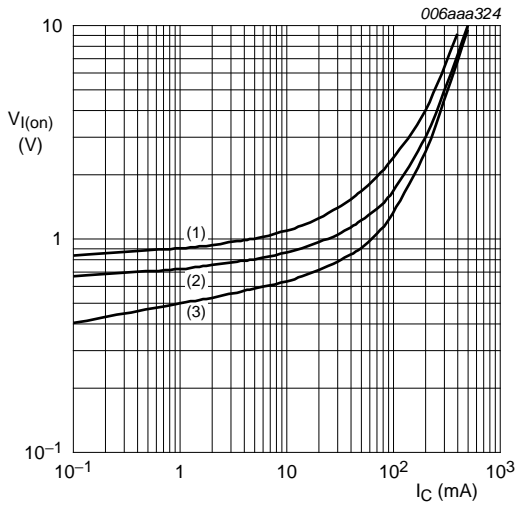
$V_{CE} = 5 \text{ V}$   
 (1)  $T_{amb} = 100 \text{ }^\circ\text{C}$   
 (2)  $T_{amb} = 25 \text{ }^\circ\text{C}$   
 (3)  $T_{amb} = -40 \text{ }^\circ\text{C}$

**Fig 25. PDTD123YU: DC current gain as a function of collector current; typical values**



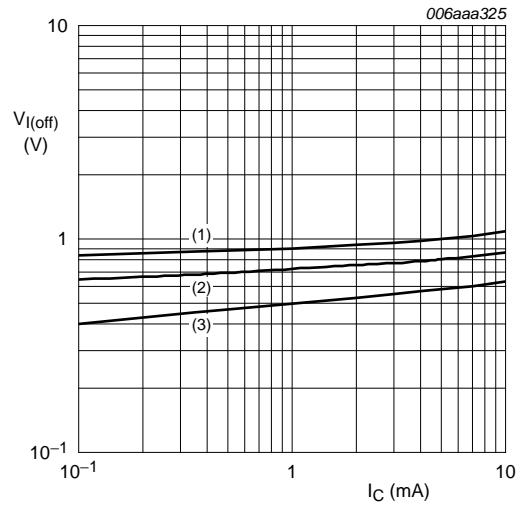
$I_C/I_B = 20$   
 (1)  $T_{amb} = 100 \text{ }^\circ\text{C}$   
 (2)  $T_{amb} = 25 \text{ }^\circ\text{C}$   
 (3)  $T_{amb} = -40 \text{ }^\circ\text{C}$

**Fig 26. PDTD123YU: Collector-emitter saturation voltage as a function of collector current; typical values**



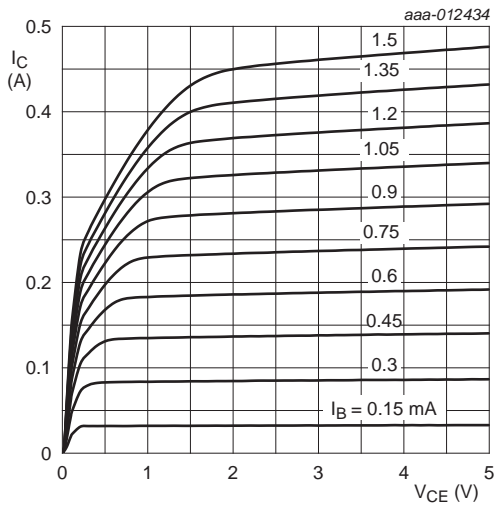
$V_{CE} = 0.3 \text{ V}$   
 (1)  $T_{amb} = -40 \text{ }^\circ\text{C}$   
 (2)  $T_{amb} = 25 \text{ }^\circ\text{C}$   
 (3)  $T_{amb} = 100 \text{ }^\circ\text{C}$

**Fig 27. PDTD123YU: On-state input voltage as a function of collector current; typical values**

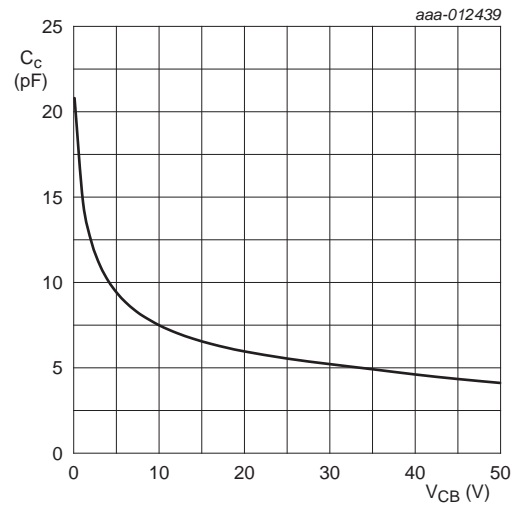


$V_{CE} = 5 \text{ V}$   
 (1)  $T_{amb} = -40 \text{ }^\circ\text{C}$   
 (2)  $T_{amb} = 25 \text{ }^\circ\text{C}$   
 (3)  $T_{amb} = 100 \text{ }^\circ\text{C}$

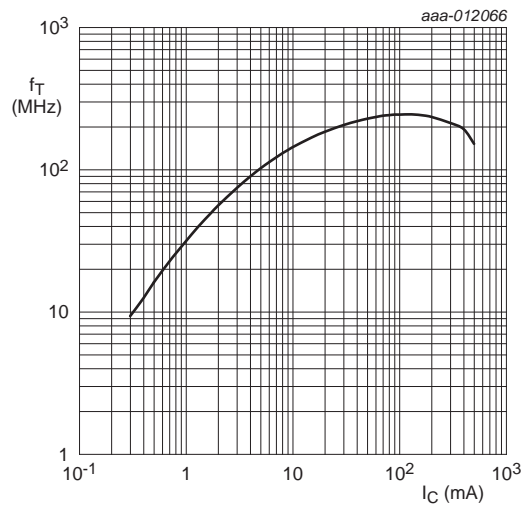
**Fig 28. PDTD123YU: Off-state input voltage as a function of collector current; typical values**



**Fig 29. PDTD123YU: Collector current as a function of collector-emitter voltage; typical values**

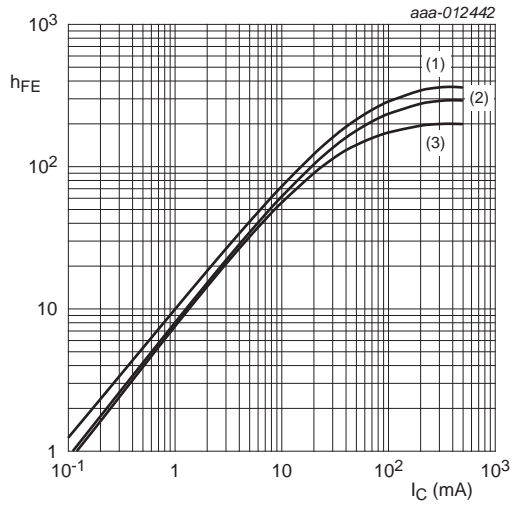


**Fig 30. PDTD123YU: Collector capacitance as a function of collector-base voltage; typical values**



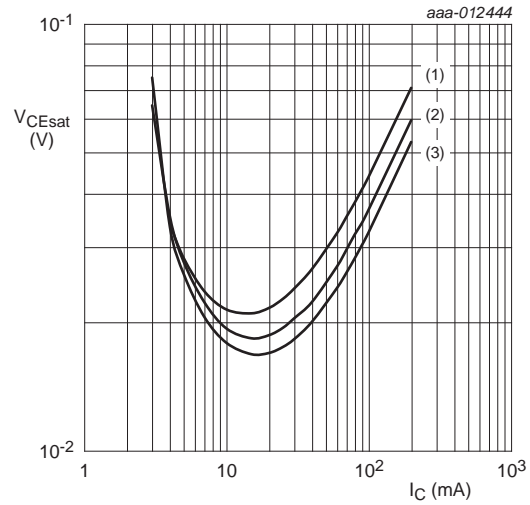
$V_{CE} = 5\text{ V}; T_{amb} = 25^\circ\text{C}$

**Fig 31. PDTD123YU: Transition frequency as a function of collector current; typical values of built-in transistor**



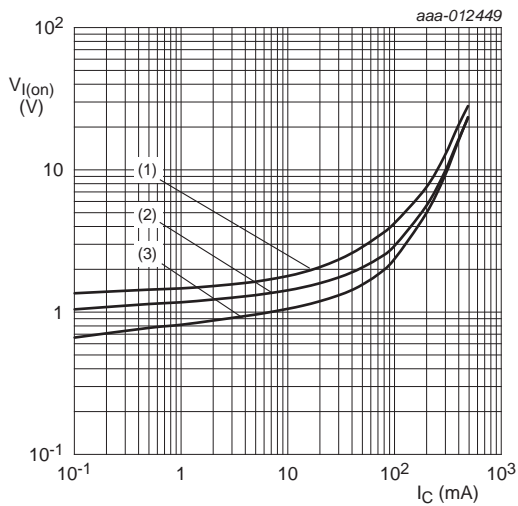
$V_{CE} = 5 \text{ V}$   
 (1)  $T_{amb} = 100 \text{ }^\circ\text{C}$   
 (2)  $T_{amb} = 25 \text{ }^\circ\text{C}$   
 (3)  $T_{amb} = -40 \text{ }^\circ\text{C}$

**Fig 32. PDTD143EU: DC current gain as a function of collector current; typical values**



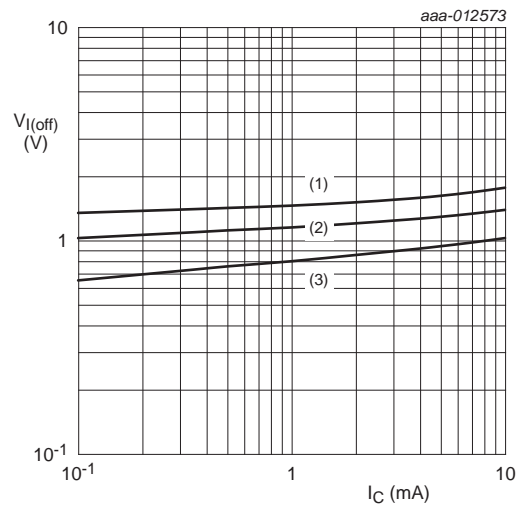
$I_C/I_B = 20$   
 (1)  $T_{amb} = 100 \text{ }^\circ\text{C}$   
 (2)  $T_{amb} = 25 \text{ }^\circ\text{C}$   
 (3)  $T_{amb} = -40 \text{ }^\circ\text{C}$

**Fig 33. PDTD143EU: Collector-emitter saturation voltage as a function of collector current; typical values**



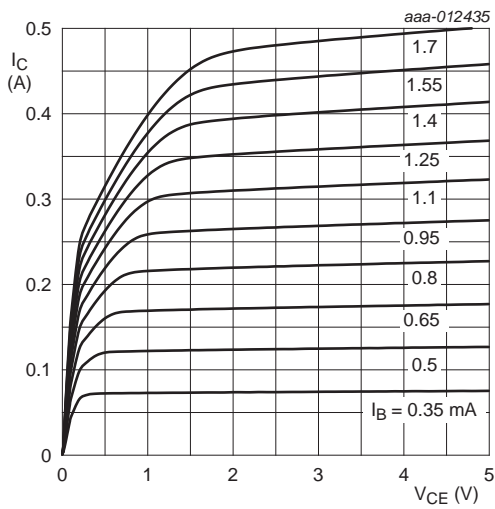
$V_{CE} = 0.3 \text{ V}$   
 (1)  $T_{amb} = -40 \text{ }^\circ\text{C}$   
 (2)  $T_{amb} = 25 \text{ }^\circ\text{C}$   
 (3)  $T_{amb} = 100 \text{ }^\circ\text{C}$

**Fig 34. PDTD143EU: On-state input voltage as a function of collector current; typical values**



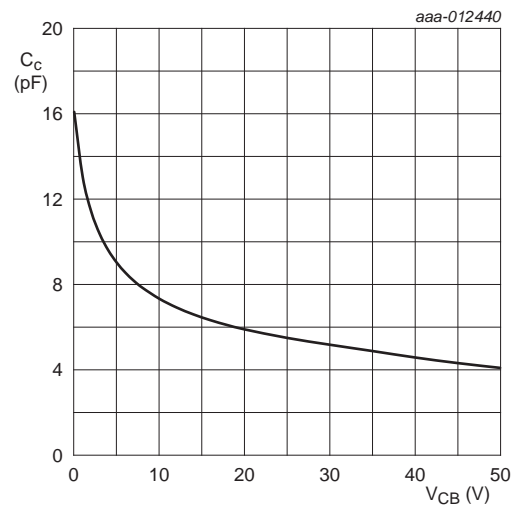
$V_{CE} = 5 \text{ V}$   
 (1)  $T_{amb} = -40 \text{ }^\circ\text{C}$   
 (2)  $T_{amb} = 25 \text{ }^\circ\text{C}$   
 (3)  $T_{amb} = 100 \text{ }^\circ\text{C}$

**Fig 35. PDTD143EU: Off-state input voltage as a function of collector current; typical values**



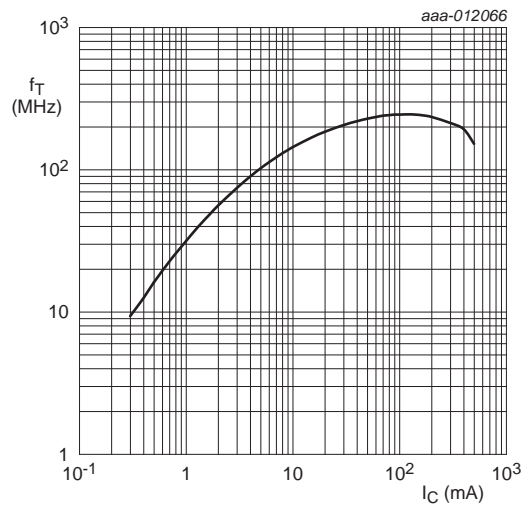
$T_{amb} = 25\text{ }^\circ\text{C}$

**Fig 36. PDTD143EU: Collector current as a function of collector-emitter voltage; typical values**



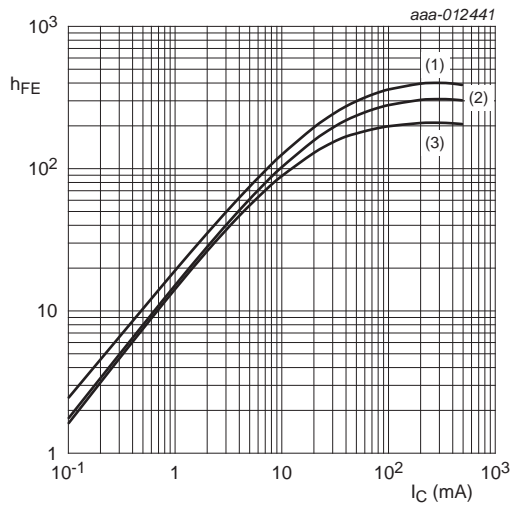
$f = 1\text{ MHz}; T_{amb} = 25\text{ }^\circ\text{C}$

**Fig 37. PDTD143EU: Collector capacitance as a function of collector-base voltage; typical values**



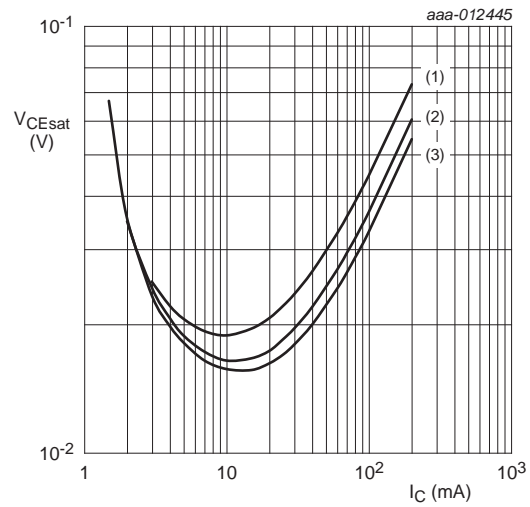
$V_{CE} = 5\text{ V}; T_{amb} = 25\text{ }^\circ\text{C}$

**Fig 38. PDTD143EU: Transition frequency as a function of collector current; typical values of built-in transistor**



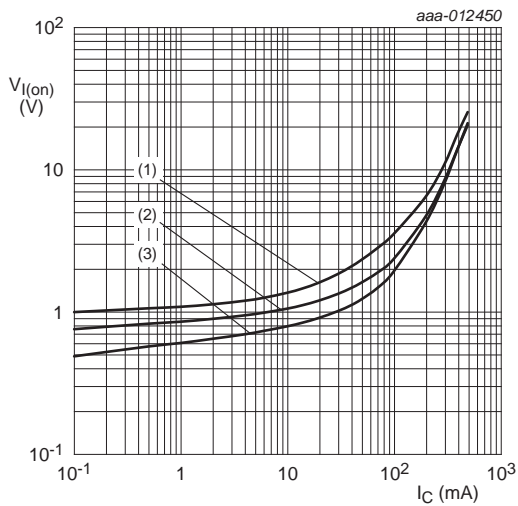
$V_{CE} = 5\text{ V}$   
 (1)  $T_{amb} = 100\text{ }^{\circ}\text{C}$   
 (2)  $T_{amb} = 25\text{ }^{\circ}\text{C}$   
 (3)  $T_{amb} = -40\text{ }^{\circ}\text{C}$

**Fig 39. PDTD143XU: DC current gain as a function of collector current; typical values**



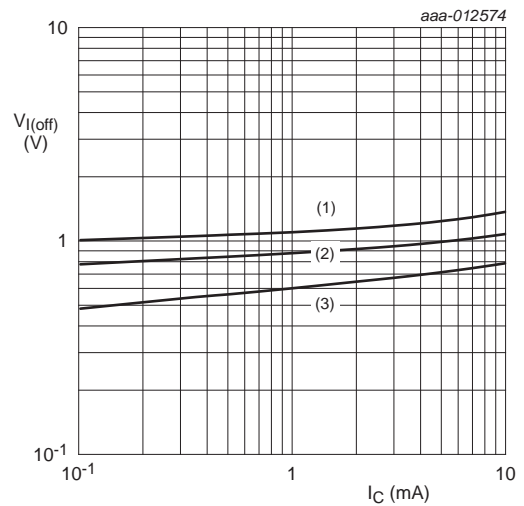
$I_C/I_B = 20$   
 (1)  $T_{amb} = 100\text{ }^{\circ}\text{C}$   
 (2)  $T_{amb} = 25\text{ }^{\circ}\text{C}$   
 (3)  $T_{amb} = -40\text{ }^{\circ}\text{C}$

**Fig 40. PDTD143XU: Collector-emitter saturation voltage as a function of collector current; typical values**



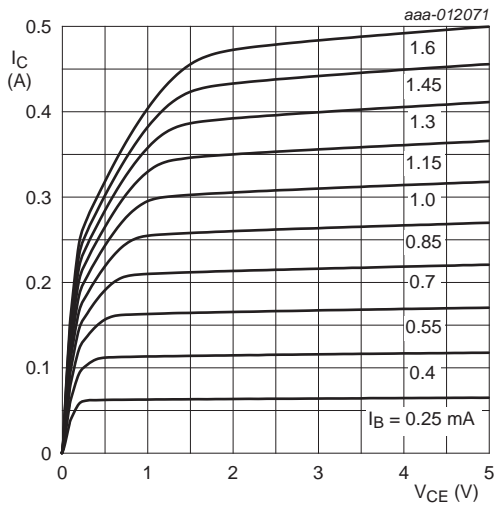
$V_{CE} = 0.3\text{ V}$   
 (1)  $T_{amb} = -40\text{ }^{\circ}\text{C}$   
 (2)  $T_{amb} = 25\text{ }^{\circ}\text{C}$   
 (3)  $T_{amb} = 100\text{ }^{\circ}\text{C}$

**Fig 41. PDTD143XU: On-state input voltage as a function of collector current; typical values**



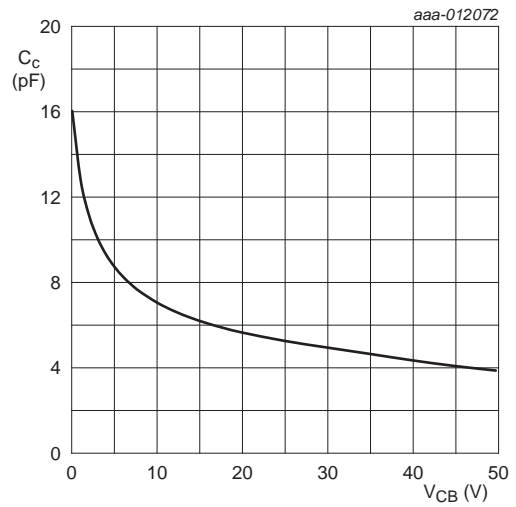
$V_{CE} = 5\text{ V}$   
 (1)  $T_{amb} = -40\text{ }^{\circ}\text{C}$   
 (2)  $T_{amb} = 25\text{ }^{\circ}\text{C}$   
 (3)  $T_{amb} = 100\text{ }^{\circ}\text{C}$

**Fig 42. PDTD143XU: Off-state input voltage as a function of collector current; typical values**



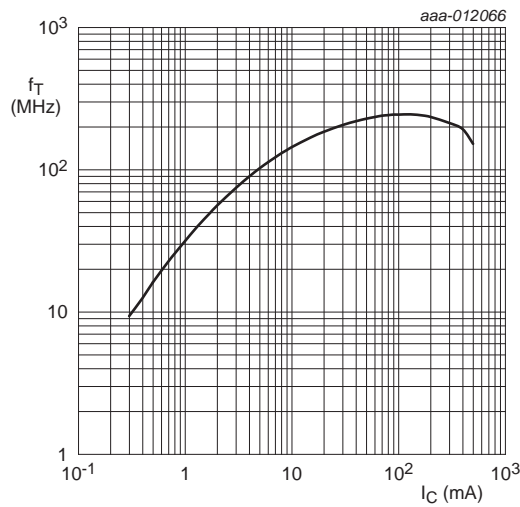
$T_{amb} = 25\text{ }^\circ\text{C}$

**Fig 43. PDTD143XU: Collector current as a function of collector-emitter voltage; typical values**



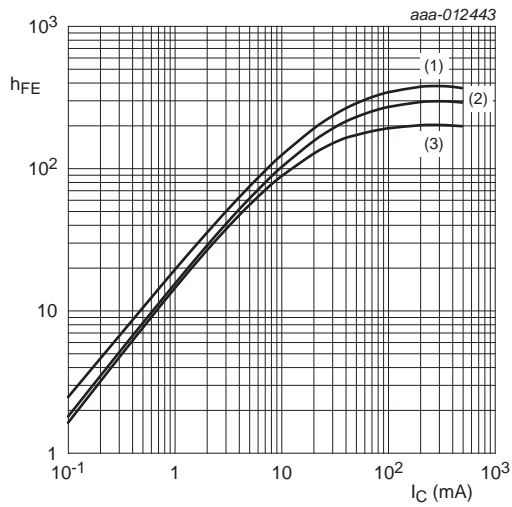
$f = 1$  MHz;  $T_{amb} = 25\text{ }^\circ\text{C}$

**Fig 44. PDTD143XU: Collector capacitance as a function of collector-base voltage; typical values**



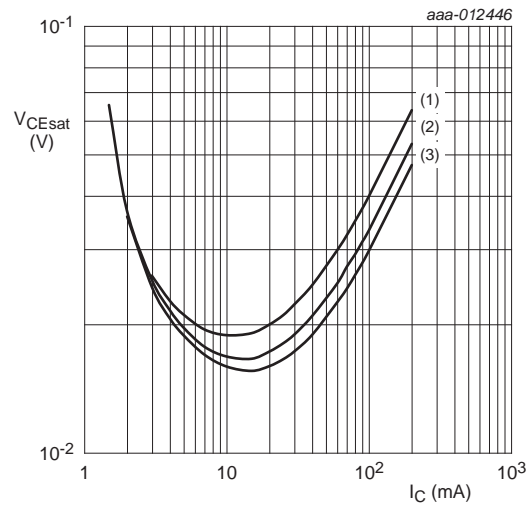
$V_{CE} = 5$  V;  $T_{amb} = 25\text{ }^\circ\text{C}$

**Fig 45. PDTD143XU: Transition frequency as a function of collector current; typical values of built-in transistor**



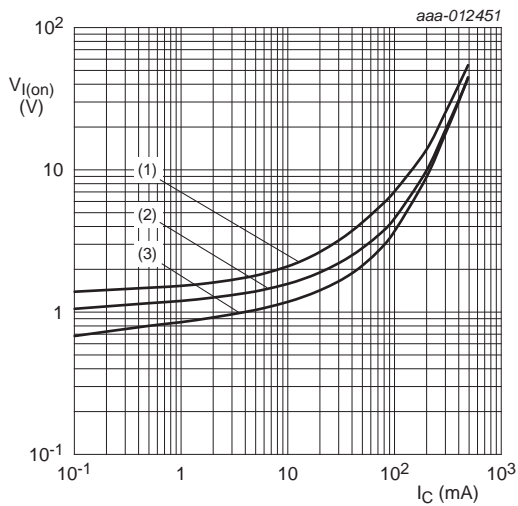
$V_{CE} = 5 \text{ V}$   
 (1)  $T_{amb} = 100 \text{ }^\circ\text{C}$   
 (2)  $T_{amb} = 25 \text{ }^\circ\text{C}$   
 (3)  $T_{amb} = -40 \text{ }^\circ\text{C}$

**Fig 46. PDTD114EU: DC current gain as a function of collector current; typical values**



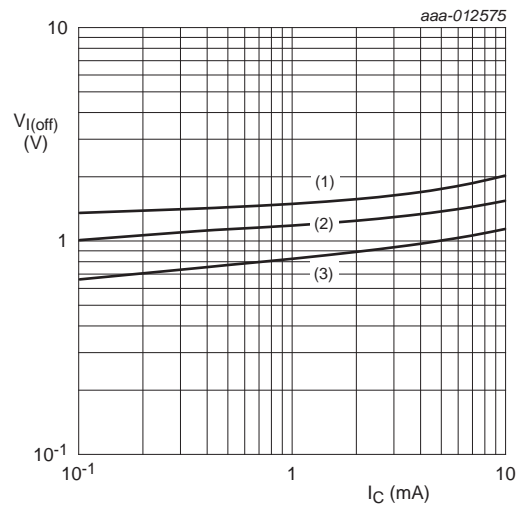
$I_C/I_B = 20$   
 (1)  $T_{amb} = 100 \text{ }^\circ\text{C}$   
 (2)  $T_{amb} = 25 \text{ }^\circ\text{C}$   
 (3)  $T_{amb} = -40 \text{ }^\circ\text{C}$

**Fig 47. PDTD114EU: Collector-emitter saturation voltage as a function of collector current; typical values**



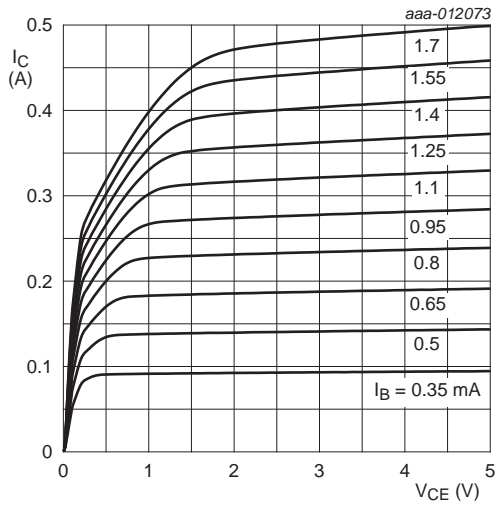
$V_{CE} = 0.3 \text{ V}$   
 (1)  $T_{amb} = -40 \text{ }^\circ\text{C}$   
 (2)  $T_{amb} = 25 \text{ }^\circ\text{C}$   
 (3)  $T_{amb} = 100 \text{ }^\circ\text{C}$

**Fig 48. PDTD114EU: On-state input voltage as a function of collector current; typical values**



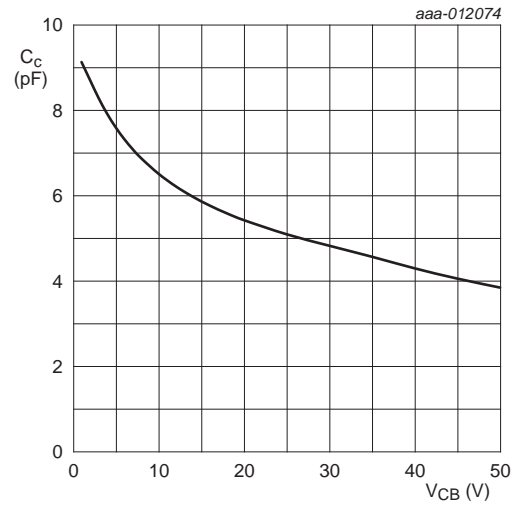
$V_{CE} = 5 \text{ V}$   
 (1)  $T_{amb} = -40 \text{ }^\circ\text{C}$   
 (2)  $T_{amb} = 25 \text{ }^\circ\text{C}$   
 (3)  $T_{amb} = 100 \text{ }^\circ\text{C}$

**Fig 49. PDTD114EU: Off-state input voltage as a function of collector current; typical values**



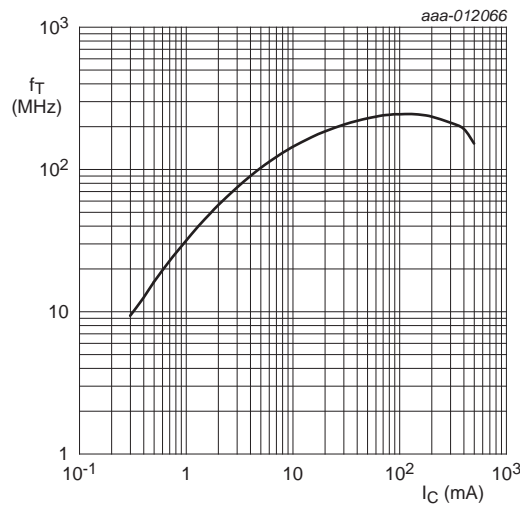
$T_{amb} = 25^\circ\text{C}$

**Fig 50. PDTD114EU: Collector current as a function of collector-emitter voltage; typical values**



$f = 1$  MHz;  $T_{amb} = 25^\circ\text{C}$

**Fig 51. PDTD114EU: Collector capacitance as a function of collector-base voltage; typical values**



$V_{CE} = 5$  V;  $T_{amb} = 25^\circ\text{C}$

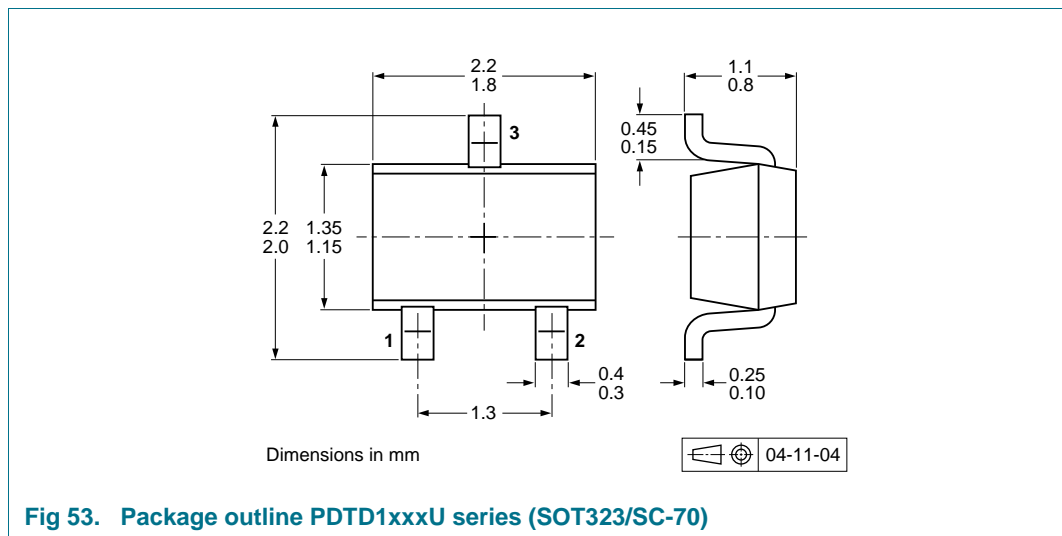
**Fig 52. PDTD114EU: Transition frequency as a function of collector current; typical values of built-in transistor**

## 8. Test information

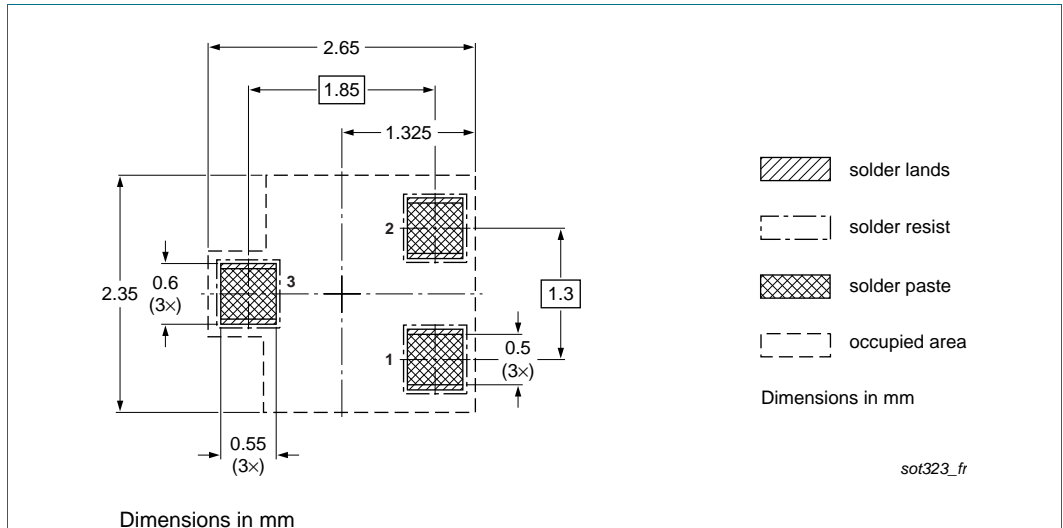
### 8.1 Quality information

This product has been qualified in accordance with the Automotive Electronics Council (AEC) standard *Q101 - Stress test qualification for discrete semiconductors*, and is suitable for use in automotive applications.

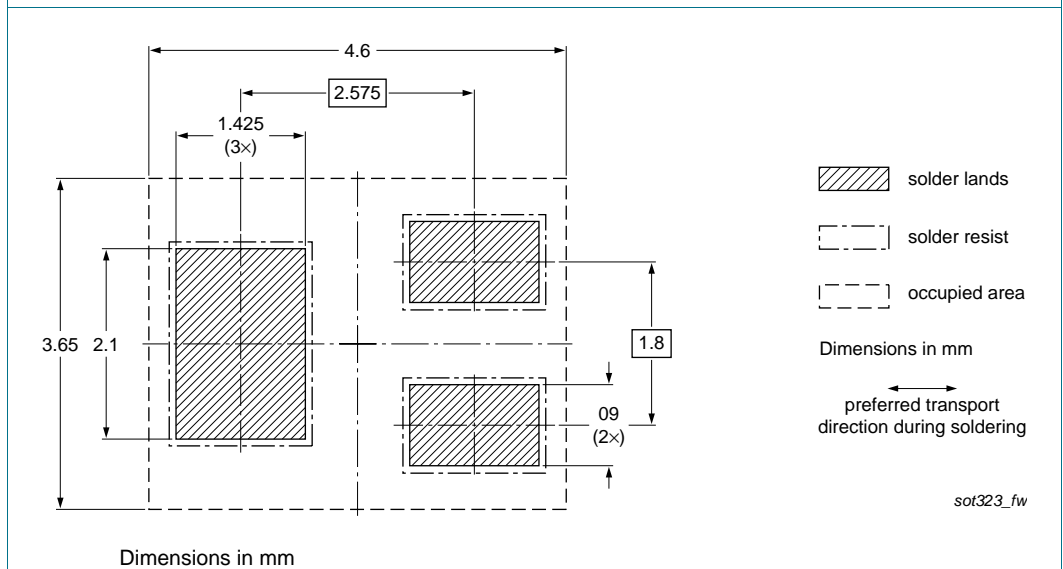
## 9. Package outline



**10. Soldering**



**Fig 54. Reflow soldering footprint PDTD1xxxU series (SOT323/SC-70)**



**Fig 55. Wave soldering footprint PDTD1xxxU series (SOT323/SC-70)**

## 11. Revision history

Table 9. Revision history

Document ID	Release date	Data sheet status	Change notice	Supersedes
PDTD1XXXU_SER v.1	20140513	Product data sheet	-	-

## 12. Legal information

### 12.1 Data sheet status

Document status <sup>[1][2]</sup>	Product status <sup>[3]</sup>	Definition
Objective [short] data sheet	Development	This document contains data from the objective specification for product development.
Preliminary [short] data sheet	Qualification	This document contains data from the preliminary specification.
Product [short] data sheet	Production	This document contains the product specification.

[1] Please consult the most recently issued document before initiating or completing a design.

[2] The term 'short data sheet' is explained in section "Definitions".

[3] The product status of device(s) described in this document may have changed since this document was published and may differ in case of multiple devices. The latest product status information is available on the Internet at URL <http://www.nexperia.com>.

### 12.2 Definitions

**Draft** — The document is a draft version only. The content is still under internal review and subject to formal approval, which may result in modifications or additions. Nexperia does not give any representations or warranties as to the accuracy or completeness of information included herein and shall have no liability for the consequences of use of such information.

**Short data sheet** — A short data sheet is an extract from a full data sheet with the same product type number(s) and title. A short data sheet is intended for quick reference only and should not be relied upon to contain detailed and full information. For detailed and full information see the relevant full data sheet, which is available on request via the local Nexperia sales office. In case of any inconsistency or conflict with the short data sheet, the full data sheet shall prevail.

**Product specification** — The information and data provided in a Product data sheet shall define the specification of the product as agreed between Nexperia and its customer, unless Nexperia and customer have explicitly agreed otherwise in writing. In no event however, shall an agreement be valid in which the Nexperia product is deemed to offer functions and qualities beyond those described in the Product data sheet.

### 12.3 Disclaimers

**Limited warranty and liability** — Information in this document is believed to be accurate and reliable. However, Nexperia does not give any representations or warranties, expressed or implied, as to the accuracy or completeness of such information and shall have no liability for the consequences of use of such information. Nexperia takes no responsibility for the content in this document if provided by an information source outside of Nexperia.

In no event shall Nexperia be liable for any indirect, incidental, punitive, special or consequential damages (including - without limitation - lost profits, lost savings, business interruption, costs related to the removal or replacement of any products or rework charges) whether or not such damages are based on tort (including negligence), warranty, breach of contract or any other legal theory.

Notwithstanding any damages that customer might incur for any reason whatsoever, Nexperia's aggregate and cumulative liability towards customer for the products described herein shall be limited in accordance with the *Terms and conditions of commercial sale* of Nexperia.

**Right to make changes** — Nexperia reserves the right to make changes to information published in this document, including without limitation specifications and product descriptions, at any time and without notice. This document supersedes and replaces all information supplied prior to the publication hereof.

**Suitability for use in automotive applications** — This Nexperia product has been qualified for use in automotive applications. Unless otherwise agreed in writing, the product is not designed, authorized or warranted to be suitable for use in life support, life-critical or safety-critical systems or equipment, nor in applications where failure or malfunction of a Nexperia product can reasonably be expected to result in personal injury, death or severe property or environmental damage. Nexperia and its suppliers accept no liability for inclusion and/or use of Nexperia products in such equipment or applications and therefore such inclusion and/or use is at the customer's own risk.

**Applications** — Applications that are described herein for any of these products are for illustrative purposes only. Nexperia makes no representation or warranty that such applications will be suitable for the specified use without further testing or modification.

Customers are responsible for the design and operation of their applications and products using Nexperia products, and Nexperia accepts no liability for any assistance with applications or customer product design. It is customer's sole responsibility to determine whether the Nexperia product is suitable and fit for the customer's applications and products planned, as well as for the planned application and use of customer's third party customer(s). Customers should provide appropriate design and operating safeguards to minimize the risks associated with their applications and products.

Nexperia does not accept any liability related to any default, damage, costs or problem which is based on any weakness or default in the customer's applications or products, or the application or use by customer's third party customer(s). Customer is responsible for doing all necessary testing for the customer's applications and products using Nexperia products in order to avoid a default of the applications and the products or of the application or use by customer's third party customer(s). Nexperia does not accept any liability in this respect.

**Limiting values** — Stress above one or more limiting values (as defined in the Absolute Maximum Ratings System of IEC 60134) will cause permanent damage to the device. Limiting values are stress ratings only and (proper) operation of the device at these or any other conditions above those given in the Recommended operating conditions section (if present) or the Characteristics sections of this document is not warranted. Constant or repeated exposure to limiting values will permanently and irreversibly affect the quality and reliability of the device.

**Terms and conditions of commercial sale** — Nexperia products are sold subject to the general terms and conditions of commercial sale, as published at <http://www.nexperia.com/profile/terms> unless otherwise agreed in a valid written individual agreement. In case an individual agreement is concluded only the terms and conditions of the respective agreement shall apply. Nexperia hereby expressly objects to applying the customer's general terms and conditions with regard to the purchase of Nexperia products by customer.

**No offer to sell or license** — Nothing in this document may be interpreted or construed as an offer to sell products that is open for acceptance or the grant, conveyance or implication of any license under any copyrights, patents or other industrial or intellectual property rights.

**Export control** — This document as well as the item(s) described herein may be subject to export control regulations. Export might require a prior authorization from competent authorities.

**Quick reference data** — The Quick reference data is an extract of the product data given in the Limiting values and Characteristics sections of this document, and as such is not complete, exhaustive or legally binding.

**Translations** — A non-English (translated) version of a document is for reference only. The English version shall prevail in case of any discrepancy between the translated and English versions.

## 12.4 Trademarks

Notice: All referenced brands, product names, service names and trademarks are the property of their respective owners.

## 13. Contact information

---

For more information, please visit: <http://www.nexperia.com>

For sales office addresses, please send an email to: [salesaddresses@nexperia.com](mailto:salesaddresses@nexperia.com)

## 14. Contents

---

<b>1</b>	<b>Product profile</b> . . . . .	<b>1</b>
1.1	General description . . . . .	1
1.2	Features . . . . .	1
1.3	Applications . . . . .	1
1.4	Quick reference data . . . . .	2
<b>2</b>	<b>Pinning information</b> . . . . .	<b>2</b>
<b>3</b>	<b>Ordering information</b> . . . . .	<b>2</b>
<b>4</b>	<b>Marking</b> . . . . .	<b>3</b>
<b>5</b>	<b>Limiting values</b> . . . . .	<b>3</b>
<b>6</b>	<b>Thermal characteristics</b> . . . . .	<b>4</b>
<b>7</b>	<b>Characteristics</b> . . . . .	<b>6</b>
<b>8</b>	<b>Test information</b> . . . . .	<b>22</b>
8.1	Quality information . . . . .	22
<b>9</b>	<b>Package outline</b> . . . . .	<b>22</b>
<b>10</b>	<b>Soldering</b> . . . . .	<b>23</b>
<b>11</b>	<b>Revision history</b> . . . . .	<b>24</b>
<b>12</b>	<b>Legal information</b> . . . . .	<b>25</b>
12.1	Data sheet status . . . . .	25
12.2	Definitions . . . . .	25
12.3	Disclaimers . . . . .	25
12.4	Trademarks . . . . .	26
<b>13</b>	<b>Contact information</b> . . . . .	<b>26</b>
<b>14</b>	<b>Contents</b> . . . . .	<b>27</b>

## Looking for pricing, stock, or lifecycle information?

Click below to explore more details on WIN SOURCE:

-  [View PDTD114EUX on WIN SOURCE](#)
-  [Nexperia USA Inc. Information](#)

## Optimize Your Supply Chain with WIN SOURCE Solutions

-  Global Sourcing Solution
-  Obsolete Management
-  Cost Control Management
-  Shortage Management
-  Alternative Solution
-  Excess Inventory Management