



**THE DATASHEET OF  
IPW60R190E6FKSA1**



## 1 Description

CoolMOS™ is a revolutionary technology for high voltage power MOSFETs, designed according to the superjunction (SJ) principle and pioneered by Infineon Technologies. CoolMOS™ E6 series combines the experience of the leading SJ MOSFET supplier with high class innovation. The resulting devices provide all benefits of a fast switching SJ MOSFET while not sacrificing ease of use. Extremely low switching and conduction losses make switching applications even more efficient, more compact, lighter and cooler.

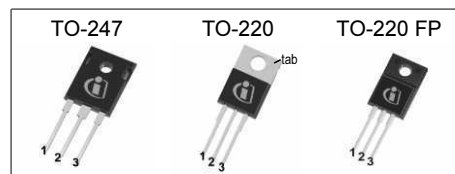

## Features

- Extremely low losses due to very low FOM  $R_{ds(on)} \cdot Q_g$  and  $E_{oss}$
- Very high commutation ruggedness
- Easy to use/drive
- Pb-free plating, Halogen free mold compound
- Qualified for industrial grade applications according to JEDEC (J-STD20 and JESD22)

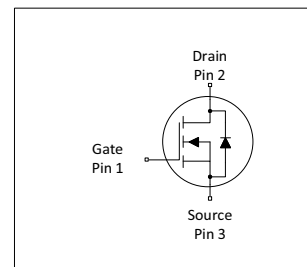

## Applications

PFC stages, hard switching PWM stages and resonant switching PWM stages for e.g. PC Silverbox, Adapter, LCD & PDP TV, Lighting, Server, Telecom and UPS.



**Table 1 Key Performance Parameters**

Parameter	Value	Unit
$V_{DS} @ T_{j,max}$	650	V
$R_{DS(on),max}$	0.19	$\Omega$
$Q_g,typ$	63	nC
$I_D,pulse$	59	A
$E_{oss} @ 400V$	5.2	$\mu J$
Body diode $di/dt$	500	A/ $\mu s$

Type / Ordering Code	Package	Marking	Related Links
IPW60R190E6	PG-TO 247	6R190E6	see Appendix A
IPP60R190E6	PG-TO 220		
IPA60R190E6	PG-TO 220 FullPAK		



**Table of Contents**

Description .....	2
Table of Contents .....	3
Maximum ratings .....	4
Thermal characteristics .....	5
Electrical characteristics .....	6
Electrical characteristics diagrams .....	8
Test Circuits .....	13
Package Outlines .....	14
Appendix A .....	17
Revision History .....	18
Disclaimer .....	18

## 2 Maximum ratings

at  $T_j = 25^\circ\text{C}$ , unless otherwise specified

**Table 2 Maximum ratings**

Parameter	Symbol	Values			Unit	Note / Test Condition
		Min.	Typ.	Max.		
Continuous drain current <sup>1)</sup>	$I_D$			20.2	A	$T_C = 25^\circ\text{C}$
				12.8		$T_C = 100^\circ\text{C}$
Pulsed drain current <sup>2)</sup>	$I_{D,pulse}$			59	A	$T_C = 25^\circ\text{C}$
Avalanche energy, single pulse	$E_{AS}$			418	mJ	$I_D = 3.4\text{A}$ , $V_{DD} = 50\text{V}$ (see table 11)
Avalanche energy, repetitive	$E_{AR}$			0.63	mJ	$I_D = 3.4\text{A}$ , $V_{DD} = 50\text{V}$
Avalanche current, repetitive	$I_{AR}$			3.4	A	
MOSFET dv/dt ruggedness	dv/dt			50	V/ns	$V_{DS} = 0 \dots 480\text{V}$
Gate source voltage	$V_{GS}$	-20		20	V	static
		-30		30		AC ( $f > 1\text{ Hz}$ )
Power dissipation (non FullPAK) TO-247, TO-220	$P_{tot}$			151.0	W	$T_C = 25^\circ\text{C}$
Power dissipation (FullPAK) TO-220 FP	$P_{tot}$			34.0	W	$T_C = 25^\circ\text{C}$
Operating and storage temperature	$T_j, T_{stg}$	-55		150	$^\circ\text{C}$	
Mounting torque (non FullPAK) TO-247, TO-220				60	Ncm	M3 and M3.5 screws
Mounting torque (FullPAK) TO-220 FP				50	Ncm	M2.5 screws
Continuous diode forward current	$I_S$			17.5	A	$T_C = 25^\circ\text{C}$
Diode pulse current	$I_{S,pulse}$			59	A	$T_C = 25^\circ\text{C}$
Reverse diode dv/dt <sup>3)</sup>	dv/dt			15	V/ns	$V_{DS} = 0 \dots 400\text{V}$ , $I_{SD} \leq I_D$ , $T_j = 25^\circ\text{C}$ (see table 9)
Maximum diode commutation speed	di/dt			500	A/ $\mu\text{s}$	
Insulation withstand voltage for TO-220FP	$V_{ISO}$	-	-	2500	V	$V_{rms}$ , $T_C = 25^\circ\text{C}$ , $t = 1\text{min}$

<sup>1)</sup> Limited by  $T_{j,max}$ . Maximum duty cycle  $D=0.75$

<sup>2)</sup> Pulse width  $t_p$  limited by  $T_{j,max}$

<sup>3)</sup> Identical low side and high side switch with identical  $R_G$

### 3 Thermal characteristics

**Table 3 Thermal characteristics TO-247, TO-220**

Parameter	Symbol	Values			Unit	Note / Test Condition
		Min.	Typ.	Max.		
Thermal resistance, junction - case	$R_{thJC}$			0.83	°C/W	
Thermal resistance, junction - ambient	$R_{thJA}$			62	°C/W	leaded
Soldering temperature, wavesoldering only allowed at leads	$T_{sold}$			260	°C	1.6 mm (0.063 in.) from case for 10s

**Table 4 Thermal characteristics TO-220 FP**

Parameter	Symbol	Values			Unit	Note / Test Condition
		Min.	Typ.	Max.		
Thermal resistance, junction - case	$R_{thJC}$			3.7	°C/W	
Thermal resistance, junction - ambient	$R_{thJA}$			80	°C/W	leaded
Soldering temperature, wavesoldering only allowed at leads	$T_{sold}$			260	°C	1.6 mm (0.063 in.) from case for 10s

## 4 Electrical characteristics

at  $T_j = 25^\circ\text{C}$ , unless otherwise specified

**Table 5 Static characteristics**

Parameter	Symbol	Values			Unit	Note / Test Condition
		Min.	Typ.	Max.		
Drain-source breakdown voltage	$V_{(BR)DSS}$	600			V	$V_{GS} = 0V, I_D = 0.25\text{mA}$
Gate threshold voltage	$V_{GS(th)}$	2.5	3	3.5	V	$V_{DS} = V_{GS}, I_D = 0.63\text{mA}$
Zero gate voltage drain current	$I_{DSS}$			1	$\mu\text{A}$	$V_{DS} = 600V, V_{GS} = 0V, T_j = 25^\circ\text{C}$
			10			$V_{DS} = 600V, V_{GS} = 0V, T_j = 150^\circ\text{C}$
Gate-source leakage current	$I_{GSS}$			100	nA	$V_{GS} = 20V, V_{DS} = 0V$
Drain-source on-state resistance	$R_{DS(on)}$		0.170	0.19	$\Omega$	$V_{GS} = 10V, I_D = 9.5A, T_j = 25^\circ\text{C}$
			0.440			$V_{GS} = 10V, I_D = 9.5A, T_j = 150^\circ\text{C}$
Gate resistance	$R_G$		6		$\Omega$	$f = 1\text{MHz}$ , open drain

**Table 6 Dynamic characteristics**

Parameter	Symbol	Values			Unit	Note / Test Condition
		Min.	Typ.	Max.		
Input capacitance	$C_{iss}$		1400		pF	$V_{GS} = 0V, V_{DS} = 100V, f = 1\text{MHz}$
Output capacitance	$C_{oss}$		85		pF	
Effective output capacitance, energy related <sup>1)</sup>	$C_{o(er)}$		56		pF	$V_{GS} = 0V, V_{DS} = 0 \dots 480V$
Effective output capacitance, time related <sup>2)</sup>	$C_{o(tr)}$		266		pF	$I_D = \text{constant}, V_{GS} = 0V, V_{DS} = 0 \dots 480V$
Turn-on delay time	$t_{d(on)}$		12		ns	$V_{DD} = 400V, V_{GS} = 13V, I_D = 9.5A, R_G = 3.4\Omega$ (see table 10)
Rise time	$t_r$		10		ns	
Turn-off delay time	$t_{d(off)}$		90		ns	
Fall time	$t_f$		8		ns	

**Table 7 Gate charge characteristics**

Parameter	Symbol	Values			Unit	Note / Test Condition
		Min.	Typ.	Max.		
Gate to source charge	$Q_{gs}$		7.6		nC	$V_{DD} = 480V, I_D = 9.5A, V_{GS} = 0 \text{ to } 10V$
Gate to drain charge	$Q_{gd}$		32		nC	
Gate charge total	$Q_g$		63		nC	
Gate plateau voltage	$V_{plateau}$		5.4		V	

<sup>1)</sup>  $C_{o(er)}$  is a fixed capacitance that gives the same stored energy as  $C_{oss}$  while  $V_{DS}$  is rising from 0 to 80%  $V_{(BR)DSS}$

<sup>2)</sup>  $C_{o(tr)}$  is a fixed capacitance that gives the same charging time as  $C_{oss}$  while  $V_{DS}$  is rising from 0 to 80%  $V_{(BR)DSS}$

**Table 8 Reverse diode characteristics**

Parameter	Symbol	Values			Unit	Note / Test Condition
		Min.	Typ.	Max.		
Diode forward voltage	$V_{SD}$		0.9		V	$V_{GS} = 0V, I_F = 9.5A, T_j = 25^\circ C$
Reverse recovery time	$t_{rr}$		430		ns	$V_R = 400V, I_F = 9.5A,$ $di_F/dt = 100A/\mu s$ (see table 9)
Reverse recovery charge	$Q_{rr}$		6.9		$\mu C$	
Peak reverse recovery current	$I_{rrm}$		30		A	

## 5 Electrical characteristics diagrams

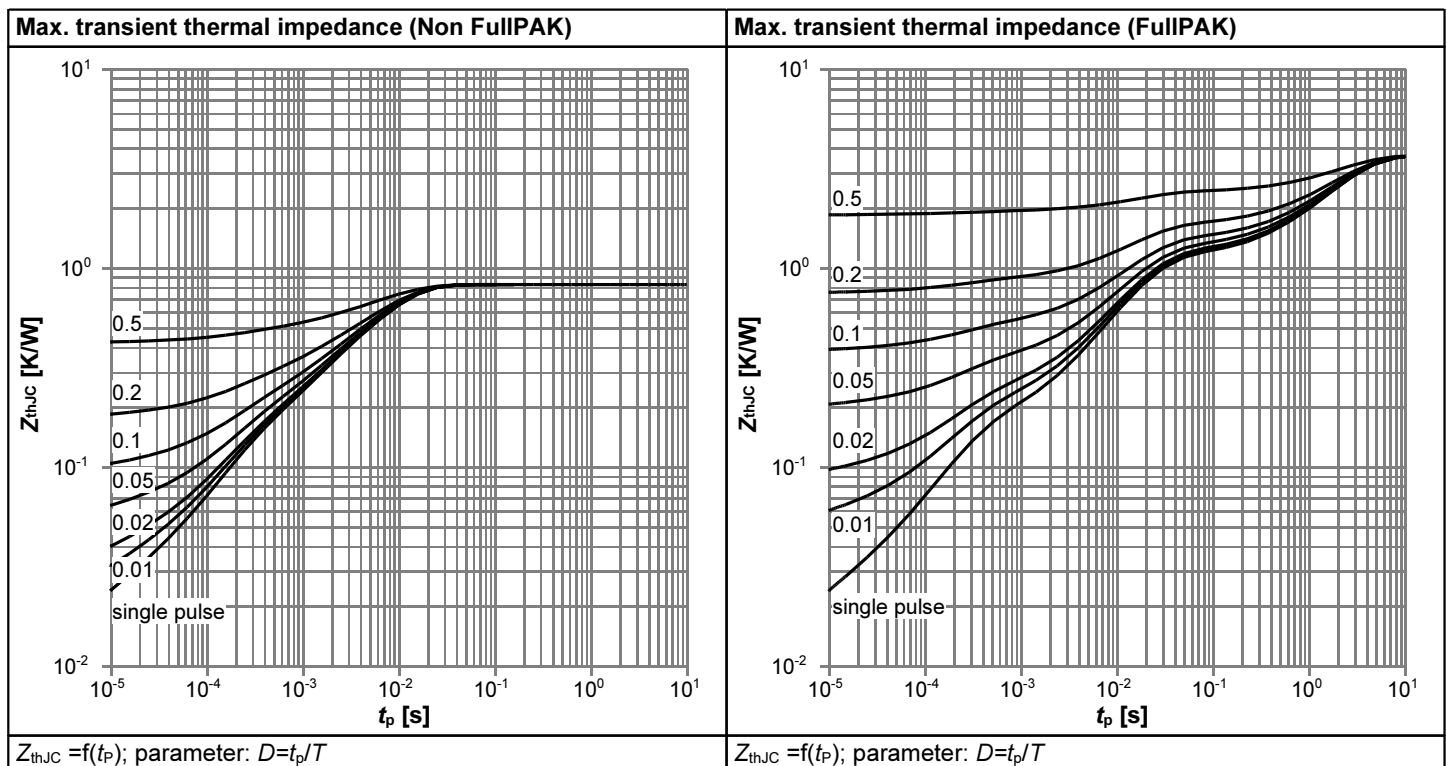
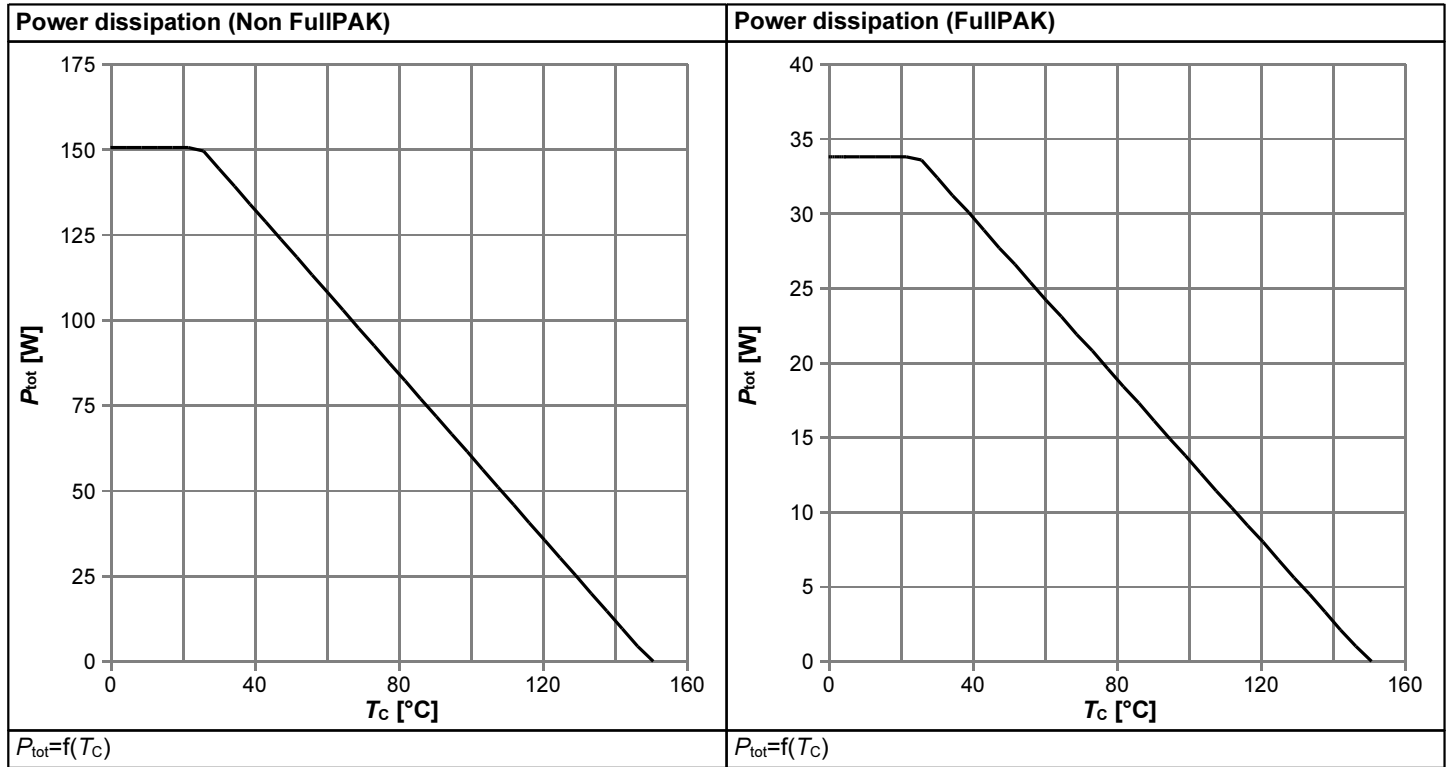

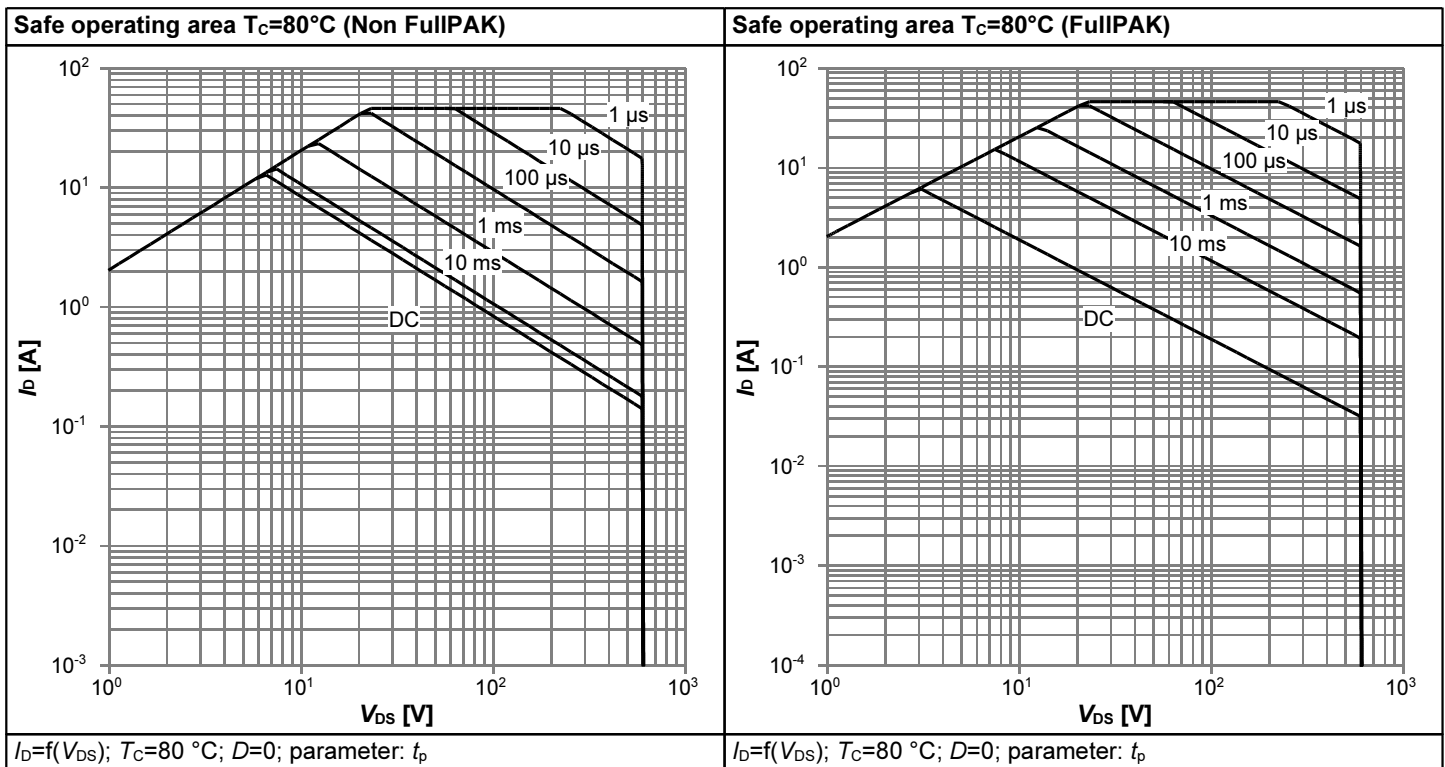
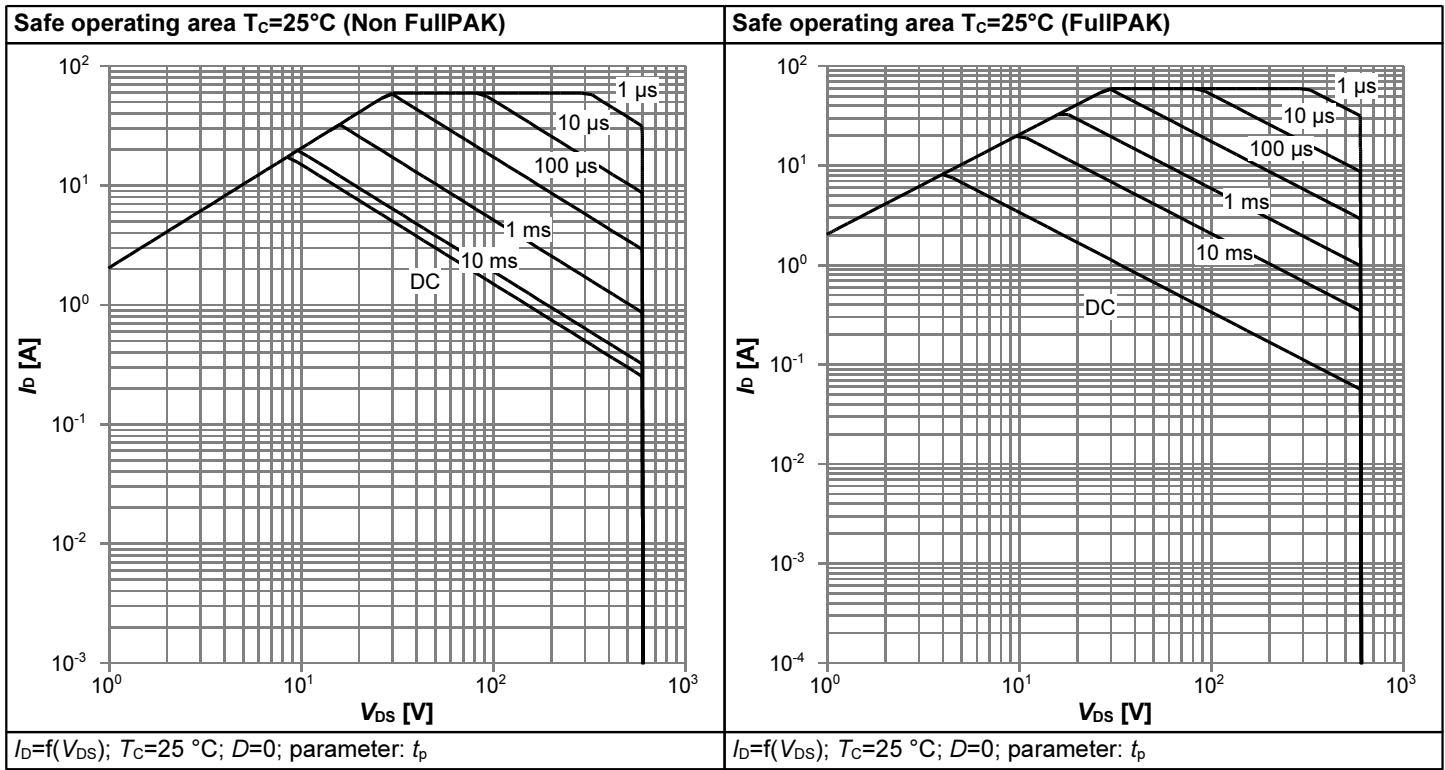

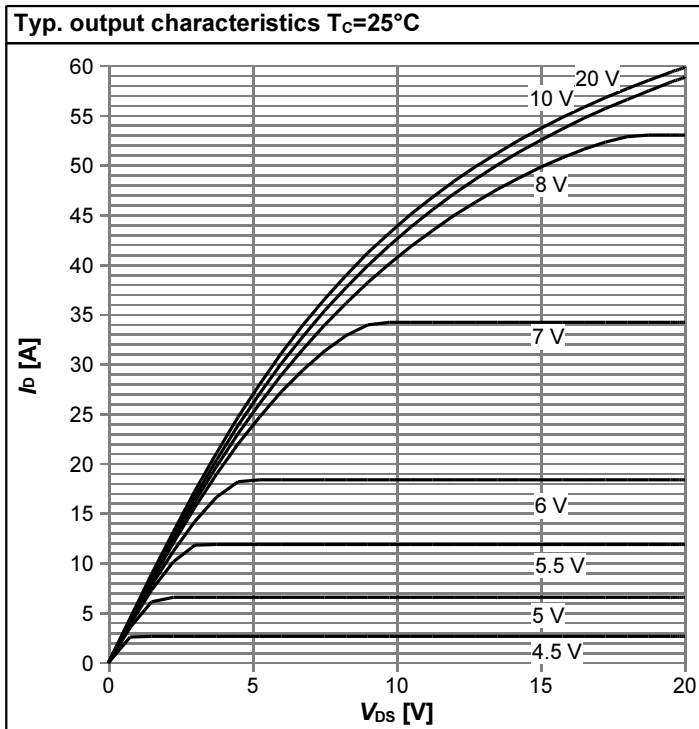

$I_D=f(V_{DS}); T_j=25^\circ\text{C};$  parameter:  $V_{GS}$

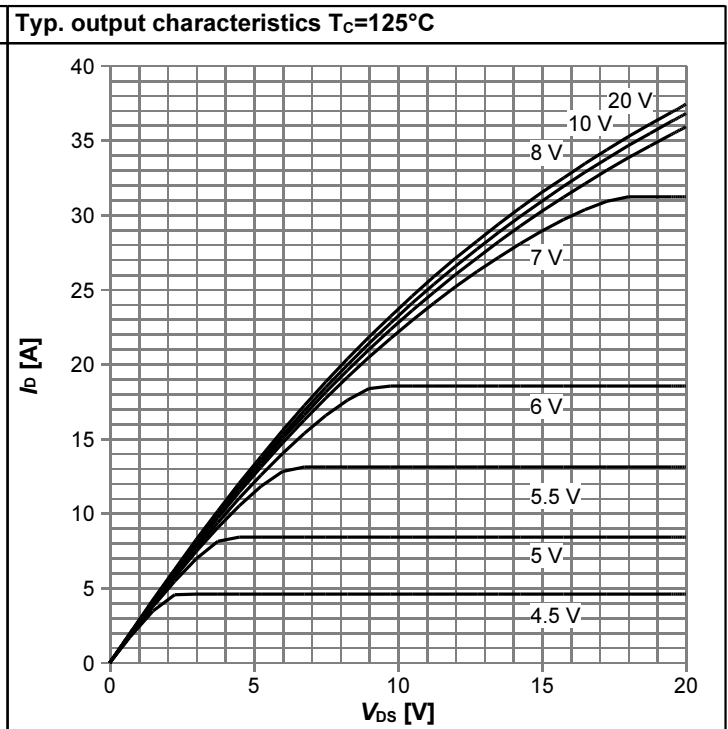

$I_D=f(V_{DS}); T_j=125^\circ\text{C};$  parameter:  $V_{GS}$

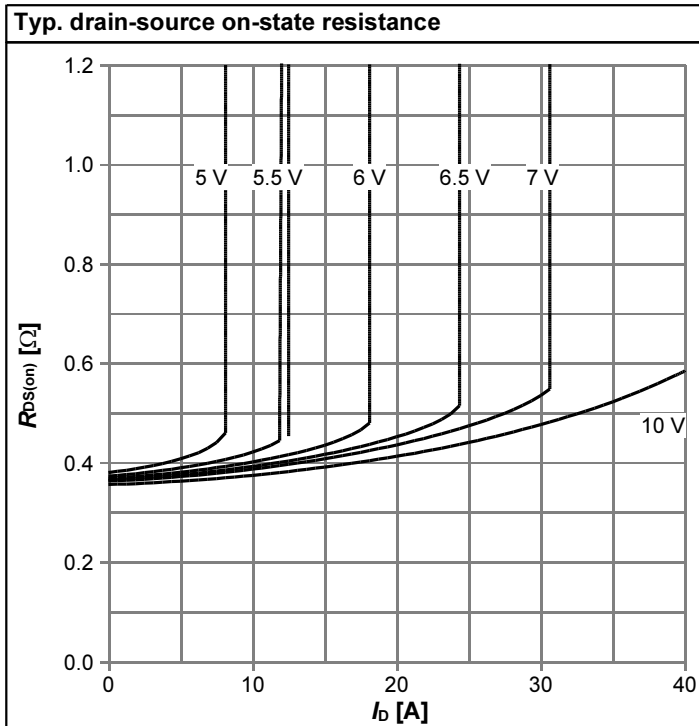

$R_{DS(on)}=f(I_D); T_j=125^\circ\text{C};$  parameter:  $V_{GS}$

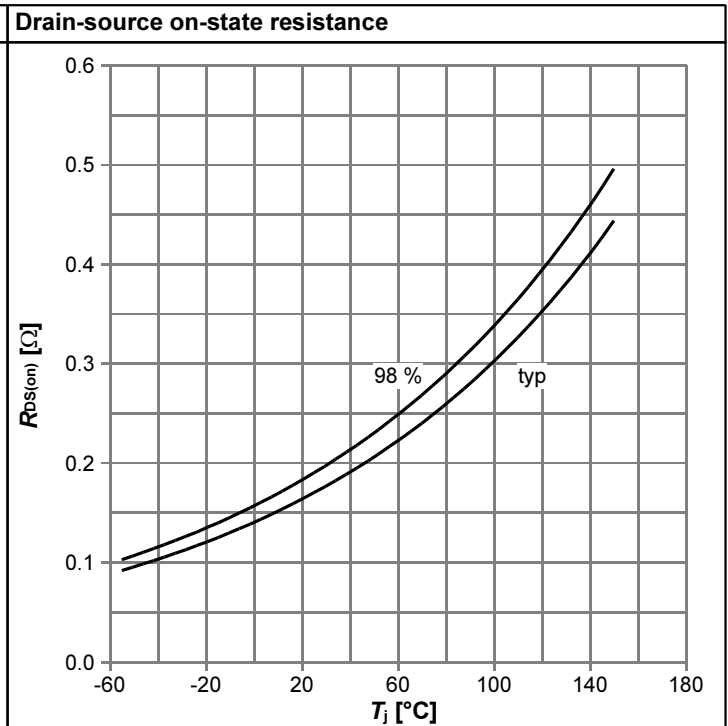

$R_{DS(on)}=f(T_j); I_D=9.5\text{ A}; V_{GS}=10\text{ V}$

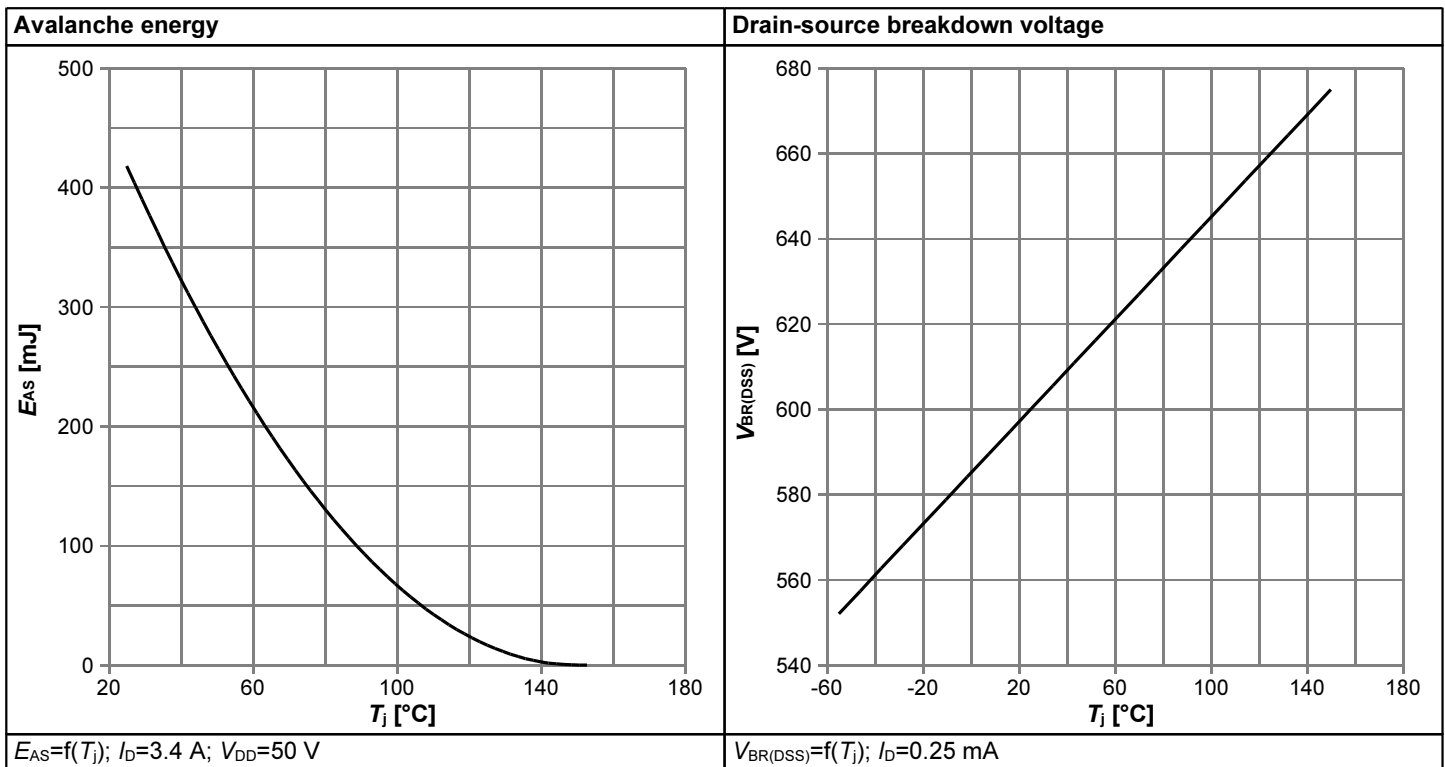
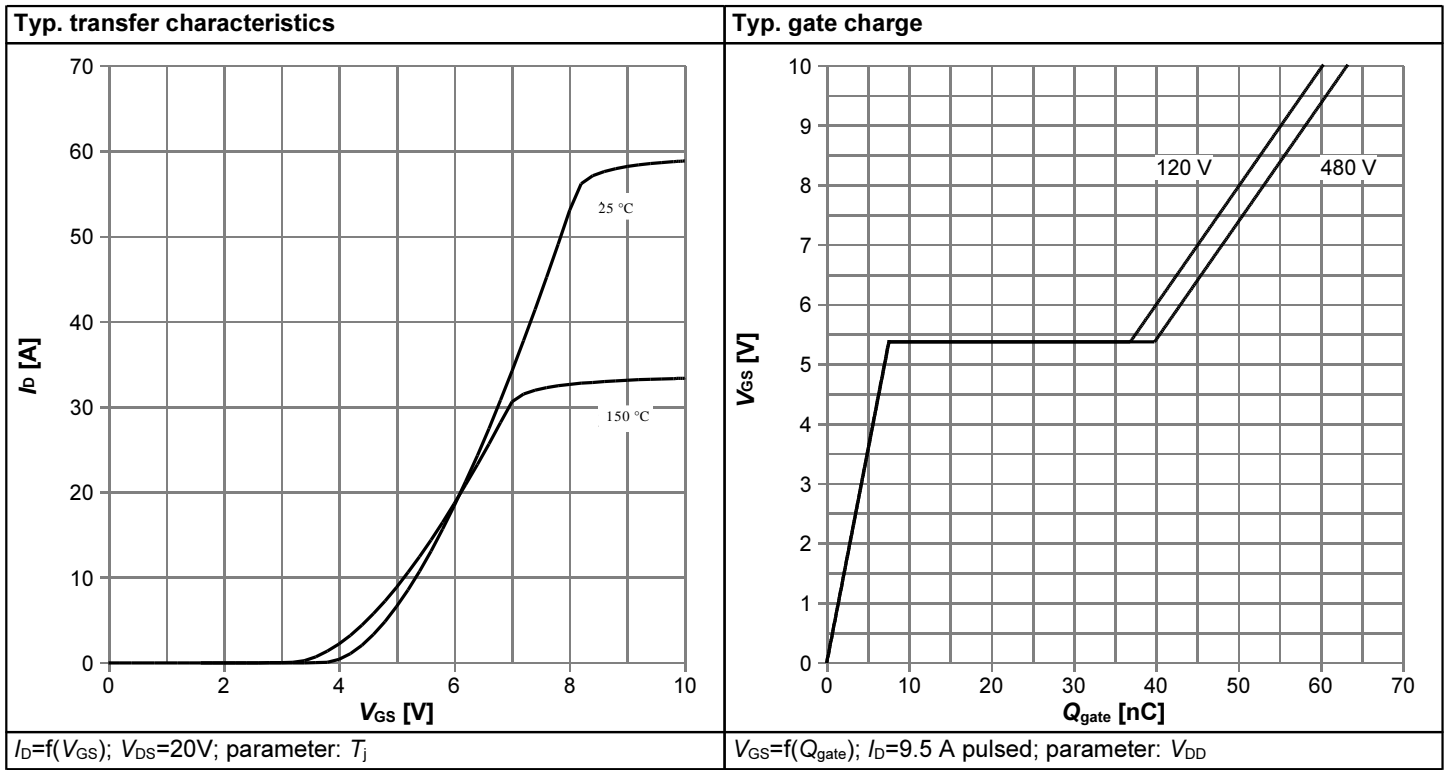

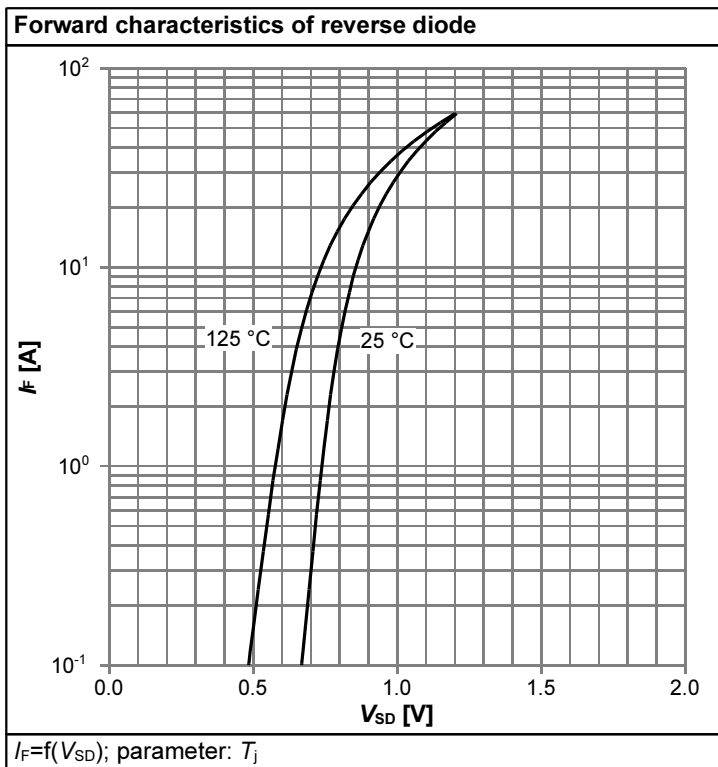
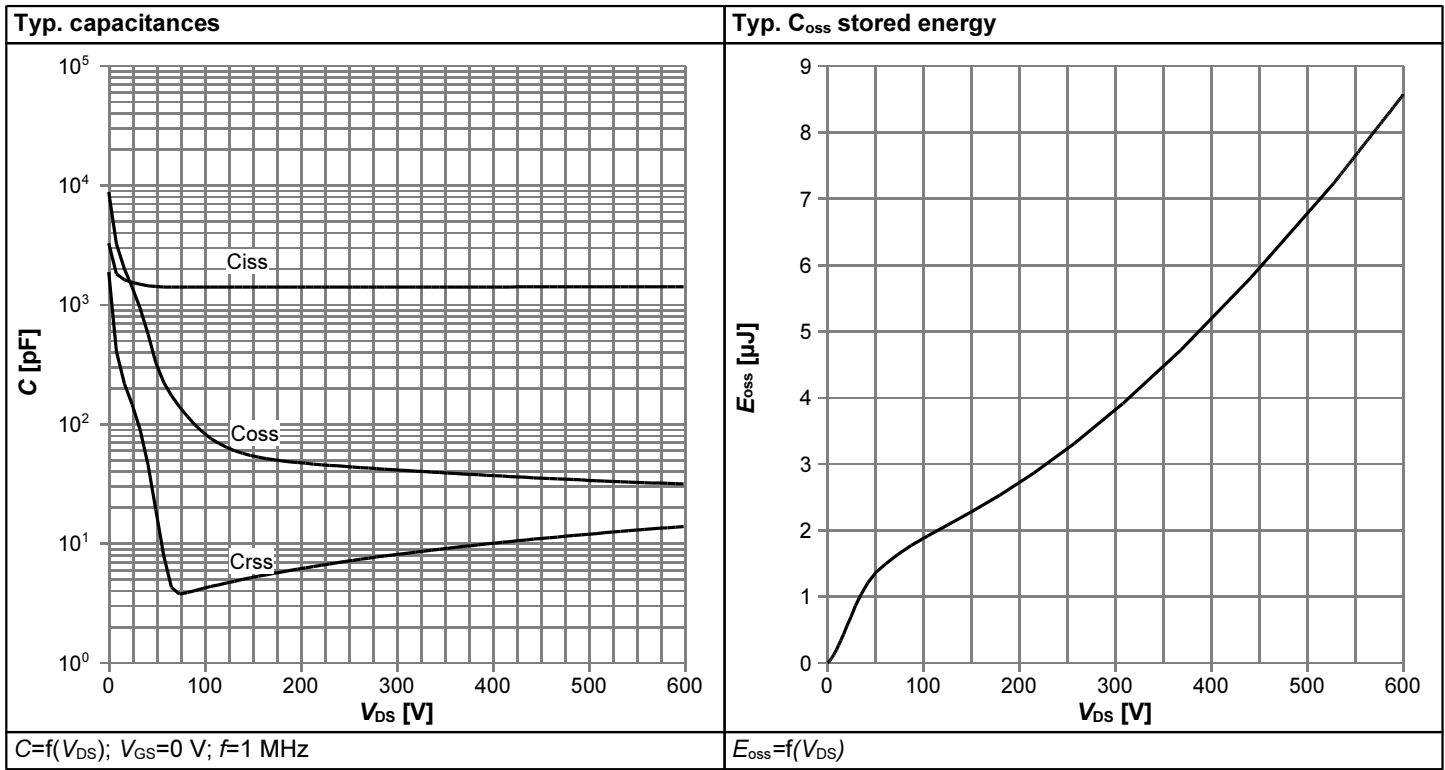

## 6 Test Circuits

**Table 9 Diode characteristics**

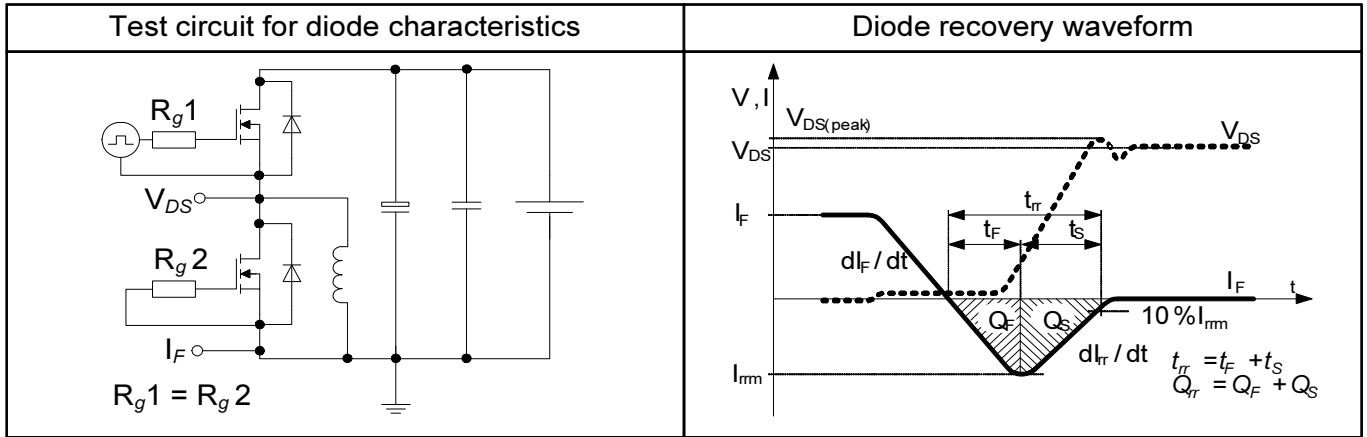

**Table 10 Switching times**

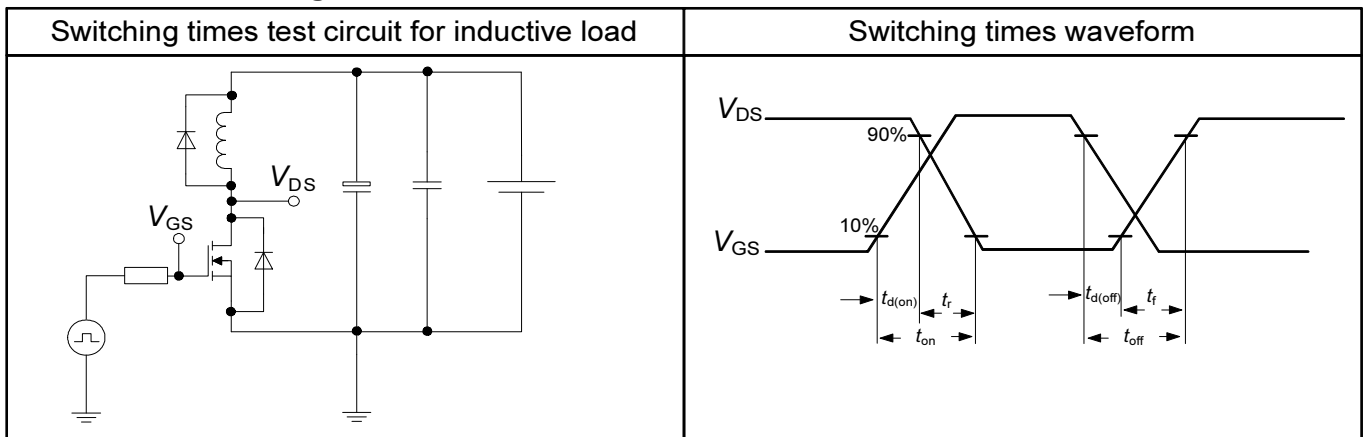

**Table 11 Unclamped inductive load**

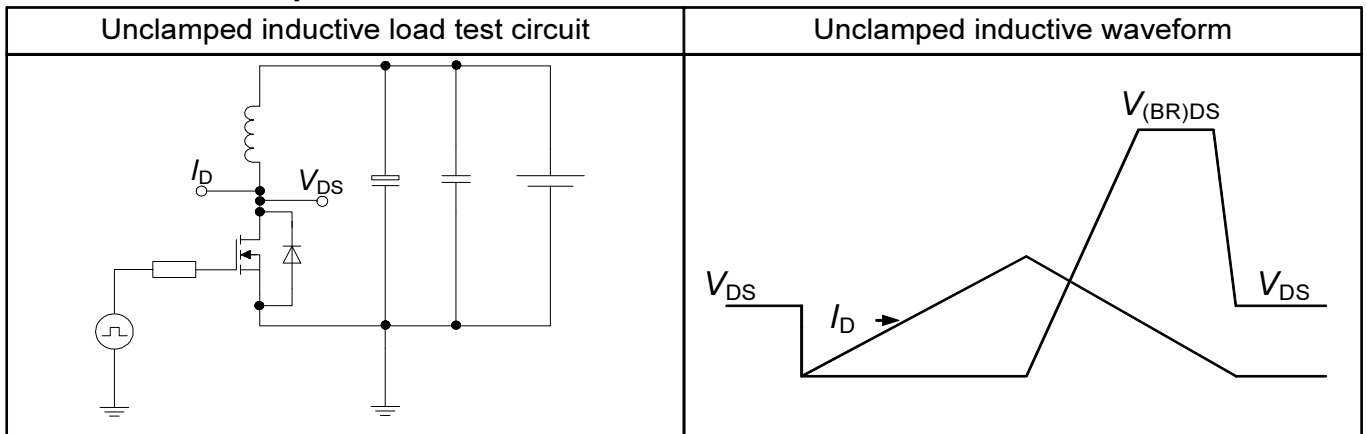

## 7 Package Outlines

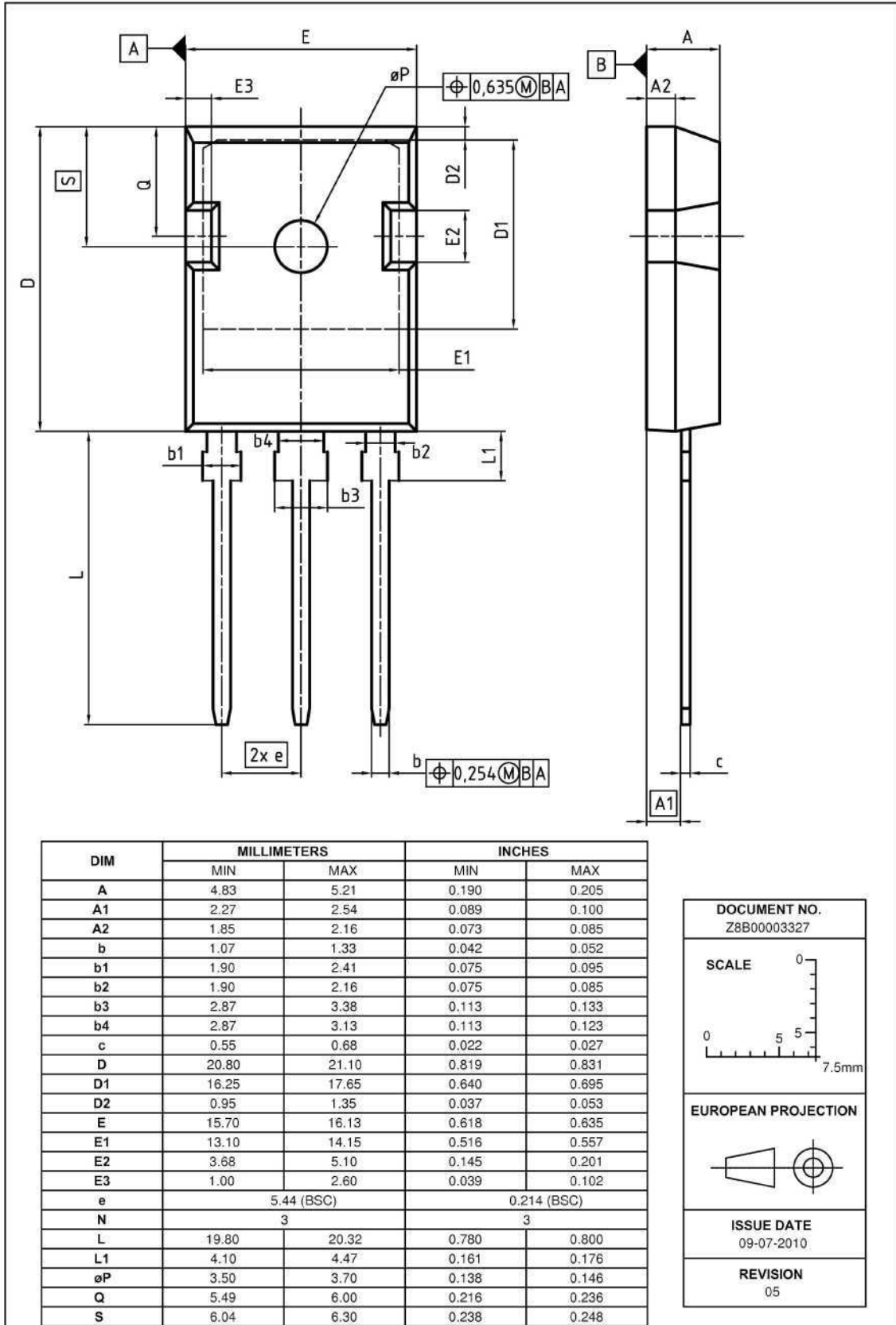

Figure 1 Outline PG-TO 247, dimensions in mm/inches

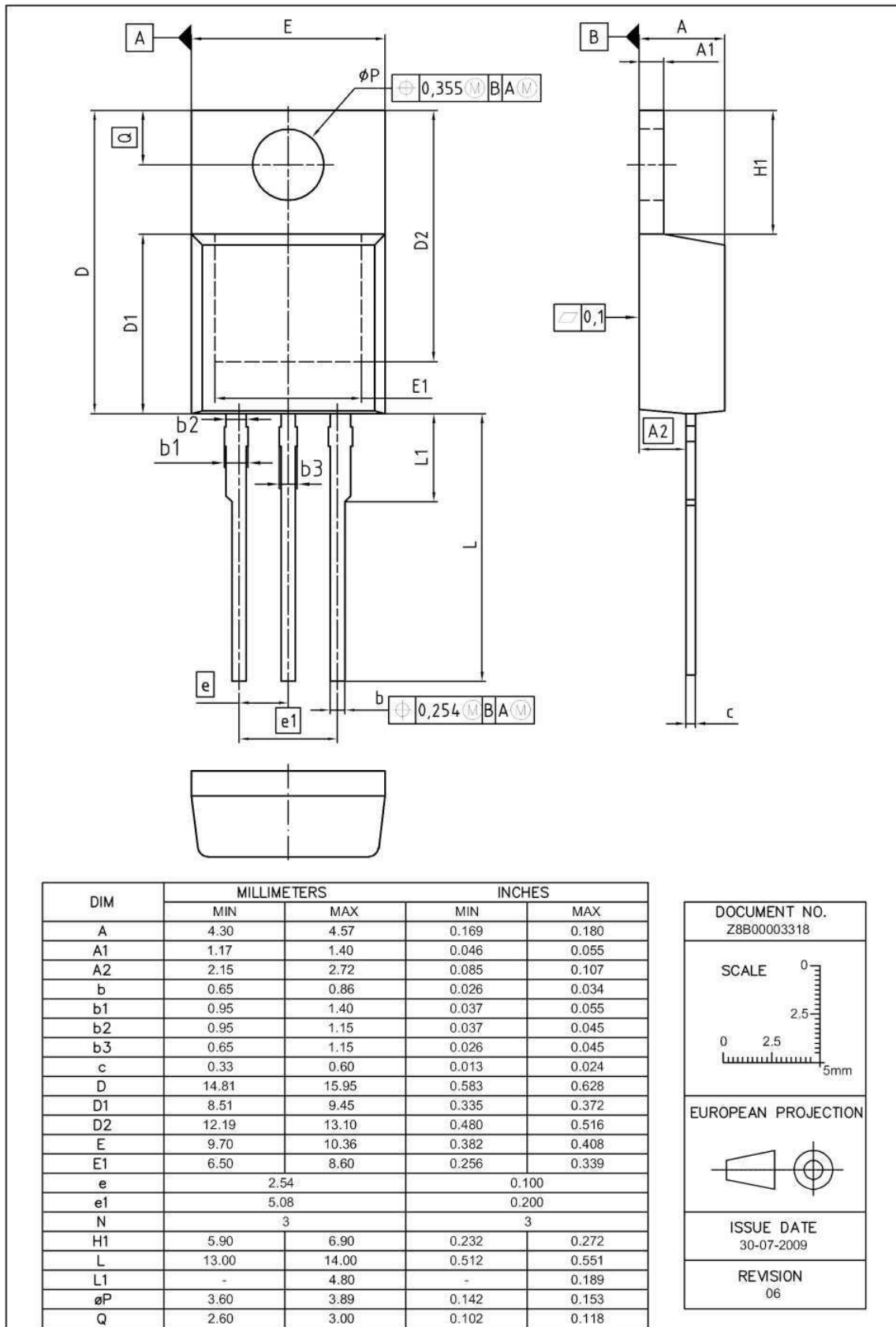

Figure 2 Outline PG-TO 220, dimensions in mm/inches



## 8 Appendix A

### Table 12 Related Links

- IFX CoolMOS Webpage: [www.infineon.com](http://www.infineon.com)
- IFX Design Tools: [www.infineon.com](http://www.infineon.com)

## Revision History

IPX60R190E6

**Revision: 2017-10-17, Rev. 2.4**

Previous Revision

Revision	Date	Subjects (major changes since last revision)
2.4	2017-10-17	Rev. 2.1 to Rev. 2.3: Package drawing modifications. Rev. 2.4: Added Full PAK insulation voltage rating in Table 2 on page 3. Revised transfer characteristics graph on Page 10

### Trademarks of Infineon Technologies AG

AURIX™, C166™, CanPAK™, CIPOS™, CoolGaN™, CoolMOS™, CoolSET™, CoolSiC™, CORECONTROL™, CROSSAVE™, DAVE™, DI-POL™, DrBlade™, EasyPIM™, EconoBRIDGE™, EconoDUAL™, EconoPACK™, EconoPIM™, EiceDRIVER™, eupec™, FCOS™, HITFET™, HybridPACK™, Infineon™, ISOFACE™, IsoPACK™, i-Wafer™, MIPAQ™, ModSTACK™, my-d™, NovalithiC™, OmniTune™, OPTIGA™, OptiMOS™, ORIGA™, POWERCODE™, PRIMARION™, PrimePACK™, PrimeSTACK™, PROFET™, PRO-SiL™, RASIC™, REAL3™, ReverSave™, SatRIC™, SIEGET™, SiPMOS™, SmartLEWIS™, SOLID FLASH™, SPOC™, TEMPFET™, thinQ!™, TRENCHSTOP™, TriCore™.

Trademarks updated August 2015

### Other Trademarks

All referenced product or service names and trademarks are the property of their respective owners.

### We Listen to Your Comments

Any information within this document that you feel is wrong, unclear or missing at all? Your feedback will help us to continuously improve the quality of this document. Please send your proposal (including a reference to this document) to:

[erratum@infineon.com](mailto:erratum@infineon.com)

**Published by**  
**Infineon Technologies AG**  
**81726 München, Germany**  
**© 2017 Infineon Technologies AG**  
**All Rights Reserved.**

### Legal Disclaimer

The information given in this document shall in no event be regarded as a guarantee of conditions or characteristics ("Beschaffenheitsgarantie").

With respect to any examples, hints or any typical values stated herein and/or any information regarding the application of the product, Infineon Technologies hereby disclaims any and all warranties and liabilities of any kind, including without limitation warranties of non-infringement of intellectual property rights of any third party.

In addition, any information given in this document is subject to customer's compliance with its obligations stated in this document and any applicable legal requirements, norms and standards concerning customer's products and any use of the product of Infineon Technologies in customer's applications.

The data contained in this document is exclusively intended for technically trained staff. It is the responsibility of customer's technical departments to evaluate the suitability of the product for the intended application and the completeness of the product information given in this document with respect to such application.

### Information

For further information on technology, delivery terms and conditions and prices please contact your nearest Infineon Technologies Office ([www.infineon.com](http://www.infineon.com)).



### Warnings

Due to technical requirements, components may contain dangerous substances. For information on the types in question, please contact the nearest Infineon Technologies Office.

The Infineon Technologies component described in this Data Sheet may be used in life-support devices or systems and/or automotive, aviation and aerospace applications or systems only with the express written approval of Infineon Technologies, if a failure of such components can reasonably be expected to cause the failure of that life-support, automotive, aviation and aerospace device or system or to affect the safety or effectiveness of that device or system. Life support devices or systems are intended to be implanted in the human body or to support and/or maintain and sustain and/or protect human life. If they fail, it is reasonable to assume that the health of the user or other persons may be endangered.

## Looking for pricing, stock, or lifecycle information?

Click below to explore more details on WIN SOURCE:

-  [View IPW60R190E6FKSA1 on WIN SOURCE](#)
-  [Infineon Technologies Information](#)

## Optimize Your Supply Chain with WIN SOURCE Solutions

-  Global Sourcing Solution
-  Obsolete Management
-  Cost Control Management
-  Shortage Management
-  Alternative Solution
-  Excess Inventory Management