



**THE DATASHEET OF
DCX114EH-7**



**COMPLEMENTARY NPN/PNP PRE-BIASED
SMALL SIGNAL TRANSISTORS in SOT563**
Features

- Epitaxial Planar Die Construction
- Built-In Biasing Resistors
- **Totally Lead-Free & Fully RoHS Compliant (Notes 1 & 2)**
- **Halogen and Antimony Free. "Green" Device (Note 3)**

Part Number	R1	R2	Marking
DCX124EH	22kΩ	22kΩ	C17
DCX144EH	47kΩ	47kΩ	C20
DCX143EH	4.7kΩ	4.7kΩ	C08
DCX114YH	10kΩ	47kΩ	C14
DCX123JH	2.2kΩ	47kΩ	C06
DCX114EH	10kΩ	10kΩ	C13
DCX143TH	4.7kΩ	—	C07
DCX114TH	10kΩ	—	C12

Mechanical Data

- Case: SOT563
- Case Material: Molded Plastic "Green" Molding Compound; UL Flammability Classification Rating 94V-0
- Moisture Sensitivity: Level 1 per J-STD-020
- Terminals: Finish - Matte Tin Annealed over Copper Leadframe. Solderable per MIL-STD-202, Method 208 (E3)
- Terminal Connections: See Diagram
- Weight: 0.005 grams (Approximate)

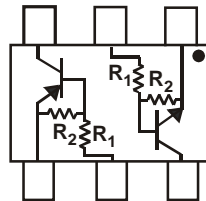

R₁, R₂ Device Schematic
Top View

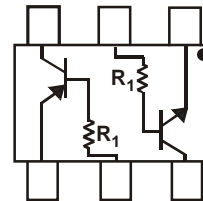

R₁ Only Device Schematic
Top View

Ordering Information (Note 4)

Part Number	Packaging	Shipping
DCX124EH-7	SOT563	3,000/Tape & Reel
DCX144EH-7	SOT563	3,000/Tape & Reel
DCX143EH-7	SOT563	3,000/Tape & Reel
DCX114YH-7	SOT563	3,000/Tape & Reel
DCX123JH-7	SOT563	3,000/Tape & Reel
DCX114EH-7	SOT563	3,000/Tape & Reel
DCX143TH-7	SOT563	3,000/Tape & Reel
DCX114TH-7	SOT563	3,000/Tape & Reel

- Notes:
1. No purposely added lead. Fully EU Directive 2002/95/EC (RoHS), 2011/65/EU (RoHS 2) & 2015/863/EU (RoHS 3) compliant.
 2. See <https://www.diodes.com/quality/lead-free/> for more information about Diodes Incorporated's definitions of Halogen- and Antimony-free, "Green" and Lead-free.
 3. Halogen- and Antimony-free "Green" products are defined as those which contain <900ppm bromine, <900ppm chlorine (<1500ppm total Br + Cl) and <1000ppm antimony compounds.
 4. For packaging details, go to our website at <https://www.diodes.com/design/support/packaging/diodes-packaging/>.

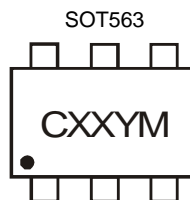
Marking Information

CXX = Product Type Marking Code
 YM = Date Code Marking
 Y = Year ex: F = 2018
 M = Month ex: 9 = September

Date Code Key

Year	2018	2019	2020	2021	2022	2023	2024
Code	F	G	H	I	J	K	L

Month	Jan	Feb	Mar	Apr	May	Jun	Jul	Aug	Sep	Oct	Nov	Dec
Code	1	2	3	4	5	6	7	8	9	O	N	D

Maximum Ratings NPN Section (@ $T_A = +25^\circ\text{C}$, unless otherwise specified.)

Characteristic		Symbol	Value	Unit
Supply Voltage		V_{CC}	50	V
Input Voltage	DCX124EH DCX144EH DCX143EH DCX114YH DCX123JH DCX114EH DCX143TH DCX114TH	V_{IN}	-10 to +40 -10 to +40 -10 to +30 -6 to +40 -5 to +12 -10 to +40 -5V Max -5V Max	V
Output Current	DCX124EH DCX144EH DCX143EH DCX114YH DCX123JH DCX114EH DCX143TH DCX114TH	I_O	30 30 100 70 100 50 100 100	mA
Output Current	All	I_C (Max)	100	mA
Power Dissipation	(Total)	P_D	150	mW
Thermal Resistance, Junction to Ambient Air	(Note 5)	$R_{\theta JA}$	833	$^\circ\text{C/W}$
Operating and Storage Temperature Range		T_J, T_{STG}	-55 to +150	$^\circ\text{C}$

Note: 5. Mounted on FR-4 Board with recommended pad layout at <http://www.diodes.com/package-outlines.html>.

Maximum Ratings PNP Section (@ $T_A = +25^\circ\text{C}$, unless otherwise specified.)

Characteristic		Symbol	Value	Unit
Supply Voltage		V_{CC}	-50	V
Input Voltage	DCX124EH DCX144EH DCX143EH DCX114YH DCX123JH DCX114EH DCX143TH DCX114TH	V_{IN}	+10 to -40 +10 to -40 +10 to -30 +6 to -40 +5 to -12 +10 to -40 +5V max +5V max	V
Output Current	DCX124EH DCX144EH DCX143EH DCX114YH DCX123JH DCX114EH DCX143TH DCX114TH	I_O	-30 -30 -100 -70 -100 -50 -100 -100	mA
Output Current	All	I_C (Max)	-100	mA
Power Dissipation	(Total)	P_D	150	mW
Operating and Storage Temperature Range		T_J, T_{STG}	-55 to +150	$^\circ\text{C}$

Electrical Characteristics NPN Section (@T_A = +25°C, unless otherwise specified.)

Characteristic (DCX143TH & DCX114TH Only)	Symbol	Min	Typ	Max	Unit	Test Condition
Collector-Base Breakdown Voltage	BV _{CBO}	50	—	—	V	I _C = 50μA
Collector-Emitter Breakdown Voltage	BV _{CEO}	50	—	—	V	I _C = 1mA
Emitter-Base Breakdown Voltage	BV _{EBO}	5	—	—	V	I _E = 50μA
Collector Cut-Off Current	I _{CBO}	—	—	0.5	μA	V _{CB} = 50V
Emitter Cut-Off Current	I _{EBO}	—	—	0.5	μA	V _{EB} = 4V
Collector-Emitter Saturation Voltage	V _{CE(SAT)}	—	—	0.3	V	I _C /I _B = 2.5mA / 0.25mA DCX143TH I _C /I _B = 1mA / 0.1mA DCX114TH
DC Current Transfer Ratio	h _{FE}	100	250	600	—	I _C = 1mA, V _{CE} = 5V
Gain-Bandwidth Product (Note 6)	f _T	—	250	—	MHz	V _{CE} = 10V, I _E = 5mA, f = 100MHz

Characteristic	Symbol	Min	Typ	Max	Unit	Test Condition
Input Voltage	DCX124EH	0.5	1.1	—	V	V _{CC} = 5V, I _O = 100μA
	DCX144EH	0.5	1.1	—		
	DCX143EH	0.5	1.1	—		
	DCX114YH	0.3	—	—		
	DCX123JH	0.5	—	—		
	DCX114EH	0.5	1.1	—		
Input Voltage	DCX124EH	—	1.9	3.0	V	V _O = 0.3V, I _O = 5mA
	DCX144EH	—	1.9	3.0		
	DCX143EH	—	1.9	3.0		
	DCX114YH	—	—	1.4		
	DCX123JH	—	—	1.1		
	DCX114EH	—	1.9	3.0		
Output Voltage	DCX124EH	—	0.1	0.3	V	I _O /I _I = 10mA / 0.5mA
	DCX144EH	—	0.1	0.3		
	DCX143EH	—	0.1	0.3		
	DCX114YH	—	0.1	0.3		
	DCX123JH	—	0.1	0.3		
	DCX114EH	—	0.1	0.3		
Input Current	DCX124EH	—	—	0.36	mA	V _I = 5V
	DCX144EH	—	—	0.18		
	DCX143EH	—	—	1.8		
	DCX114YH	—	—	0.88		
	DCX123JH	—	—	3.6		
	DCX114EH	—	—	0.88		
Output Current	I _{O(OFF)}	—	—	0.5	μA	V _{CC} = 50V, V _I = 0V
DC Current Gain	DCX124EH	56	—	—	—	V _O = 5V, I _O = 5mA
	DCX144EH	68	—	—		
	DCX143EH	20	—	—		
	DCX114YH	68	—	—		
	DCX123JH	80	—	—		
	DCX114EH	30	—	—		

Note: 6. Transistor - For Reference Only.

Electrical Characteristics PNP Section (@T_A = +25°C, unless otherwise specified.)

Characteristic (DCX143TH & DCX114TH Only)	Symbol	Min	Typ	Max	Unit	Test Condition
Collector-Base Breakdown Voltage	BV _{CBO}	-50	—	—	V	I _C = -50μA
Collector-Emitter Breakdown Voltage	BV _{CEO}	-50	—	—	V	I _C = -1mA
Emitter-Base Breakdown Voltage	BV _{EBO}	-5	—	—	V	I _E = -50μA
Collector Cut-Off Current	I _{CBO}	—	—	-0.5	μA	V _{CB} = -50V
Emitter Cut-Off Current	I _{EBO}	—	—	-0.5	μA	V _{EB} = -4V
Collector-Emitter Saturation Voltage	V _{CE(SAT)}	—	—	-0.3	V	I _C /I _B = -2.5mA / -0.25mA DCX143TH I _C /I _B = -1mA / -0.1mA DCX114TH
DC Current Transfer Ratio	h _{FE}	100	250	600	—	I _C = -1mA, V _{CE} = -5V
Gain-Bandwidth Product (Note 6)	f _T	—	250	—	MHz	V _{CE} = -10V, I _E = -5mA, f = 100MHz

Characteristic	Symbol	Min	Typ	Max	Unit	Test Condition
Input Voltage	V _{I(OFF)}	-0.5	-1.1	—	V	V _{CC} = -5V, I _O = -100μA
		-0.5	-1.1	—		
-0.5		-1.1	—			
-0.3		—	—			
-0.5		—	—			
-0.5		-1.1	—			
Input Voltage	V _{I(ON)}	—	-1.9	-3.0	V	V _O = -0.3V, I _O = -5mA V _O = -0.3V, I _O = -2mA V _O = -0.3V, I _O = -20mA V _O = -0.3V, I _O = -1mA V _O = -0.3V, I _O = -5mA V _O = -0.3V, I _O = -10mA
		—	-1.9	-3.0		
		—	-1.9	-3.0		
		—	-1.4	-3.0		
		—	-1.1	-3.0		
		—	-1.9	-3.0		
Output Voltage	V _{O(ON)}	—	-0.1	-0.3	V	I _O /I _I = -10mA / -0.5mA I _O /I _I = -10mA / -0.5mA I _O /I _I = -10mA / -0.5mA I _O /I _I = -5mA / -0.25mA I _O /I _I = -5mA / -0.25mA I _O /I _I = -10mA / -0.5mA
		—	-0.1	-0.3		
		—	-0.1	-0.3		
		—	-0.1	-0.3		
		—	-0.1	-0.3		
		—	-0.1	-0.3		
Input Current	I _I	—	—	-0.36	mA	V _I = -5V
		—	—	-0.18		
		—	—	-1.8		
		—	—	-0.88		
		—	—	-3.6		
		—	—	-0.88		
Output Current	I _{O(OFF)}	—	—	-0.5	μA	V _{CC} = -50V, V _I = 0V
DC Current Gain	G _I	56	—	—	—	V _O = -5V, I _O = -5mA V _O = -5V, I _O = -5mA V _O = -5V, I _O = -10mA V _O = -5V, I _O = -10mA V _O = -5V, I _O = -10mA V _O = -5V, I _O = -5mA
		68	—	—		
		20	—	—		
		68	—	—		
		80	—	—		
		30	—	—		
Gain-Bandwidth Product (Note 6)	f _T	—	250	—	MHz	V _{CE} = -10V, I _E = -5mA, f = 100MHz

Note: 6. Transistor - For Reference Only.

Typical Curves – DCX143EH NPN Section

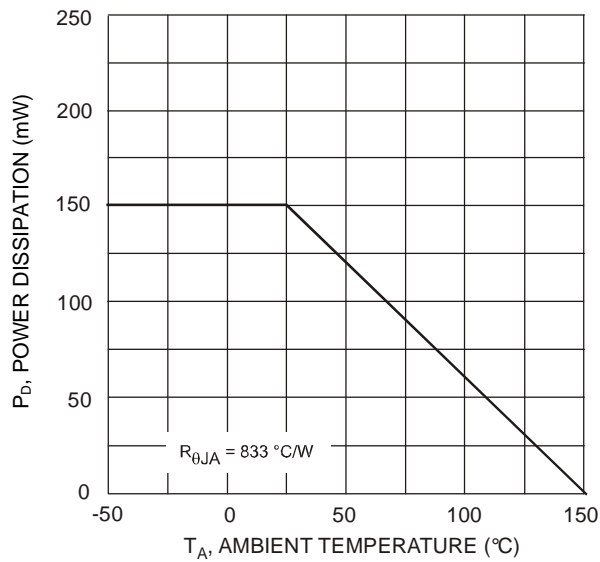

Fig. 1 Derating Curve - Total

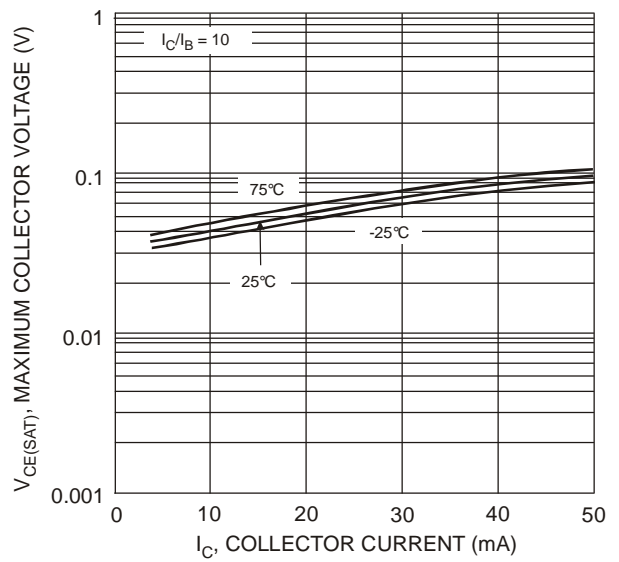

Fig. 2 $V_{CE(SAT)}$ vs. I_C

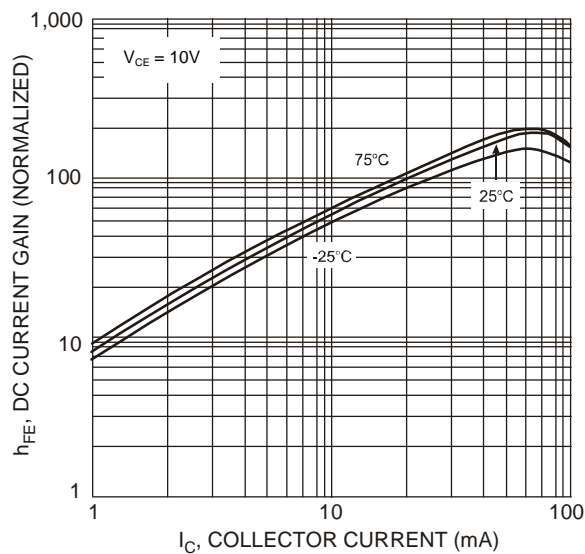

Fig. 3 DC Current Gain

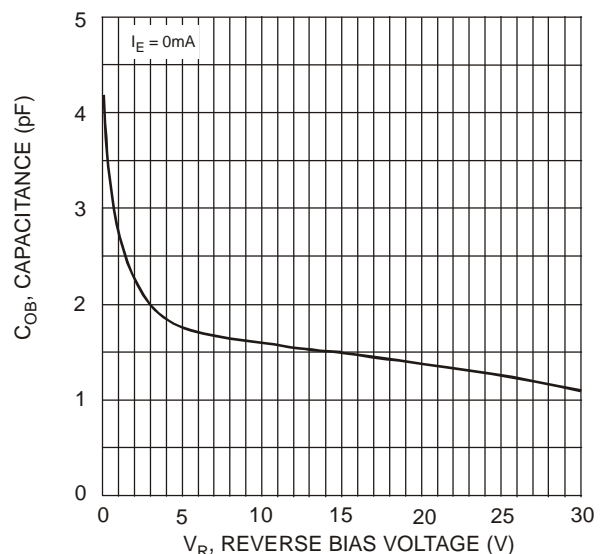

Fig. 4 Output Capacitance

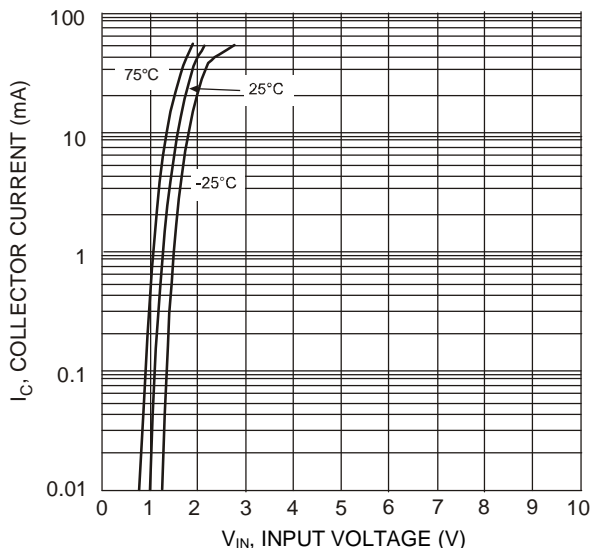

Fig. 5 Collector Current vs. Input Voltage

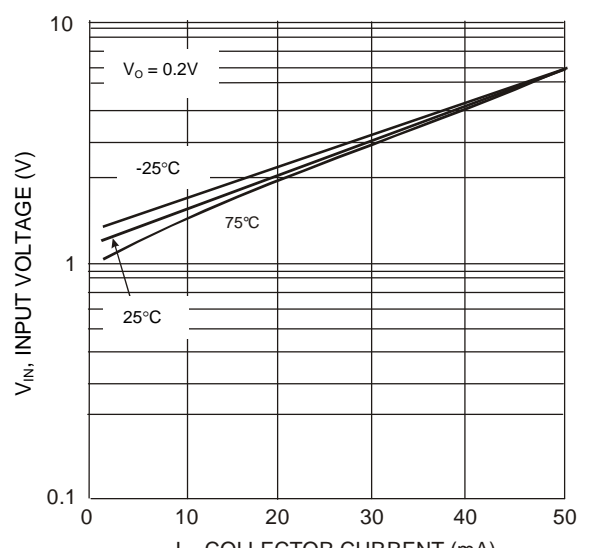

Fig. 6 Input Voltage vs. Collector Current

Typical Curves – DCX143EH PNP Section

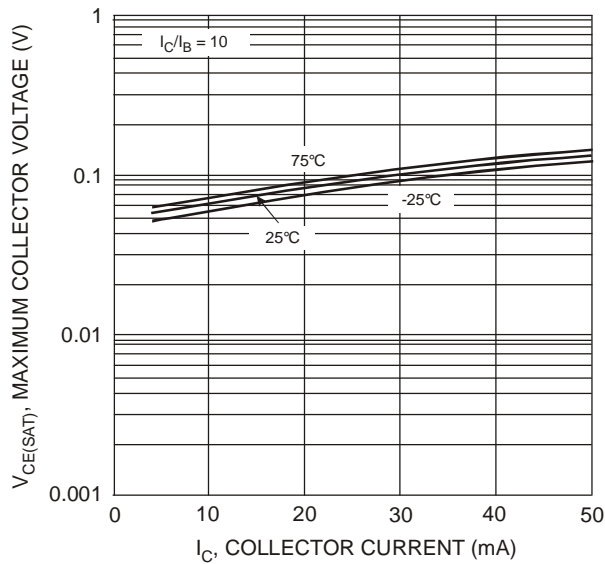

Fig. 7 $V_{CE(SAT)}$ vs. I_C

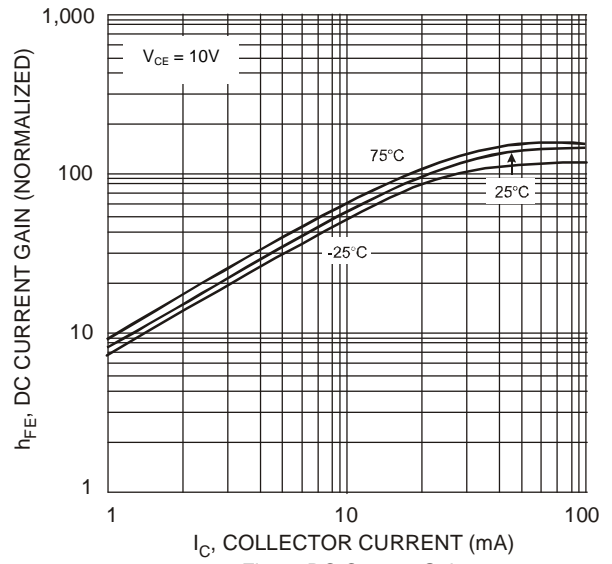

Fig. 8 DC Current Gain

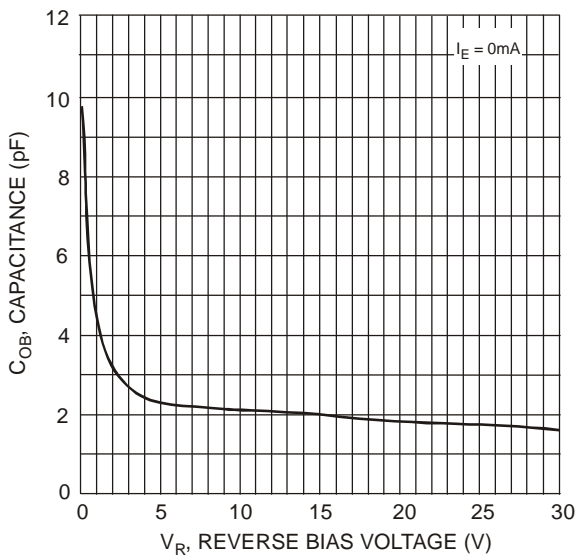

Fig. 9 Output Capacitance

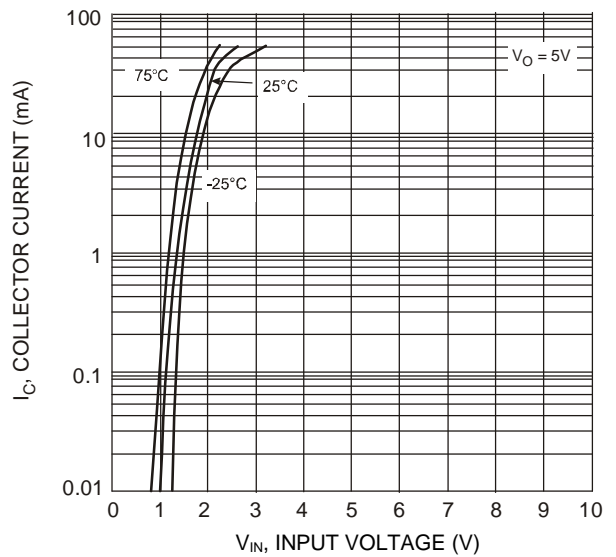

Fig. 10 Collector Current vs. Input Voltage

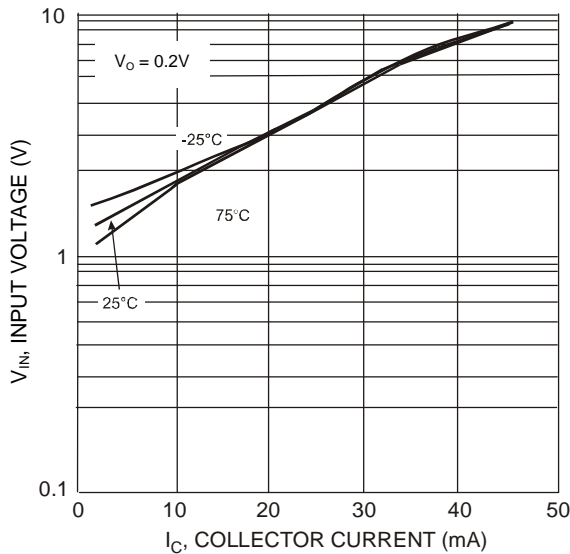
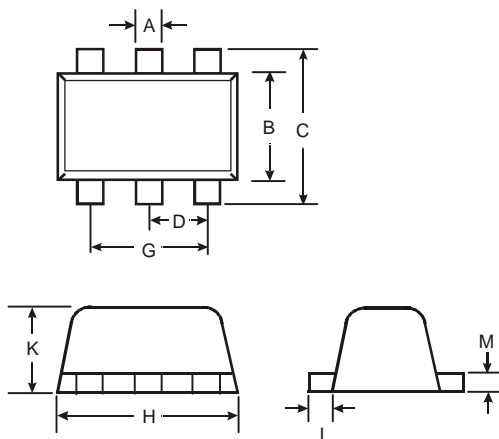

Fig. 11 Input Voltage vs. Collector Current

Package Outline Dimensions

Please see <http://www.diodes.com/package-outlines.html> for the latest version.

SOT563



SOT563			
Dim	Min	Max	Typ
A	0.15	0.30	0.20
B	1.10	1.25	1.20
C	1.55	1.70	1.60
D	-	-	0.50
G	0.90	1.10	1.00
H	1.50	1.70	1.60
K	0.55	0.60	0.60
L	0.10	0.30	0.20
M	0.10	0.18	0.11
All Dimensions in mm			

Suggested Pad Layout

Please see <http://www.diodes.com/package-outlines.html> for the latest version.

SOT563

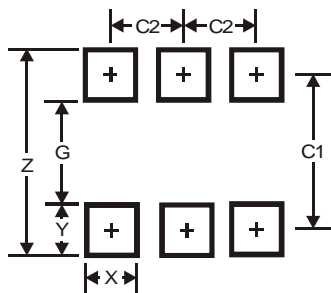

Dimensions	SOT563
Z	2.2
G	1.2
X	0.375
Y	0.5
C1	1.7
C2	0.5

IMPORTANT NOTICE

DIODES INCORPORATED MAKES NO WARRANTY OF ANY KIND, EXPRESS OR IMPLIED, WITH REGARDS TO THIS DOCUMENT, INCLUDING, BUT NOT LIMITED TO, THE IMPLIED WARRANTIES OF MERCHANTABILITY AND FITNESS FOR A PARTICULAR PURPOSE (AND THEIR EQUIVALENTS UNDER THE LAWS OF ANY JURISDICTION).

Diodes Incorporated and its subsidiaries reserve the right to make modifications, enhancements, improvements, corrections or other changes without further notice to this document and any product described herein. Diodes Incorporated does not assume any liability arising out of the application or use of this document or any product described herein; neither does Diodes Incorporated convey any license under its patent or trademark rights, nor the rights of others. Any Customer or user of this document or products described herein in such applications shall assume all risks of such use and will agree to hold Diodes Incorporated and all the companies whose products are represented on Diodes Incorporated website, harmless against all damages.

Diodes Incorporated does not warrant or accept any liability whatsoever in respect of any products purchased through unauthorized sales channel. Should Customers purchase or use Diodes Incorporated products for any unintended or unauthorized application, Customers shall indemnify and hold Diodes Incorporated and its representatives harmless against all claims, damages, expenses, and attorney fees arising out of, directly or indirectly, any claim of personal injury or death associated with such unintended or unauthorized application.

Products described herein may be covered by one or more United States, international or foreign patents pending. Product names and markings noted herein may also be covered by one or more United States, international or foreign trademarks.

This document is written in English but may be translated into multiple languages for reference. Only the English version of this document is the final and determinative format released by Diodes Incorporated.

LIFE SUPPORT

Diodes Incorporated products are specifically not authorized for use as critical components in life support devices or systems without the express written approval of the Chief Executive Officer of Diodes Incorporated. As used herein:

A. Life support devices or systems are devices or systems which:

1. are intended to implant into the body, or
2. support or sustain life and whose failure to perform when properly used in accordance with instructions for use provided in the labeling can be reasonably expected to result in significant injury to the user.

B. A critical component is any component in a life support device or system whose failure to perform can be reasonably expected to cause the failure of the life support device or to affect its safety or effectiveness.

Customers represent that they have all necessary expertise in the safety and regulatory ramifications of their life support devices or systems, and acknowledge and agree that they are solely responsible for all legal, regulatory and safety-related requirements concerning their products and any use of Diodes Incorporated products in such safety-critical, life support devices or systems, notwithstanding any devices- or systems-related information or support that may be provided by Diodes Incorporated. Further, Customers must fully indemnify Diodes Incorporated and its representatives against any damages arising out of the use of Diodes Incorporated products in such safety-critical, life support devices or systems.

Copyright © 2018, Diodes Incorporated

www.diodes.com

Looking for pricing, stock, or lifecycle information?

Click below to explore more details on WIN SOURCE:

 [View DCX114EH-7 on WIN SOURCE](#)

 [Diodes Incorporated](#) Information

Optimize Your Supply Chain with WIN SOURCE Solutions

-  Global Sourcing Solution
-  Obsolete Management
-  Cost Control Management
-  Shortage Management
-  Alternative Solution
-  Excess Inventory Management