



**THE DATASHEET OF
DCX144EK-7**



DUAL COMPLEMENTARY PRE-BIASED TRANSISTOR
Features

- Epitaxial Planar Die Construction
- Built-In Biasing Resistors
- **Available in Lead Free/RoHS Compliant Version (Note 1)**
- **“Green” Device (Note 2)**

Part Number	R1	R2	Marking
DCX124EK	22K Ω	22K Ω	C17
DCX144EK	47K Ω	47K Ω	C20
DCX114YK	10K Ω	47K Ω	C14
DCX123JK	2.2K Ω	47K Ω	C06
DCX114EK	10K Ω	10K Ω	C13
DCX115EK	100K Ω	100K Ω	C15
DCX143TK	4.7K Ω	-	C07
DCX114TK	10K Ω	-	C12

Mechanical Data

- Case: SC-74R (Note 3)
- Case Material: Molded Plastic, “Green” Molding Compound. UL Flammability Classification Rating 94V-0
- Moisture Sensitivity: Level 1 per J-STD-020D
- Terminals: Matte Tin Finish annealed over Copper leadframe (Lead Free Plating) Solderable per MIL-STD-202, Method 208
- Terminal Connections: See Diagram
- Marking Information: See Table and Page 11
- Ordering Information: See Page 11
- Weight: 0.015 grams (approximate)

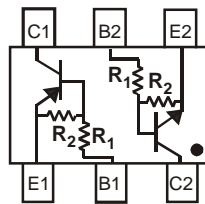

R1, R2 Device Schematic

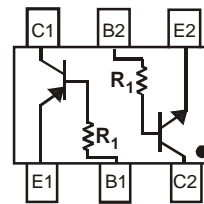

R1 only Device Schematic

Maximum Ratings NPN Section @ $T_A = 25^\circ\text{C}$ unless otherwise specified

Characteristic	Symbol	Value	Unit	
Supply Voltage	V_{CC}	50	V	
Input Voltage	V_{IN}	DCX124EK	-10 to +40	
		DCX144EK	-10 to +40	
		DCX114YK	-6 to +40	
		DCX123JK	-5 to +12	
		DCX114EK	-10 to +40	
		DCX115EK	-10 to +40	
		DCX143TK	-5V max	
		DCX114TK	-5V max	
Output Current	I_O	DCX124EK	30	
		DCX144EK	30	
		DCX114YK	70	
		DCX123JK	100	
		DCX114EK	50	
		DCX115EK	20	
		DCX143TK	100	
DCX114TK	100			
Output Current	All	$I_{C(MAX)}$	100	mA

Thermal Characteristics NPN Section

Characteristic	Symbol	Value	Unit
Power Dissipation (Total) (Note 4)	P_D	300	mW
Thermal Resistance, Junction to Ambient Air (Note 4)	$R_{\theta JA}$	417	$^\circ\text{C/W}$
Operating and Storage Temperature Range	T_J, T_{STG}	-55 to +150	$^\circ\text{C}$

- Notes:
1. No purposefully added lead.
 2. Diodes Inc.'s "Green" policy can be found on our website at http://www.diodes.com/products/lead_free/index.php.
 3. SC-74R and SOT-26 have identical dimensions and the only difference is the location of the pin one indicator. Please see the individual device datasheets for exact details regarding the location of the pin one indicator.
 4. Mounted on FR4 PC Board with recommended pad layout at <http://www.diodes.com/datasheets/ap02001.pdf>. 200mW per element must not be exceeded.

Maximum Ratings PNP Section @T_A = 25°C unless otherwise specified

Characteristic	Symbol	Value	Unit	
Supply Voltage	V _{CC}	50	V	
Input Voltage	V _{IN}	DCX124EK	+10 to -40	
		DCX144EK	+10 to -40	
		DCX114YK	+6 to -40	
		DCX123JK	+5 to -12	
		DCX114EK	+10 to -40	
		DCX115EK	+10 to -40	
		DCX143TK DCX114TK	+5V max +5V max	
Output Current	I _O	DCX124EK	-30	
		DCX144EK	-30	
		DCX114YK	-70	
		DCX123JK	-100	
		DCX114EK	-50	
		DCX115EK	-20	
		DCX143TK DCX114TK	-100 -100	
Output Current	All	I _{C(MAX)}	-100	mA

Thermal Characteristics PNP Section

Characteristic	Symbol	Value	Unit
Power Dissipation (Total) (Note 4)	P _D	300	mW
Thermal Resistance, Junction to Ambient Air (Note 4)	R _{θJA}	833	°C/W
Operating and Storage Temperature Range	T _J , T _{STG}	-55 to +150	°C

Electrical Characteristics NPN Section @T_A = 25°C unless otherwise specified

Characteristic (DDC143TK & DDC114TK only)	Symbol	Min	Typ	Max	Unit	Test Condition
Collector-Base Breakdown Voltage	BV _{CBO}	50	—	—	V	I _C = 50μA
Collector-Emitter Breakdown Voltage	BV _{CEO}	50	—	—	V	I _C = 1mA
Emitter-Base Breakdown Voltage	BV _{EBO}	5	—	—	V	I _E = 50μA
Collector Cutoff Current	I _{CBO}	—	—	0.5	μA	V _{CB} = 50V
Emitter Cutoff Current	I _{EBO}	—	—	0.5	μA	V _{EB} = 4V
Collector-Emitter Saturation Voltage	V _{CE(SAT)}	—	—	0.3	V	I _C /I _B = 2.5mA / 0.25mA – DCX143TK I _C /I _B = 1mA / 0.1mA – DCX114TK
DC Current Transfer Ratio	h _{FE}	100	250	600	—	I _C = 1mA, V _{CE} = 5V
Input Resistor (R ₁) Tolerance	ΔR ₁	-30	—	+30	%	—
Gain-Bandwidth Product*	f _T	—	250	—	MHz	V _{CE} = 10V, I _E = -5mA, f = 100MHz

* Transistor - For Reference Only

Electrical Characteristics NPN Section (continued) @T_A = 25°C unless otherwise specified

Characteristic		Symbol	Min	Typ	Max	Unit	Test Condition
Input Voltage	DCX124EK DCX144EK DCX114YK DCX123JK DCX114EK DCX115EK	V _{I(OFF)}	0.5 0.5 0.3 0.5 0.5 0.5	1.1 1.1 — — 1.1 1.1	—	V	V _{CC} = 5V, I _O = 100μA
	DCX124EK DCX144EK DCX114YK DCX123JK DCX114EK DCX115EK		V _{I(ON)}	—	1.65 1.9 — — 1.9 1.9	3.0 3.0 1.4 1.1 3.0 3.0	V
Output Voltage	DCX124EK DCX144EK DCX114YK DCX123JK DCX114EK DCX115EK	V _{O(ON)}		—	0.1	0.3	V
Input Current	DCX124EK DCX144EK DCX114YK DCX123JK DCX114EK DCX115EK	I _I	—	—	0.36 0.18 0.88 3.6 0.88 0.15	mA	V _I = 5V
Output Current		I _{O(OFF)}	—	—	0.5	μA	V _{CC} = 50V, V _I = 0V
DC Current Gain	DCX124EK DCX144EK DCX114YK DCX123JK DCX114EK DCX115EK	G _I	80 68 68 80 30 82	—	—	—	V _O = 5V, I _O = 5mA V _O = 5V, I _O = 5mA V _O = 5V, I _O = 10mA V _O = 5V, I _O = 10mA V _O = 5V, I _O = 5mA V _O = 5V, I _O = 5mA
Input Resistor (R ₁) Tolerance		ΔR ₁	-30	—	+30	%	—
Resistance Ratio Tolerance		R ₂ /R ₁	-20	—	+20	%	—
Gain-Bandwidth Product*		f _T	—	250	—	MHz	V _{CE} = 10V, I _E = -5mA, f = 100MHz

* Transistor - For Reference Only

Electrical Characteristics PNP Section @T_A = 25°C unless otherwise specified

Characteristic (DCX143TK & DCX114TK only)		Symbol	Min	Typ	Max	Unit	Test Condition
Collector-Base Breakdown Voltage		BV _{CB0}	-50	—	—	V	I _C = -50μA
Collector-Emitter Breakdown Voltage		BV _{CEO}	-50	—	—	V	I _C = -1mA
Emitter-Base Breakdown Voltage		BV _{EBO}	-5	—	—	V	I _E = -50μA
Collector Cutoff Current		I _{CB0}	—	—	-0.5	μA	V _{CB} = -50V
Emitter Cutoff Current		I _{EBO}	—	—	-0.5	μA	V _{EB} = -4V
Collector-Emitter Saturation Voltage		V _{CE(SAT)}	—	—	-0.3	V	I _C /I _B = -2.5mA / -0.25mA - DCX143TK I _C /I _B = -1mA / -0.1mA - DCX114TK
DC Current Transfer Ratio		h _{FE}	100	250	600	—	I _C = -1mA, V _{CE} = -5V
Input Resistor (R ₁) Tolerance		ΔR ₁	-30	—	+30	%	—
Gain-Bandwidth Product*		f _T	—	250	—	MHz	V _{CE} = -10V, I _E = 5mA, f = 100MHz

* Transistor - For Reference Only

Electrical Characteristics PNP Section (Continued) @T_A = 25°C unless otherwise specified

Characteristic		Symbol	Min	Typ	Max	Unit	Test Condition
Input Voltage	DCX124EK DCX144EK DCX114YK DCX123JK DCX114EK DCX115EK	V _{I(OFF)}	-0.5 -0.5 -0.3 -0.5 -0.5 -0.5	-1.1 -1.1 — — -1.1 -1.1	— — — — — —	V	V _{CC} = -5V, I _O = -100μA
	DCX124EK DCX144EK DCX114YK DCX123JK DCX114EK DCX115EK	V _{I(ON)}	— — — — -1.9 -1.9	-1.9 -1.9 — — -3.0 -3.0	-3.0 -3.0 -1.4 -1.1 -3.0 -3.0	V	V _O = -0.3V, I _O = -5mA V _O = -0.3V, I _O = -2mA V _O = -0.3V, I _O = -1mA V _O = -0.3V, I _O = -5mA V _O = -0.3V, I _O = -10mA V _O = -0.3V, I _O = -1mA
Output Voltage	DCX124EK DCX144EK DCX114YK DCX123JK DCX114EK DCX115EK	V _{O(ON)}	—	-0.1	-0.3	V	I _O /I _I = -10mA / -0.5mA I _O /I _I = -10mA / -0.5mA I _O /I _I = -5mA / -0.25mA I _O /I _I = -5mA / -0.25mA I _O /I _I = -10mA / -0.5mA I _O /I _I = -5mA / -0.25mA
Input Current	DCX124EK DCX144EK DCX114YK DCX123JK DCX114EK DCX115EK	I _I	—	—	-0.36 -0.18 -0.88 -3.6 -0.88 -0.15	mA	V _I = -5V
Output Current		I _{O(OFF)}	—	—	-0.5	μA	V _{CC} = 50V, V _I = 0V
DC Current Gain	DCX124EK DCX144EK DCX114YK DCX123JK DCX114EK DCX115EK	G _I	80 68 68 80 30 82	—	—	—	V _O = -5V, I _O = -5mA V _O = -5V, I _O = -5mA V _O = -5V, I _O = -10mA V _O = -5V, I _O = -10mA V _O = -5V, I _O = -5mA V _O = -5V, I _O = -5mA
Input Resistor (R ₁) Tolerance		ΔR ₁	-30	—	+30	%	—
Resistance Ratio Tolerance		R ₂ /R ₁	-20	—	+20	%	—
Gain-Bandwidth Product*		f _T	—	250	—	MHZ	V _{CE} = -10V, I _E = -5mA, f = 100MHZ

*Transistor - For Reference Only

Typical Curves – Total Device

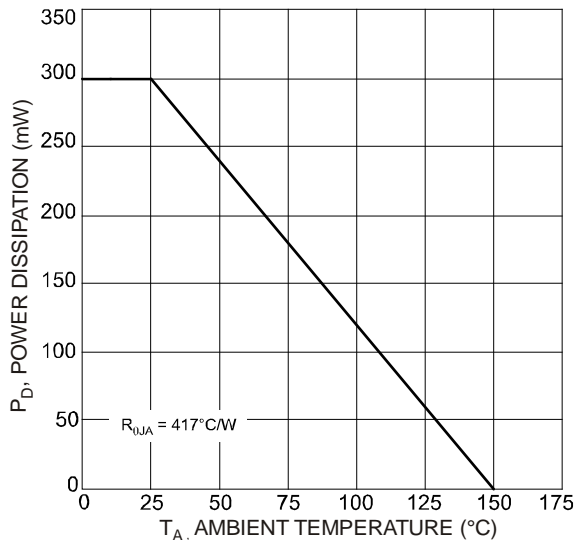

Fig. 1 Power Dissipation vs. Ambient Temperature

Typical Curves – DCX124EK PNP Section

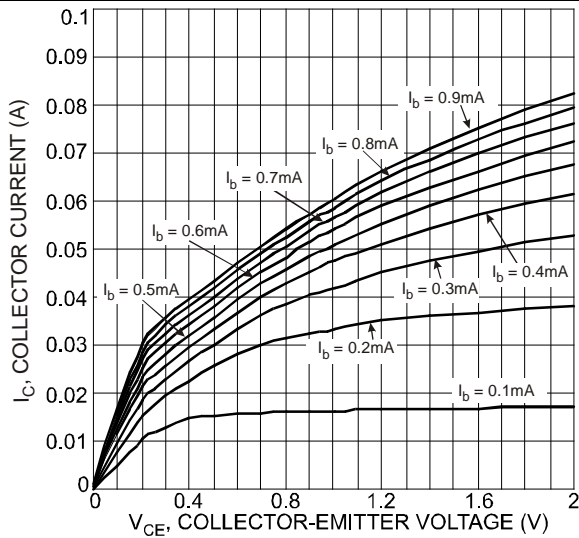

Fig. 2 Typical Collector Current vs. Collector-Emitter Voltage

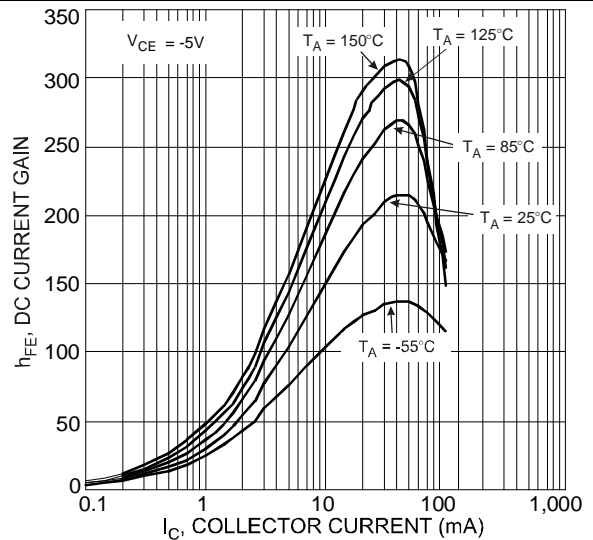

Fig. 3 Typical DC Current Gain vs. Collector Current

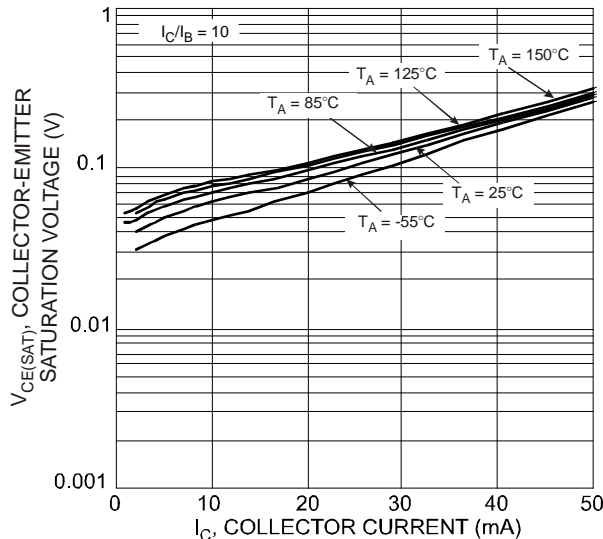

Fig. 4 Typical Collector-Emitter Saturation Voltage vs. Collector Current

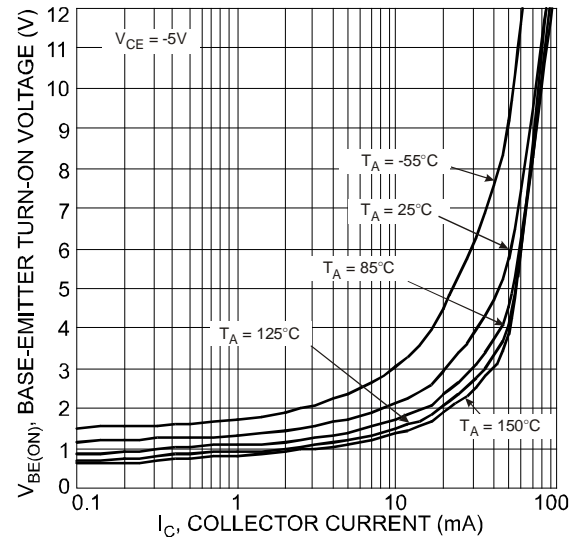

Fig. 5 Typical Base-Emitter Turn-On Voltage vs. Collector Current

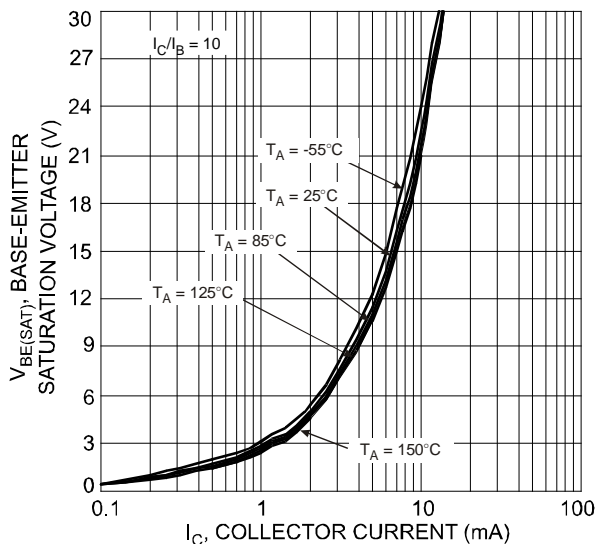

Fig. 6 Typical Base-Emitter Saturation Voltage vs. Collector Current

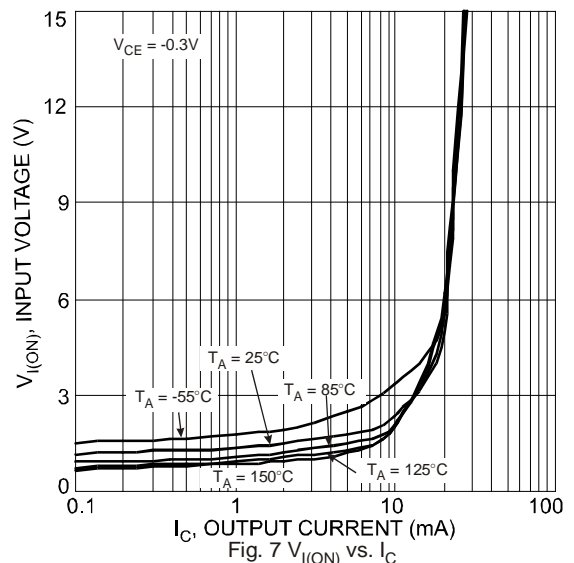

Fig. 7 $V_{I(ON)}$ vs. I_C

Typical Curves – DCX124EK NPN Section

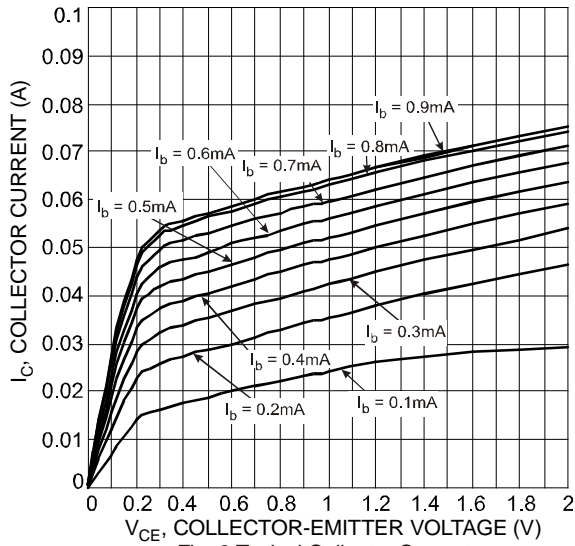

Fig. 8 Typical Collector Current vs. Collector-Emitter Voltage

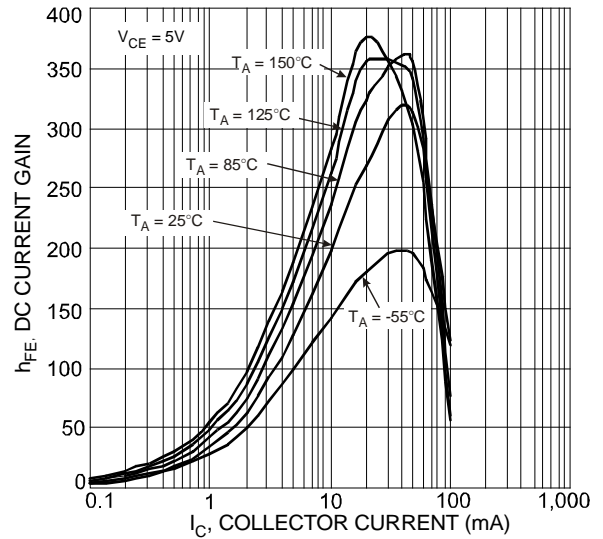

Fig. 9 Typical DC Current Gain vs. Collector Current

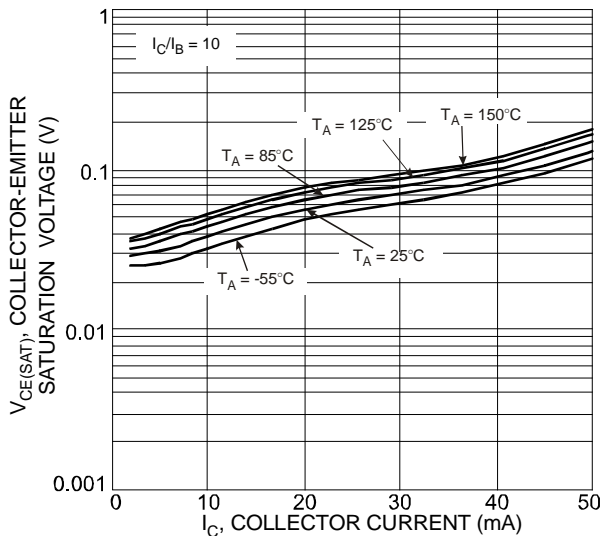

Fig. 10 Collector-Emitter Saturation Voltage vs. Collector Current

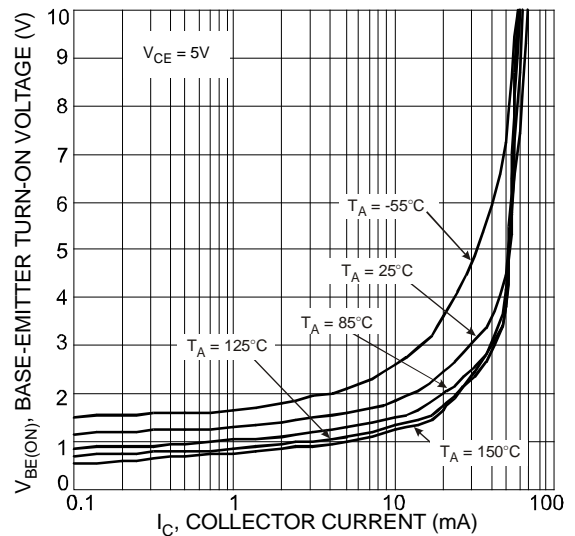

Fig. 11 Base-Emitter Turn-On Voltage vs. Collector Current

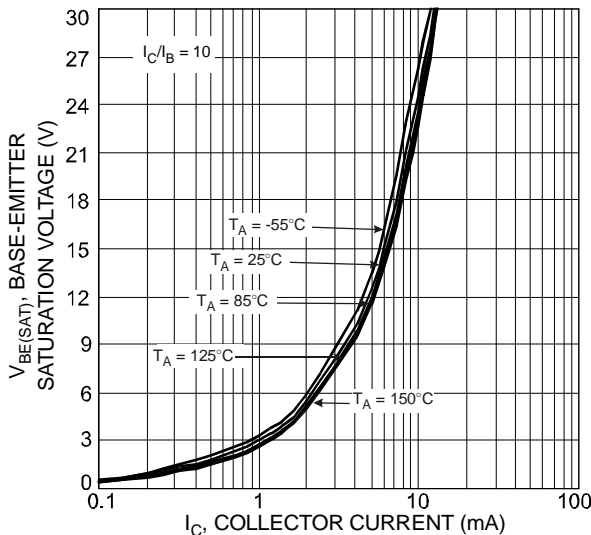

Fig. 12 Typical Base-Emitter Saturation Voltage vs. Collector Current

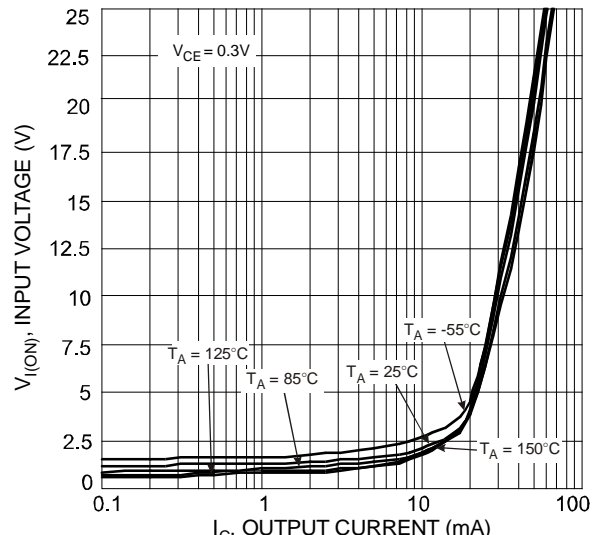

Fig. 13 $V_{I(ON)}$ vs. I_C

Typical Curves – DCX123JK PNP Section

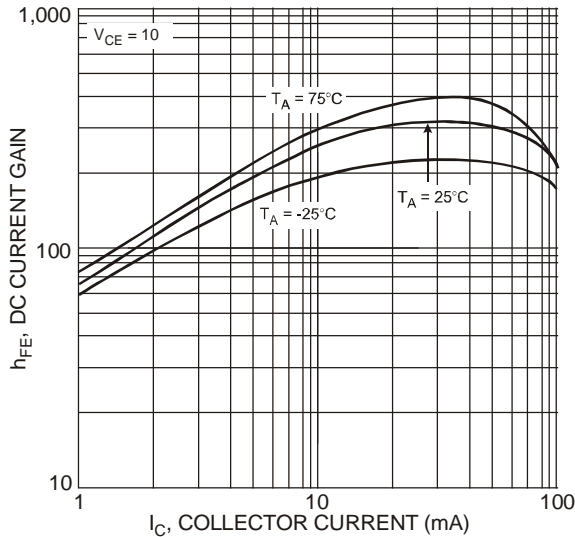

Fig. 14 Typical DC Current Gain vs. Collector Current

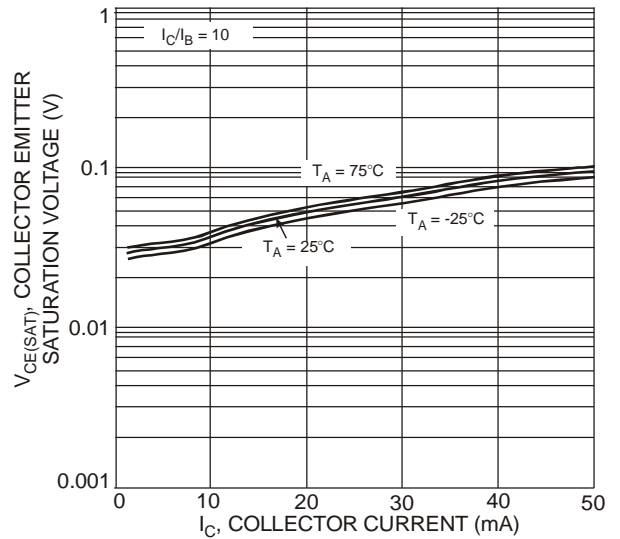

Fig. 15 Typical Collector Emitter Saturation Voltage vs. Collector Current

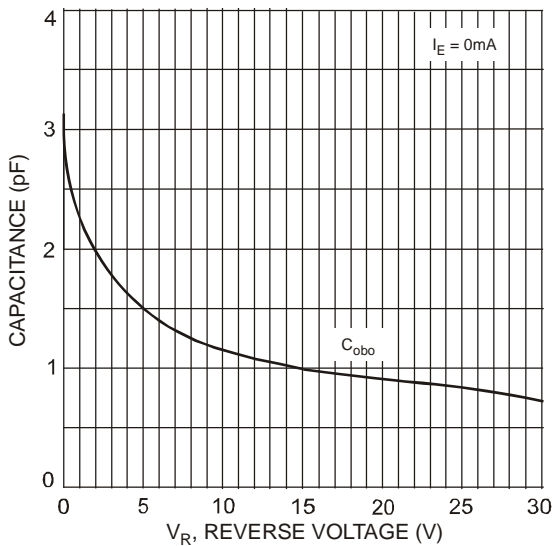

Fig. 16 Typical Capacitance Characteristics

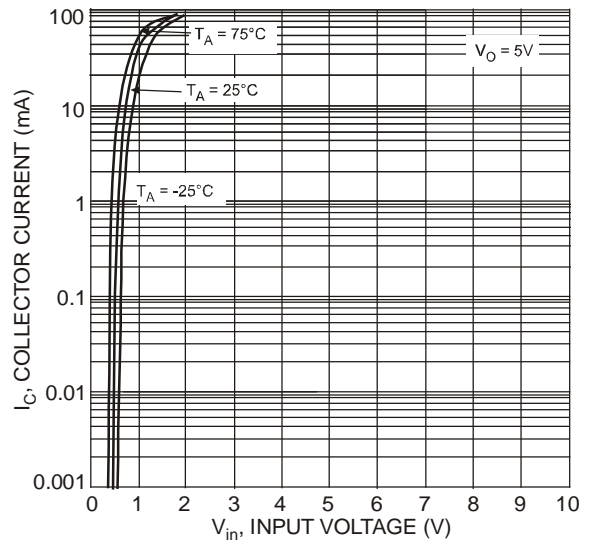

Fig. 17 Collector Current vs. Input Voltage

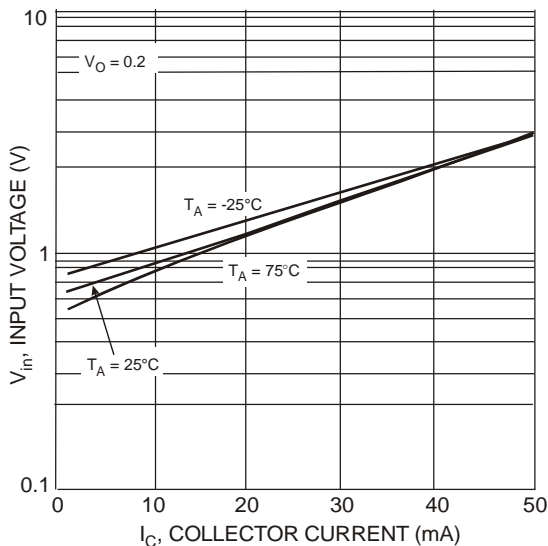

Fig. 18 Input Voltage vs. Collector Current

Typical Curves – DCX123JK NPN Section

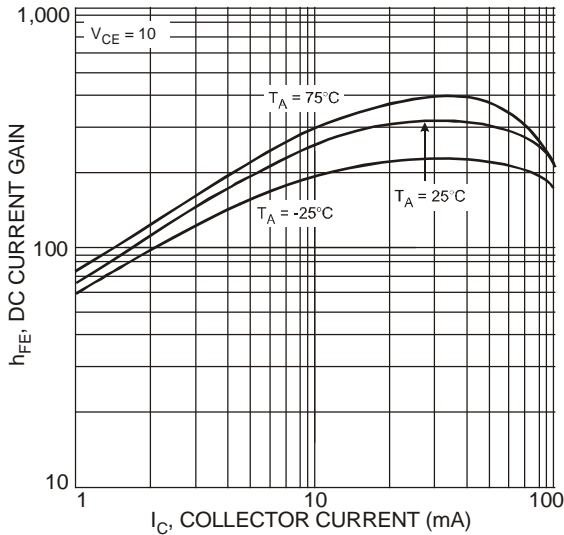

Fig. 19 Typical DC Current Gain vs. Collector Current

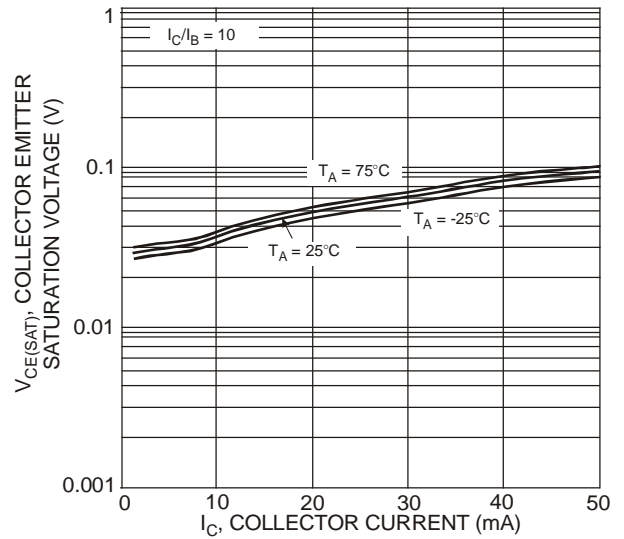

Fig. 20 Collector Emitter Saturation Voltage vs. Collector Current

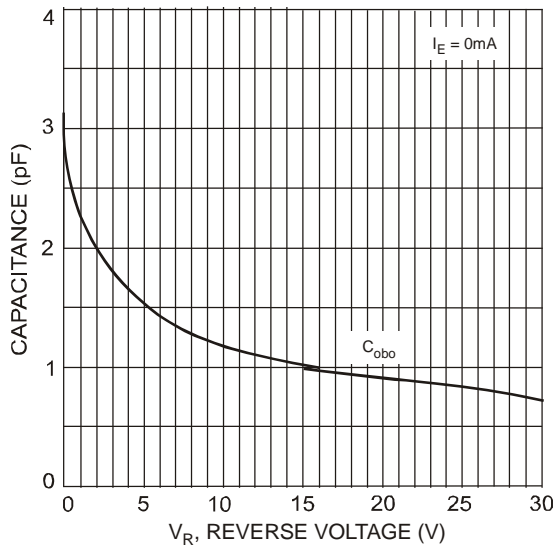

Fig. 21 Typical Capacitance Characteristics

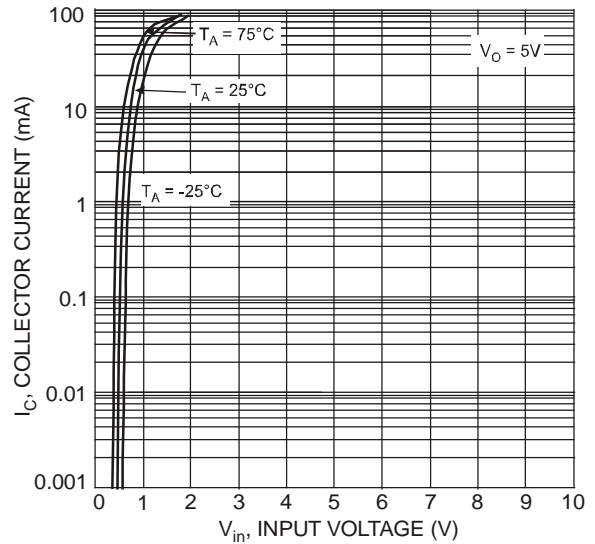

Fig. 22 Collector Current vs. Input Voltage

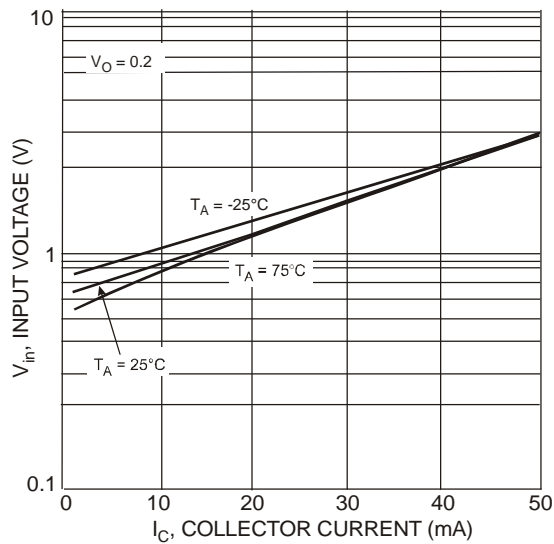

Fig. 23 Input Voltage vs. Collector Current

Typical Curves – DCX114TK PNP Section

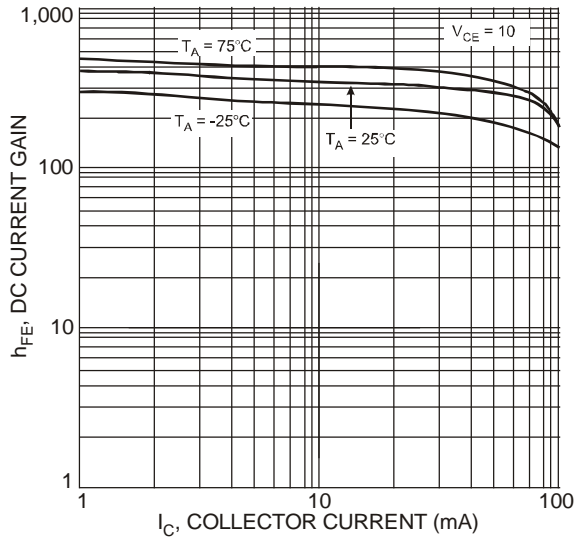

Fig. 24 Typical DC Current Gain vs. Collector Current

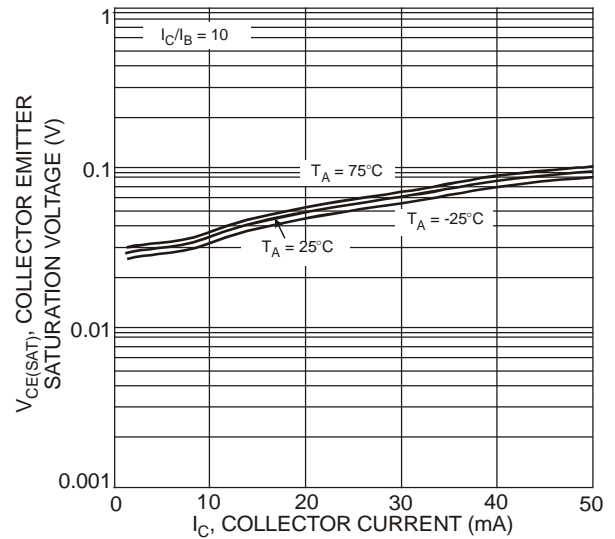

Fig. 25 Typical Collector Emitter Saturation Voltage vs. Collector Current

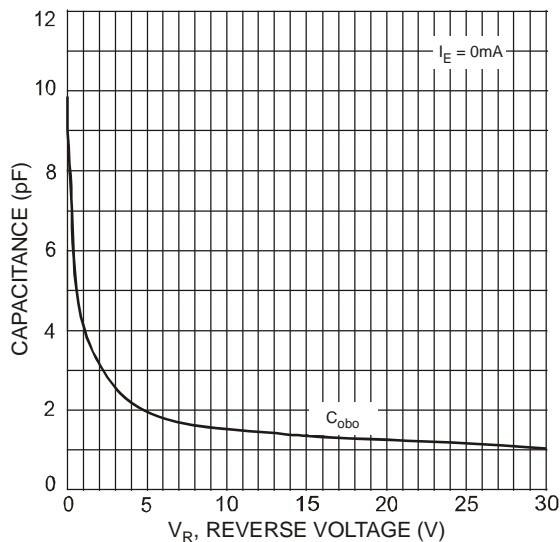

Fig. 26 Typical Capacitance Characteristics

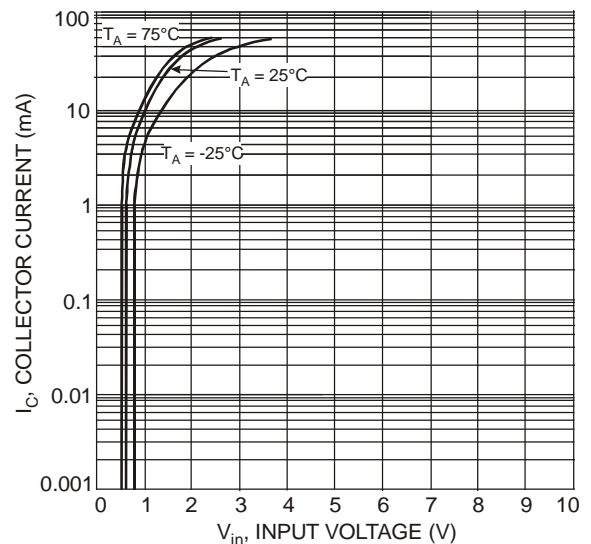

Fig. 27 Collector Current vs. Input Voltage

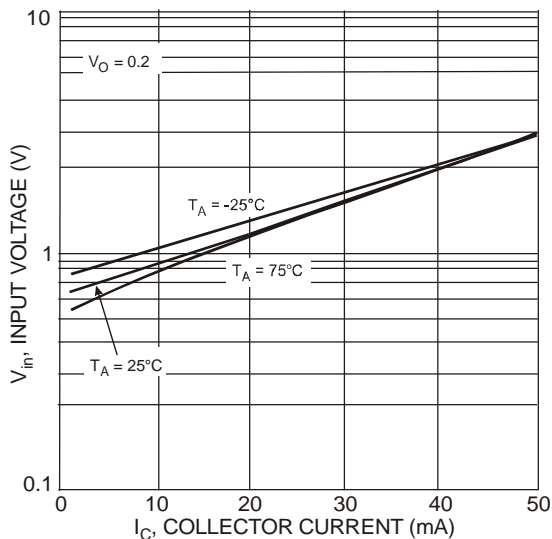

Fig. 28 Input Voltage vs. Collector Current

Typical Curves- DCX114TK NPN Section

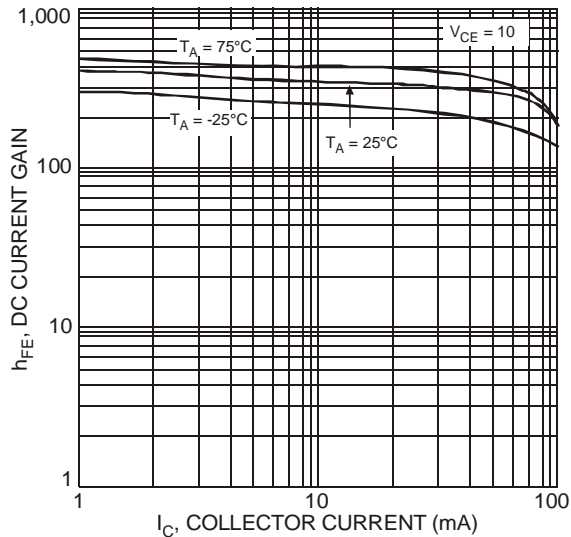

Fig. 29 Typical DC Current Gain vs. Collector Current

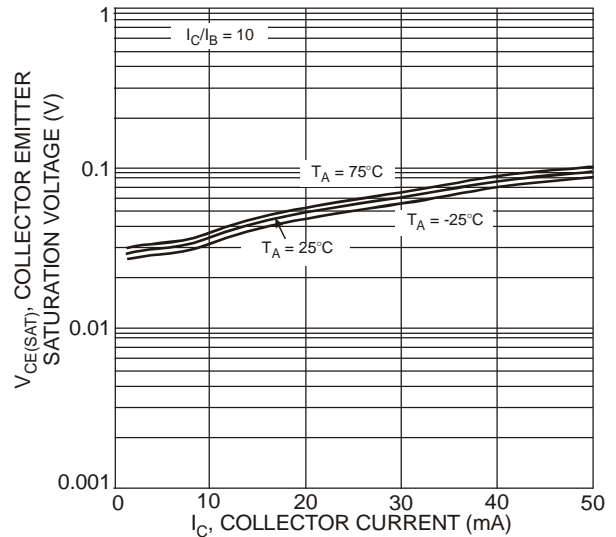

Fig. 30 Typical Collector Emitter Saturation Voltage vs. Collector Current

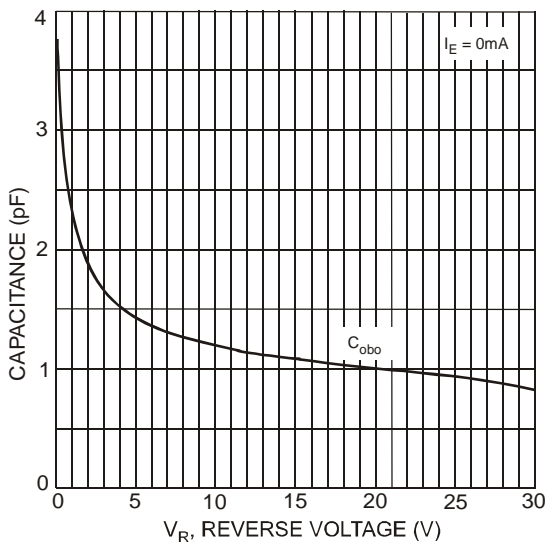

Fig. 31 Typical Capacitance Characteristics

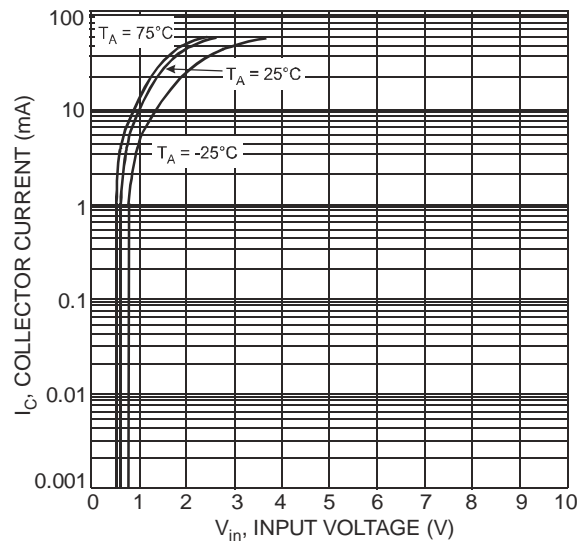

Fig. 32 Collector Current vs. Input Voltage

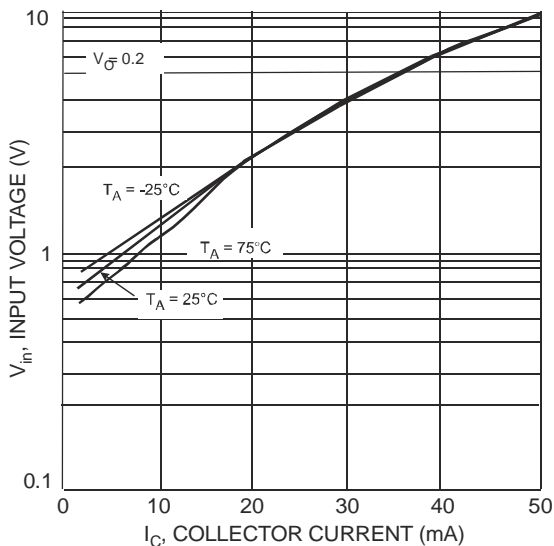

Fig. 33 Input Voltage vs. Collector Current

Ordering Information (Notes 5 & 6)

Part Number	Case	Packaging
DCX124EK-7	SC-74R	3000/Tape & Reel
DCX144EK-7	SC-74R	3000/Tape & Reel
DCX114YK-7	SC-74R	3000/Tape & Reel
DCX123JK-7	SC-74R	3000/Tape & Reel
DCX114EK-7	SC-74R	3000/Tape & Reel
DCX115EK-7	SC-74R	3000/Tape & Reel
DCX143TK-7	SC-74R	3000/Tape & Reel
DCX114TK-7	SC-74R	3000/Tape & Reel

- Notes: 5. For packaging details, go to our website at <http://www.diodes.com/datasheets/ap02007.pdf>.
 6. For Lead Free/RoHS Compliant version part numbers, please add "-F" suffix to the part numbers above. Example: DCX114TK-7-F.

Marking Information

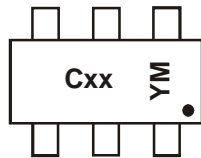

Cxx = Product Type Marking Code (See Page 1)
 YM = Date Code Marking
 Y = Year (ex: T = 2006)
 M = Month (ex: 9 = September)

Date Code Key

Year	2006	2007	2008	2009	2010	2011	2012	2013	2014	2015
Code	T	U	V	W	X	Y	Z	A	B	C

Month	Jan	Feb	Mar	Apr	May	Jun	Jul	Aug	Sep	Oct	Nov	Dec
Code	1	2	3	4	5	6	7	8	9	O	N	D

Package Outline Dimensions

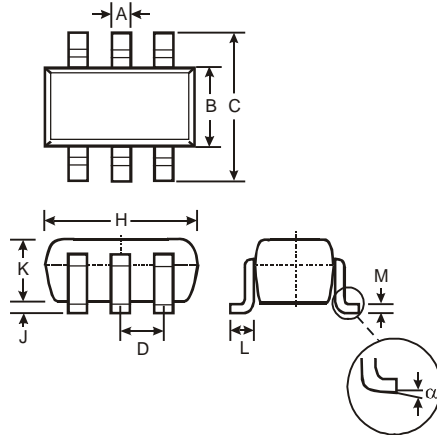

SC-74R			
Dim	Min	Max	Typ
A	0.35	0.50	0.38
B	1.50	1.70	1.60
C	2.70	3.00	2.80
D	—	—	0.95
H	2.90	3.10	3.00
J	0.013	0.10	0.05
K	1.00	1.30	1.10
L	0.35	0.55	0.40
M	0.10	0.20	0.15
α	0°	8°	—
All Dimensions in mm			

Suggested Pad Layout

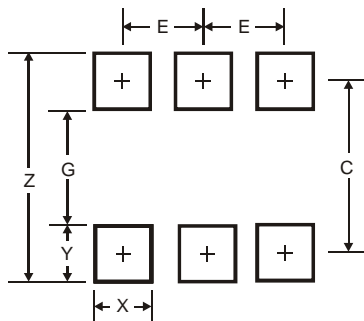

Dimensions	Value (in mm)
Z	3.20
G	1.60
X	0.55
Y	0.80
C	2.40
E	0.95

IMPORTANT NOTICE

Diodes Incorporated and its subsidiaries reserve the right to make modifications, enhancements, improvements, corrections or other changes without further notice to any product herein. Diodes Incorporated does not assume any liability arising out of the application or use of any product described herein; neither does it convey any license under its patent rights, nor the rights of others. The user of products in such applications shall assume all risks of such use and will agree to hold Diodes Incorporated and all the companies whose products are represented on our website, harmless against all damages.

LIFE SUPPORT

Diodes Incorporated products are not authorized for use as critical components in life support devices or systems without the expressed written approval of the President of Diodes Incorporated.

Looking for pricing, stock, or lifecycle information?

Click below to explore more details on WIN SOURCE:

-  [View DCX144EK-7 on WIN SOURCE](#)
-  [Diodes Incorporated Information](#)

Optimize Your Supply Chain with WIN SOURCE Solutions

-  Global Sourcing Solution
-  Obsolete Management
-  Cost Control Management
-  Shortage Management
-  Alternative Solution
-  Excess Inventory Management