

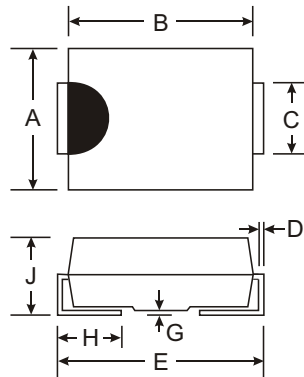

### Features

- Schottky Barrier Chip
- Guard Ring Die Construction for Transient Protection
- Ideally Suited for Automatic Assembly
- Low Power Loss, High Efficiency
- Surge Overload Rating to 30A Peak
- For Use in Low Voltage, High Frequency Inverters, Free Wheeling, and Polarity Protection Application
- High Temperature Soldering: 260°C/10 Second at Terminal
- Plastic Material: UL Flammability Classification Rating 94V-0



Dim	SMA		SMB	
	Min	Max	Min	Max
A	2.29	2.92	3.30	3.94
B	4.00	4.60	4.06	4.57
C	1.27	1.63	1.96	2.21
D	0.15	0.31	0.15	0.31
E	4.80	5.59	5.00	5.59
G	0.10	0.20	0.10	0.20
H	0.76	1.52	0.76	1.52
J	2.01	2.62	2.00	2.62
All Dimensions in mm				

No Suffix Designates SMA Package  
 "B" Suffix Designates SMB Package

### Mechanical Data

- Case: SMA / SMB, Molded Plastic
- Terminals: Solder Plated Terminal - Solderable per MIL-STD-202, Method 208
- Polarity: Cathode Band or Cathode Notch
- SMA Weight: 0.064 grams (approx.)
- SMB Weight: 0.093 grams (approx.)
- Mounting Position: Any
- Marking: Type Number

### Maximum Ratings and Electrical Characteristics @ T<sub>A</sub> = 25°C unless otherwise specified

Single phase, half wave, 60Hz, resistive or inductive load.  
 For capacitive load, derate current by 20%.

Characteristic	Symbol	B170/B	B180/B	B190/B	B1100/B	Unit
Peak Repetitive Reverse Voltage Working Peak Reverse Voltage DC Blocking Voltage	V <sub>RRM</sub> V <sub>RWM</sub> V <sub>R</sub>	70	80	90	100	V
RMS Reverse Voltage	V <sub>R(RMS)</sub>	49	56	63	70	V
Average Rectified Output Current @ T <sub>T</sub> = 125°C	I <sub>O</sub>	1.0				A
Non-Repetitive Peak Forward Surge Current 8.3ms single half sine-wave superimposed on rated load (JEDEC Method)	I <sub>FSM</sub>	30				A
Forward Voltage @ I <sub>F</sub> = 1.0A @ T <sub>A</sub> = 25°C @ T <sub>A</sub> = 100°C	V <sub>FM</sub>	0.79 0.69				V
Peak Reverse Current at Rated DC Blocking Voltage @ T <sub>A</sub> = 25°C @ T <sub>A</sub> = 100°C	I <sub>RM</sub>	0.5 5.0				mA
Typical Junction Capacitance (Note 2)	C <sub>j</sub>	80				pF
Typical Thermal Resistance Junction to Terminal (Note 1)	R <sub>θJT</sub>	25				K/W
Operating and Storage Temperature Range	T <sub>j</sub> , T <sub>STG</sub>	-65 to +150				°C

- Notes: 1. Valid provided that terminals are kept at ambient temperature.  
 2. Measured at 1.0MHz and applied reverse voltage of 4.0V DC.

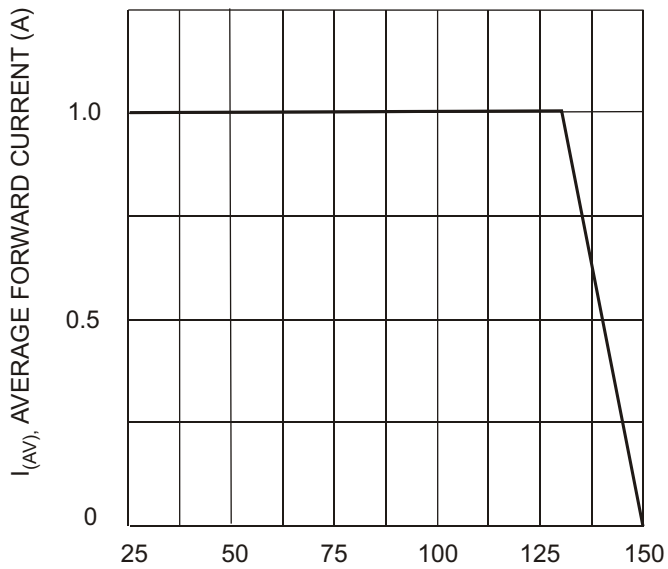

$T_T$ , TERMINAL TEMPERATURE (°C)  
Fig. 1 Forward Current Derating Curve

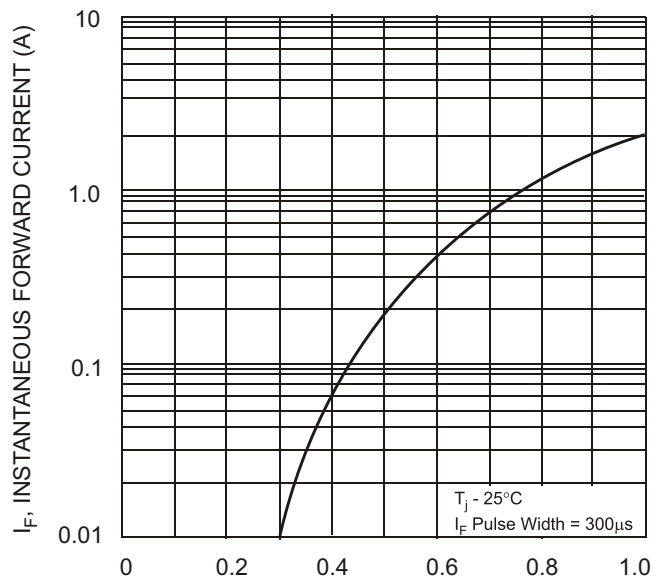

$V_F$ , INSTANTANEOUS FORWARD VOLTAGE (V)  
Fig. 2 Typical Forward Characteristics

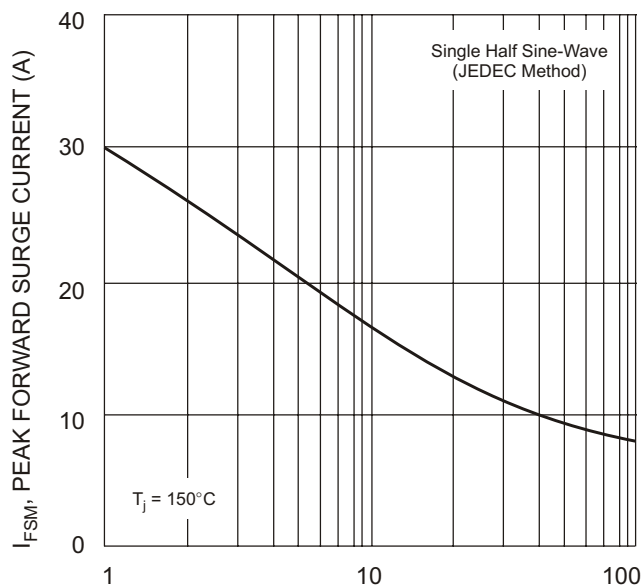

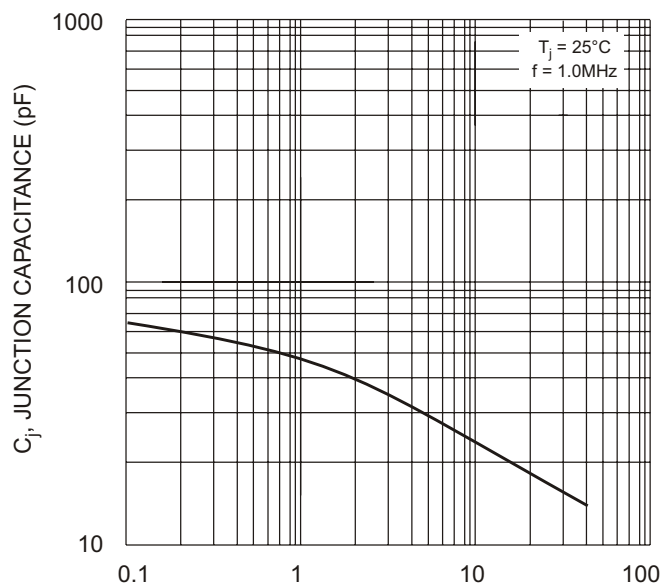

NUMBER OF CYCLES AT 60 Hz  
Fig. 3 Max Non-Repetitive Peak Fwd Surge Current



$V_R$ , REVERSE VOLTAGE (V)  
Fig. 4 Typical Junction Capacitance

## Looking for pricing, stock, or lifecycle information?

Click below to explore more details on WIN SOURCE:

-  [View B1100-13 on WIN SOURCE](#)
-  [Diodes Incorporated Information](#)

## Optimize Your Supply Chain with WIN SOURCE Solutions

-  Global Sourcing Solution
-  Obsolete Management
-  Cost Control Management
-  Shortage Management
-  Alternative Solution
-  Excess Inventory Management