

Standard Recovery Diodes, (Stud Version), 70 A



DO-5 (DO-203AB)

FEATURES

- High surge current capability
- Designed for a wide range of applications
- Stud cathode and stud anode version
- Leaded version available
- Types up to 1600 V V_{RRM}
- Designed and qualified for industrial level
- Material categorization: for definitions of compliance please see www.vishay.com/doc?99912

RoHS
COMPLIANT

TYPICAL APPLICATIONS

- Converters
- Power supplies
- Machine tool controls
- Battery charges

PRIMARY CHARACTERISTICS

$I_{F(AV)}$	70 A
Package	DO-5 (DO-203AB)
Circuit configuration	Single

MAJOR RATINGS AND CHARACTERISTICS

PARAMETER	TEST CONDITIONS	70HF(R)		UNITS
		10 TO 120	140/160	
$I_{F(AV)}$		70	70	A
	T_C	140	110	°C
$I_{F(RMS)}$		110	110	A
I_{FSM}	50 Hz	1200	1200	A
	60 Hz	1250	1250	
I^2t	50 Hz	7100	7100	A ² s
	60 Hz	6450	6450	
V_{RRM}	Range	100 to 1200	1400 to 1600	V
T_J		-65 to +180	-65 to +150	°C

ELECTRICAL SPECIFICATIONS

VOLTAGE RATINGS

TYPE NUMBER	VOLTAGE CODE	V_{RRM} , MAXIMUM REPETITIVE PEAK REVERSE VOLTAGE V	V_{RSM} , MAXIMUM NON-REPETITIVE PEAK REVERSE VOLTAGE V	$V_{R(BR)}$, MINIMUM AVALANCHE VOLTAGE V	I_{RRM} MAXIMUM AT $T_J = T_J$ MAXIMUM mA
VS-70HF(R)	10	100	200	200	15
	20	200	300	300	
	30	300	400	400	
	40	400	500	500	
	60	600	720	725	9
	80	800	960	950	
	100	1000	1200	1150	
	120	1200	1440	1350	
	140	1400	1650	1550	
160	1600	1900	1750	4.5	



FORWARD CONDUCTION							
PARAMETER	SYMBOL	TEST CONDITIONS		70HF(R)		UNITS	
				10 to 120	140/160		
Maximum average forward current at case temperature	$I_{F(AV)}$	180° conduction, half sine wave		70		A	
				140	110	°C	
Maximum RMS forward current	$I_{F(RMS)}$			110		A	
Maximum peak, one cycle forward, non-repetitive surge current	I_{FSM}	t = 10 ms	No voltage reappplied	Sinusoidal half wave, initial $T_J = T_J$ maximum		1200	A
		t = 8.3 ms				1250	
		t = 10 ms	100 % V_{RRM} reappplied			1000	
		t = 8.3 ms				1050	
Maximum I^2t for fusing	I^2t	t = 10 ms	No voltage reappplied	7100	A ² s		
		t = 8.3 ms		6450			
		t = 10 ms	100 % V_{RRM} reappplied	5000			
		t = 8.3 ms		4550			
Maximum $I^2\sqrt{t}$ for fusing	$I^2\sqrt{t}$	t = 0.1 ms to 10 ms, no voltage reappplied		71 000	A ² √s		
Low level value of threshold voltage	$V_{F(TO)1}$	(16.7 % $\times \pi \times I_{F(AV)} < I < \pi \times I_{F(AV)}$, $T_J = T_J$ maximum)		0.79	V		
High level value of threshold voltage	$V_{F(TO)2}$	(I > $\pi \times I_{F(AV)}$, $T_J = T_J$ maximum)		1.00			
Low level value of forward slope resistance	r_{f1}	(16.7 % $\times \pi \times I_{F(AV)} < I < \pi \times I_{F(AV)}$, $T_J = T_J$ maximum)		2.33	mΩ		
High level value of forward slope resistance	r_{f2}	(I > $\pi \times I_{F(AV)}$, $T_J = T_J$ maximum)		1.53			
Maximum forward voltage drop	V_{FM}	$I_{pk} = 220$ A, $T_J = 25$ °C, $t_p = 400$ μs rectangular wave		1.35	1.46	V	

THERMAL AND MECHANICAL SPECIFICATIONS						
PARAMETER	SYMBOL	TEST CONDITIONS		70HF(R)		UNITS
				10 to 120	140/160	
Maximum junction and storage temperature range	T_J, T_{Stg}			-65 to +180	-65 to +150	°C
Maximum thermal resistance, junction to case	R_{thJC}	DC operation		0.45		K/W
Thermal resistance, case to heatsink	R_{thCS}	Mounting surface, smooth, flat and greased		0.25		
Maximum allowable mounting torque (+0 %, -10 %)		Not lubricated thread, tightening on nut ⁽¹⁾		3.4 (30)		N · m (lbf · in)
		Lubricated thread, tightening on nut ⁽¹⁾		2.3 (20)		
		Not lubricated thread, tightening on hexagon ⁽²⁾		4.2 (37)		
		Lubricated thread, tightening on hexagon ⁽²⁾		3.2 (28)		
Approximate weight				17		g
				0.6		oz.
Case style		See dimensions - link at the end of datasheet		DO-5 (DO-203AB)		

Notes

- (1) Recommended for pass-through holes
- (2) Recommended for holed threaded heatsinks

ΔR_{thJC} CONDUCTION				
CONDUCTION ANGLE	SINUSOIDAL CONDUCTION	RECTANGULAR CONDUCTION	TEST CONDITIONS	UNITS
180°	0.08	0.06	$T_J = T_J$ maximum	K/W
120°	0.10	0.11		
90°	0.13	0.14		
60°	0.19	0.20		
30°	0.30	0.30		

Note

- The table above shows the increment of thermal resistance R_{thJC} when devices operate at different conduction angles than DC

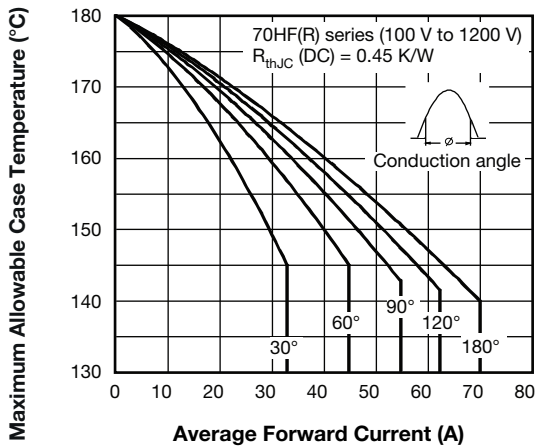

Fig. 1 - Current Ratings Characteristics

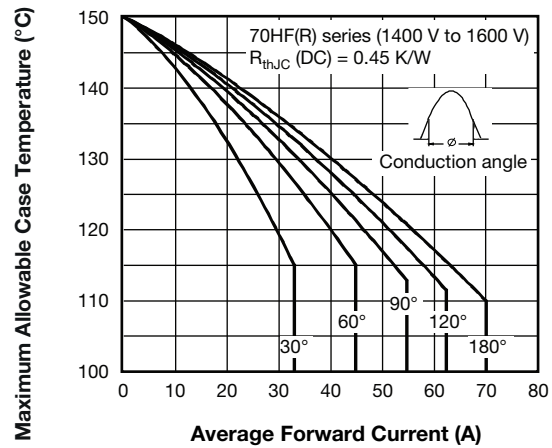

Fig. 3 - Current Ratings Characteristics

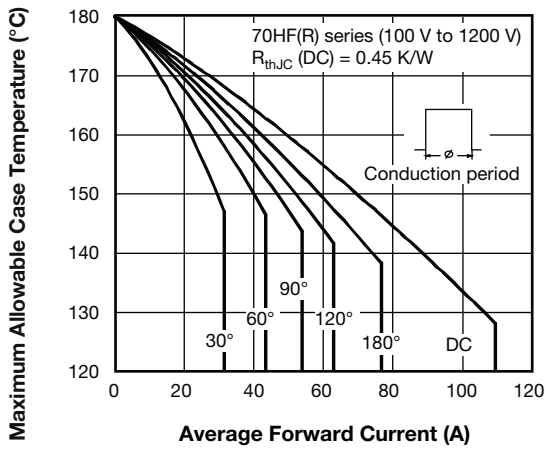

Fig. 2 - Current Ratings Characteristics

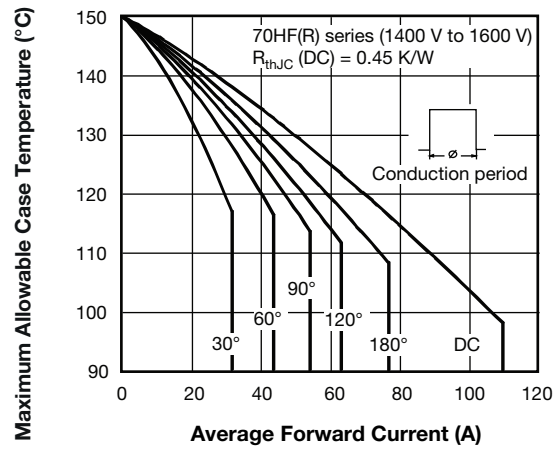

Fig. 4 - Current Ratings Characteristics

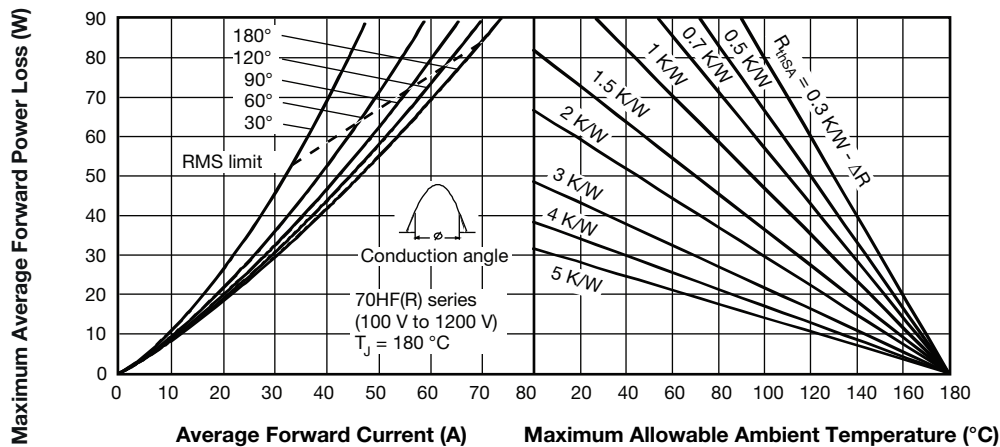

Fig. 5 - Forward Power Loss Characteristics

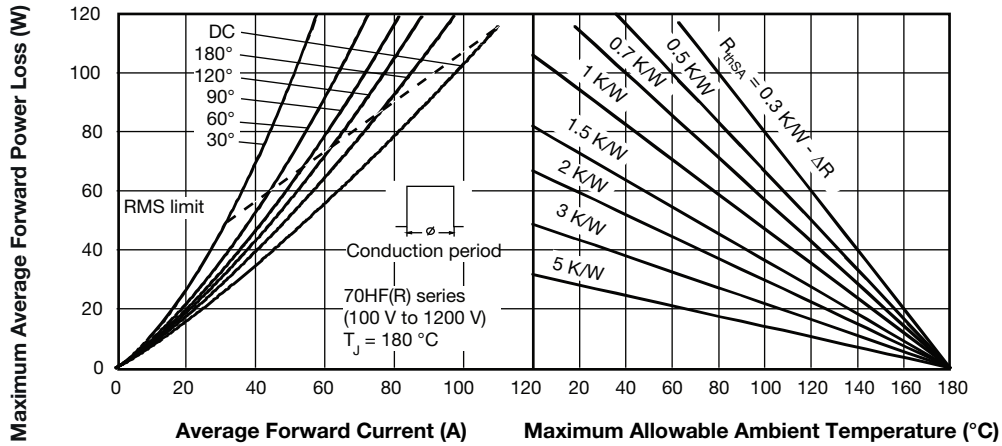

Fig. 6 - Forward Power Loss Characteristics

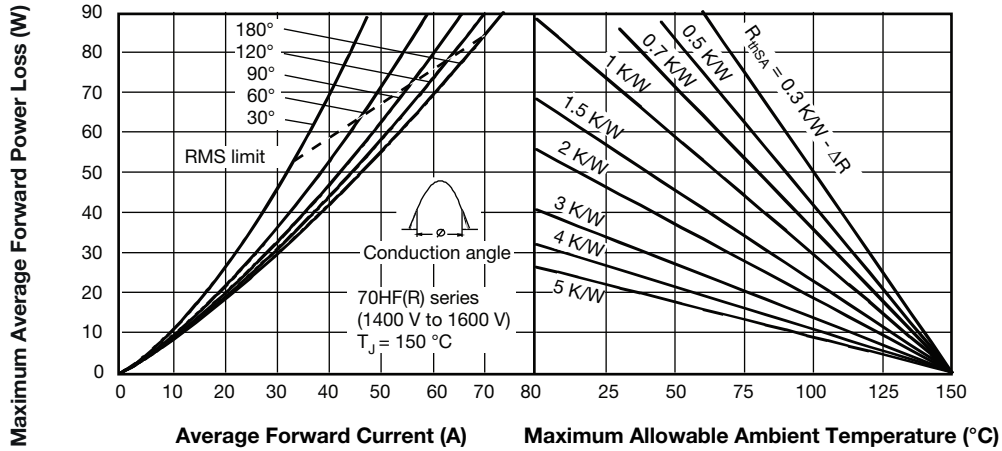

Fig. 7 - Forward Power Loss Characteristics

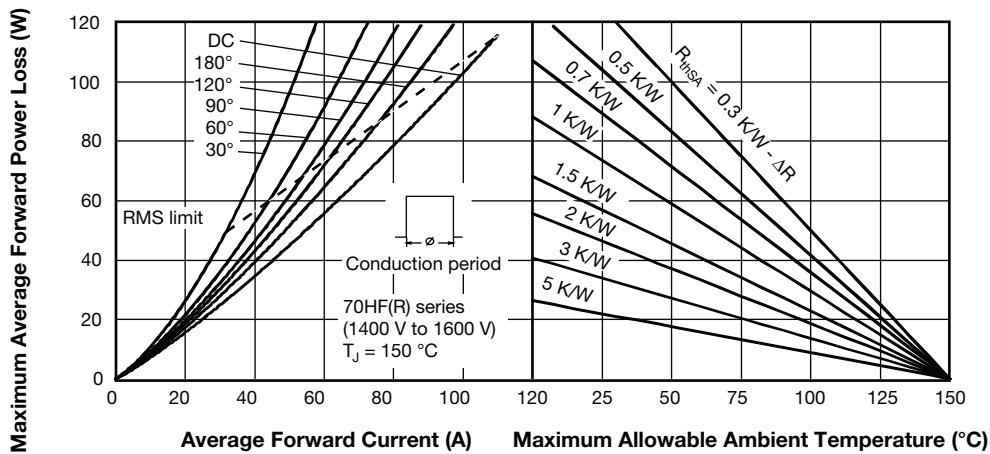

Fig. 8 - Forward Power Loss Characteristics

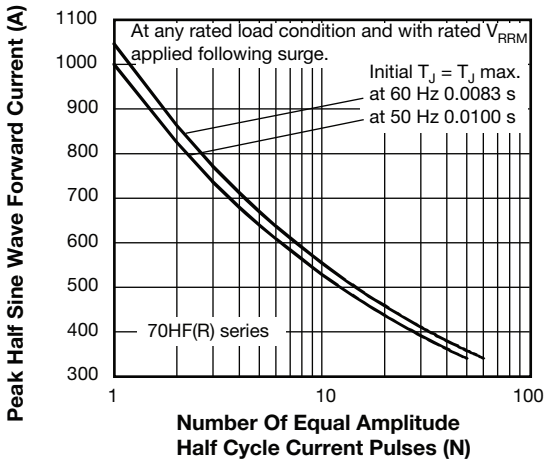

Fig. 9 - Maximum Non-Repetitive Surge Current

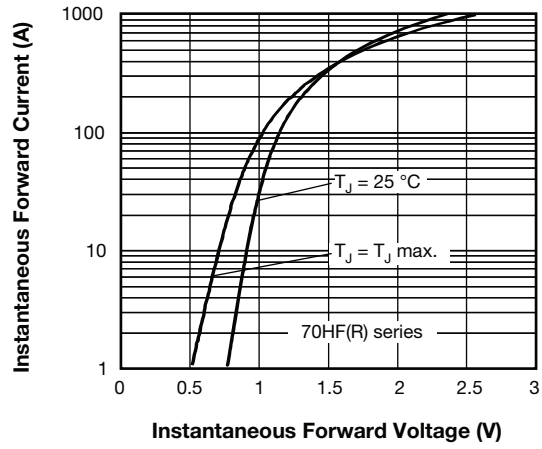

Fig. 11 - Forward Voltage Drop Characteristics

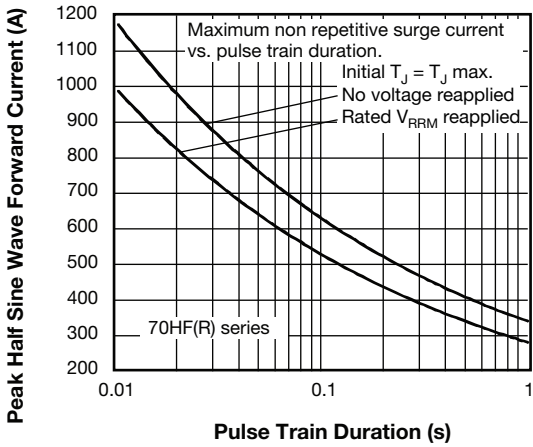

Fig. 10 - Maximum Non-Repetitive Surge Current

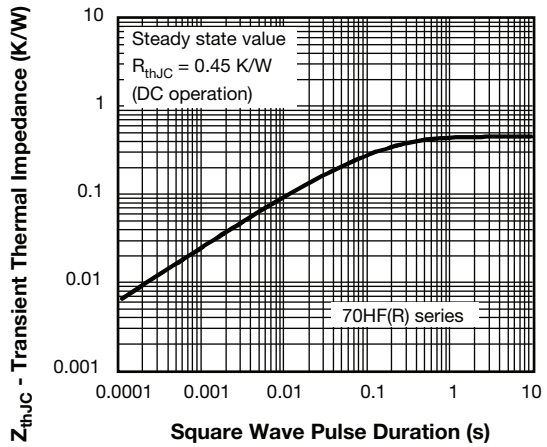

Fig. 12 - Thermal Impedance Z_{thJC} Characteristics

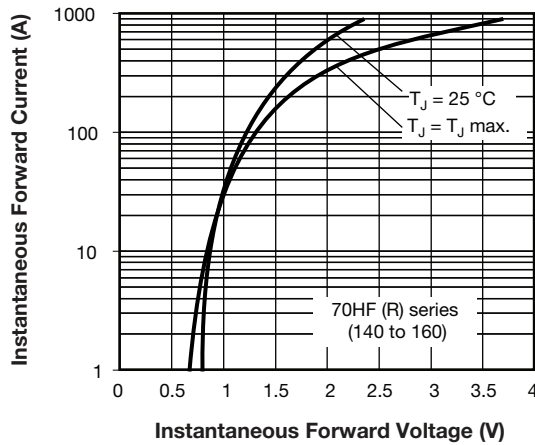
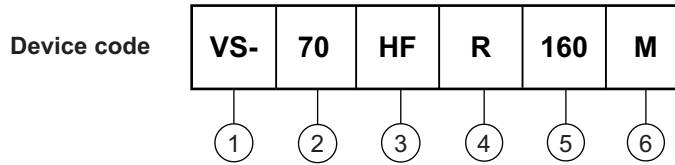

Fig. 13 - Forward Voltage Drop Characteristics



ORDERING INFORMATION TABLE



- 1** - Vishay Semiconductors product
- 2** - 70 = standard device
71 = not isolated lead
72 = isolated lead with silicone sleeve
(red = reverse polarity)
(blue = normal polarity)
- 3** - HF = standard diode
- 4** -
 - None = stud normal polarity (cathode to stud)
 - R = stud reverse polarity (anode to stud)
- 5** - Voltage code x 10 = V_{RRM} (see Voltage Ratings table)
- 6** -
 - None = stud base DO-5 (DO-203AB) 1/4" 28UNF-2A
 - M = stud base DO-5 (DO-203AB) M6 x 1

LINKS TO RELATED DOCUMENTS	
Dimensions	www.vishay.com/doc?95343

DO-203AB (DO-5) for 70HF(R) and 71HF(R) Series

DIMENSIONS FOR 70HF(R) SERIES in millimeters (inches)

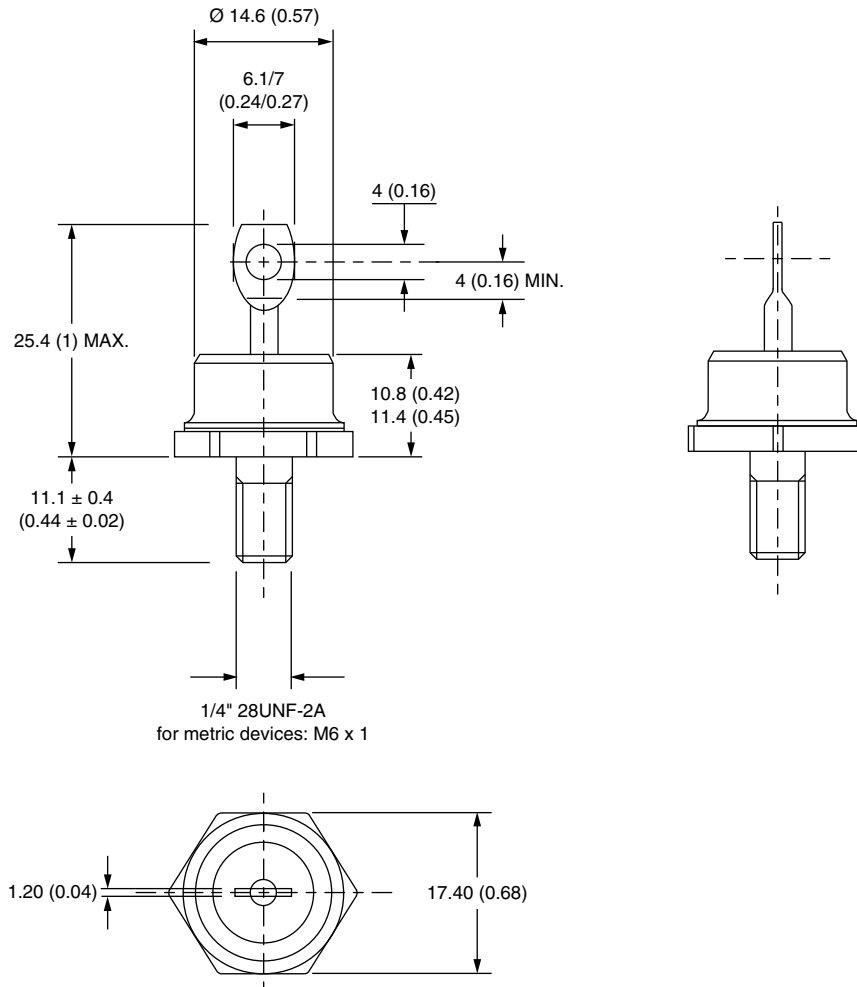

Outline Dimensions

Vishay Semiconductors

DO-203AB (DO-5) for 70HF(R)
and 71HF(R) Series



DIMENSIONS FOR 71HF(R) SERIES in millimeters (inches)

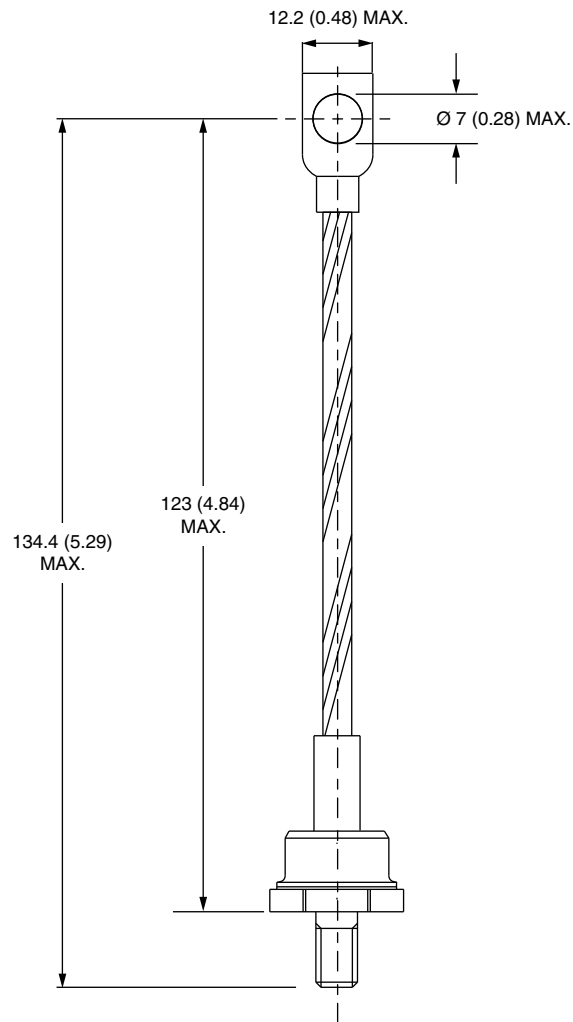



Disclaimer

ALL PRODUCT, PRODUCT SPECIFICATIONS AND DATA ARE SUBJECT TO CHANGE WITHOUT NOTICE TO IMPROVE RELIABILITY, FUNCTION OR DESIGN OR OTHERWISE.

Vishay Intertechnology, Inc., its affiliates, agents, and employees, and all persons acting on its or their behalf (collectively, "Vishay"), disclaim any and all liability for any errors, inaccuracies or incompleteness contained in any datasheet or in any other disclosure relating to any product.

Vishay makes no warranty, representation or guarantee regarding the suitability of the products for any particular purpose or the continuing production of any product. To the maximum extent permitted by applicable law, Vishay disclaims (i) any and all liability arising out of the application or use of any product, (ii) any and all liability, including without limitation special, consequential or incidental damages, and (iii) any and all implied warranties, including warranties of fitness for particular purpose, non-infringement and merchantability.

Statements regarding the suitability of products for certain types of applications are based on Vishay's knowledge of typical requirements that are often placed on Vishay products in generic applications. Such statements are not binding statements about the suitability of products for a particular application. It is the customer's responsibility to validate that a particular product with the properties described in the product specification is suitable for use in a particular application. Parameters provided in datasheets and / or specifications may vary in different applications and performance may vary over time. All operating parameters, including typical parameters, must be validated for each customer application by the customer's technical experts. Product specifications do not expand or otherwise modify Vishay's terms and conditions of purchase, including but not limited to the warranty expressed therein.

Hyperlinks included in this datasheet may direct users to third-party websites. These links are provided as a convenience and for informational purposes only. Inclusion of these hyperlinks does not constitute an endorsement or an approval by Vishay of any of the products, services or opinions of the corporation, organization or individual associated with the third-party website. Vishay disclaims any and all liability and bears no responsibility for the accuracy, legality or content of the third-party website or for that of subsequent links.

Except as expressly indicated in writing, Vishay products are not designed for use in medical, life-saving, or life-sustaining applications or for any other application in which the failure of the Vishay product could result in personal injury or death. Customers using or selling Vishay products not expressly indicated for use in such applications do so at their own risk. Please contact authorized Vishay personnel to obtain written terms and conditions regarding products designed for such applications.

No license, express or implied, by estoppel or otherwise, to any intellectual property rights is granted by this document or by any conduct of Vishay. Product names and markings noted herein may be trademarks of their respective owners.

Looking for pricing, stock, or lifecycle information?

Click below to explore more details on WIN SOURCE:

 [View VS-70HF160 on WIN SOURCE](#)

 [Vishay Information](#)

Optimize Your Supply Chain with WIN SOURCE Solutions

-  Global Sourcing Solution
-  Obsolete Management
-  Cost Control Management
-  Shortage Management
-  Alternative Solution
-  Excess Inventory Management