



**NPN PRE-BIASED SMALL SIGNAL DUAL SURFACE MOUNT TRANSISTOR**
**Features**

- Epitaxial Planar Die Construction
- Complementary PNP Types Available (DDA)
- Built-In Biasing Resistors
- **Totally Lead-Free & Fully RoHS Compliant (Notes 1 & 2)**
- **Halogen and Antimony Free. "Green" Device (Note 3)**
- **Qualified to AEC-Q101 Standards for High Reliability**
- **PPAP Capable (Note 4)**

Part Number	R1 (NOM)	R2 (NOM)
DDC124EU	22kΩ	22kΩ
DDC144EU	47kΩ	47kΩ
DDC114YU	10kΩ	47kΩ
DDC123JU	2.2kΩ	47kΩ
DDC114EU	10kΩ	10kΩ
DDC143ZU	4.7kΩ	47kΩ
DDC115EU	100kΩ	100kΩ

**Mechanical Data**

- Case: SOT363
- Case Material: Molded Plastic, "Green" Molding Compound. UL Flammability Classification Rating 94V-0
- Moisture Sensitivity: Level 1 per J-STD-020
- Terminals: Finish – Matte Tin Plated Leads, Solderable per MIL-STD-202, Method 208
- Weight: 0.006 grams (Approximate)

Part Number	R1 Only
DDC113TU	1kΩ
DDC143TU	4.7kΩ
DDC114TU	10kΩ

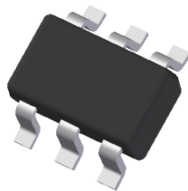
**SOT363**

Top View

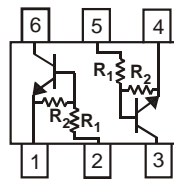

R1, R2

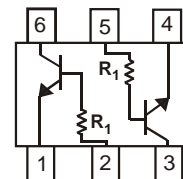

R1 Only

Device Schematic

**Ordering Information** (Notes 4, 5 & 6)

Product	Status	Compliance	Marking	Reel Size (inches)	Tape Width (mm)	Quantity per Reel
DDC124EU-7-F	Active	AEC-Q101	N17	7	8	3,000
DDC124EUQ-7-F	NRND (Use ADC124EUQ)	Automotive	N17	7	8	3,000
DDC144EU-7-F	Active	AEC-Q101	N20	7	8	3,000
DDC114YU-7-F	Active	AEC-Q101	N14	7	8	3,000
DDC114YUQ-7-F	NRND (Use ADC114YUQ)	Automotive	N14	7	8	3,000
DDC114YUQ-13-F	NRND (Use ADC114YUQ)	Automotive	N14	13	8	10,000
DDC123JU-7-F	Active	AEC-Q101	N06	7	8	3,000
DDC114EU-7-F	Active	AEC-Q101	N13	7	8	3,000
DDC114EUQ-7-F	NRND (Use ADC114EUQ)	Automotive	N13	7	8	3,000
DDC114EUQ-13-F	NRND (Use ADC114EUQ)	Automotive	N13	13	8	10,000
DDC113TU-7-F	Active	AEC-Q101	N01	7	8	3,000
DDC143TU-7-F	Active	AEC-Q101	N07	7	8	3,000
DDC114TU-7-F	Active	AEC-Q101	N12	7	8	3,000
DDC114TUQ-7-F	Active	Automotive	N12	7	8	3,000
DDC143ZU-7-F	Active	AEC-Q101	N03	7	8	3,000
DDC115EU-7-F	Active	AEC-Q101	N02	7	8	3,000

- Notes:
1. No purposely added lead. Fully EU Directive 2002/95/EC (RoHS), 2011/65/EU (RoHS 2) & 2015/863/EU (RoHS 3) compliant.
  2. See <https://www.diodes.com/quality/lead-free/> for more information about Diodes Incorporated's definitions of Halogen- and Antimony-free, "Green" and Lead-free.
  3. Halogen- and Antimony-free "Green" products are defined as those which contain <900ppm bromine, <900ppm chlorine (<1500ppm total Br + Cl) and <1000ppm antimony compounds.
  4. Automotive products are AEC-Q101 qualified and are PPAP capable. Automotive, AEC-Q101 and standard products are electrically and thermally the same, except where specified. For more information, please refer to <http://www.diodes.com/quality/>.
  5. For packaging details, go to our website at <https://www.diodes.com/design/support/packaging/diodes-packaging/>.
  6. NRND = Not Recommended for New Design.

## Marking Information

SOT363

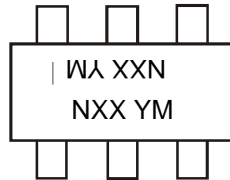

NXX = Product Type Marking Code (See Ordering Information)  
 YM = Date Code Marking  
 Y = Year (ex: F = 2018)  
 M = Month (ex: 9 = September)

Date Code Key

Year	2018	2019	2020	2021	2022	2023	2024	2025	2026	2027	2028
Code	F	G	H	I	J	K	L	M	N	O	P

Month	Jan	Feb	Mar	Apr	May	Jun	Jul	Aug	Sep	Oct	Nov	Dec
Code	1	2	3	4	5	6	7	8	9	O	N	D

## Absolute Maximum Ratings (@T<sub>A</sub> = +25°C, unless otherwise specified.)

Characteristic		Symbol	Value	Unit
Supply Voltage, <Pin: (6) to (1) and (3) to (4)>		V <sub>CC</sub>	50	V
Input Voltage, <Pin: (2) to (1) and (5) to (4)>	DDC124EU	V <sub>IN</sub>	-10 to +40	V
	DDC144EU		-10 to +40	
	DDC114YU		-6 to +40	
	DDC123JU		-5 to +12	
	DDC114EU		-10 to +40	
	DDC113TU		-5V max	
	DDC143TU		-5V max	
	DDC114TU		-5V max	
	DDC143ZU		-5 to +30	
	DDC115EU		-10 to +40	
Output Current	DDC124EU	I <sub>O</sub>	30	mA
	DDC144EU		30	
	DDC114YU		70	
	DDC123JU		100	
	DDC114EU		50	
	DDC113TU		100	
	DDC143TU		100	
	DDC114TU		100	
	DDC143ZU		100	
DDC115EU	20			
Output Current		I <sub>C(MAX)</sub>	100	mA

## Thermal Characteristics (@T<sub>A</sub> = +25°C, unless otherwise specified.)

Characteristic	Symbol	Value	Unit
Power Dissipation (Notes 7 & 8)	P <sub>D</sub>	200	mW
Thermal Resistance, Junction to Ambient Air (Note 7)	R <sub>θJA</sub>	625	°C/W
Operating and Storage Temperature Range	T <sub>J</sub> , T <sub>STG</sub>	-55 to +150	°C

Notes: 7. Mounted on FR-4 PC Board with minimum recommended pad layout.  
 8. 150mW per element must not be exceeded.

**Electrical Characteristics** (@T<sub>A</sub> = +25°C, unless otherwise specified.)

For R1 only Devices: DDC113TU & DDC143TU & DDC114TU

Characteristic	Symbol	Min	Typ	Max	Unit	Test Condition
Collector-Base Breakdown Voltage	BV <sub>CBO</sub>	50	—	—	V	I <sub>C</sub> = 50μA
Collector-Emitter Breakdown Voltage	BV <sub>CEO</sub>	50	—	—	V	I <sub>C</sub> = 1mA
Emitter-Base Breakdown Voltage	BV <sub>EBO</sub>	5	—	—	V	I <sub>E</sub> = 50μA
Collector Cutoff Current	I <sub>CBO</sub>	—	—	0.5	μA	V <sub>CB</sub> = 50V
Emitter Cutoff Current	I <sub>EBO</sub>	—	—	0.5	μA	V <sub>EB</sub> = 4V
Collector-Emitter Saturation Voltage	V <sub>CE(SAT)</sub>	—	—	0.3	V	I <sub>C</sub> /I <sub>B</sub> = 2.5mA / 0.25mA DDC143TU I <sub>C</sub> /I <sub>B</sub> = 1mA / 0.1mA DDC114TU I <sub>C</sub> /I <sub>B</sub> = 10mA / 1mA DDC113TU
DC Current Transfer Ratio	h <sub>FE</sub>	100	250	600	—	I <sub>C</sub> = 1mA, V <sub>CE</sub> = 5V
Input Resistor (R <sub>1</sub> ) Tolerance	ΔR <sub>1</sub>	-30	—	+30	%	—
Gain-Bandwidth Product (Note 9)	f <sub>T</sub>	—	250	—	MHz	V <sub>CE</sub> = 10V, I <sub>E</sub> = -5mA, f = 100MHz

**Electrical Characteristics** (@T<sub>A</sub> = +25°C, unless otherwise specified.)

For R1, R2 Devices: DDC124EU& DDC144EU& DDC114YU& DDC123JU& DDC114EU& DDC143ZU& DDC115EU

Characteristic	Symbol	Min	Typ	Max	Unit	Test Condition
Input Voltage	DDC124EU DDC144EU DDC114YU DDC123JU DDC114EU DDC143ZU DDC115EU	0.5 0.5 0.3 0.5 0.5 0.5 0.5	1.1 1.1 — — 1.1 — —	—	V	V <sub>CC</sub> = 5V, I <sub>O</sub> = 100μA
	DDC124EU DDC144EU DDC114YU DDC123JU DDC114EU DDC143ZU DDC115EU	— — — — — — —	1.9 1.9 — 1.1 1.9 — —	3.0 3.0 1.4 1.1 3.0 1.3 3		
Output Voltage	DDC124EU DDC144EU DDC114YU DDC123JU DDC114EU DDC143ZU DDC115EU	—	0.1	0.3	V	I <sub>O</sub> /I <sub>L</sub> = 10mA / 0.5mA I <sub>O</sub> /I <sub>L</sub> = 10mA / 0.5mA I <sub>O</sub> /I <sub>L</sub> = 5mA / 0.25mA I <sub>O</sub> /I <sub>L</sub> = 5mA / 0.25mA I <sub>O</sub> /I <sub>L</sub> = 10mA / 0.5mA I <sub>O</sub> /I <sub>L</sub> = 5mA / 0.25mA I <sub>O</sub> /I <sub>L</sub> = 10mA / 0.5mA
Input Current	DDC124EU DDC144EU DDC114YU DDC123JU DDC114EU DDC143ZU DDC115EU	—	—	0.36 0.18 0.88 3.6 0.88 1.8 0.15	mA	V <sub>I</sub> = 5V
Output Current	I <sub>O(OFF)</sub>	—	—	0.5	μA	V <sub>CC</sub> = 50V, V <sub>I</sub> = 0V
DC Current Gain	DDC124EU DDC144EU DDC114YU DDC114YUQ DDC123JU DDC114EU DDC143ZU DDC115EU	56 68 68 80 80 30 80 82	—	—	—	V <sub>O</sub> = 5V, I <sub>O</sub> = 5mA V <sub>O</sub> = 5V, I <sub>O</sub> = 5mA V <sub>O</sub> = 5V, I <sub>O</sub> = 10mA V <sub>O</sub> = 5V, I <sub>O</sub> = 5mA V <sub>O</sub> = 5V, I <sub>O</sub> = 10mA V <sub>O</sub> = 5V, I <sub>O</sub> = 5mA V <sub>O</sub> = 5V, I <sub>O</sub> = 10mA V <sub>O</sub> = 5V, I <sub>O</sub> = 5mA
Input Resistor (R <sub>1</sub> ) Tolerance	ΔR <sub>1</sub>	-30	—	+30	%	—
Resistance Ratio Tolerance	Δ(R <sub>2</sub> /R <sub>1</sub> )	-20	—	+20	%	—
Gain-Bandwidth Product (Note 9)	f <sub>T</sub>	—	250	—	MHz	V <sub>CE</sub> = 10V, I <sub>E</sub> = 5mA, f = 100MHz

Note: 9. Transistor - For Reference Only.

**Typical Curves – DDC123JU** (@T<sub>A</sub> = +25°C, unless otherwise specified.)

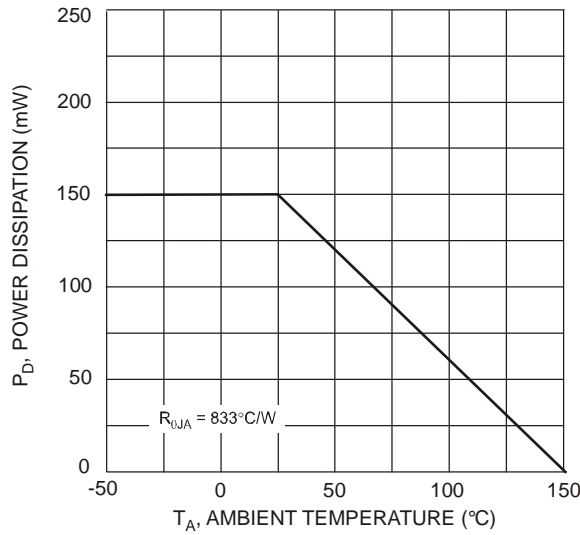

Fig. 1 Derating Curve

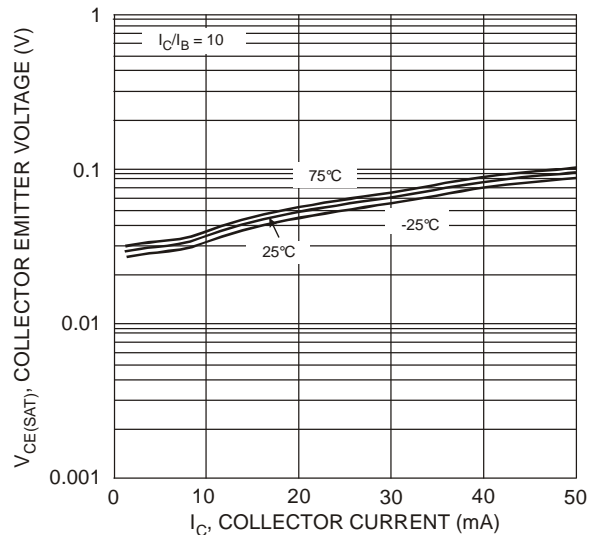

Fig. 2 V<sub>CE(SAT)</sub> vs. I<sub>C</sub>

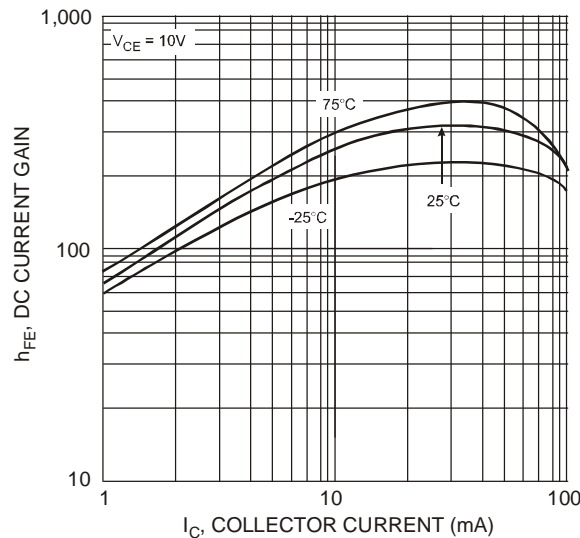

Fig. 3 DC Current Gain

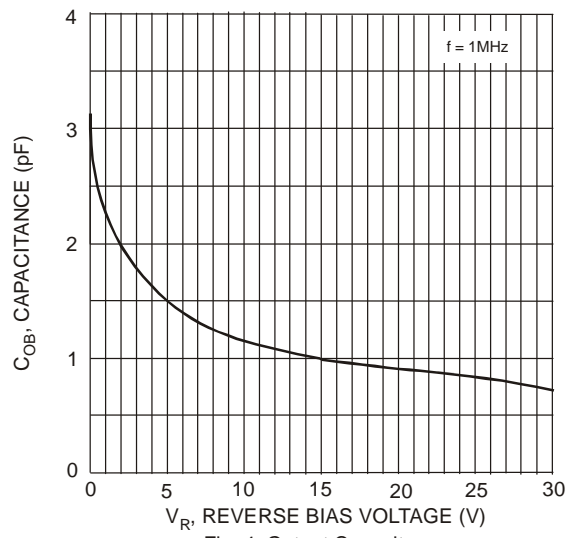

Fig. 4 Output Capacitance

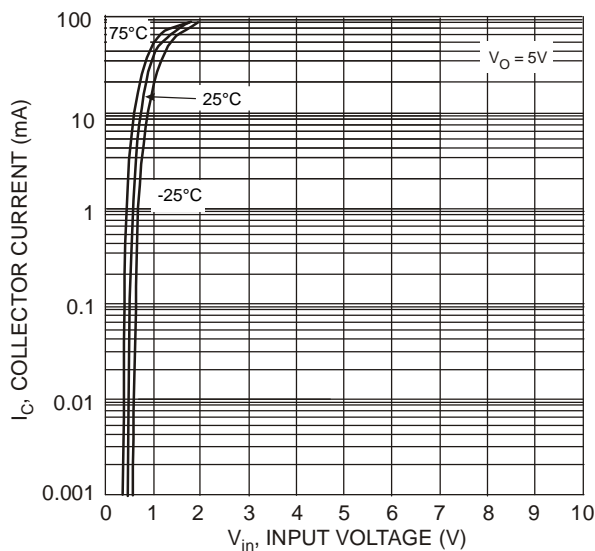

Fig. 5 Collector Current vs. Input Voltage

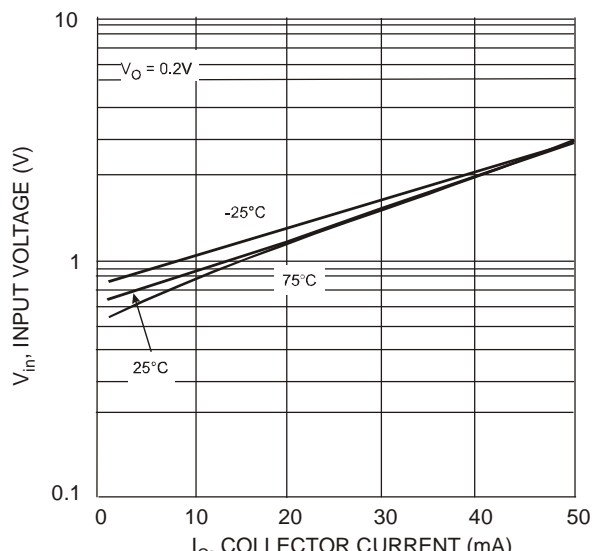
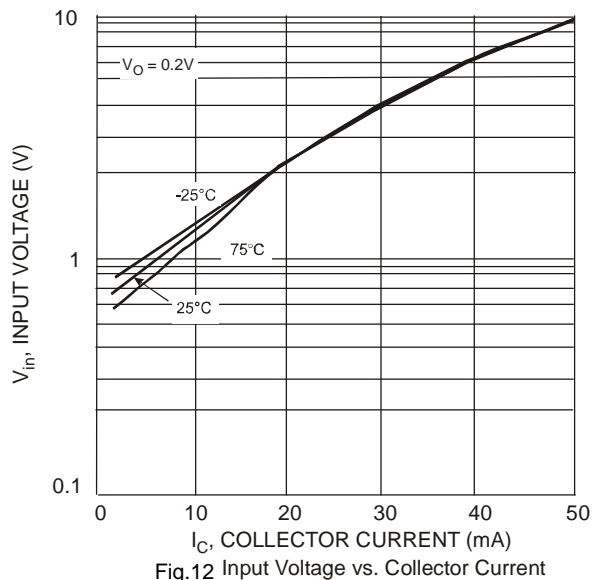
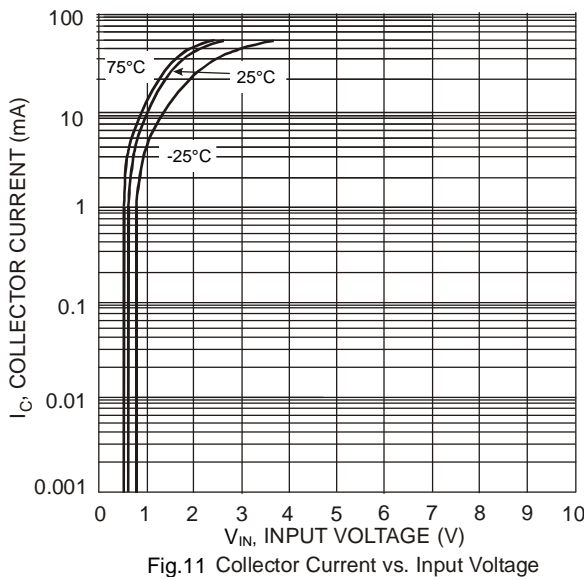
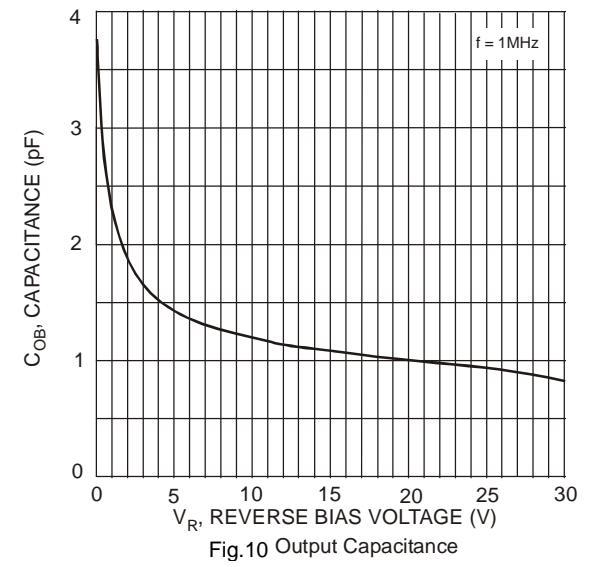
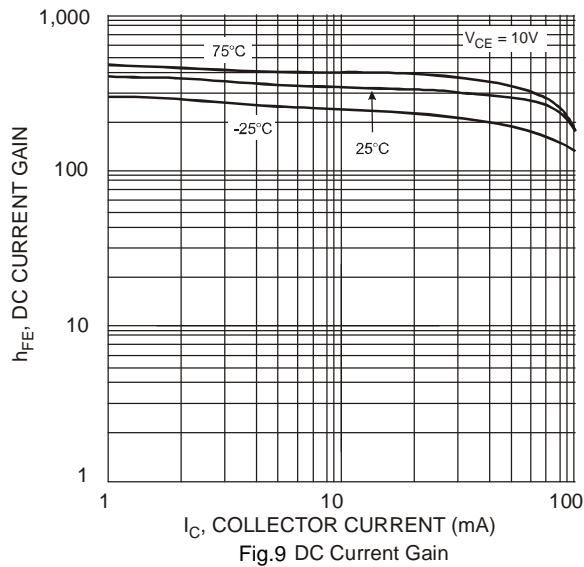
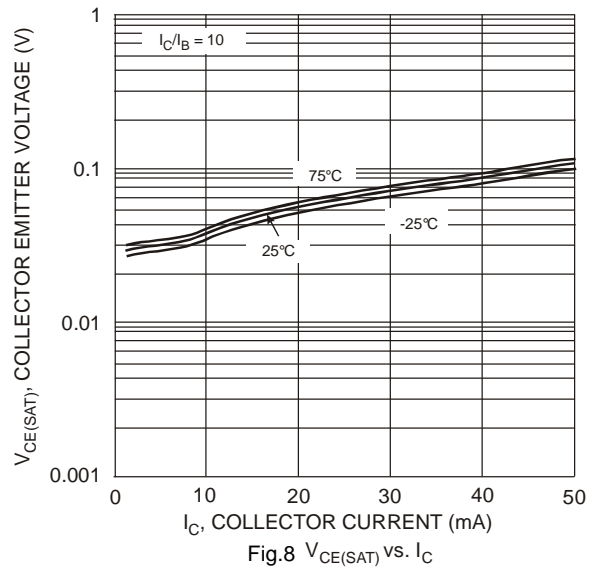
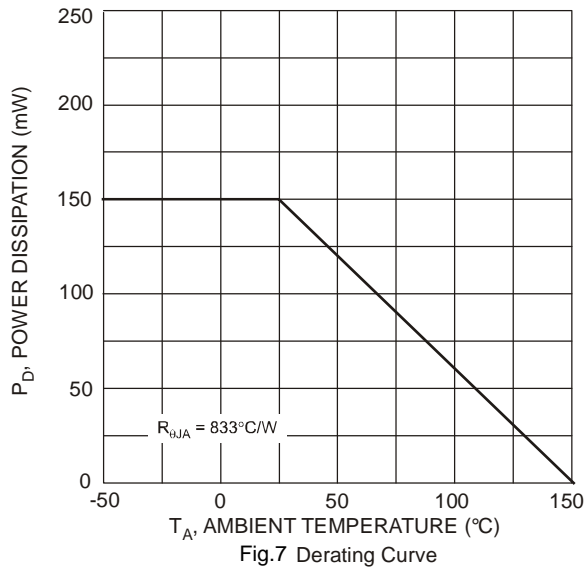

Fig. 6 Input Voltage vs. Collector Current

**Typical Curves – DDC114YU** (@ $T_A = +25^\circ\text{C}$ , unless otherwise specified.)



**Typical Curves – DDC124EU** (@ $T_A = +25^\circ\text{C}$ , unless otherwise specified.)

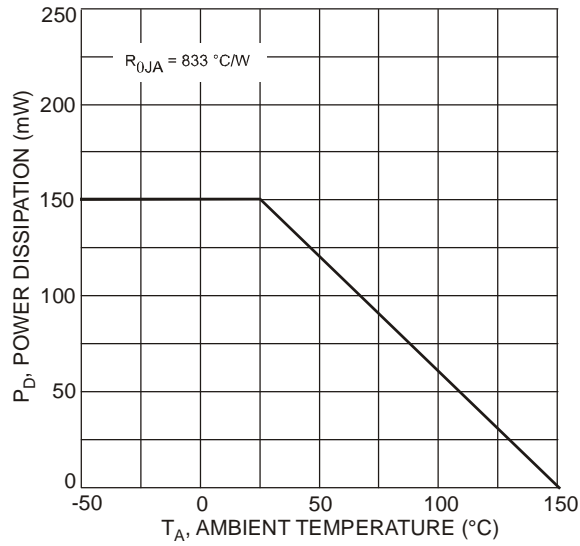

Fig.13 Power Dissipation vs. Ambient Temperature

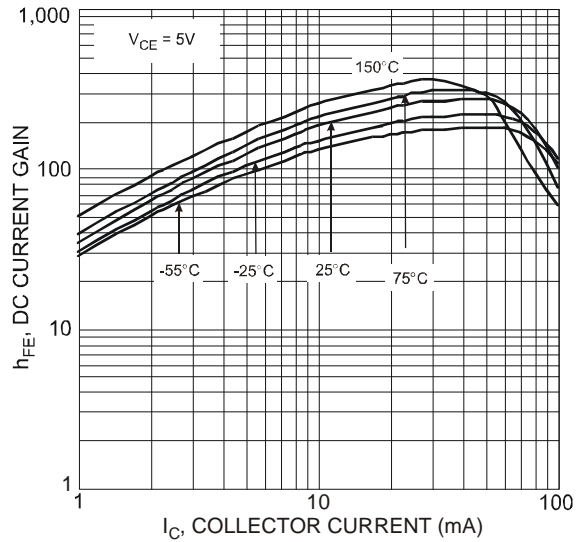

Fig.14 Typical DC Current Gain vs. Collector Current

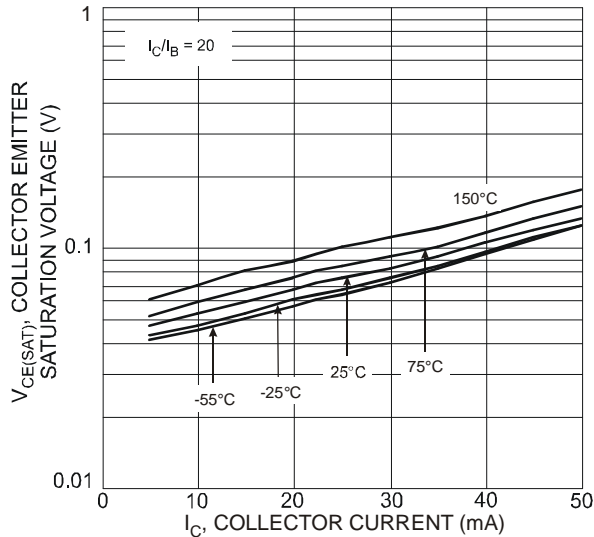

Fig.15 Collector Emitter Saturation Voltage vs. Collector Current

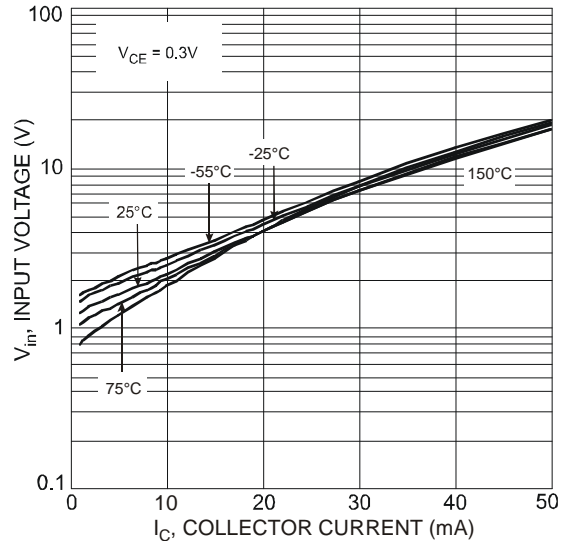
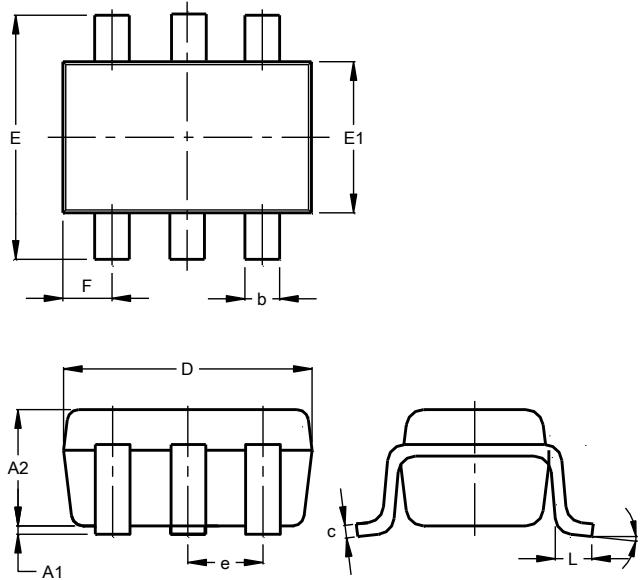

Fig.16 Input Voltage vs. Collector Current

**Package Outline Dimensions**

Please see <http://www.diodes.com/package-outlines.html> for the latest version.

**SOT363**



SOT363			
Dim	Min	Max	Typ
A1	0.00	0.10	0.05
A2	0.90	1.00	0.95
b	0.10	0.30	0.25
c	0.10	0.22	0.11
D	1.80	2.20	2.15
E	2.00	2.20	2.10
E1	1.15	1.35	1.30
e	0.650 BSC		
F	0.40	0.45	0.425
L	0.25	0.40	0.30
a	0°	8°	--
<b>All Dimensions in mm</b>			

**Suggested Pad Layout**

Please see <http://www.diodes.com/package-outlines.html> for the latest version.

**SOT363**

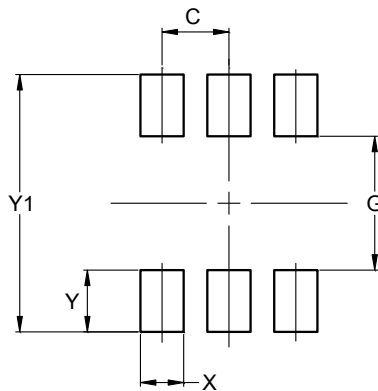

Dimensions	Value (in mm)
C	0.650
G	1.300
X	0.420
Y	0.600
Y1	2.500

**IMPORTANT NOTICE**

DIODES INCORPORATED MAKES NO WARRANTY OF ANY KIND, EXPRESS OR IMPLIED, WITH REGARDS TO THIS DOCUMENT, INCLUDING, BUT NOT LIMITED TO, THE IMPLIED WARRANTIES OF MERCHANTABILITY AND FITNESS FOR A PARTICULAR PURPOSE (AND THEIR EQUIVALENTS UNDER THE LAWS OF ANY JURISDICTION).

Diodes Incorporated and its subsidiaries reserve the right to make modifications, enhancements, improvements, corrections or other changes without further notice to this document and any product described herein. Diodes Incorporated does not assume any liability arising out of the application or use of this document or any product described herein; neither does Diodes Incorporated convey any license under its patent or trademark rights, nor the rights of others. Any Customer or user of this document or products described herein in such applications shall assume all risks of such use and will agree to hold Diodes Incorporated and all the companies whose products are represented on Diodes Incorporated website, harmless against all damages.

Diodes Incorporated does not warrant or accept any liability whatsoever in respect of any products purchased through unauthorized sales channel. Should Customers purchase or use Diodes Incorporated products for any unintended or unauthorized application, Customers shall indemnify and hold Diodes Incorporated and its representatives harmless against all claims, damages, expenses, and attorney fees arising out of, directly or indirectly, any claim of personal injury or death associated with such unintended or unauthorized application.

Products described herein may be covered by one or more United States, international or foreign patents pending. Product names and markings noted herein may also be covered by one or more United States, international or foreign trademarks.

This document is written in English but may be translated into multiple languages for reference. Only the English version of this document is the final and determinative format released by Diodes Incorporated.

**LIFE SUPPORT**

Diodes Incorporated products are specifically not authorized for use as critical components in life support devices or systems without the express written approval of the Chief Executive Officer of Diodes Incorporated. As used herein:

A. Life support devices or systems are devices or systems which:

1. are intended to implant into the body, or
2. support or sustain life and whose failure to perform when properly used in accordance with instructions for use provided in the labeling can be reasonably expected to result in significant injury to the user.

B. A critical component is any component in a life support device or system whose failure to perform can be reasonably expected to cause the failure of the life support device or to affect its safety or effectiveness.

Customers represent that they have all necessary expertise in the safety and regulatory ramifications of their life support devices or systems, and acknowledge and agree that they are solely responsible for all legal, regulatory and safety-related requirements concerning their products and any use of Diodes Incorporated products in such safety-critical, life support devices or systems, notwithstanding any devices- or systems-related information or support that may be provided by Diodes Incorporated. Further, Customers must fully indemnify Diodes Incorporated and its representatives against any damages arising out of the use of Diodes Incorporated products in such safety-critical, life support devices or systems.

Copyright © 2018, Diodes Incorporated

[www.diodes.com](http://www.diodes.com)

## Looking for pricing, stock, or lifecycle information?

Click below to explore more details on WIN SOURCE:

 [View DDC143TU-7-F on WIN SOURCE](#)

 [Diodes Incorporated](#) Information

## Optimize Your Supply Chain with WIN SOURCE Solutions

-  Global Sourcing Solution
-  Obsolete Management
-  Cost Control Management
-  Shortage Management
-  Alternative Solution
-  Excess Inventory Management