

MGV High Current Molded SMT Power Inductors MGV0605 Series

FEATURES AND APPLICATIONS

Laird MGV series high current power inductors improve performance, reliability and power efficiency. A lower profile benefits consumer electronics and telecom design. Products feature extremely low DCR with greater efficiency and enable a large current in a small size. Inductors are of magnetic shielding and molded construction and perform in operating temperatures ranging from -40 C to 125 C including self-heating rise in temperature.

FEATURES

- Magnetic shielded structure
- Low DCR and high efficiency
- Low profile and miniaturization
- High reliability

APPLICATIONS

- DC-DC Converter and Power Suppliers
- LCD TV'S and Gaming Console
- Tablet, Notebooks, Servers and Printers
- Networking and Data storage
- GPS, Set-top-box and Base stations
- Smart meters and Medical instruments



PART NUMBER EXPLANATION

MGV	0605	4R7	M	-	10
Product series code	Product size code	Inductance value code (i.e. 4R7: 4.7 μ H)	Tolerance % (i.e. M: \pm 20%)		Standard Catalog P.N

Note: Automotive grade parts are also available, a specific P.N will be assigned upon request.
Please contact laird local sales for details.

ELECTRICAL SPECIFICATIONS

- Tolerance: M: \pm 20% or N: \pm 30%
- Inductance tested at 100KHz, 1.0V
- Heat Rated Current (Irms) is defined based on temperature rise approximate 40°C without core loss (ambient temperature 25 \pm 5°C)
- Saturation Current (Isat) is the DC current at which the inductance drops off approximately 30% from its value without current. (ambient temperature 25 \pm 5°C)
- Operating temperature range: -40°C~+125°C (including self-heating temperature rise)
- Storage temperature range (packaging conditions): -10°C~+40°C and RH 60%(MAX.)

Note: Heat Rated Current (Irms) is tested on a typical PCB and apply a constant current in still air. The temperature rise is dependent on the application system condition including PCB PAD pattern, trace width and thickness and adjacent components etc. It's suggested to verify the temperature rise of the component under the real operation application conditions.

SPECIFICATION

1.MECHANICAL & DIMENSIONS

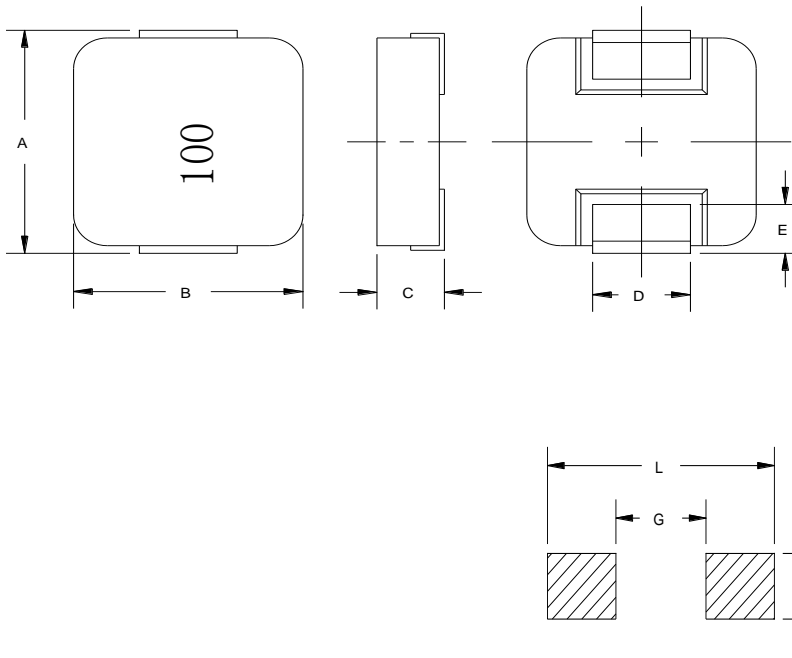

(UNIT: mm)	
A	7.30±0.50
B	6.70±0.40
C	5.00±0.40
D	3.00±0.30
E	1.80±0.50
L	8.40 ref
G	2.50 ref
H	3.50 ref
REMARK	

2.PART NUMBER NOMENCLATOR:

MGV 0605 100 M - 1X
A B C D E

A: Product Series.
 B: Series number, part size
 C: Inductance code

D: Inductance Tolerance. (M=±20% ,N=±30%)

E: "X"=0:Standard catalog part number

"X"=1-9:Controlled customized part **or** different performance than std catalog part. And "5-9" is for automotive grade.

3.EQUIVALENT CIRCUIT:

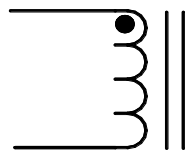

SPECIFICATION

PART NUMBER	INDUCTANCE (uH)±20%	I _{rms} (A) Typ.	I _{sat} (A) Typ.	DCR(mΩ) Typ	DCR(mΩ) Max	REMARK
MGV0605R22M-10	0.22	25.0	35.0	1.6	1.9	
MGV0605R56M-10	0.56	20.0	27.0	3.6	4.2	
MGV0605R68M-10	0.68	18.0	24.0	4.0	4.5	
MGV0605R82M-10	0.82	16.5	22.0	4.6	4.9	
MGV06051R0M-10	1.00	15.0	20.0	6.1	6.5	
MGV06051R5M-10	1.50	12.0	16.5	8.6	9.0	
MGV06052R2M-10	2.20	10.0	14.0	11.2	12.0	
MGV06053R3M-10	3.30	8.0	12.0	19.0	20.9	
MGV06054R7M-10	4.70	6.5	10.0	28.0	30.8	
MGV06055R6M-10	5.60	6.0	9.0	43.5	49.0	
MGV06056R8M-10	6.80	5.5	8.5	46.0	51.5	
MGV06058R2M-10	8.20	5.0	8.0	56.0	63.0	
MGV0605100M-10	10.0	4.0	7.5	60.0	69.0	
MGV0605150M-10	15.0	3.5	6.0	81.0	92.0	
MGV0605220M-10	22.0	2.5	5.5	140.0	170.0	
MGV0605470M-10	47.0	1.9	2.7	290.0	330.0	

GENERAL SPECIFICATION:

- Inductance tested at 100KHz, 0.25V
- Heat Rated Current (I_{rms}) is defined based on temperature rise approximate 40°C without core loss (ambient temperature 25±5°C)
- Saturation Current (I_{sat}) is the DC current at which the inductance drops off approximately 30% from its value without current. (ambient temperature 25±5°C)
- Operating temperature range: -40°C~+125°C (including self-heating temperature rise)
- Storage temperature range (packaging conditions): -10°C~+40°C and RH 60%(MAX.)

SPECIFICATION

Characteristics Curve

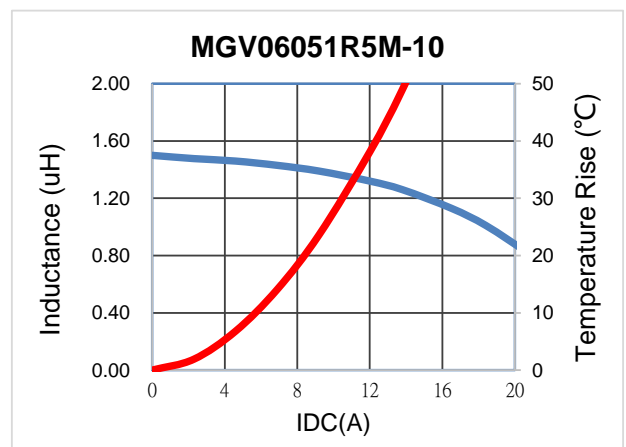
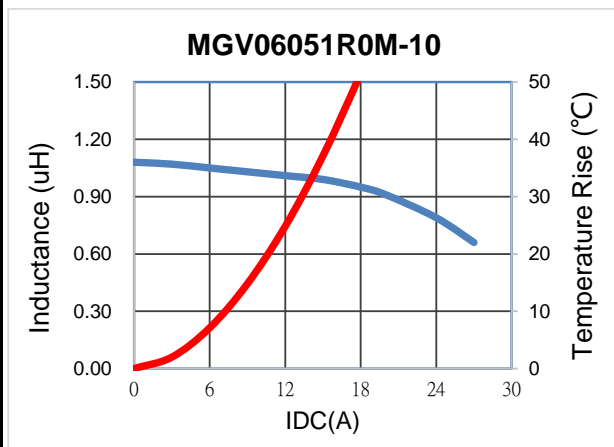
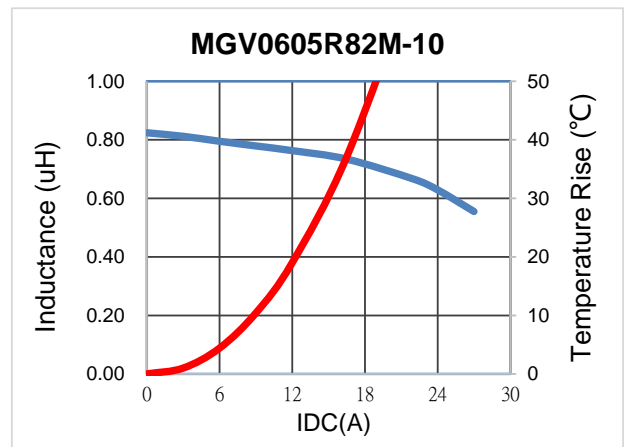
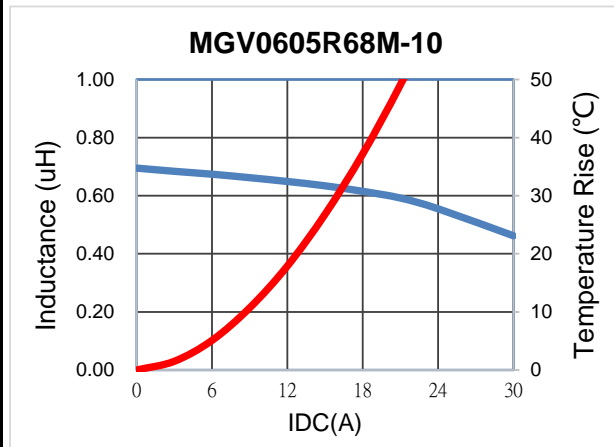
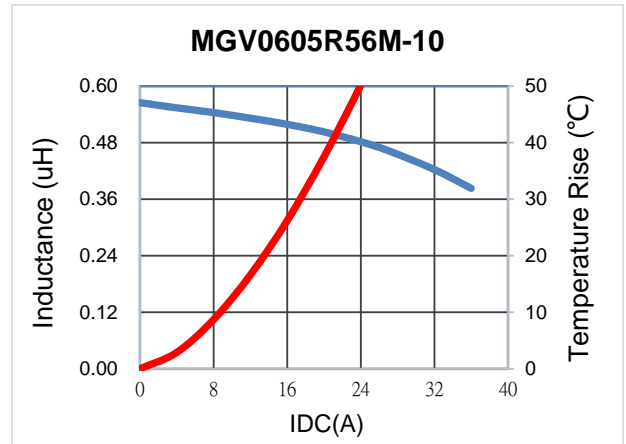
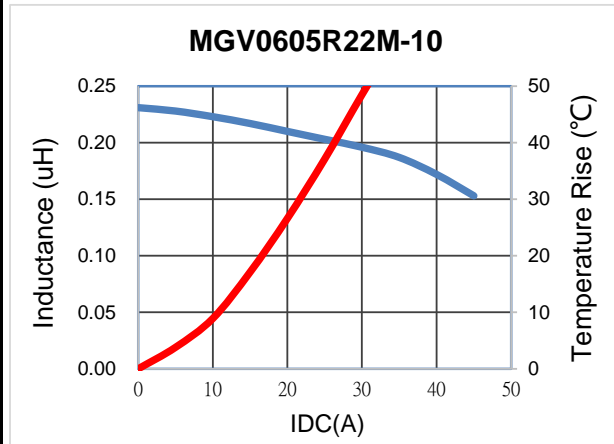

SPECIFICATION

Characteristics Curve

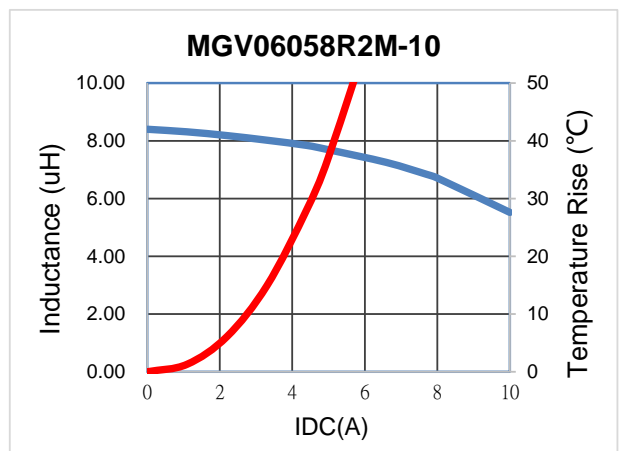
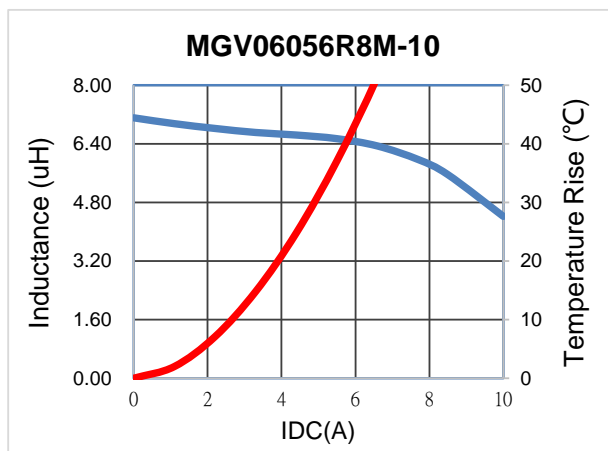
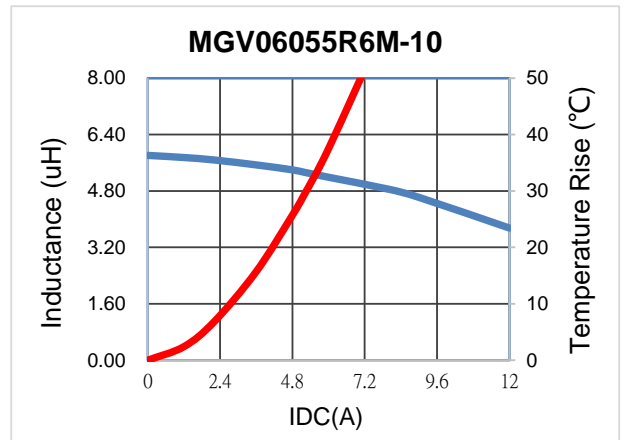
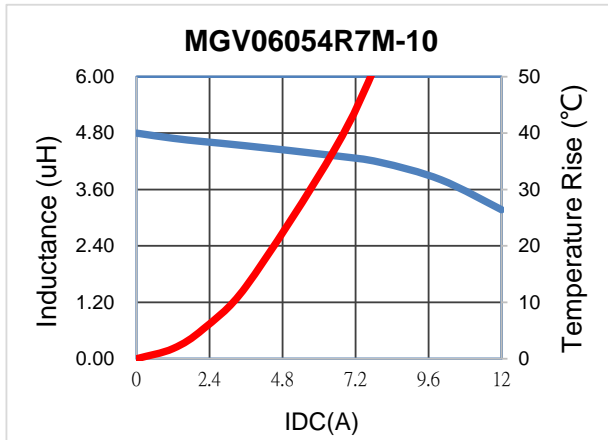
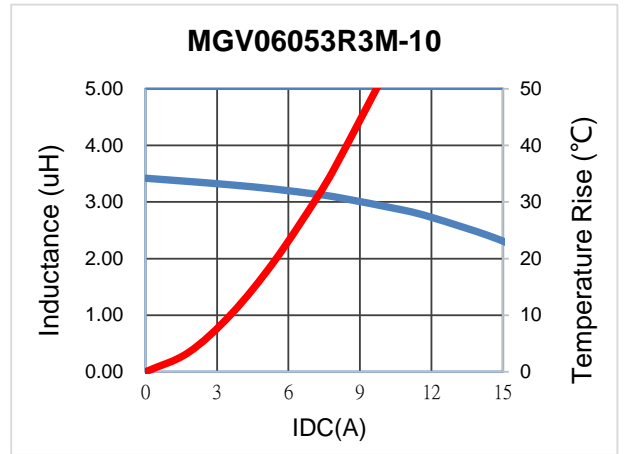
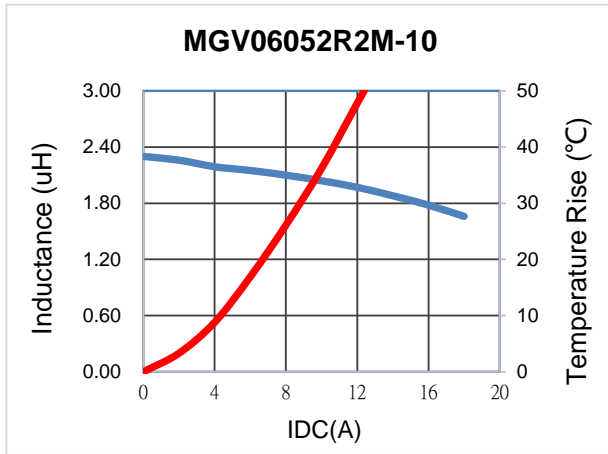

SPECIFICATION

Characteristics Curve

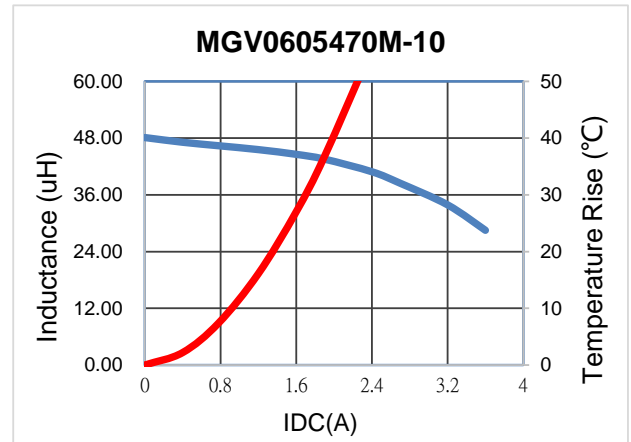
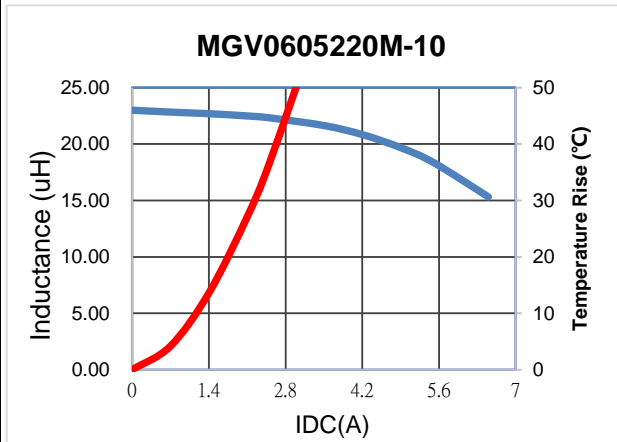
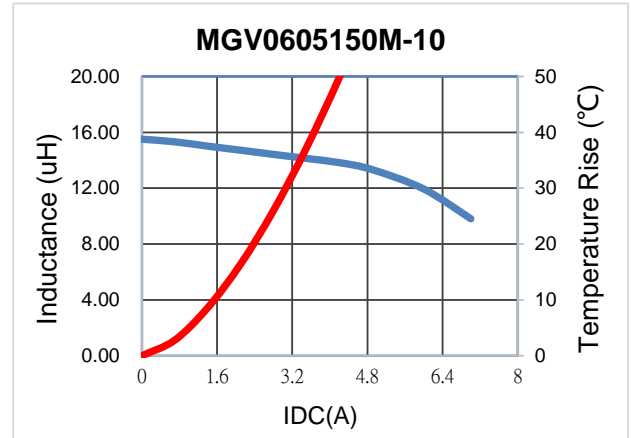
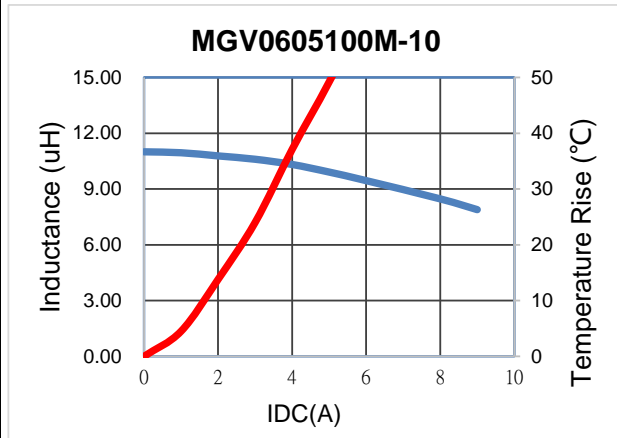

Recommended Soldering Conditions

For Lead-Free Application

Figure 1 . Re-flow Soldering

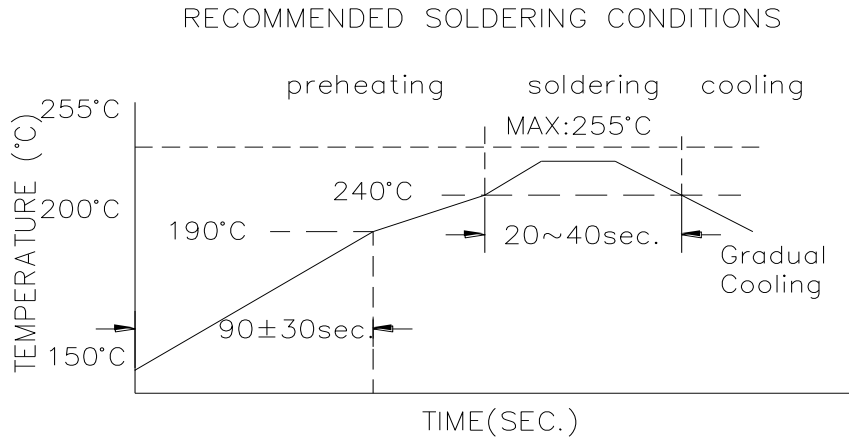

Reflow times: 3 times max

Figure 2 . Hand Soldering

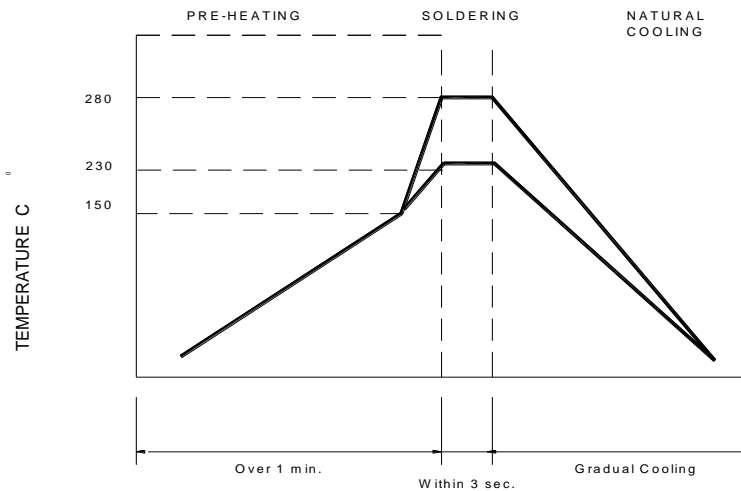

Hand solder times: 1 time max

Reliability and Testina Conditions / Pin Type Power Inductors		
SMD series(Consumer)		
Item	Reference	Additional Requirements
Operating temperature range	-55°C ~ +125°C (Including self-temperature rise)	
Storage temperature and humidity range	-10°C to +40°C , 60% RH Max	
High Temperature Exposure (Storage)	MIL-STD-202 Method 108	85±2°C, 168+24hours
Temperature Cycling	JESD22 Method JA-104	-40°C → +85, transforming interval:20s, 100cycles
Operational Life	MIL-PRF-2	85±2°C, 168+24hours Apply maximum rated voltage and current according part drawing
External Visual	MIL-STD-883 Method 2009	Inspect device construction, marking and workmanship. Electrical Test not required.
Physical Dimension	JESD22 Method JB-100	Verify physical dimensions to the applicable device detail specification. Note: User(s) and Suppliers spec. Electrical Test not required
Vibration	MIL-STD-202 Method 204	10~55Hz, 1.5mm, 2 hours in each 3 mutually perpendicular directions (total of 6 hours)
Resistance to Soldering Heat	MIL-STD-202 Method 210	1. Max. 260±5°C, 10±1s, 2 times 2. Solder Composition: Sn/3Ag/0.5Cu
Solderability	J-STD-002	245±5°C, 5±1sec, Solder: Sn/3.0Ag/0.5Cu
Electrical Characterization	Print Spec	Parametrically test per lot and sample size requirements, summary to show Min, Max, Mean and Standard deviation at room as well as Min and Max Operating temperatures
Board Flex	AEC-Q200-005	2mm, 30±1s
Terminal Strength(SMD)	AEC-Q200-006	10N, 5S, X,Y direct

PACKAGING

Reel Dimension

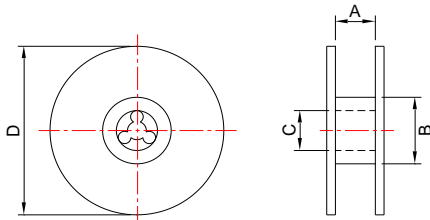

Type	A(mm)	B(mm)	C(mm)	D(mm)
13'x16	16.4+2/-0	100 ± 2	13+0.5/-0.2	330

Tape Dimension

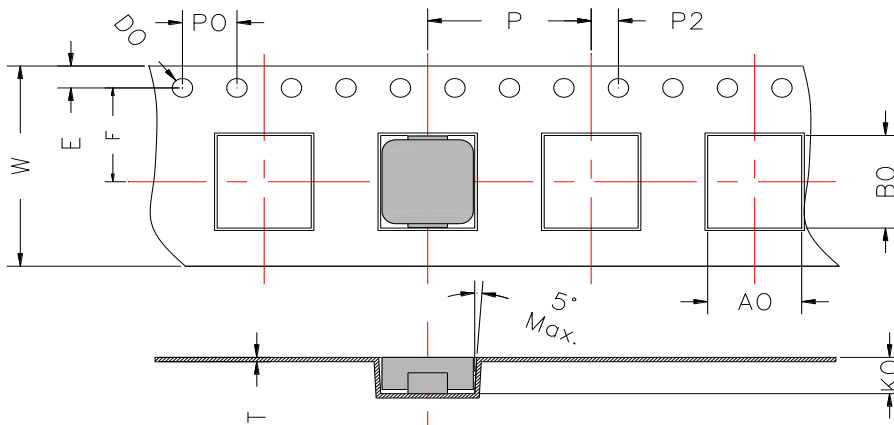

W	E	F	P	A0	B0	P2	P0	K0	t	D0
16.0±0.3	1.75±0.1	7.50±0.1	12.00±0.1	7.00±0.1	7.70±0.1	2.0±0.1	4.0±0.1	5.3±0.1	0.35±0.05	1.5Ref

Packaging Quantity

P/N	Chip/Reel	Inner Box	Outer Box
MGV0605	800pcs	1600pcs	3200pcs
Size	-	-	-

Peeling Off Force

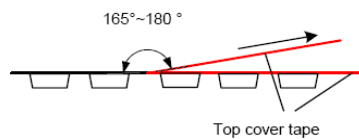

The force peeling off cover tape is 10 to 100 grams in the arrow direction under the following conditions			
Room Temp (°C)	Room Humidity	Room atrn (hPa)	Teaming Speed
5-35	45-85	860-1060	300

※Storage Conditions

1. Temperature and humidity conditions: -10-+40°C and 60% RH.
2. Recommended products should be used within 12 month from the time of manufacturing.
3. The packaging material should be kept where no chlorine or sulfur exists in the air.
4. Allowable stacking condition of Packaging box: max height 1.5m or 5 boxes stacking

Looking for pricing, stock, or lifecycle information?

Click below to explore more details on WIN SOURCE:

-  [View MGV06056R8M-10 on WIN SOURCE](#)
-  [Laird-Signal Integrity Products Information](#)

Optimize Your Supply Chain with WIN SOURCE Solutions

-  Global Sourcing Solution
-  Obsolete Management
-  Cost Control Management
-  Shortage Management
-  Alternative Solution
-  Excess Inventory Management