



**THE DATASHEET OF
DDTA125TE-7**



DDTA (R1-ONLY SERIES) E

PNP PRE-BIASED SMALL SIGNAL SURFACE MOUNT TRANSISTOR

NEW PRODUCT

Features

- Epitaxial Planar Die Construction
- Complementary NPN Types Available (DDTC)
- Built-In Biasing Resistor, R1 only
- Lead Free/RoHS Compliant (Note 2)
- "Green" Device (Note 3 and 4)

Mechanical Data

- Case: SOT-523
- Case Material: Molded Plastic. UL Flammability Classification Rating 94V-0
- Moisture Sensitivity: Level 1 per J-STD-020C
- Terminals: Solderable per MIL-STD-202, Method 208
- Lead Free Plating (Matte Tin Finish annealed over Alloy 42 leadframe).
- Terminal Connections: See Diagram
- Marking & Date Code Information: See Diagrams & Page 4
- Ordering Information: See Page 4
- Weight: 0.002 grams (approximate)

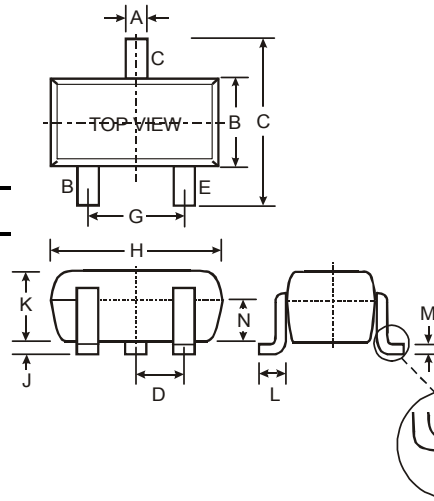

SOT-523			
Dim	Min	Max	Typ
A	0.15	0.30	0.22
B	0.75	0.85	0.80
C	1.45	1.75	1.60
D	—	—	0.50
G	0.90	1.10	1.00
H	1.50	1.70	1.60
J	0.00	0.10	0.05
K	0.60	0.80	0.75
L	0.10	0.30	0.22
M	0.10	0.20	0.12
N	0.45	0.65	0.50
α	0°	8°	—
All Dimensions in mm			

P/N	R1 (NOM)	MARKING
DDTA113TE	1K Ω	P01
DDTA123TE	2.2K Ω	P03
DDTA143TE	4.7K Ω	P07
DDTA114TE	10K Ω	P12
DDTA124TE	22K Ω	P16
DDTA144TE	47K Ω	P19
DDTA115TE	100K Ω	P23
DDTA125TE	200K Ω	P25

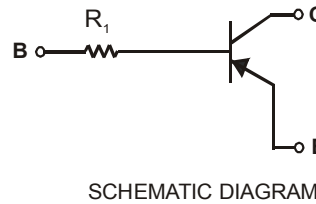

Maximum Ratings @_TA = 25°C unless otherwise specified

Characteristic	Symbol	Value	Unit
Collector-Base Voltage	V_{CBO}	-50	V
Collector-Emitter Voltage	V_{CEO}	-50	V
Emitter-Base Voltage	V_{EBO}	-5	V
Collector Current	I_C (Max)	-100	mA
Power Dissipation	P_d	150	mW
Thermal Resistance, Junction to Ambient Air (Note 1)	$R_{\theta JA}$	833	°C/W
Operating and Storage Temperature Range	T_j, T_{STG}	-55 to +150	°C

- Notes:
1. Mounted on FR4 PC Board with recommended pad layout as shown on Diodes Inc., suggested pad layout document AP02001, which can be found on our website at <http://www.diodes.com/datasheets/ap02001.pdf>
 2. No purposefully added lead.
 3. Diodes Inc.'s "Green" policy can be found on our website at http://www.diodes.com/products/lead_free/index.php.
 4. Product manufactured with Date Code UO (week 40, 2007) and newer are built with Green Molding Compound. Product manufactured prior to Date Code UO are built with Non-Green Molding Compound and may contain Halogens or Sb2O3 Fire Retardants.

Electrical Characteristics @T_A = 25°C unless otherwise specified

Characteristic	Symbol	Min	Typ	Max	Unit	Test Condition
Collector-Base Breakdown Voltage	BV _{CBO}	-50	—	—	V	I _C = -50μA
Collector-Emitter Breakdown Voltage	BV _{CEO}	-50	—	—	V	I _C = -1mA
Emitter-Base Breakdown Voltage	BV _{EBO}	-5	—	—	V	I _E = -50μA
Collector Cutoff Current	I _{CBO}	—	—	-0.5	μA	V _{CB} = -50V
Emitter Cutoff Current	I _{EBO}	—	—	-0.5	μA	V _{EB} = -4V
Collector-Emitter Saturation Voltage	V _{CE(sat)}	—	—	-0.3	V	I _C /I _B = -10mA/-1mA DDTA113TE I _C /I _B = -5mA/-0.5mA DDTA123TE I _C /I _B = -2.5mA/-0.25mA DDTA143TE I _C /I _B = -1mA/-0.1mA DDTA114TE I _C /I _B = -5mA/-0.5mA DDTA124TE I _C /I _B = -2.5mA/-0.25mA DDTA144TE I _C /I _B = -1mA/-0.1mA DDTA115TE I _C /I _B = -5mA/-0.5mA DDTA125TE
DC Current Transfer Ratio	h _{FE}	100	250	600	—	I _C = -1mA, V _{CE} = -5V
Gain-Bandwidth Product*	f _T	—	250	—	MHz	V _{CE} = -10V, I _E = 5mA, f = 100MHz

* Transistor - For Reference Only

Typical Curves – DDTA114TE

NEW PRODUCT

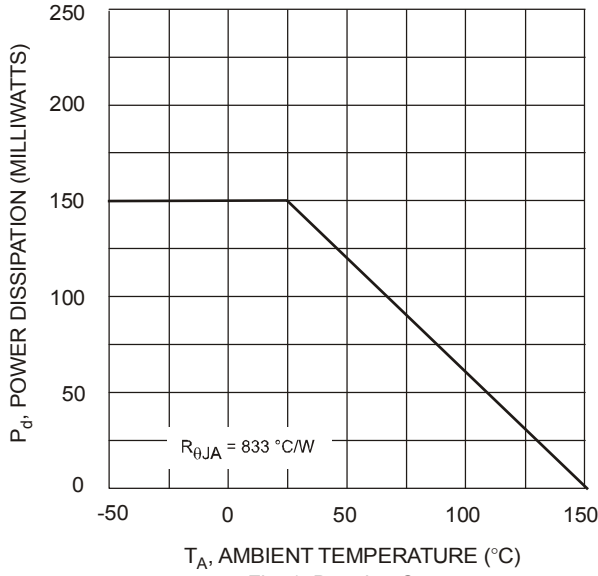

Fig. 1 Derating Curve

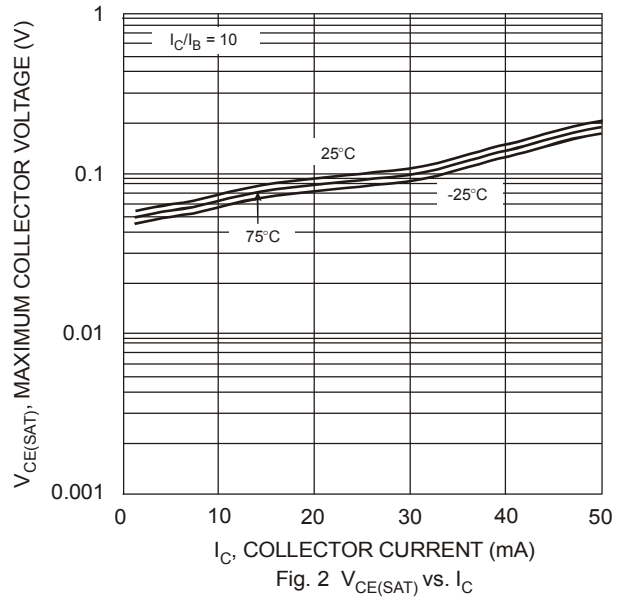

Fig. 2 $V_{CE(SAT)}$ vs. I_C

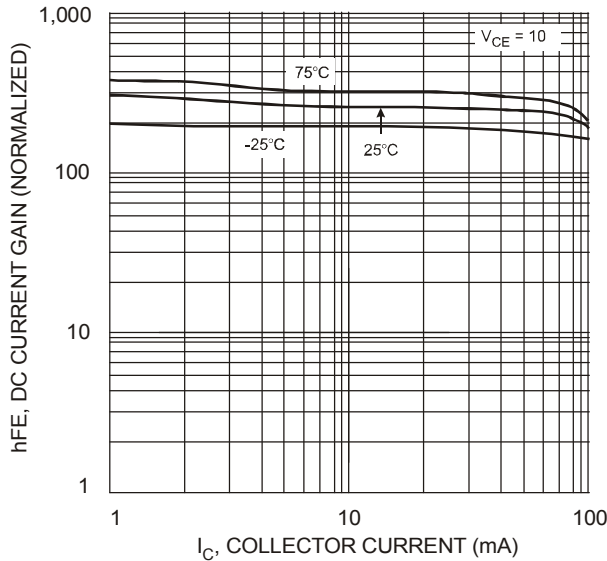

Fig. 3 DC Current Gain

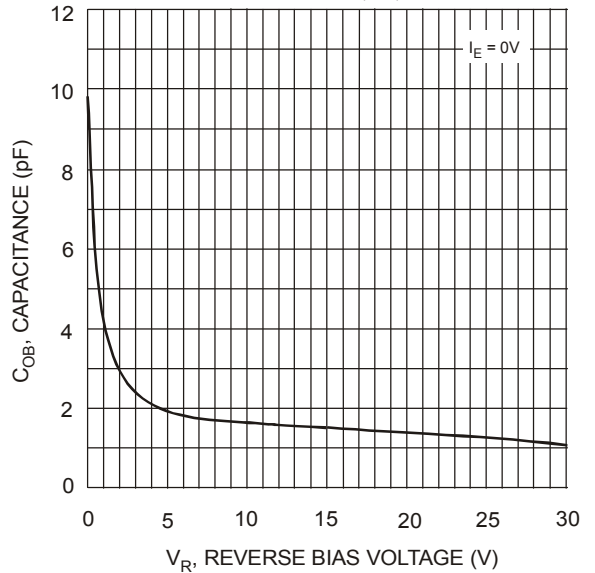

Fig. 4 Output Capacitance

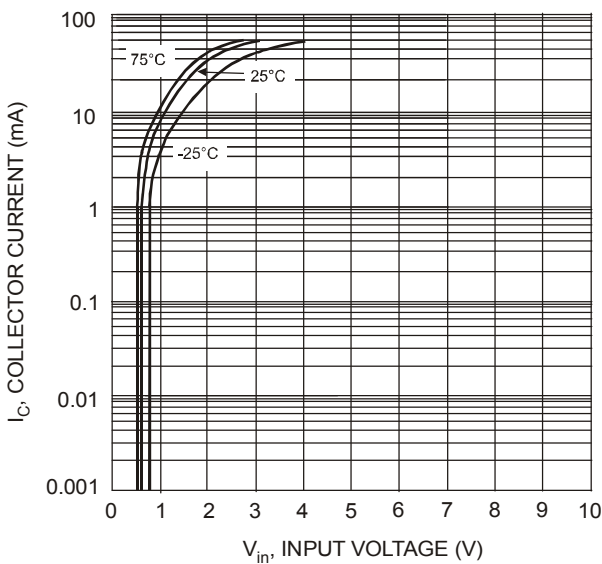

Fig. 5 Collector Current vs. Input Voltage

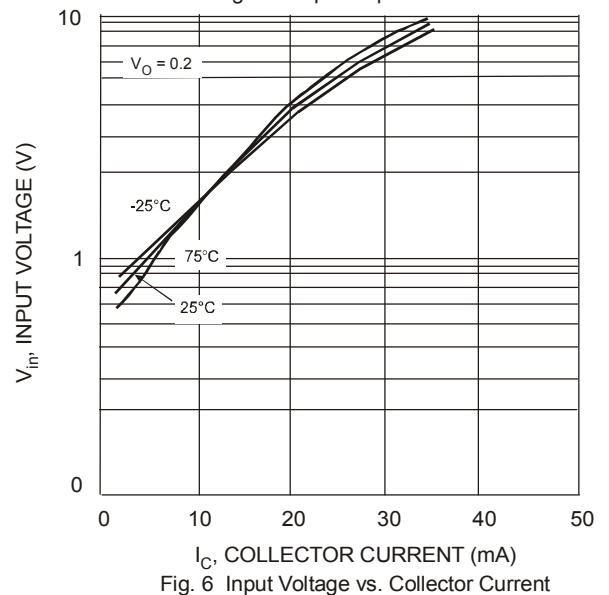

Fig. 6 Input Voltage vs. Collector Current

Ordering Information (Note 5)

Device	Packaging	Shipping
DDTA113TE-7-F	SOT-523	3000/Tape & Reel
DDTA123TE-7-F	SOT-523	3000/Tape & Reel
DDTA143TE-7-F	SOT-523	3000/Tape & Reel
DDTA114TE-7-F	SOT-523	3000/Tape & Reel
DDTA124TE-7-F	SOT-523	3000/Tape & Reel
DDTA144TE-7-F	SOT-523	3000/Tape & Reel
DDTA115TE-7-F	SOT-523	3000/Tape & Reel
DDTA125TE-7-F	SOT-523	3000/Tape & Reel

Notes: 5. For packaging details, go to our website at <http://www.diodes.com/datasheets/ap02007.pdf>.

Marking Information

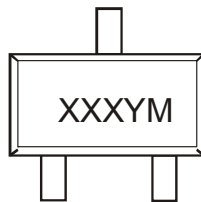

XXX = Product Type Marking Code (See Page 1, e.g. P01 = DDTA113TE)

YM = Date Code Marking

Y = Year ex: T = 2006

M = Month ex: 9 = September

Date Code Key

Year	2006	2007	2008	2009	2010	2011	2012
Code	T	U	V	W	X	Y	Z

Month	Jan	Feb	Mar	Apr	May	Jun	Jul	Aug	Sep	Oct	Nov	Dec
Code	1	2	3	4	5	6	7	8	9	O	N	D

IMPORTANT NOTICE

Diodes Incorporated and its subsidiaries reserve the right to make modifications, enhancements, improvements, corrections or other changes without further notice to any product herein. Diodes Incorporated does not assume any liability arising out of the application or use of any product described herein; neither does it convey any license under its patent rights, nor the rights of others. The user of products in such applications shall assume all risks of such use and will agree to hold Diodes Incorporated and all the companies whose products are represented on our website, harmless against all damages.

LIFE SUPPORT

Diodes Incorporated products are not authorized for use as critical components in life support devices or systems without the expressed written approval of the President of Diodes Incorporated.

Looking for pricing, stock, or lifecycle information?

Click below to explore more details on WIN SOURCE:

- ⊖ [View DDTA125TE-7 on WIN SOURCE](#)
- ⊖ [Diodes Incorporated Information](#)

Optimize Your Supply Chain with WIN SOURCE Solutions

- ✓ Global Sourcing Solution
- ✓ Obsolete Management
- ✓ Cost Control Management
- ✓ Shortage Management
- ✓ Alternative Solution
- ✓ Excess Inventory Management