



**THE DATASHEET OF
DDTB113EC-7-F**



NEW PRODUCT

Features

- Epitaxial Planar Die Construction
- Complementary NPN Types Available (DDTD)
- Built-In Biasing Resistors, R1, R2
- **Lead, Halogen and Antimony Free, RoHS Compliant "Green" Device (Notes 2 and 3)**

Mechanical Data

- Case: SOT-23
- Case Material: Molded Plastic. UL Flammability Classification Rating 94V-0
- Moisture Sensitivity: Level 1 per J-STD-020D
- Terminal Connections: See Diagram
- Terminals: Solderable per MIL-STD-202, Method 208
- Lead Free Plating (Matte Tin Finish annealed over Alloy 42 leadframe)
- Marking Information: See Table Below & Page 3
- Ordering Information: See Page 3
- Weight: 0.008 grams (approximate)

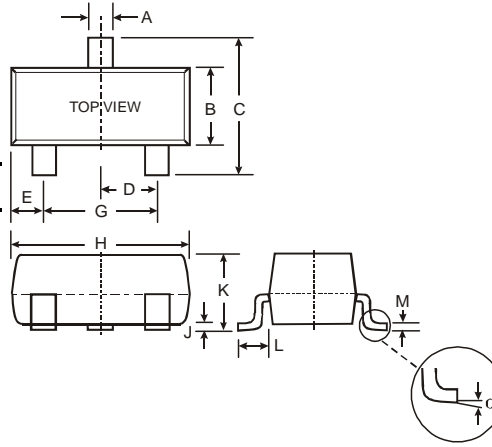

SOT-23		
Dim	Min	Max
A	0.37	0.51
B	1.20	1.40
C	2.30	2.50
D	0.89	1.03
E	0.45	0.60
G	1.78	2.05
H	2.80	3.00
J	0.013	0.10
K	0.903	1.10
L	0.45	0.61
M	0.085	0.180
α	0°	8°
All Dimensions in mm		

P/N	R1 (NOM)	R2 (NOM)	Type Code
DDTB113EC	1K	1K	P60
DDTB123EC	2.2K	2.2K	P61
DDTB143EC	4.7K	4.7K	P62
DDTB114EC	10K	10K	P63
DDTB122JC	0.22K	4.7K	P64
DDTB113ZC	1K	10K	P65
DDTB123YC	2.2K	10K	P66
DDTB133HC	3.3K	10K	P67
DDTB123TC	2.2K	OPEN	P69
DDTB143TC	4.7K	OPEN	P70
DDTB114TC	10K	OPEN	P71
DDTB114GC	0	10K	P72

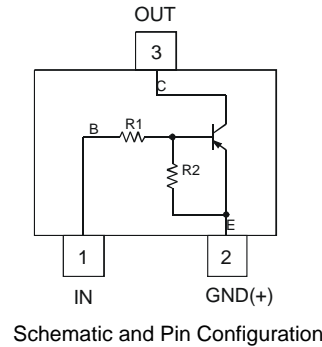

Maximum Ratings @T_A = 25°C unless otherwise specified

Characteristic	Symbol	Value	Unit
Supply Voltage, (3) to (2)	V _{CC}	-50	V
Input Voltage, (1) to (2)	V _{IN}	DDTB113EC: +10 to -10 DDTB123EC: +10 to -12 DDTB143EC: +10 to -30 DDTB114EC: +10 to -40 DDTB122JC: +5 to -5 DDTB113ZC: +5 to -10 DDTB123YC: +5 to -12 DDTB133HC: +6 to -20	V
Input Voltage, (1) to (2)	V _{EBO (MAX)}	-5	V
Output Current	I _C	-500	mA
Power Dissipation	P _D	200	mW
Thermal Resistance, Junction to Ambient Air (Note 1)	R _{θJA}	625	°C/W
Operating and Storage Temperature Range	T _J , T _{STG}	-55 to +150	°C

- Notes:
1. Mounted on FR4 PC Board with recommended pad layout at <http://www.diodes.com/datasheets/ap02001.pdf>.
 2. No purposefully added lead. Halogen and Antimony Free.
 3. Product manufactured with Data Code V9 (week 33, 2008) and newer are built with Green Molding Compound. Product manufactured prior to Date Code V9 are built with Non-Green Molding Compound and may contain Halogens or Sb₂O₃ Fire Retardants.

Electrical Characteristics @ $T_A = 25^\circ\text{C}$ unless otherwise specified **R1, R2 Types**

Characteristic		Symbol	Min	Typ	Max	Unit	Test Condition
Input Voltage	DDTB113EC DDTB123EC DDTB143EC DDTB114EC DDTB122JC DDTB113ZC DDTB123YC DDTB133HC	$V_{I(off)}$	-0.5 -0.5 -0.5 -0.5 -0.5 -0.3 -0.3 -0.3	—	—	V	$V_{CC} = -5V, I_O = -100\mu A$
	DDTB113EC DDTB123EC DDTB143EC DDTB114EC DDTB122JC DDTB113ZC DDTB123YC DDTB133HC	$V_{I(on)}$	—	—	-3.0 -3.0 -3.0 -3.0 -3.0 -2.0 -2.0 -2.0	V	$V_O = -0.3V, I_O = -20mA$ $V_O = -0.3V, I_O = -20mA$ $V_O = -0.3V, I_O = -20mA$ $V_O = -0.3V, I_O = -10mA$ $V_O = -0.3V, I_O = -30mA$ $V_O = -0.3V, I_O = -20mA$ $V_O = -0.3V, I_O = -20mA$ $V_O = -0.3V, I_O = -20mA$
Output Voltage		$V_{O(on)}$	—	—	-0.3V	V	$I_O/I_I = -50mA/-2.5mA$
Input Current	DDTB113EC DDTB123EC DDTB143EC DDTB114EC DDTB122JC DDTB113ZC DDTB123YC DDTB133HC	I_I	—	—	-7.2 -3.8 -1.8 -0.88 -28 -7.2 -3.6 -2.4	mA	$V_I = -5V$
Output Current		$I_{O(off)}$	—	—	-0.5	μA	$V_{CC} = -50V, V_I = 0V$
DC Current Gain	DDTB113EC DDTB123EC DDTB143EC DDTB114EC DDTB122JC DDTB113ZC DDTB123YC DDTB133HC	G_I	33 39 47 56 47 56 56 56	—	—	—	$V_O = -5V, I_O = -50mA$
Gain-Bandwidth Product*		f_T	—	200	—	MHz	$V_{CE} = -10V, I_E = -5mA, f = 100MHz$

* Transistor - For Reference Only

Electrical Characteristics @ $T_A = 25^\circ\text{C}$ unless otherwise specified **R1-Only, R2-Only Types**

Characteristic		Symbol	Min	Typ	Max	Unit	Test Condition
Collector-Base Breakdown Voltage		BV_{CBO}	-50	—	—	V	$I_C = -50\mu A$
Collector-Emitter Breakdown Voltage		BV_{CEO}	-40	—	—	V	$I_C = -1mA$
Emitter-Base Breakdown Voltage	DDTB123TC DDTB143TC DDTB114TC DDTB114GC	BV_{EBO}	-5	—	—	V	$I_E = -50\mu A$ $I_E = -50\mu A$ $I_E = -50\mu A$ $I_E = -720\mu A$
Collector Cutoff Current		I_{CBO}	—	—	-0.5	μA	$V_{CB} = -50V$
Emitter Cutoff Current	DDTB123TC DDTB143TC DDTB114TC DDTB114GC	I_{EBO}	— — — -300	—	-0.5 -0.5 -0.5 -580	μA	$V_{EB} = -4V$
Collector-Emitter Saturation Voltage		$V_{CE(sat)}$	—	—	-0.3	V	$I_C = -50mA, I_B = -2.5mA$
DC Current Transfer Ratio	DDTB123TC DDTB143TC DDTB114TC DDTB114GC	h_{FE}	100 100 100 56	250 250 250 —	600 600 600 —	—	$I_C = -5mA, V_{CE} = -5V$
Gain-Bandwidth Product*		f_T	—	200	—	MHz	$V_{CE} = -10V, I_E = 5mA, f = 100MHz$

* Transistor - For Reference Only

Ordering Information (Note 4)

Device	Packaging	Shipping
DDTB113EC-7-F	SOT-23	3000/Tape & Reel
DDTB123EC-7-F	SOT-23	3000/Tape & Reel
DDTB143EC-7-F	SOT-23	3000/Tape & Reel
DDTB114EC-7-F	SOT-23	3000/Tape & Reel
DDTB122JC-7-F	SOT-23	3000/Tape & Reel
DDTB113ZC-7-F	SOT-23	3000/Tape & Reel
DDTB123YC-7-F	SOT-23	3000/Tape & Reel
DDTB133HC-7-F	SOT-23	3000/Tape & Reel
DDTB123TC-7-F	SOT-23	3000/Tape & Reel
DDTB143TC-7-F	SOT-23	3000/Tape & Reel
DDTB114TC-7-F	SOT-23	3000/Tape & Reel
DDTB114GC-7-F	SOT-23	3000/Tape & Reel

Notes: 4. For packaging details, go to our website at <http://www.diodes.com/datasheets/ap02007.pdf>.

Marking Information

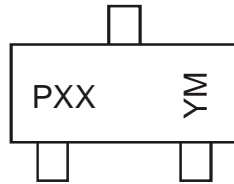

PXX = Product Type Marking Code, See Table on Page 1
 YM = Date Code Marking
 Y = Year ex: N = 2002
 M = Month ex: 9 = September

Date Code Key

Year	2002	2003	2004	2005	2006	2007	2008	2009	2010	2011	2012
Code	N	P	R	S	T	U	V	W	X	Y	Z

Month	Jan	Feb	Mar	Apr	May	Jun	Jul	Aug	Sep	Oct	Nov	Dec
Code	1	2	3	4	5	6	7	8	9	O	N	D

IMPORTANT NOTICE

Diodes Incorporated and its subsidiaries reserve the right to make modifications, enhancements, improvements, corrections or other changes without further notice to any product herein. Diodes Incorporated does not assume any liability arising out of the application or use of any product described herein; neither does it convey any license under its patent rights, nor the rights of others. The user of products in such applications shall assume all risks of such use and will agree to hold Diodes Incorporated and all the companies whose products are represented on our website, harmless against all damages.

LIFE SUPPORT

Diodes Incorporated products are not authorized for use as critical components in life support devices or systems without the expressed written approval of the President of Diodes Incorporated.

Looking for pricing, stock, or lifecycle information?

Click below to explore more details on WIN SOURCE:

-  [View DDTB113EC-7-F on WIN SOURCE](#)
-  [Diodes Incorporated Information](#)

Optimize Your Supply Chain with WIN SOURCE Solutions

-  Global Sourcing Solution
-  Obsolete Management
-  Cost Control Management
-  Shortage Management
-  Alternative Solution
-  Excess Inventory Management