



**THE DATASHEET OF
DDZ9694T-7**



Features

- Small, Low Profile Surface Mount Package
- Very Sharp Breakdown Characteristics
- Ideally Suited for Automated Assembly Processes
- Very Low Leakage Current
- **Totally Lead-Free & Fully RoHS Compliant (Notes 1 & 2)**
- **Halogen and Antimony Free. "Green" Device (Note 3)**

Mechanical Data

- Case: SOD523
- Case Material: Molded Plastic, "Green" Molding Compound. UL Flammability Classification Rating 94V-0
- Moisture Sensitivity: Level 1 per J-STD-020D
- Terminal Connections: Cathode Band
- Terminals: Finish - Matte Tin Annealed over Alloy 42 Leadframe. Solderable per MIL-STD-202, Method 208 ③
- Weight: 0.002 grams (Approximate)



Top View

Ordering Information (Note 4)

Part Number	Case	Packaging
(Type Number)-7* (Note 5)	SOD523	3,000/Tape & Reel

*Example: The part number for the 6.2 Volt device would be DDZ9691T-7.

- Notes:
1. No purposely added lead. Fully EU Directive 2002/95/EC (RoHS) & 2011/65/EU (RoHS 2) compliant.
 2. See <https://www.diodes.com/quality/lead-free/> for more information about Diodes Incorporated's definitions of Halogen- and Antimony-free, "Green" and Lead-free.
 3. Halogen- and Antimony-free "Green" products are defined as those which contain <900ppm bromine, <900ppm chlorine (<1500ppm total Br + Cl) and <1000ppm antimony compounds.
 4. For packaging details, go to our website at <http://www.diodes.com/products/packages.html>.
 5. Dispensed in every other cavity of the tape.

Marking Information

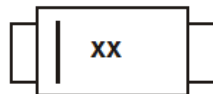

xx = Product Type Marking Code
(See Electrical Characteristics Table)

Maximum Ratings (@T_A = +25°C, unless otherwise specified.)

Characteristic	Symbol	Value	Unit
Forward Voltage @ I _F = 10mA	V _F	0.9	V

Thermal Characteristics

Characteristic	Symbol	Value	Unit
Power Dissipation (Note 6)	P _D	150	mW
Thermal Resistance, Junction to Ambient Air (Note 6)	R _{θJA}	833	°C/W
Operating and Storage Temperature Range	T _J , T _{STG}	-65 to +150	°C

Notes: 6. Device mounted on FR-4 PC board with recommended pad layout, which can be found on our website at <http://www.diodes.com/products/packages.html>.

Electrical Characteristics (@T_A = +25°C, unless otherwise specified.)

Type Number	Type Code	Zener Voltage Range (Note 7)				Maximum Reverse Leakage Current (Note 8)	
		V _Z @ I _{ZT}			I _{ZT}	I _R @ V _R	
		Nom (V)	Min (V)	Max (V)	μA	μA	V
DDZ9689T	HH	5.1	4.85	5.36	50	5	3
DDZ9690T	HJ	5.6	5.32	5.88	50	2	4
DDZ9691T	HK	6.2	5.89	6.51	50	1	5
DDZ9692T	HL	6.8	6.46	7.14	50	0.1	5.1
DDZ9693T	HM	7.5	7.13	7.88	50	0.1	5.7
DDZ9694T	HN	8.2	7.79	8.61	50	0.1	6.2
DDZ9696T	HP	9.1	8.65	9.56	50	0.1	6.9
DDZ9697T	HQ	10	9.50	10.50	50	0.1	7.6
DDZ9698T	HR	11	10.45	11.55	50	0.05	8.4
DDZ9699T	HS	12	11.40	12.60	50	0.05	9.1
DDZ9700T	HT	13	12.35	13.65	50	0.05	9.8
DDZ9701T	HU	14	13.30	14.70	50	0.05	10.6
DDZ9702T	HV	15	14.25	15.75	50	0.05	11.4
DDZ9703T	HW	16	15.20	16.80	50	0.05	12.1
DDZ9705T	HY	18	17.10	18.90	50	0.05	13.6
DDZ9707T	MD	20	19.00	21.00	50	0.05	15.2
DDZ9708T	ME	22	20.90	23.10	50	0.05	16.7
DDZ9709T	MF	24	22.80	25.20	50	0.05	18.2
DDZ9711T	MH	27	25.65	28.35	50	0.05	20.4
DDZ9712T	MJ	28	26.60	29.40	50	0.05	21.2
DDZ9713T	MK	30	28.50	31.50	50	0.05	22.8
DDZ9714T	ML	33	31.35	34.65	50	0.05	25.0
DDZ9715T	MM	36	34.20	37.80	50	0.05	27.3
DDZ9716T	MN	39	37.05	40.95	50	0.05	29.6
DDZ9717T	MO	43	40.85	45.15	50	0.05	32.6

Notes: 7. Nominal Zener voltage is measured with the device junction in thermal equilibrium at T_T = 30°C ±1°C.
8. Short duration pulse test used to minimize self-heating effect.

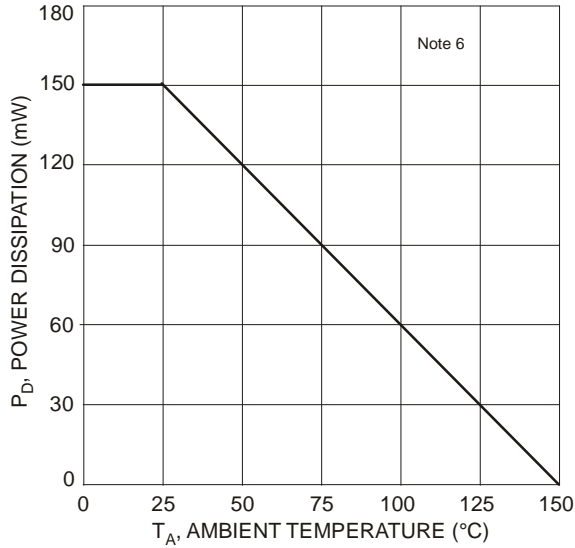

Fig. 1 Power Derating Curve

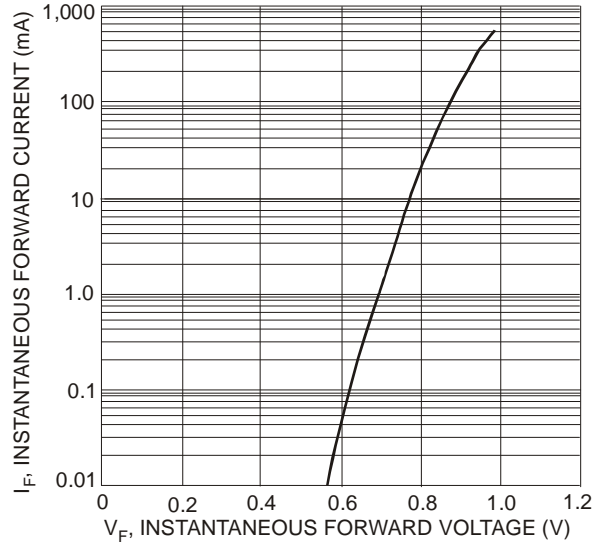

Fig. 2 Typical Forward Characteristics

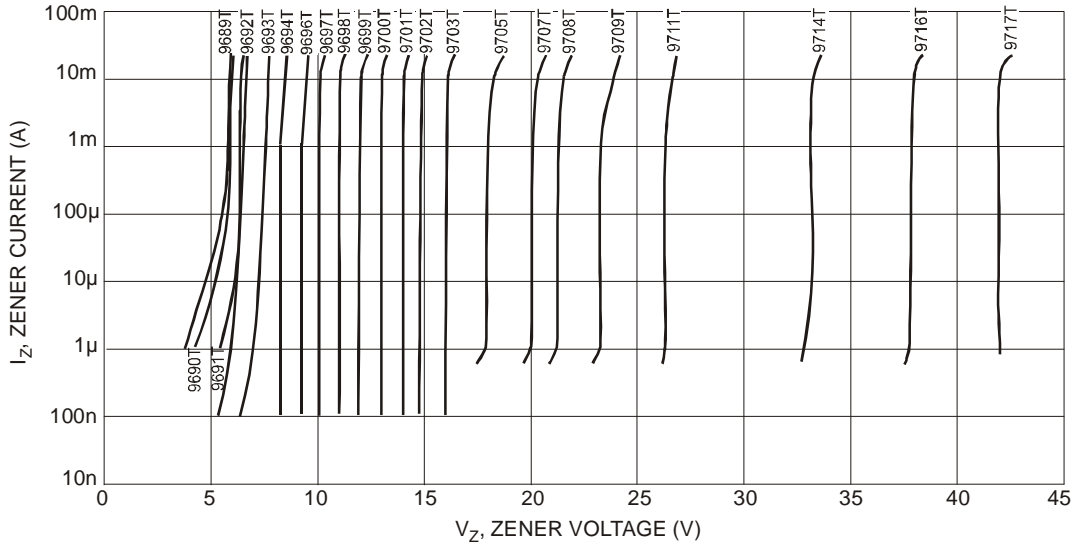

Fig. 3 Typical Zener Breakdown Characteristics

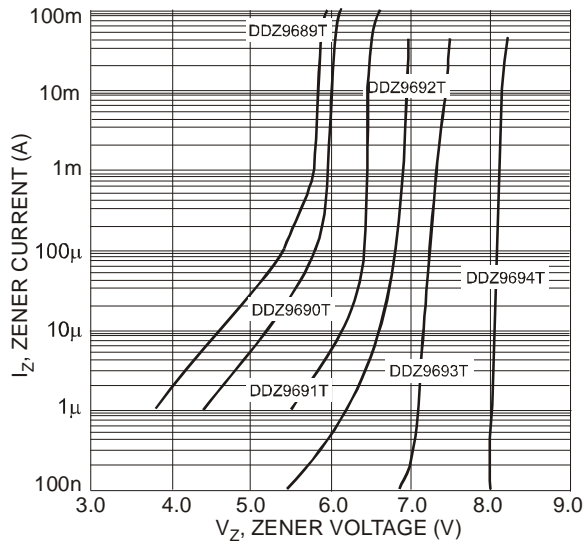

Fig. 4 Typical Zener Breakdown Characteristics, DDZ9692T - DDZ9694T

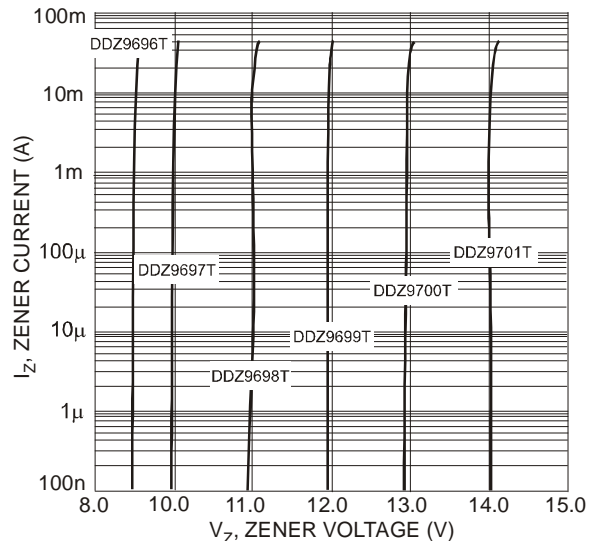

Fig. 5 Typical Zener Breakdown Characteristics, DDZ9696T - DDZ9701T



Fig. 6 Typical Zener Breakdown Characteristics, DDZ9702T - DDZ9705T

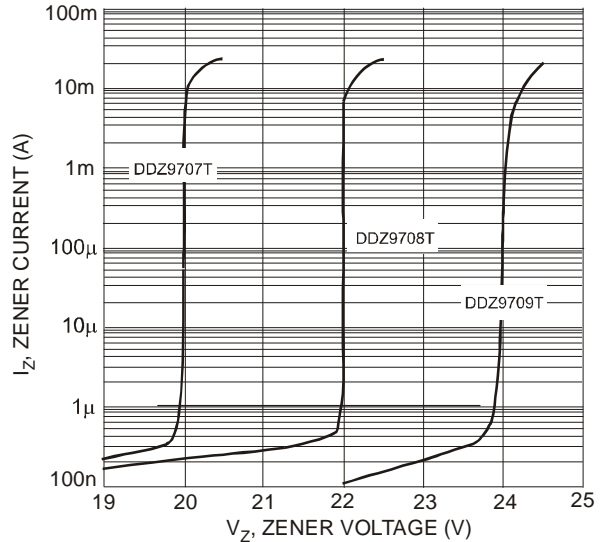

Fig. 7 Typical Zener Breakdown Characteristics, DDZ9707T - DDZ9709T



Fig. 8 Typical Zener Breakdown Characteristics, DDZ9711T - DDZ9715T

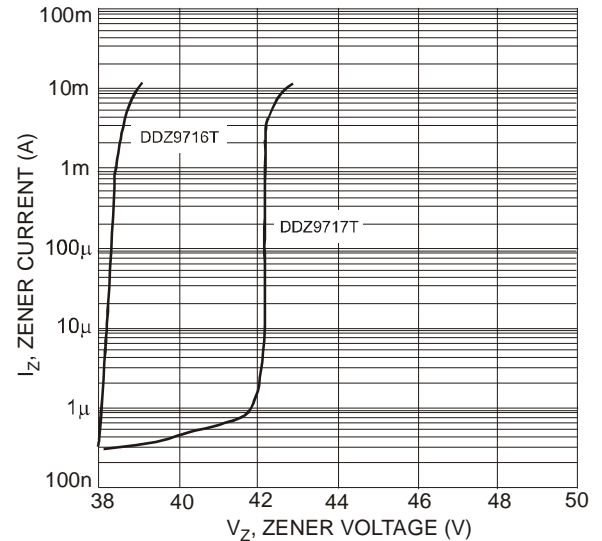

Fig. 9 Typical Zener Breakdown Characteristics, DDZ9716T - DDZ9717T



Fig. 10 Typical Zener Impedance Characteristics, DDZ9689T - DDZ9692T

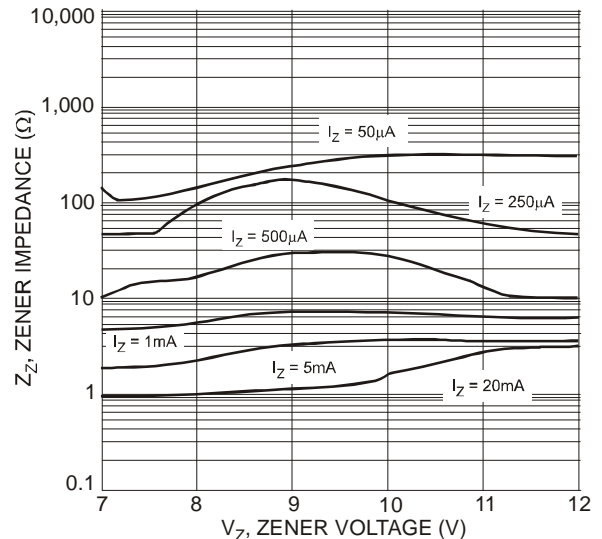

Fig. 11 Typical Zener Impedance Characteristics, DDZ9693T - DDZ9699T



Fig. 12 Typical Zener Impedance Characteristics, DDZ9699T - DDZ9705T



Fig. 13 Typical Zener Impedance Characteristics, DDZ9705T - DDZ9709T



Fig. 14 Typical Zener Impedance Characteristics, DDZ9709T - DDZ9714T



Fig. 15 Typical Zener Impedance Characteristics, DDZ9715T - DDZ9717T



Fig. 16 Typical Temperature Coefficient of Zener Voltage vs. Zener Voltage, DDZ9694T - DDZ9697T



Fig. 17 Typical Temperature Coefficient of Zener Voltage vs. Zener Voltage, DDZ9697T - DDZ9707T



Fig. 18 Typical Temperature Coefficient of Zener Voltage vs. Zener Voltage, DDZ9707T - DDZ9713T

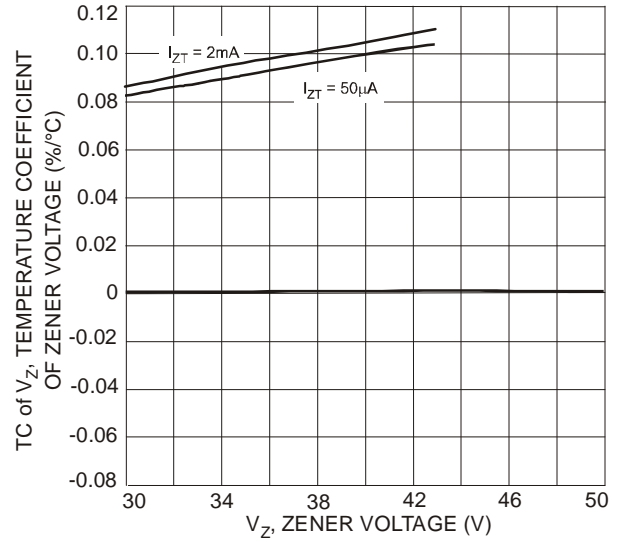
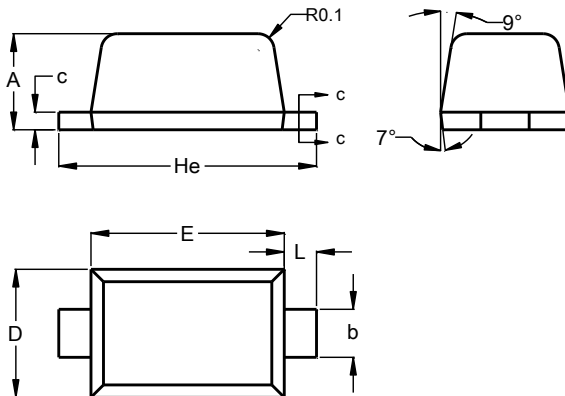

Fig. 19 Typical Temperature Coefficient of Zener Voltage vs. Zener Voltage, DDZ9713T - DDZ9717T

Package Outline Dimensions

Please see <http://www.diodes.com/package-outlines.html> for the latest version.



SOD523		
Dim	Min	Max
A	0.55	0.65
b	0.26	0.34
c	0.11	0.17
D	0.75	0.85
E	1.15	1.25
He	1.55	1.65
L	0.10	0.30
All Dimensions in mm		

Suggested Pad Layout

Please see <http://www.diodes.com/package-outlines.html> for the latest version.

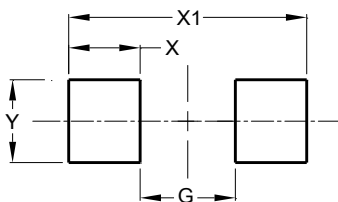

Dimensions	Value (in mm)
G	0.80
X	0.60
X1	2.00
Y	0.70

IMPORTANT NOTICE

DIODES INCORPORATED MAKES NO WARRANTY OF ANY KIND, EXPRESS OR IMPLIED, WITH REGARDS TO THIS DOCUMENT, INCLUDING, BUT NOT LIMITED TO, THE IMPLIED WARRANTIES OF MERCHANTABILITY AND FITNESS FOR A PARTICULAR PURPOSE (AND THEIR EQUIVALENTS UNDER THE LAWS OF ANY JURISDICTION).

Diodes Incorporated and its subsidiaries reserve the right to make modifications, enhancements, improvements, corrections or other changes without further notice to this document and any product described herein. Diodes Incorporated does not assume any liability arising out of the application or use of this document or any product described herein; neither does Diodes Incorporated convey any license under its patent or trademark rights, nor the rights of others. Any Customer or user of this document or products described herein in such applications shall assume all risks of such use and will agree to hold Diodes Incorporated and all the companies whose products are represented on Diodes Incorporated website, harmless against all damages.

Diodes Incorporated does not warrant or accept any liability whatsoever in respect of any products purchased through unauthorized sales channel. Should Customers purchase or use Diodes Incorporated products for any unintended or unauthorized application, Customers shall indemnify and hold Diodes Incorporated and its representatives harmless against all claims, damages, expenses, and attorney fees arising out of, directly or indirectly, any claim of personal injury or death associated with such unintended or unauthorized application.

Products described herein may be covered by one or more United States, international or foreign patents pending. Product names and markings noted herein may also be covered by one or more United States, international or foreign trademarks.

This document is written in English but may be translated into multiple languages for reference. Only the English version of this document is the final and determinative format released by Diodes Incorporated.

LIFE SUPPORT

Diodes Incorporated products are specifically not authorized for use as critical components in life support devices or systems without the express written approval of the Chief Executive Officer of Diodes Incorporated. As used herein:

A. Life support devices or systems are devices or systems which:

1. are intended to implant into the body, or
2. support or sustain life and whose failure to perform when properly used in accordance with instructions for use provided in the labeling can be reasonably expected to result in significant injury to the user.

B. A critical component is any component in a life support device or system whose failure to perform can be reasonably expected to cause the failure of the life support device or to affect its safety or effectiveness.

Customers represent that they have all necessary expertise in the safety and regulatory ramifications of their life support devices or systems, and acknowledge and agree that they are solely responsible for all legal, regulatory and safety-related requirements concerning their products and any use of Diodes Incorporated products in such safety-critical, life support devices or systems, notwithstanding any devices- or systems-related information or support that may be provided by Diodes Incorporated. Further, Customers must fully indemnify Diodes Incorporated and its representatives against any damages arising out of the use of Diodes Incorporated products in such safety-critical, life support devices or systems.

Copyright © 2017, Diodes Incorporated

www.diodes.com

Looking for pricing, stock, or lifecycle information?

Click below to explore more details on WIN SOURCE:

 [View DDZ9694T-7 on WIN SOURCE](#)

 [Diodes Incorporated](#) Information

Optimize Your Supply Chain with WIN SOURCE Solutions

-  Global Sourcing Solution
-  Obsolete Management
-  Cost Control Management
-  Shortage Management
-  Alternative Solution
-  Excess Inventory Management