



THE DATASHEET OF FOD819



FOD819 Series

FOD819 4-Pin DIP High Speed Phototransistor Optocouplers

Description

The FOD819 consists of a gallium arsenide (GaAs) infra-red emitting diode, driving a high speed photo detector with integrated base-to-emitter resistor, R_{BE} , in a 4-pin dual-in-line package. It is designed to be an improved replacement to the popular FOD817 Series when higher speed performance is required in isolated data signal transmission.

Features

- High Speed Performance ~ 30 kHz
- Current Transfer Ratio: 100% to 600%
- Minimum BV_{CEO} of 80 V Guaranteed
- Safety and Regulatory Approvals:
 - UL1577, 5,000 VAC_{RMS} for 1 Minute
 - DIN EN/IEC60747-5-5, 850 V Peak Working Insulation Voltage

Typical Applications

- Digital Logic Inputs
- Microprocessor Inputs
- Power Supply Monitor
- Twisted Pair Line Receiver
- Telephone Line Receiver



ON Semiconductor®

www.onsemi.com

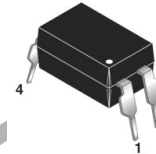

DIP 4 PINS

MARKING DIAGRAM

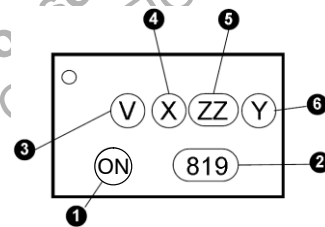

- 1. ON = Company Logo
- 2. 819 = Device Number
- 3. V = DIN EN/IEC60747-5-5 Option
- 4. X = One-Digit Year Code
- 5. ZZ = Digit Work Week
- 6. Y = Assembly Package Code

PIN CONNECTIONS

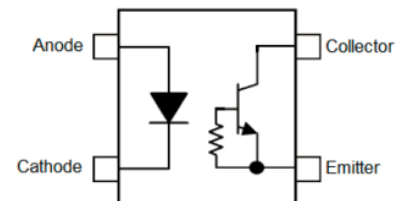

ORDERING INFORMATION

See detailed ordering and shipping information on page 7 of this data sheet.

FOD819 Series

Safety and Insulation Ratings

As per DIN EN/IEC 60747-5-5, this optocoupler is suitable for “safe electrical insulation” only within the safety limit data. Compliance with the safety ratings shall be ensured by means of protective circuits.

Table 1. SAFETY AND INSULATION RATINGS

Parameter		Characteristics
Installation Classifications per DIN VDE 0110/1.89 Table 1, For Rated Mains Voltage	< 150 V _{RMS}	I-IV
	< 300 V _{RMS}	I-III
Climatic Classification		55/115/21
Pollution Degree (DIN VDE 0110/1.89)		2
Comparative Tracking Index		175

Table 2.

Symbol	Parameter	Value	Unit
V _{PR}	Input-to-Output Test Voltage, Method A, V _{IORM} × 1.6 = V _{PR} , Type and Sample Test with t _m = 10 s, Partial Discharge < 5 pC	1360	V _{peak}
	Input-to-Output Test Voltage, Method B, V _{IORM} × 1.875 = V _{PR} , 100% Production Test with t _m = 1 s, Partial Discharge < 5 pC	1594	V _{peak}
V _{IORM}	Maximum Working Insulation Voltage	850	V _{peak}
V _{IOTM}	Highest Allowable Over-Voltage	8000	V _{peak}
	External Creepage	≥ 7	mm
	External Clearance	≥ 7	mm
	External Clearance (for Option W, 0.4" Lead Spacing)	≥ 10	mm
DTI	Distance Through Insulation (Insulation Thickness)	≥ 0.4	mm
T _S	Case Temperature (Note 1)	175	°C
I _{S,INPUT}	Input Current (Note 1)	400	mA
P _{S,OUTPUT}	Output Power (Note 1)	700	mW
R _{IO}	Insulation Resistance at T _S , V _{IO} = 500 V (Note 1)	> 10 ¹¹	Ω

1. Safety limit values – maximum values allowed in the event of a failure.

Table 3. ABSOLUTE MAXIMUM RATINGS

Symbol	Parameter	Value	Unit
TOTAL PACKAGE			
T _{STG}	Storage Temperature	-55 to +125	°C
T _{OPR}	Operating Temperature	-55 to +110	°C
T _J	Junction Temperature	-55 to +125	°C
T _{SOL}	Lead Solder Temperature	260 for 10 seconds	°C
θ _{JC}	Junction-to-Case Thermal Resistance	210	°C/W
P _{TOT}	Total Device Power Dissipation	200	mW
EMITTER			
I _F	Continuous Forward Current	50	mA
V _R	Reverse Voltage	6	V
P _D	Power Dissipation	70	mW
	Derate Above 100°C	1.7	mW/°C

FOD819 Series

Table 3. ABSOLUTE MAXIMUM RATINGS (continued)

Symbol	Parameter	Value	Unit
DETECTOR			
V_{CEO}	Collector–Emitter Voltage	80	V
V_{ECO}	Emitter–Collector Voltage	2	V
I_C	Continuous Collector Current	30	mA
P_C	Collector Power Dissipation	150	mW
	Derate Above 90°C	2.9	mW/°C

Stresses exceeding those listed in the Maximum Ratings table may damage the device. If any of these limits are exceeded, device functionality should not be assumed, damage may occur and reliability may be affected.

Electrical Characteristics

Table 4. INDIVIDUAL COMPONENT CHARACTERISTICS ($T_A = 25^\circ\text{C}$ unless otherwise specified)

Symbol	Parameter	Test Conditions	Min.	Typ.	Max.	Unit
EMITTER						
V_F	Forward Voltage	$I_F = 1.5\text{ mA}$		1.2	1.4	V
I_R	Reverse Current	$V_R = 4.0\text{ V}$			10	μA
C_t	Terminal Capacitance	$V = 0, f = 1\text{ kHz}$		30		pF
DETECTOR						
I_{CEO}	Collector Dark Current	$V_{CE} = 40\text{ V}, I_F = 0$			100	nA
BV_{CEO}	Collector–Emitter Breakdown Voltage	$I_C = 0.1\text{ mA}, I_F = 0$	80	150		V
BV_{ECO}	Emitter–Collector Breakdown Voltage	$I_E = 0.1\text{ mA}, I_F = 0$	2	7		V

DC TRANSFER CHARACTERISTICS

CTR	Current Transfer Ratio (Note 2)	$I_F = 1.5\text{ mA}, V_{CE} = 5\text{ V}$	100		600	%
$V_{CE(SAT)}$	Saturation Voltage	$I_F = 1.5\text{ mA}, I_C = 0.2\text{ mA}$			0.3	V
$I_{C(OFF)}$	OFF–state collector current	$V_F = 0.7\text{ V}, V_{CE} = 40\text{ V}$			10	μA

AC TRANSFER CHARACTERISTICS

t_R	Rise Time (Saturated)	$I_F = 1.5\text{ mA}, V_{CC} = 5\text{ V}, R_L = 10\text{ k}\Omega$ (Note 3)		12		μs
t_F	Fall Time (Saturated)			20		μs
t_{PHL}	Propagation Delay Time High–to–Low	$I_F = 1.5\text{ mA}, V_{CC} = 5\text{ V}, R_L = 10\text{ k}\Omega$ (Note 3)		9	30	μs
t_{PLH}	Propagation Delay Time Low–to–High			18	30	μs

- Current Transfer Ratio (CTR) = $I_C / I_F \times 100\%$.
- Refer to test circuit setup.

Table 5. ISOLATION CHARACTERISTICS ($T_A = 25^\circ\text{C}$ unless otherwise specified)

Symbol	Parameter	Test Conditions	Min.	Typ.	Max.	Unit
V_{ISO}	Input–Output Isolation Voltage (Note 4)	$f = 60\text{ Hz}, t = 1\text{ minutes},$ $I_{I-O} \leq 2\text{ }\mu\text{A}$	5000			$V_{AC(RMS)}$
R_{ISO}	Isolation Resistance	$V_{I-O} = 500\text{ V}_{DC}$		1×10^{11}		Ω
C_{ISO}	Isolation Capacitance	$V_{I-O} = 0, f = 1\text{ MHz}$		0.6	1.0	pf

- For this test, Pins 1 and 2 are common, and Pins 3 and 4 are common.

Typical Performance Curves

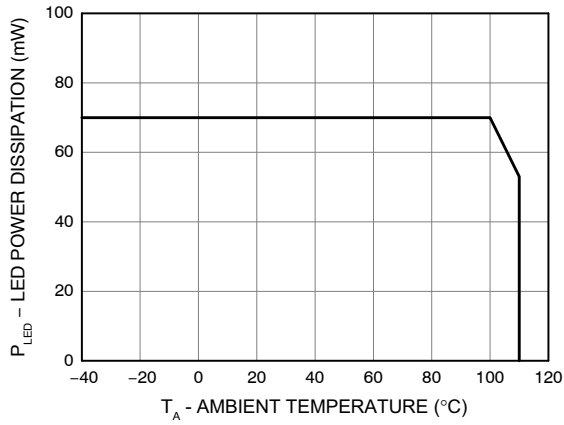

Figure 1. LED Power Dissipation vs. Ambient Temperature

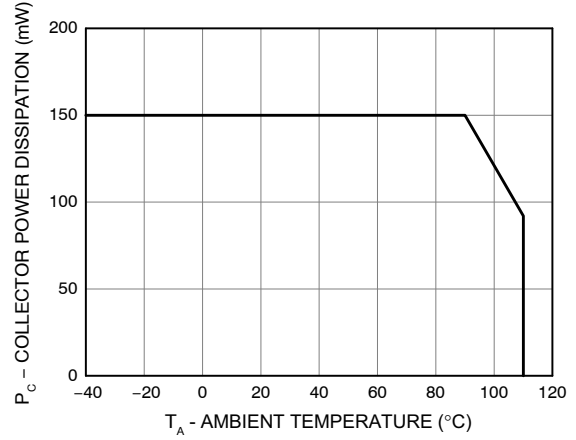

Figure 2. Collector Power Dissipation vs. Ambient Temperature

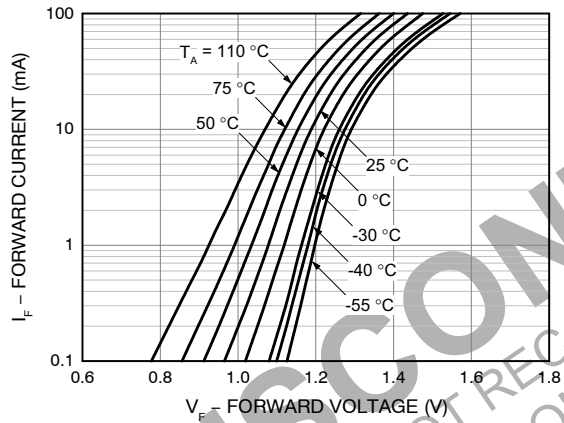

Figure 3. Forward Current vs. Forward Voltage

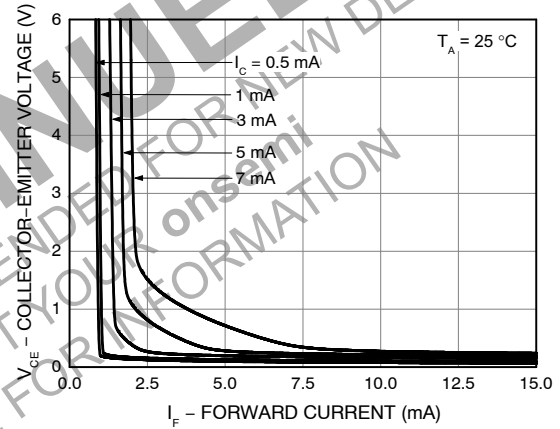

Figure 4. Collector-Emitter Voltage vs. Forward Current

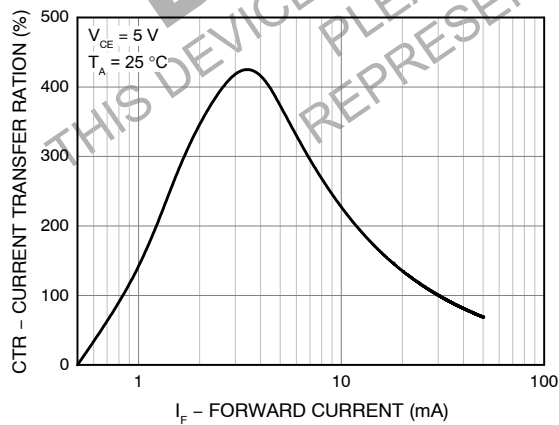

Figure 5. Current Transfer Ratio vs. Forward Current

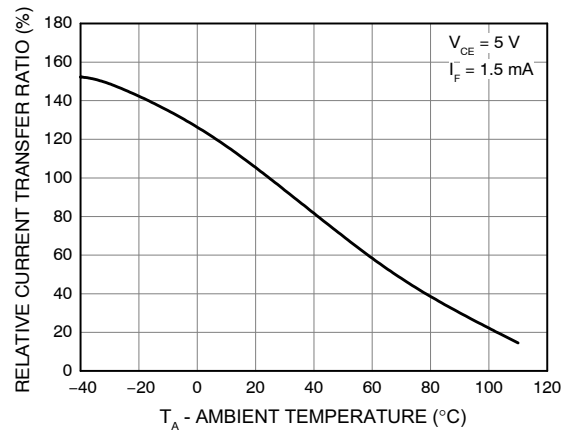

Figure 6. Relative Current Transfer Ratio vs. Ambient Temperature

FOD819 Series

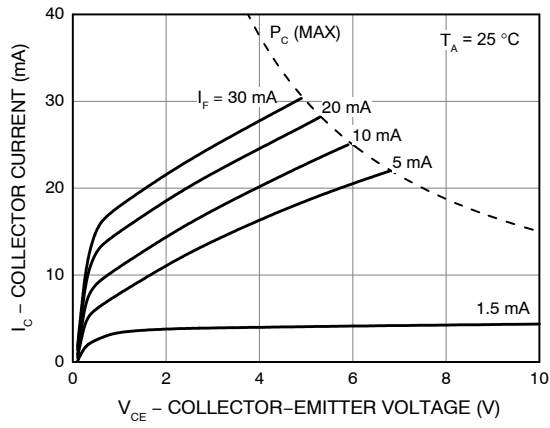

Figure 7. Collector Current vs. Collector-Emitter Voltage

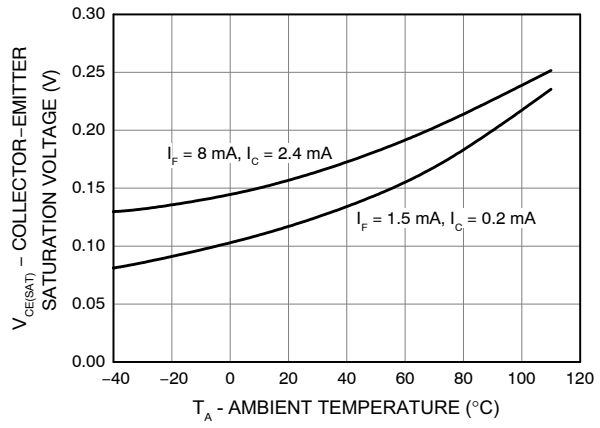

Figure 8. Collector-Emitter Saturation Voltage vs. Ambient Temperature

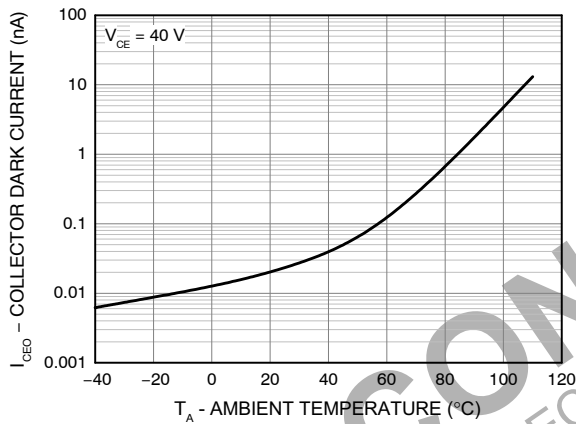

Figure 9. Collector Dark Current vs. Ambient Temperature

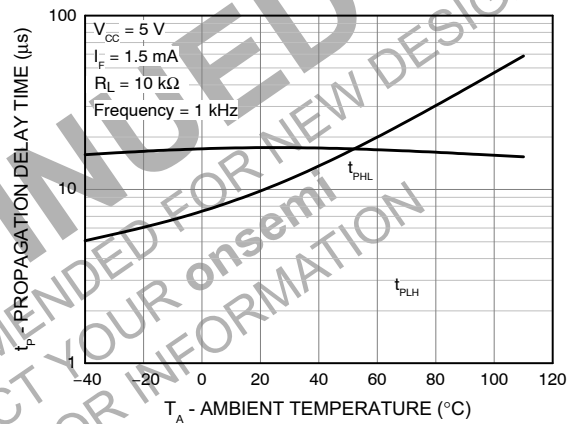

Figure 10. Propagation Delay vs. Ambient Temperature

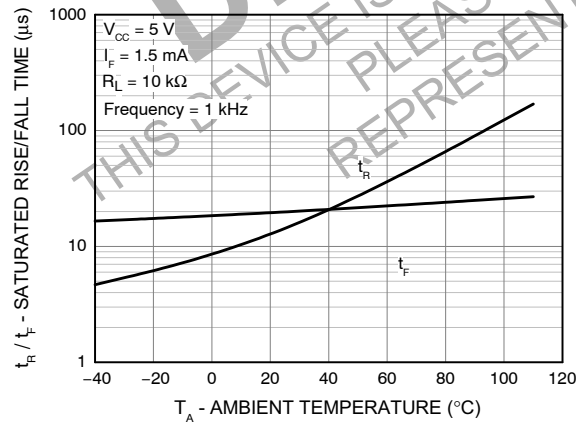

Figure 11. Saturated Rise / Fall Time vs. Ambient Temperature

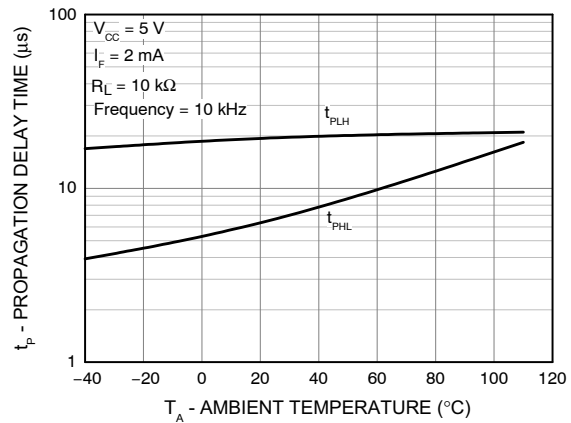

Figure 12. Propagation Delay vs. Ambient Temperature

FOD819 Series

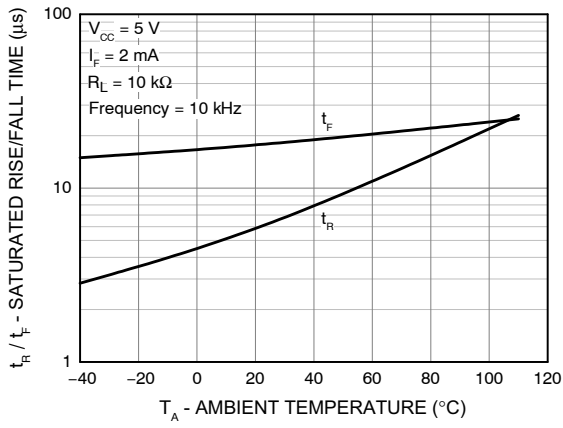

Figure 13. Collector Dark Current vs. Ambient Temperature

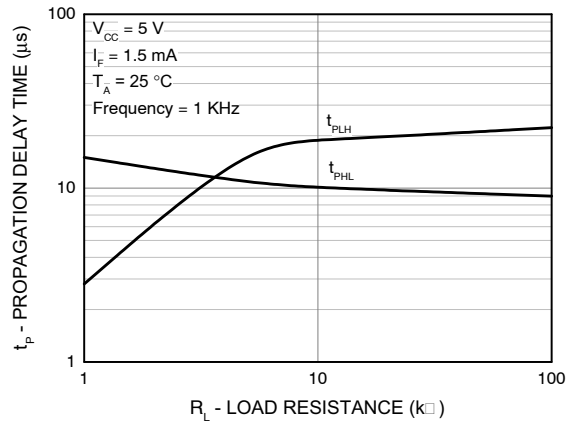

Figure 14. Propagation Delay vs. Ambient Temperature

Test Circuit

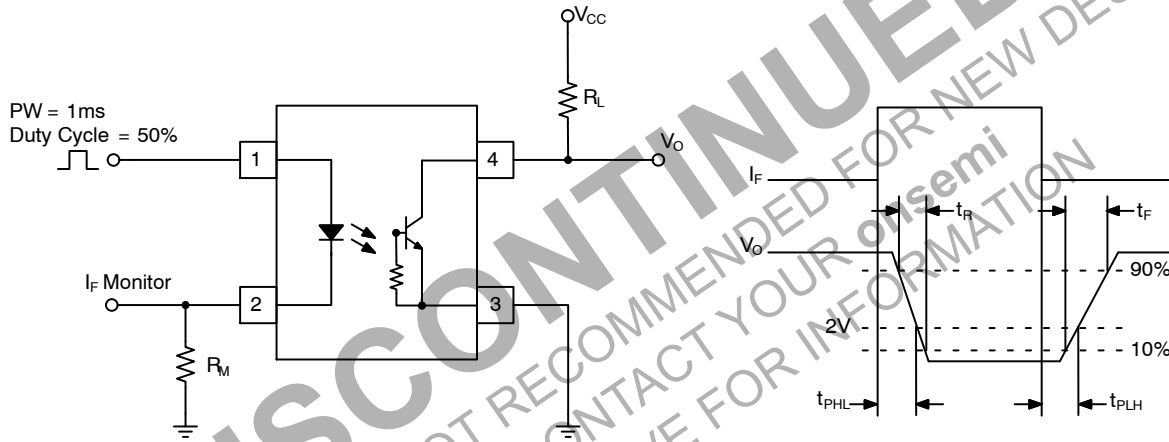
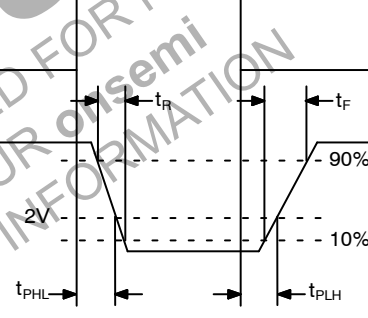

Figure 15. Test Circuit for Response Time

Figure 16. Timing Diagram



FOD819 Series

Reflow Profile

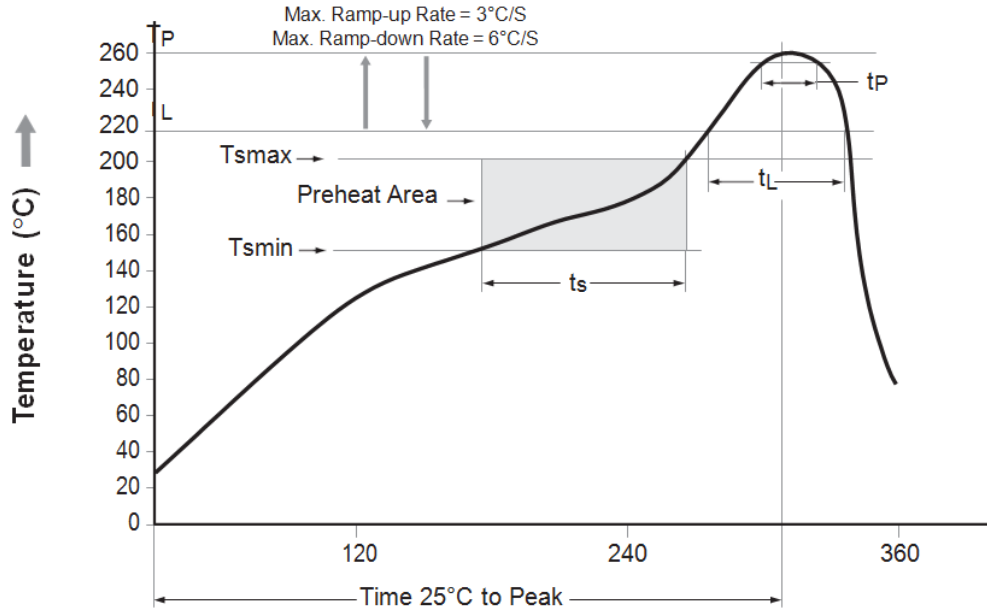

Figure 17. Reflow Profile

Table 6.

Profile Feature	Pb-Free Assembly Profile
Temperature Min. (T_{smin})	150°C
Temperature Max. (T_{smax})	200°C
Time (t_s) from (T_{smin} to T_{smax})	60–120 seconds
Ramp-up Rate (t_L to t_p)	3°C/second max.
Liquidous Temperature (T_L)	217°C
Time (t_L) Maintained Above (T_L)	60–150 seconds
Peak Body Package Temperature	260°C +0°C / -5°C
Time (t_p) within 5°C of 260°C	30 seconds
Ramp-down Rate (T_p to T_L)	6°C / second max.
Time 25°C to Peak Temperature	8 minutes max.

Table 7. ORDERING INFORMATION

Part Number	Package	Packing Method †
FOD819	DIP 4-Pin	Tube (100 units per tube)
FOD819S	SMT 4-Pin (Lead Bend)	Tube (100 units per tube)
FOD819SD	SMT 4-Pin (Lead Bend)	Tape and Reel (1,000 units per reel)
FOD819300	DIP 4-Pin, DIN EN/IEC60747-5-5 option	Tube (100 units per tube)
FOD8193S	SMT 4-Pin (Lead Bend), DIN EN/IEC60747-5-5 option	Tube (100 units per tube)
FOD8193SD	SMT 4-Pin (Lead Bend), DIN EN/IEC60747-5-5 option	Tape and Reel (1,000 units per reel)
FOD819300W	DIP 4-Pin, 0.4" Lead Spacing, DIN EN/IEC60747-5-5 option	Tube (100 units per tube)

†For information on tape and reel specifications, including part orientation and tape sizes, please refer to our Tape and Reel Packaging Specification Brochure, BRD8011/D.

FOD819 Series

PACKAGE DIMENSIONS

PDIP4 4.6 x 6.5, 2.54P
CASE 646CD
ISSUE O

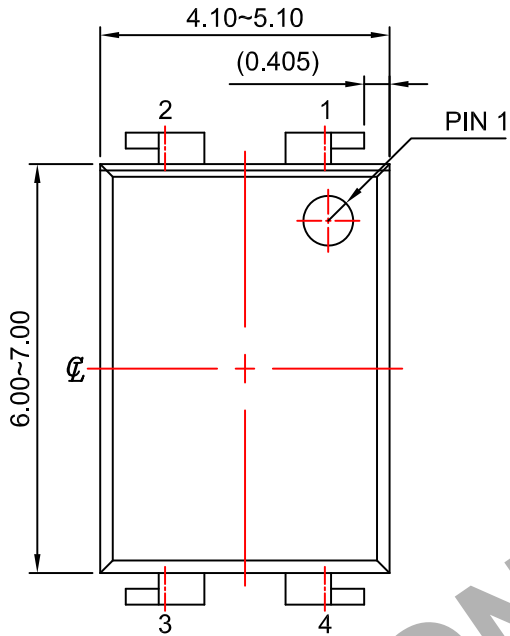

NOTES:

- A) NO STANDARD APPLIES TO THIS PACKAGE.
- B) ALL DIMENSIONS ARE IN MILLIMETERS.
- C) DIMENSIONS ARE EXCLUSIVE OF BURRS, MOLD FLASH, AND TIE BAR EXTRUSION

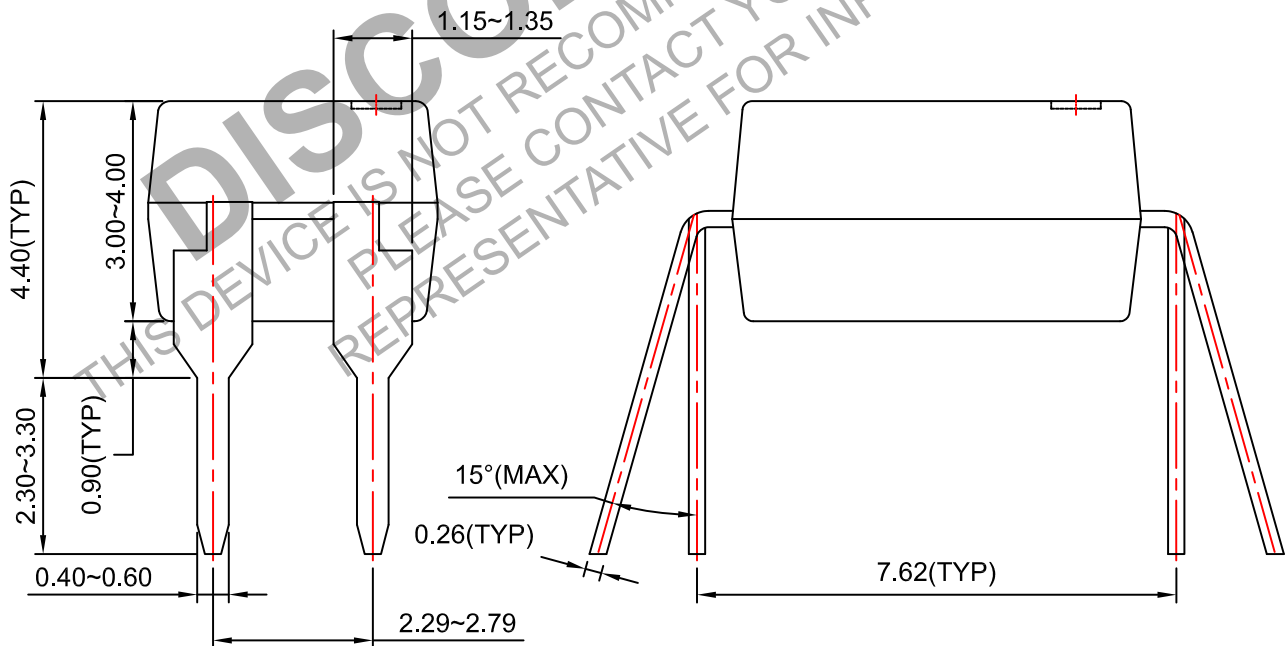

FOD819 Series

PDIP4 4.6 x 6.5, 2.54P
CASE 646CA
ISSUE O

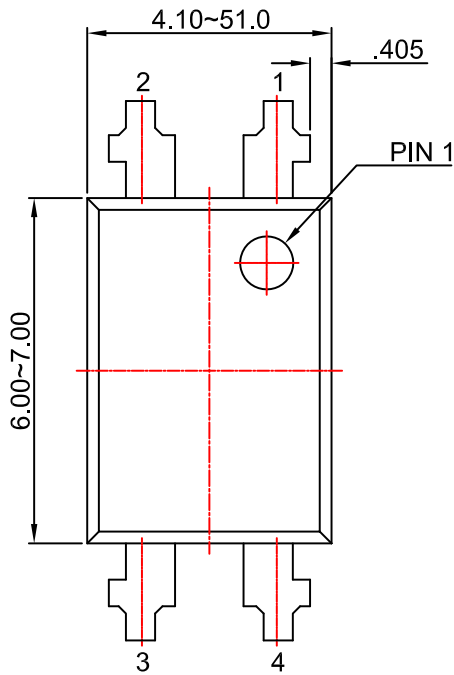

NOTES:

- A) NO STANDARD APPLIES TO THIS PACKAGE.
- B) ALL DIMENSIONS ARE IN MILLIMETERS.
- C) DIMENSIONS ARE EXCLUSIVE OF BURRS, MOLD FLASH, AND TIE BAR EXTRUSION

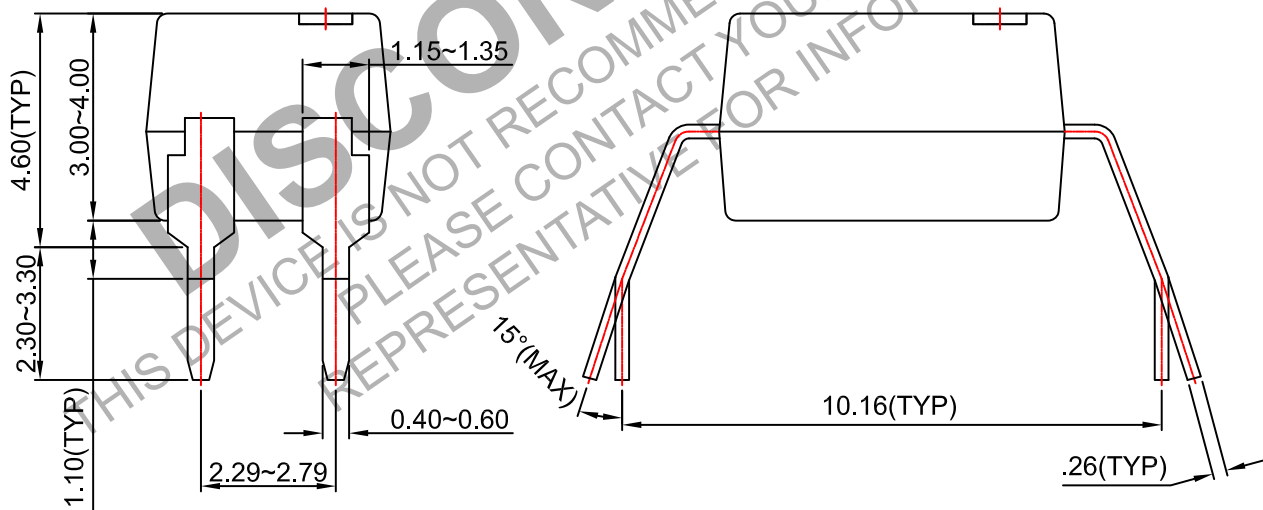

FOD819 Series

PDIP4 GW
CASE 709AH
ISSUE A

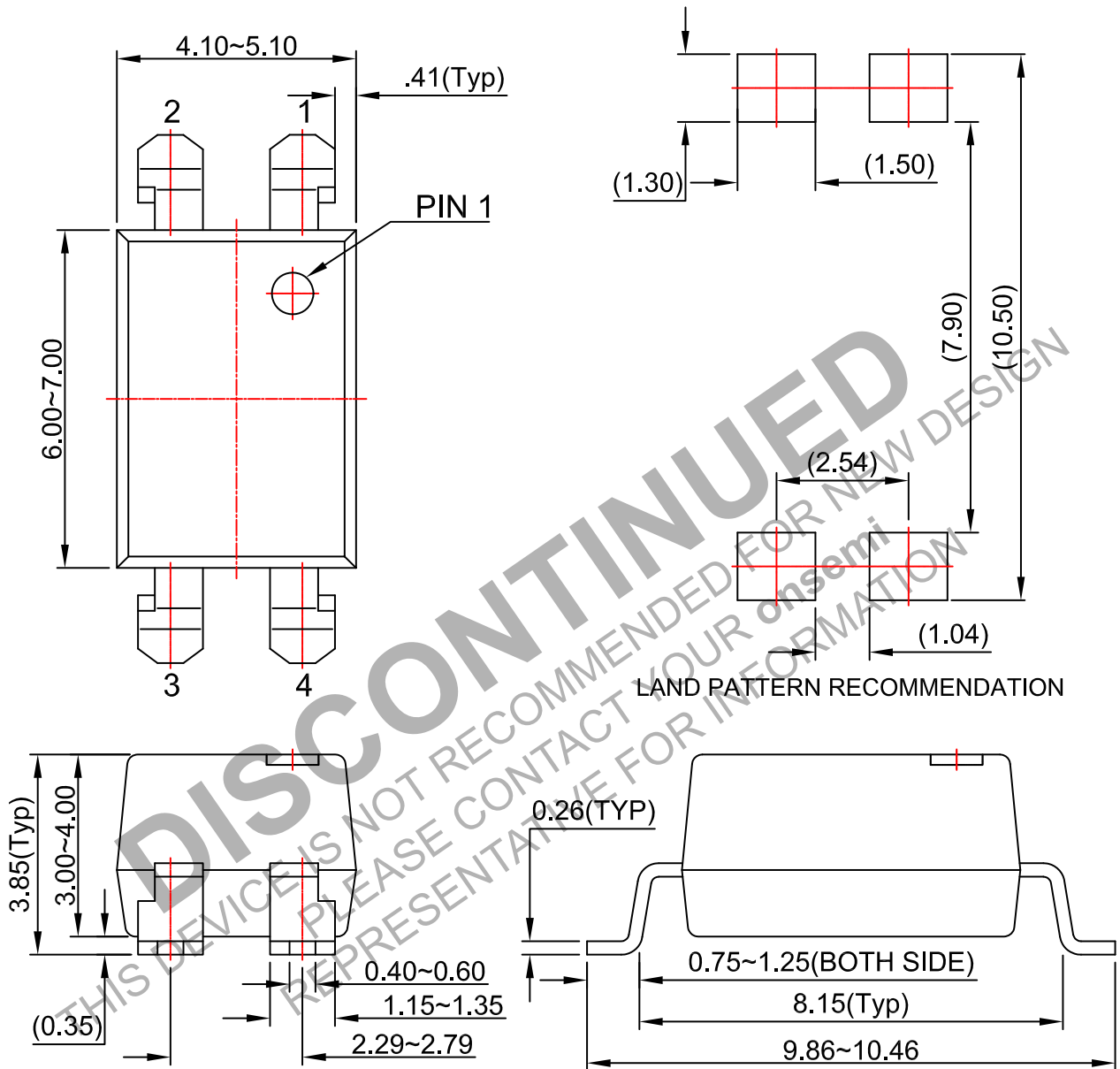

NOTES:

- A) NO STANDARD APPLIES TO THIS PACKAGE.
- B) ALL DIMENSIONS ARE IN MILLIMETERS.
- C) DIMENSIONS ARE EXCLUSIVE OF BURRS, MOLD FLASH, AND TIE BAR EXTRUSION

DISCONTINUED
THIS DEVICE IS NOT RECOMMENDED FOR NEW DESIGN
PLEASE CONTACT YOUR onsemi
REPRESENTATIVE FOR INFORMATION

ON Semiconductor and  are trademarks of Semiconductor Components Industries, LLC dba ON Semiconductor or its subsidiaries in the United States and/or other countries. ON Semiconductor owns the rights to a number of patents, trademarks, copyrights, trade secrets, and other intellectual property. A listing of ON Semiconductor's product/patent coverage may be accessed at www.onsemi.com/site/pdf/Patent-Marking.pdf. ON Semiconductor reserves the right to make changes without further notice to any products herein. ON Semiconductor makes no warranty, representation or guarantee regarding the suitability of its products for any particular purpose, nor does ON Semiconductor assume any liability arising out of the application or use of any product or circuit, and specifically disclaims any and all liability, including without limitation special, consequential or incidental damages. Buyer is responsible for its products and applications using ON Semiconductor products, including compliance with all laws, regulations and safety requirements or standards, regardless of any support or applications information provided by ON Semiconductor. "Typical" parameters which may be provided in ON Semiconductor data sheets and/or specifications can and do vary in different applications and actual performance may vary over time. All operating parameters, including "Typicals" must be validated for each customer application by customer's technical experts. ON Semiconductor does not convey any license under its patent rights nor the rights of others. ON Semiconductor products are not designed, intended, or authorized for use as a critical component in life support systems or any FDA Class 3 medical devices or medical devices with a same or similar classification in a foreign jurisdiction or any devices intended for implantation in the human body. Should Buyer purchase or use ON Semiconductor products for any such unintended or unauthorized application, Buyer shall indemnify and hold ON Semiconductor and its officers, employees, subsidiaries, affiliates, and distributors harmless against all claims, costs, damages, and expenses, and reasonable attorney fees arising out of, directly or indirectly, any claim of personal injury or death associated with such unintended or unauthorized use, even if such claim alleges that ON Semiconductor was negligent regarding the design or manufacture of the part. ON Semiconductor is an Equal Opportunity/Affirmative Action Employer. This literature is subject to all applicable copyright laws and is not for resale in any manner.

PUBLICATION ORDERING INFORMATION

LITERATURE FULFILLMENT:

Literature Distribution Center for ON Semiconductor
19521 E. 32nd Pkwy, Aurora, Colorado 80011 USA
Phone: 303-675-2175 or 800-344-3860 Toll Free USA/Canada
Fax: 303-675-2176 or 800-344-3867 Toll Free USA/Canada
Email: orderlit@onsemi.com



N. American Technical Support: 800-282-9855 Toll Free
USA/Canada
Europe, Middle East and Africa Technical Support:
Phone: 421 33 790 2910

ON Semiconductor Website: www.onsemi.com
Order Literature: <http://www.onsemi.com/orderlit>

For additional information, please contact your local Sales Representative

Looking for pricing, stock, or lifecycle information?

Click below to explore more details on WIN SOURCE:

-  [View FOD819 on WIN SOURCE](#)
-  [ON Semiconductor Information](#)

Optimize Your Supply Chain with WIN SOURCE Solutions

-  Global Sourcing Solution
-  Obsolete Management
-  Cost Control Management
-  Shortage Management
-  Alternative Solution
-  Excess Inventory Management