



**THE DATASHEET OF
DDZX9V1C-7**



Features

- Very Sharp Breakdown Characteristics
- 300mW Power Dissipation on FR-4 PCB
- Very Tight Tolerance on V_Z
- Ideally Suited for Automated Assembly Processes
- Very Low Leakage Current
- **Totally Lead-Free & Fully RoHS Compliant (Notes 1 & 2)**
- **Halogen and Antimony Free. "Green" Device (Note 3)**
- **Qualified to AEC-Q101 Standards for High Reliability**
- **An Automotive-Compliant Part is Available Under Separate Datasheet ([DDZX5V1BQ](#))**

Mechanical Data

- Case: SOT23
- Case Material: Molded Plastic, "Green" Molding Compound. UL Flammability Classification Rating 94V-0
- Moisture Sensitivity: Level 1 per J-STD-020
- Terminals: Finish - Matte Tin Annealed over Alloy 42 Leadframe. Solderable per MIL-STD-202, Method 208
- Polarity: See Diagram
- Weight: 0.008 grams (Approximate)

SOT23



Top View

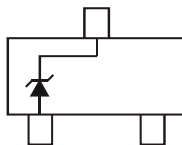

Device Schematic

Ordering Information (Note 4)

Part Number	Compliance	Case	Packaging
(Type Number)-7 (Note 5)	Standard	SOT23	3,000/Tape & Reel
(Type Number)-13 (Note 6)	Standard	SOT23	10,000/Tape & Reel

- Notes:
1. No purposely added lead. Fully EU Directive 2002/95/EC (RoHS) & 2011/65/EU (RoHS 2) compliant.
 2. See http://www.diodes.com/quality/lead_free.html for more information about Diodes Incorporated's definitions of Halogen- and Antimony-free, "Green" and Lead-free.
 3. Halogen- and Antimony-free "Green" products are defined as those which contain <900ppm bromine, <900ppm chlorine (<1500ppm total Br + Cl) and <1000ppm antimony compounds.
 4. For Packaging Details, go to our website at <http://www.diodes.com>.
 5. Add "-7" to the appropriate type number in Electrical Characteristics Table. Example: 6.2V Zener = DDZX6V2B-7.
 6. Add "-13" to the appropriate type number in Electrical Characteristics Table. Example: 10V Zener = DDZX10C-13. Please note: Not all voltages are available in 13" reel size. Please contact the Diodes Inc. Sales Department for assistance in ordering 13" reel size devices.

Marking Information



xx = Product Type Marking Code
(See Electrical Characteristics Table)
YM = Date Code Marking for Shanghai Assembly / Test site
Y = Year (ex: Z = 2012)
M = Month (ex: 9 = September)

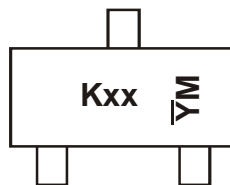

xx = Product Type Marking Code
(See Electrical Characteristics Table)
YM = Date Code Marking for Chengdu Assembly / Test site
Y = Year (ex: Z = 2012)
M = Month (ex: 9 = September)

Date Code Key

Year	2010	2011	2012	2013	2014	2015	2016	2017	2018	2019	2020
Code	X	Y	Z	A	B	C	D	E	F	G	H

Month	Jan	Feb	Mar	Apr	May	Jun	Jul	Aug	Sep	Oct	Nov	Dec
Code	1	2	3	4	5	6	7	8	9	O	N	D

Maximum Ratings (@T_A = +25°C, unless otherwise specified.)

Characteristic	Symbol	Value	Unit
Forward Voltage @ I _F = 10mA	V _F	0.9	V

Thermal Characteristics

Characteristic	Symbol	Value	Unit
Power Dissipation (Note 7)	P _D	300	mW
Thermal Resistance, Junction to Ambient Air (Note 7)	R _{θJA}	417	°C/W
Operating and Storage Temperature Range	T _J , T _{STG}	-65 to +150	°C

Note: 7. Device mounted on FR-4 PCB with recommended pad layout, which can be found on our website at <http://www.diodes.com>.

Electrical Characteristics (@T_A = +25°C, unless otherwise specified.)

Type Number	Marking Code	Zener Voltage Range (Note 8)			Maximum Zener Impedance f = 1kHz			Maximum Reverse Current (Note 9)	
		V _Z @ I _{ZT}		I _{ZT}	Z _{ZT} @ I _{ZT}	Z _{ZK} @ I _{ZK}	I _{ZK}	I _R	@ V _R
		Min (V)	Max (V)	mA	Ω	Ω	mA	μA	V
DDZX5V1B	KM	4.94	5.20	20	17	480	1	5	1.5
DDZX5V6B	KN	5.45	5.73	20	11	400	1	0.5	2.5
DDZX6V2B	KO	5.96	6.27	20	7	150	1	0.5	4.0
DDZX6V8C	YP	6.66	7.01	20	5	150	0.5	0.5	5.0
DDZX7V5C	YQ	7.29	7.67	20	6	120	0.5	0.5	6.0
DDZX8V2C	YR	8.03	8.45	20	8	120	0.5	0.5	6.5
DDZX9V1C	YS	8.83	9.30	20	8	120	0.5	0.5	7.0
DDZX10C	YT	9.70	10.20	20	8	120	0.5	0.1	8.0
DDZX11C	YU	10.82	11.38	10	10	120	0.5	0.1	8.4
DDZX12C	YV	11.74	12.35	10	12	110	0.5	0.1	9.1
DDZX13B	KW	12.55	13.21	10	14	110	0.5	0.1	10.0
DDZX14	GX	13.65	14.35	10	16	110	0.5	0.05	11.0
DDZX15	GY	14.80	15.57	10	18	150	0.5	0.05	12.0
DDZX16	YY	15.69	16.51	10	18	150	0.5	0.05	12.0
DDZX18C	YZ	17.42	18.33	10	23	150	0.5	0.05	14.0
DDZX20C	PJ	19.23	20.22	10	28	200	0.5	0.05	15.0
DDZX22D	2K	21.52	22.63	5	30	200	0.5	0.05	17.0
DDZX24C	PL	23.12	24.31	5	35	200	0.5	0.05	19.0
DDZX26	ZM	24.97	26.26	5	45	250	0.5	0.05	21.0
DDZX27D	2M	26.29	27.64	5	45	250	0.5	0.05	21.0
DDZX30D	2N	29.02	30.51	5	55	250	0.5	0.05	23.0
DDZX33	RP	32.14	33.79	5	75	250	0.5	0.05	27.0
DDZX36	ZQ	35.36	37.19	5	85	250	0.5	0.05	30.0
DDZX39F	5Q	38.02	39.98	5	85	250	0.5	0.05	30.0
DDZX43	ZR	42.14	43.86	5	90	—	—	0.05	33.0

Notes: 8. The zener voltage is measured <40ms after power is supplied.
 9. Short duration pulse test used to minimize self-heating effect.



Fig. 3 Typical Zener Breakdown Characteristics

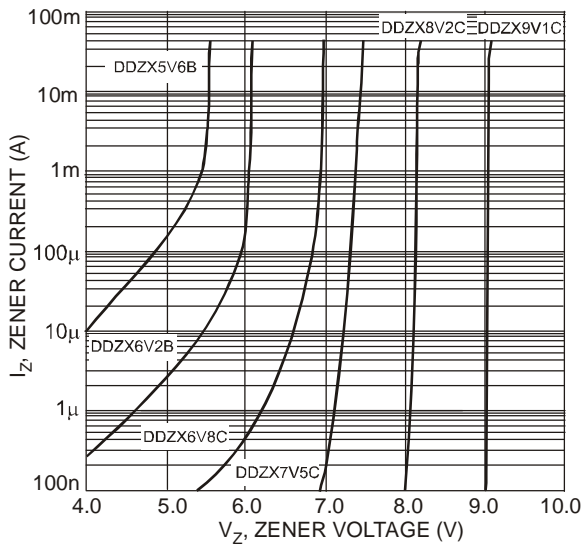

Fig. 4 Typical Zener Breakdown Characteristics DDZX5V6B - DDZX9V1C

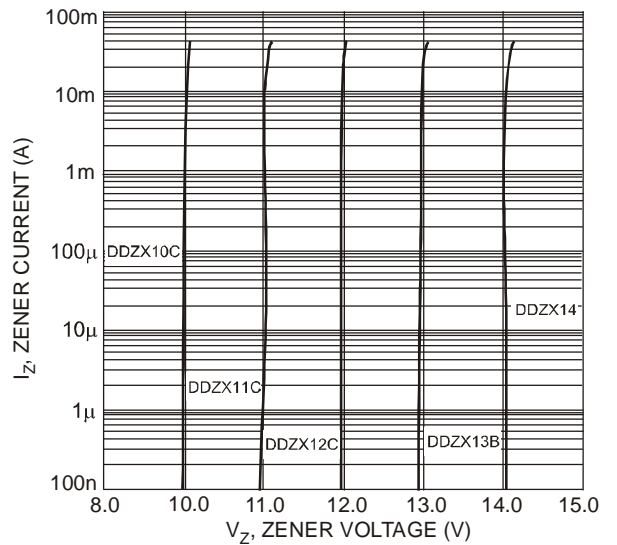

Fig. 5 Typical Zener Breakdown Characteristics DDZX10C - DDZX14



Fig. 6 Typical Zener Breakdown Characteristics DDZX15 - DDZX18C

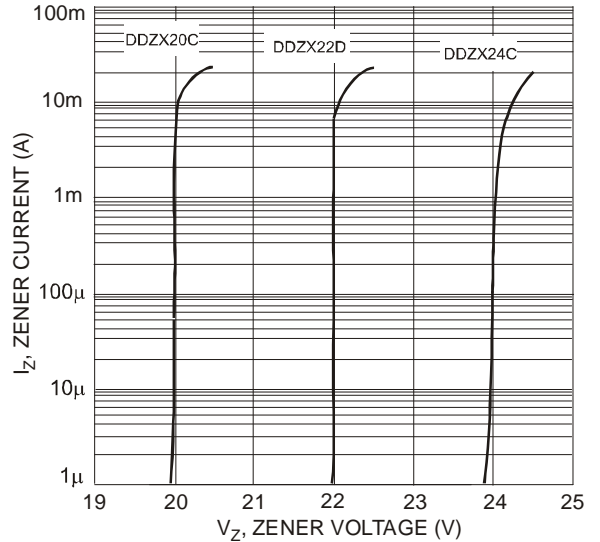

Fig. 7 Typical Zener Breakdown Characteristics DDZX20C - DDZX24C

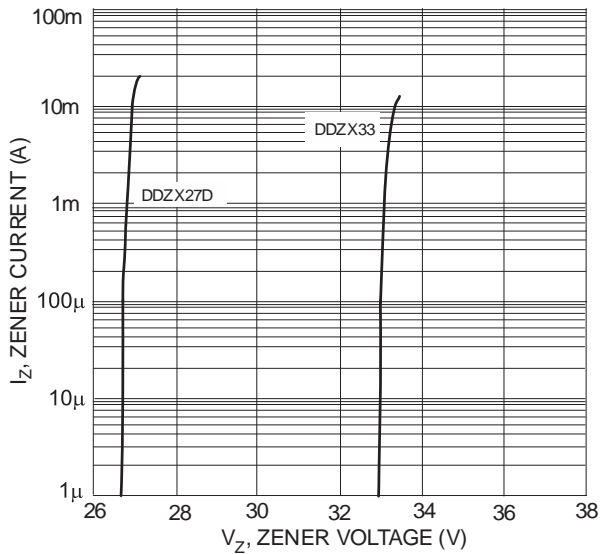

Fig. 8 Typical Zener Breakdown Characteristics DDZX27D - DDZX33

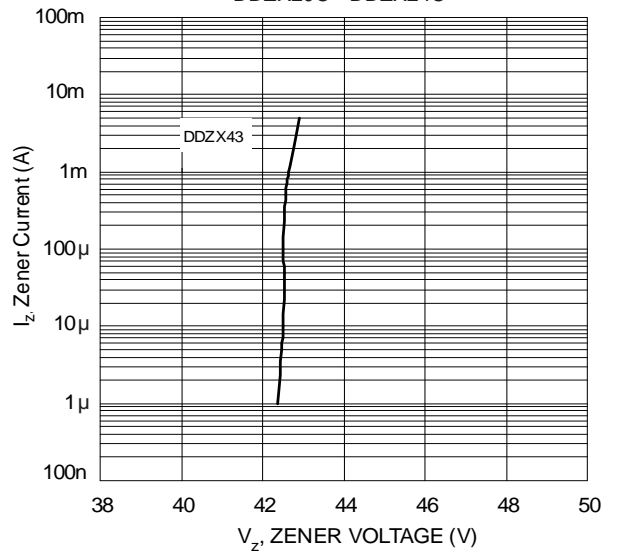

Fig. 9 Typical Zener Breakdown Characteristics DDZX43



Fig. 10 Typical Total Capacitance vs. Nominal Zener Voltage



Fig. 11 Typical Zener Impedance Characteristics, DDZX5V6B - DDZX12C



Fig. 12 Typical Zener Impedance Characteristics, DDZX12C - DDZX18C



Fig. 13 Typical Zener Impedance Characteristics, DDZX18C - DDZX24C



Fig. 14 Typical Zener Impedance Characteristics, DDZX24C - DDZX33



Fig. 15 Typical Zener Impedance Characteristics, DDZX36 - DDZX43



Fig. 16 Typical Temperature Coefficient of Zener Voltage vs. Zener Voltage, DDZX6V2B-DDZX10C

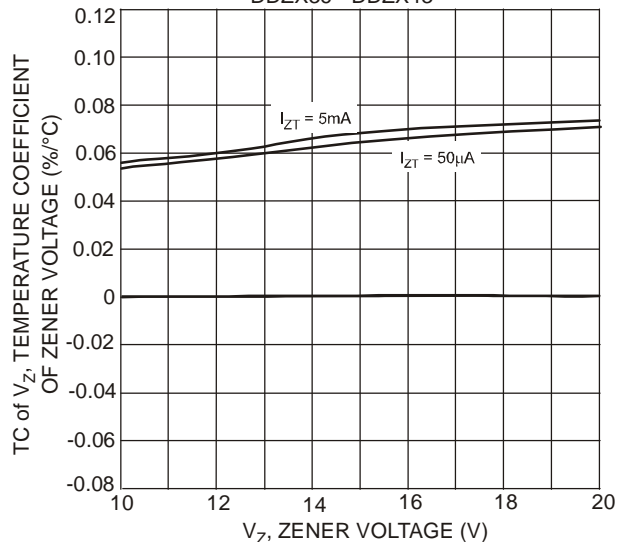

Fig. 17 Typical Temperature Coefficient of Zener Voltage vs. Zener Voltage, DDZX10C-DDZX20C



Fig. 18 Typical Temperature Coefficient of Zener Voltage vs. Zener Voltage, DDZX20C-DDZX30D

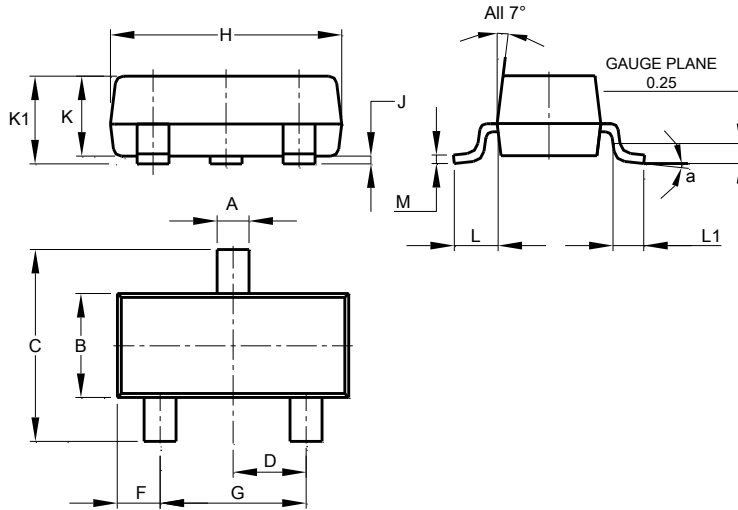

Fig. 19 Typical Temperature Coefficient of Zener Voltage vs. Zener Voltage, DDZX30D-DDZX43

Package Outline Dimensions

Please see <http://www.diodes.com/package-outlines.html> for the latest version.

SOT23



SOT23			
Dim	Min	Max	Typ
A	0.37	0.51	0.40
B	1.20	1.40	1.30
C	2.30	2.50	2.40
D	0.89	1.03	0.915
F	0.45	0.60	0.535
G	1.78	2.05	1.83
H	2.80	3.00	2.90
J	0.013	0.10	0.05
K	0.890	1.00	0.975
K1	0.903	1.10	1.025
L	0.45	0.61	0.55
L1	0.25	0.55	0.40
M	0.085	0.150	0.110
a	0°	8°	--
All Dimensions in mm			

Suggested Pad Layout

Please see <http://www.diodes.com/package-outlines.html> for the latest version.

SOT23

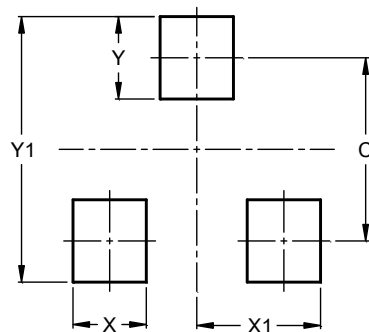

Dimensions	Value (in mm)
C	2.0
X	0.8
X1	1.35
Y	0.9
Y1	2.9

IMPORTANT NOTICE

DIODES INCORPORATED MAKES NO WARRANTY OF ANY KIND, EXPRESS OR IMPLIED, WITH REGARDS TO THIS DOCUMENT, INCLUDING, BUT NOT LIMITED TO, THE IMPLIED WARRANTIES OF MERCHANTABILITY AND FITNESS FOR A PARTICULAR PURPOSE (AND THEIR EQUIVALENTS UNDER THE LAWS OF ANY JURISDICTION).

Diodes Incorporated and its subsidiaries reserve the right to make modifications, enhancements, improvements, corrections or other changes without further notice to this document and any product described herein. Diodes Incorporated does not assume any liability arising out of the application or use of this document or any product described herein; neither does Diodes Incorporated convey any license under its patent or trademark rights, nor the rights of others. Any Customer or user of this document or products described herein in such applications shall assume all risks of such use and will agree to hold Diodes Incorporated and all the companies whose products are represented on Diodes Incorporated website, harmless against all damages.

Diodes Incorporated does not warrant or accept any liability whatsoever in respect of any products purchased through unauthorized sales channel. Should Customers purchase or use Diodes Incorporated products for any unintended or unauthorized application, Customers shall indemnify and hold Diodes Incorporated and its representatives harmless against all claims, damages, expenses, and attorney fees arising out of, directly or indirectly, any claim of personal injury or death associated with such unintended or unauthorized application.

Products described herein may be covered by one or more United States, international or foreign patents pending. Product names and markings noted herein may also be covered by one or more United States, international or foreign trademarks.

This document is written in English but may be translated into multiple languages for reference. Only the English version of this document is the final and determinative format released by Diodes Incorporated.

LIFE SUPPORT

Diodes Incorporated products are specifically not authorized for use as critical components in life support devices or systems without the express written approval of the Chief Executive Officer of Diodes Incorporated. As used herein:

A. Life support devices or systems are devices or systems which:

1. are intended to implant into the body, or
2. support or sustain life and whose failure to perform when properly used in accordance with instructions for use provided in the labeling can be reasonably expected to result in significant injury to the user.

B. A critical component is any component in a life support device or system whose failure to perform can be reasonably expected to cause the failure of the life support device or to affect its safety or effectiveness.



Customers represent that they have all necessary expertise in the safety and regulatory ramifications of their life support devices or systems, and acknowledge and agree that they are solely responsible for all legal, regulatory and safety-related requirements concerning their products and any use of Diodes Incorporated products in such safety-critical, life support devices or systems, notwithstanding any devices- or systems-related information or support that may be provided by Diodes Incorporated. Further, Customers must fully indemnify Diodes Incorporated and its representatives against any damages arising out of the use of Diodes Incorporated products in such safety-critical, life support devices or systems.

Copyright © 2017, Diodes Incorporated

www.diodes.com

Looking for pricing, stock, or lifecycle information?

Click below to explore more details on WIN SOURCE:

-  [View DDZX9V1C-7 on WIN SOURCE](#)
-  [Diodes Incorporated Information](#)

Optimize Your Supply Chain with WIN SOURCE Solutions

-  Global Sourcing Solution
-  Obsolete Management
-  Cost Control Management
-  Shortage Management
-  Alternative Solution
-  Excess Inventory Management