



THE DATASHEET OF
2238





RGB Full Color LED control IC

● (General Description)

APA102C for the three-color RGB LED dimming control string Then IC , using the CMOS process , providing three-color RGB LED output driver to adjust the output with 256 gray-scale and 32 brightness adjustment APA102 with two-output WAY ,the CLK signal by synchronization , so that the crystal cascadePiece of output movements synchronized.

● (application)

LED lamps
Large LED screen
LED billboards

● (Features)

CMOS process , low voltage, low power consumption

Synchronous of two-lane

Choose positive output or negative output RGB tri-color LED output, 8 Bit (256 level) color Set, 5Bit (32 level) brightness adjustment
Built-20mA constant current output

With self-detection signal

Built-in support for continuous oscillation PWM output can be maintained Static Screen

PRODUCT SPECIFICATIONS

Model number	Color	Millicandela	refresh rate	Applied voltage	Power consumption	View angle	weight (g)	Dimensions(mm) L x W x D	Operating temperature
SUPER LED	Full Color 16777216	R 500-650 mcd G 370-530 mcd B 120-165 mcd	400 cycle	5VDC	0.2W (MAX:1W)	H:160	0.1	5x5x1.4	-40°C~70°C

PHYSICAL DIMENSIONS

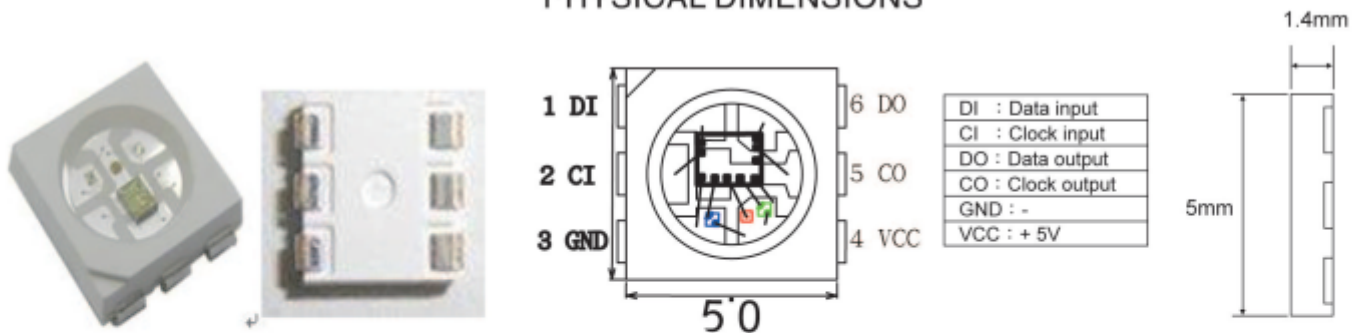



● 腳位說明 (Pin Description)

NO.	PIN NAME	I/O	FUNCTION
1	VDD	P	Power is terminal
2	VREG	O	4.5V regulator output
3	CKO	O	Series with the output clock signal
4	SDO	O	Series with the output data
5	VEN	I	Self-test function selection
6	CSEL	I	Invert the clock signal cascade
7	POLAR	I	Positive and negative output options
8	OSCI	I	Oscillator input
9	SDI	I	Series with the input data
10	CKI	I	Series with the input clock signal
11	REXT	I	Constant current source to adjust side
12	VSS	P	Power supply negative terminal
13	G	O	Green LED output
14	R	O	Red LED output
15	B	O	Blue LED output

● 功能方塊圖 (Block Diagram)

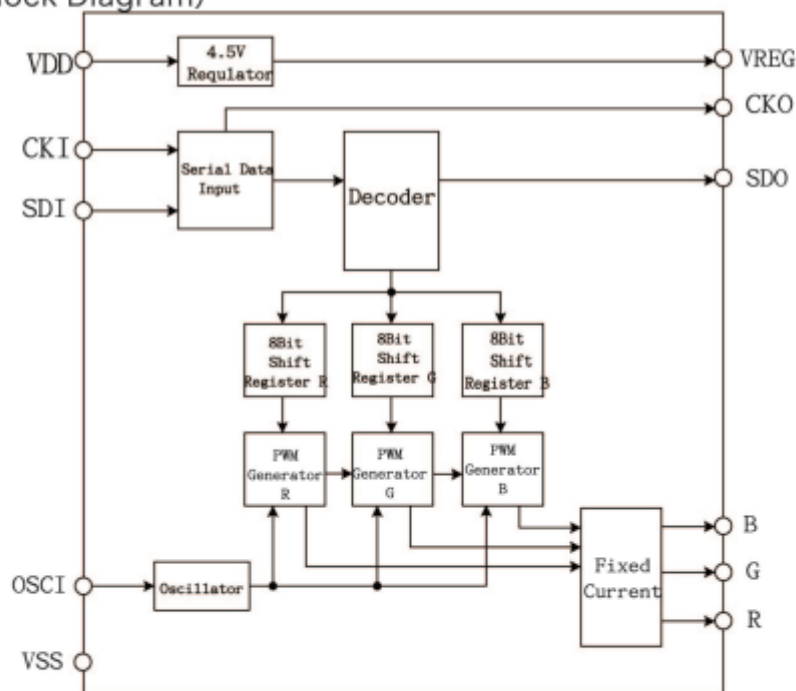



● 最大額定範圍 (Absolute Maximum Ratings)

- Supply Voltage—————-0.3V to 6.0V
- Input Voltage—————VSS-0.3 to VDD+0.3
- Operating Temperature—————-40℃ to 70 ℃
- Storage Temperature—————-50℃ to 125 ℃

Note: Stress above those listed may cause permanent damage to the devices

● 電氣特性 (Electrical Characteristics)

Symbol	Parameter	Condition	Min.	Typ.	Max	Units
VDD	Supply Voltage			5.0	5.5	V
VIH	Input High Voltage		0.7VDD		VDD+0.3	V
VH	Input Low Voltage		Vss-0.3		0.3VDD	V
LOL	Sink Current Voltage (RGB)	@VDD=5V, VOL>1V	22.5	24.5	26.5	mA
RIN	Pull High	@VDD=5V		570		KΩ
VREG	Regulator Voltage (VREG)	@VDD>5V	4.4	4.5	4.7	V
FOSC	Oscillator Frequency		800		1200	KHz

● 功能說明 (function description)

(1) .cascading data structure

Tabdem N-LED

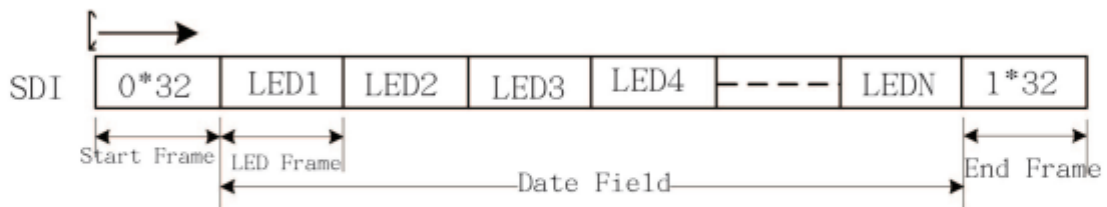

Start Frame 32 Bits

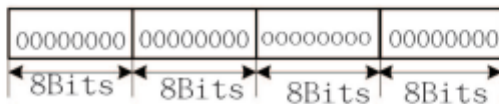

LED Frame 32 Bits



LED Frame 32 Bits





Global bit : 5-bit (32 level) brightness setting, while controlling R, G, B three-color constant current output value, if set the Global bit for the 10000 (16/31) is the output current is half again the original PWM settings.

DATA MSB↔LSB	Driving Current
00000	0/31
00001	1/31
00010	2/31
...	
11110	30/31
11111	31/31(max)

PWM input and output signals Relations

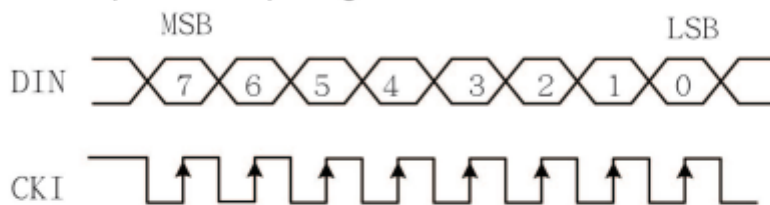

Data MSB—	Duty Cycle
00000000	0/256(min)
00000001	1/256
00000010	2/256
...	
11111101	253/256
11111110	254/256
11111111	255/256(max)

2).The number of pixels per second sent to CKI frequency (FCKI) minus the Start Frame bit divided by the number 40 the number of LED Frame bit 32, if CKI frequency (FCKI) to 512KHz, the pixel number (512000-40) /32=15998, if the 50 second update Views can be connected in series LED number 15998/50=319.To increase the number of cascaded IC CKI frequency to be increased.

(3).POLAR to empty , R, G, B for the negative output; POLAR access VSS, R, G, B is positive output.

(4).VEN: Self-detection

Data Field to the middle of 3bit were B, G, R in the MSB of the opposite phase, otherwise regarded as invalid data. VEN close to empty when the self-detection; when VEN VSS then activated self-detection.

(5).CSEL to empty when the CKO and CKI RP :CSEL connected with VSS when the CKO compared with CKI.



● 應用線路圖 (Application Circuit)

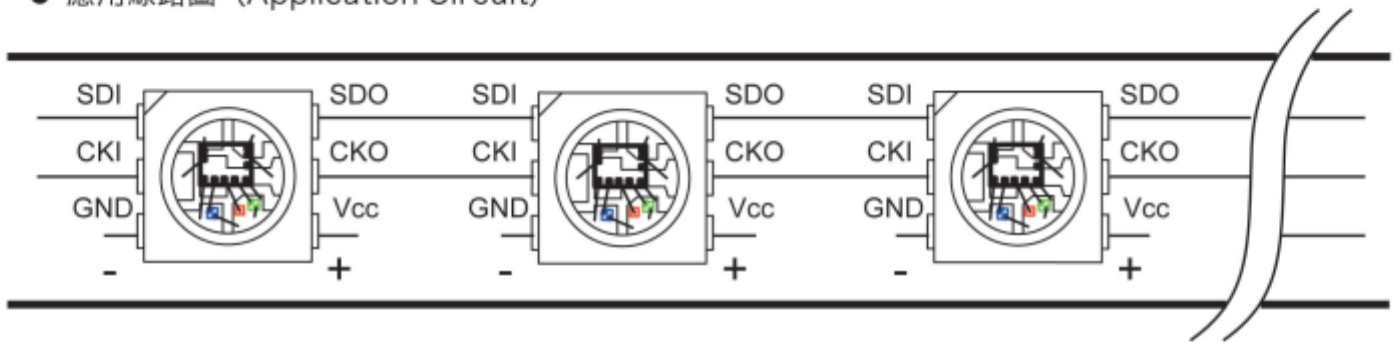

Looking for pricing, stock, or lifecycle information?

Click below to explore more details on WIN SOURCE:

-  [View 2238 on WIN SOURCE](#)
-  [Adafruit Industries LLC Information](#)

Optimize Your Supply Chain with WIN SOURCE Solutions

-  Global Sourcing Solution
-  Obsolete Management
-  Cost Control Management
-  Shortage Management
-  Alternative Solution
-  Excess Inventory Management