



**THE DATASHEET OF
LTM8029MPY**



36V_{IN}, 600mA Step-Down µModule Converter with 5µA Quiescent Current

FEATURES

- Complete Switch Mode Power Supply
- Low Quiescent Current Burst Mode® Operation
5µA I_Q at 12V_{IN} to 3.3V_{OUT}
- 600mA Output Current
- Wide Input Voltage Range: 4.5V to 36V (40V_{MAX})
- Output Voltage: 1.2V to 18V
- Excellent Dropout Performance
- Can Be Used as an Inverter
- Adjustable Switching Frequency: 200kHz to 2.2MHz
- Current Mode Control
- SnPb or RoHS Compliant Finish
- Tiny, Low Profile (11.25mm × 6.25mm × 3.42mm)
Surface Mount BGA Package

APPLICATIONS

- Automotive Battery Regulation
- Power for Portable Products
- Distributed Supply Regulation
- Industrial Supplies
- Wall Transformer Regulation

DESCRIPTION

The LTM®8029 is a 36V_{IN}, 600mA step-down µModule® converter with 5µA quiescent current. It is an adjustable frequency buck switching regulator that consumes only 5µA of quiescent current. The LTM8029 can accept an input as high as 36V_{IN} and operates at low input voltages due to its off-time skipping capability. Burst Mode operation maintains high efficiency at low output currents while keeping the output ripple low. The RUN pin features an accurate threshold and the shutdown current is 0.9µA. A power good flag signals when V_{OUT} reaches 90% of the programmed output voltage.

The LTM8029 is packaged in a thermally enhanced, compact (11.25mm × 6.25mm) and low profile (3.42mm) overmolded ball grid array (BGA) package. The LTM8029 is available with SnPb (BGA) or RoHS compliant terminal finish.

All registered trademarks and trademarks are the property of their respective owners. Protected by U.S. patents, including XXXXX, XXXXX.

TYPICAL APPLICATION

Low Quiescent Current, 5V_{OUT}, 600mA µModule Regulator

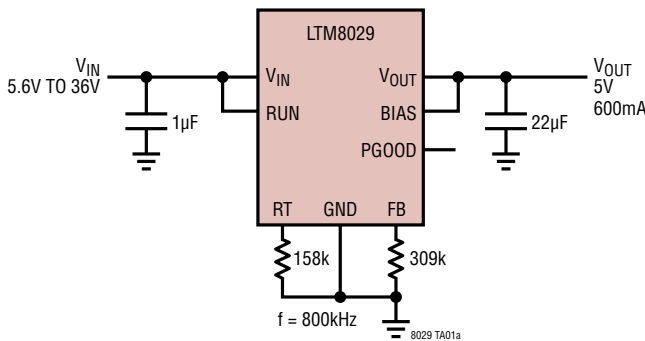

Minimum Input Voltage vs Output Current

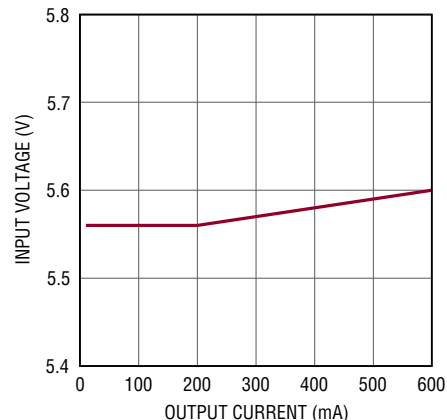

8029 TA01b

ABSOLUTE MAXIMUM RATINGS

(Notes 1, 2)

V_{IN} , RUN	40V
V_{OUT} , BIAS	20V
V_{IN} + BIAS.....	55V
PGOOD, FB, RT	6V
Internal Operating Temperature Range (Note 2)	
E and I Grades	-40°C to 125°C
MP Grade.....	-55°C to 125°C
Storage Temperature Range	-65°C to 150°C
Peak Solder Reflow Package Body Temperature...	260°C

PIN CONFIGURATION

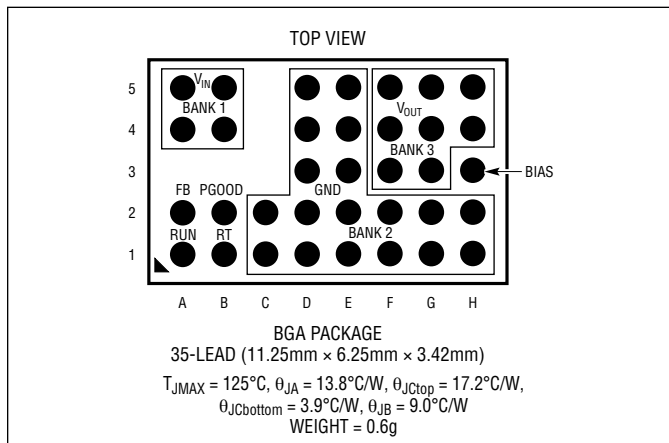

ORDER INFORMATION

PART NUMBER	PAD OR BALL FINISH	PART MARKING*		PACKAGE TYPE	MSL RATING	TEMPERATURE RANGE (Note 2)
		DEVICE	CODE			
LTM8029EY#PBF	SAC305 (RoHS)	LTM8029Y	e1	BGA	3	-40°C to 125°C
LTM8029IY#PBF	SAC305 (RoHS)	LTM8029Y	e1	BGA	3	-40°C to 125°C
LTM8029IY	SnPb (63/37)	LTM8029Y	e0	BGA	3	-40°C to 125°C
LTM8029MPY#PBF	SAC305 (RoHS)	LTM8029Y	e1	BGA	3	-55°C to 125°C
LTM8029MPY	SnPb (63/37)	LTM8029Y	e0	BGA	3	-55°C to 125°C

• Contact the factory for parts specified with wider operating temperature ranges. *Pad or ball finish code is per IPC/JEDEC J-STD-609.

- [Recommended LGA and BGA PCB Assembly and Manufacturing Procedures](#)
- [LGA and BGA Package and Tray Drawings](#)

ELECTRICAL CHARACTERISTICS

The ● denotes the specifications which apply over the full operating temperature range, otherwise specifications are at $T_A = 25^\circ\text{C}$. $V_{IN} = 12\text{V}$, $\text{RUN} = 2\text{V}$ unless otherwise noted (Note 2).

PARAMETER	CONDITIONS	MIN	TYP	MAX	UNITS
Minimum Input Voltage	●			4.5	V
Output DC Voltage	$I_{OUT} \leq 0.6\text{A}$, R_{FB} Open $I_{OUT} \leq 0.6\text{A}$, $R_{FB} = 576\text{k}$		1.2 3.3		V V
Output DC Current	$3.3V_{OUT}$	10		600	mA
Quiescent Current Into V_{IN}	$\text{RUN} = 0\text{V}$ No Load No Load		0.9 5		μA μA μA
BIAS Current	600mA Load $V_{IN} = 32\text{V}$, $V_{OUT} = 20\text{V}$ at 100mA Load		3.6 4.7		mA mA
Line Regulation	$5.5\text{V} < V_{IN} < 36\text{V}$, $I_{OUT} = 600\text{mA}$		0.3		%
Load Regulation	$10\text{mA} < I_{OUT} < 600\text{mA}$		0.4		%
Output RMS Voltage Ripple	$I_{OUT} = 600\text{mA}$		10		mV
Switching Frequency	$R_T = 41.2\text{k}$ $R_T = 124\text{k}$ $R_T = 768\text{k}$		2.2 1 200		MHz MHz kHz
Voltage at FB Pin	●	1.185 1.175	1.20 1.20	1.215 1.225	V V
Internal Feedback Resistor			1		$\text{M}\Omega$
Minimum BIAS Voltage for Proper Operation	●		1.7	2.25	V
RUN Pin Current	$\text{RUN} = 2.5\text{V}$		1	30	nA
RUN Threshold Voltage	●	0.95		1.3	V
RUN Voltage Hysteresis			30		mV
PGOOD Threshold (at FB)	V_{OUT} Rising		1.1		V
PGOOD Leakage Current	$\text{PGOOD} = 6\text{V}$		0.1	1	μA
PGOOD Sink Current	$\text{PGOOD} = 0.4\text{V}$		100		μA

Note 1: Stresses beyond those listed under Absolute Maximum Ratings may cause permanent damage to the device. Exposure to any Absolute Maximum Rating condition for extended periods may affect device reliability and lifetime.

Note 2: The LTM8029E is guaranteed to meet performance specifications from 0°C to 125°C internal. Specifications over the full -40°C to 125°C internal operating temperature range are assured by design, characterization and correlation with statistical process controls.

The LTM8029I is guaranteed to meet specifications over the full -40°C to 125°C internal operating temperature range. The LTM8029MP is guaranteed to meet specifications over the full -55°C to 125°C internal operating temperature range. Note that the maximum internal temperature is determined by specific operating conditions in conjunction with board layout, the rated package thermal resistance and other environmental factors.

TYPICAL PERFORMANCE CHARACTERISTICS

$T_A = 25^\circ\text{C}$, unless otherwise noted. Configured per Table 1, where applicable.

2.5V_{OUT} Efficiency vs Output Current, BIAS = 5V

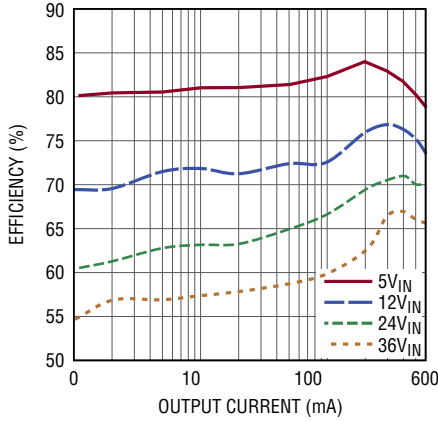

8029 G01

3.3V_{OUT} Efficiency vs Output Current, BIAS = 5V

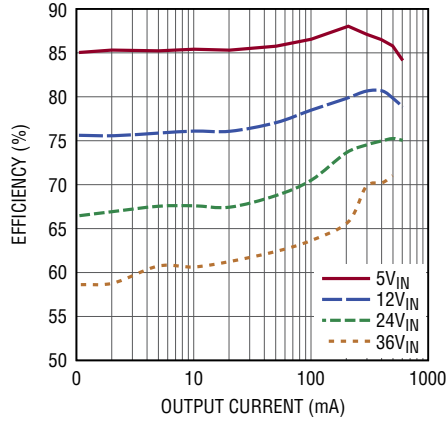

8029 G02

5V_{OUT} Efficiency vs Output Current, BIAS = 5V

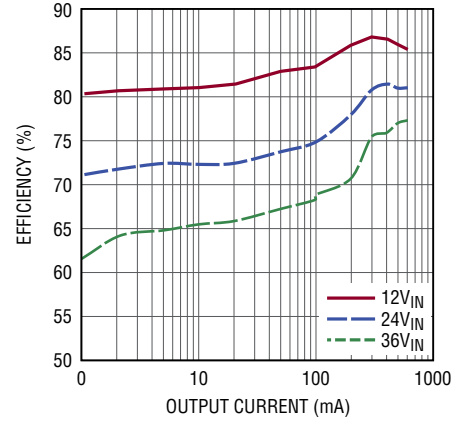

8029 G03

8V_{OUT} Efficiency vs Output Current, BIAS = 5V

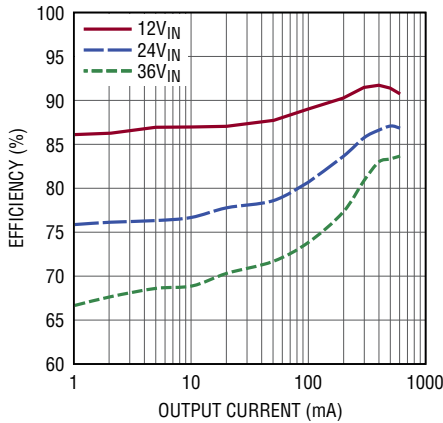

8029 G04

12V_{OUT} Efficiency vs Output Current, BIAS = 5V

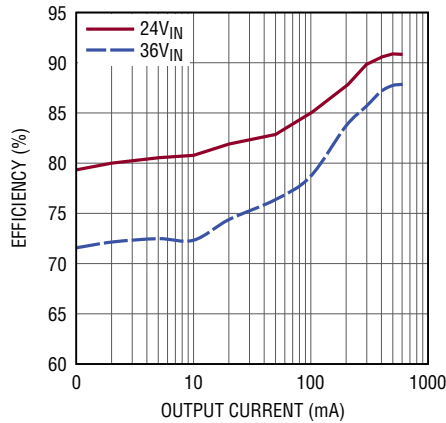

8029 G05

18V_{OUT} Efficiency vs Output Current, BIAS = 5V

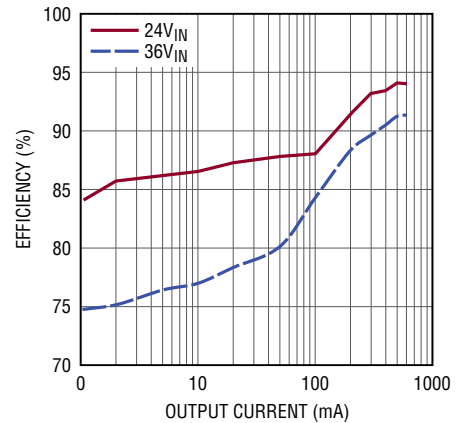

8029 G06

Input Current vs Output Current, 2.5V_{OUT}, BIAS = 5V

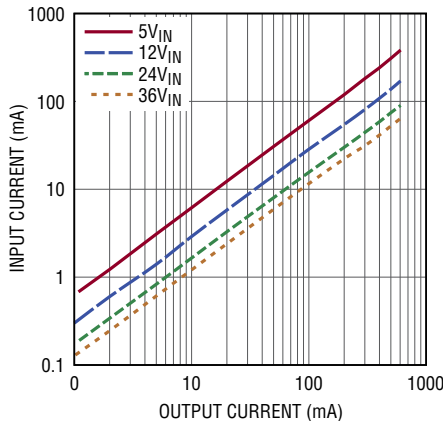

8029 G07

Input Current vs Output Current, 3.3V_{OUT}, BIAS = 5V

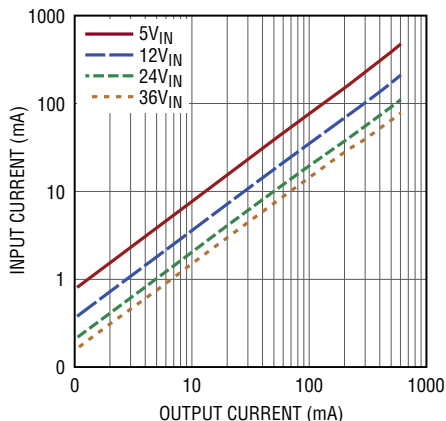

8029 G08

Input Current vs Output Current, 5V_{OUT}, BIAS = 5V

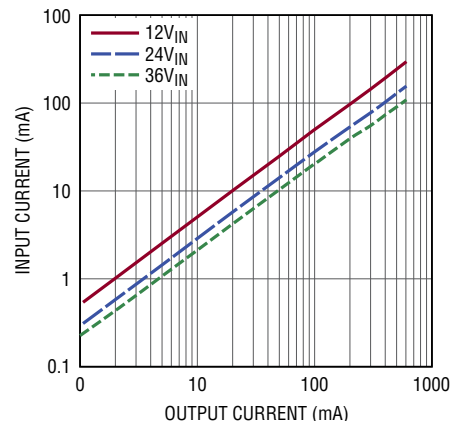

8029 G09

TYPICAL PERFORMANCE CHARACTERISTICS

$T_A = 25^\circ\text{C}$, unless otherwise noted. Configured per Table 1, where applicable.

**Input Current vs Output Current,
8V_{OUT}, BIAS = 5V**

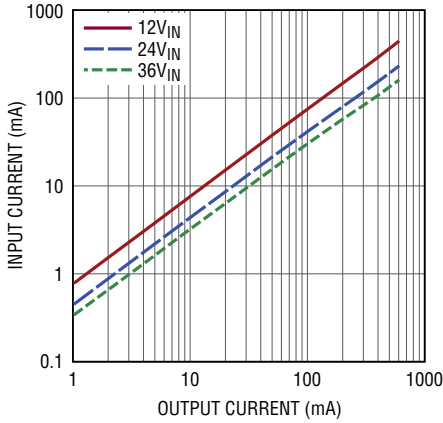

8029 G10

**Input Current vs Output Current,
12V_{OUT}, BIAS = 5V**

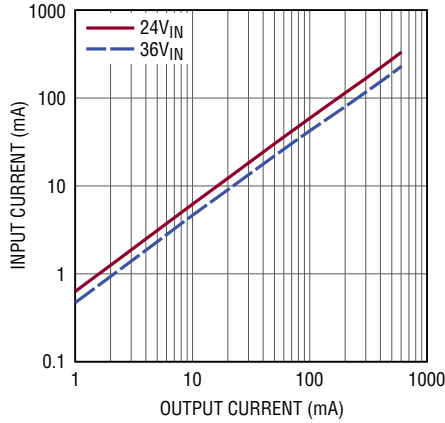

8029 G11

**Input Current vs Output Current,
18V_{OUT}, BIAS = 5V**

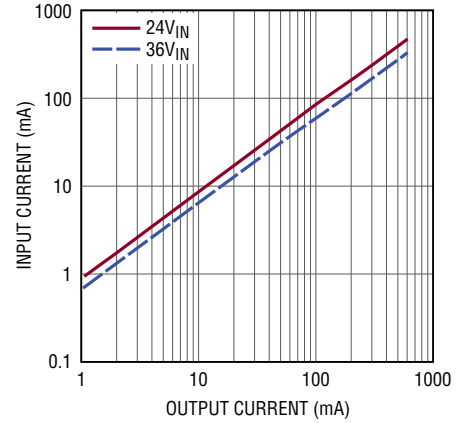

8029 G12

**Minimum V_{IN} vs V_{OUT},
I_{OUT} = 600mA, BIAS = 5V**

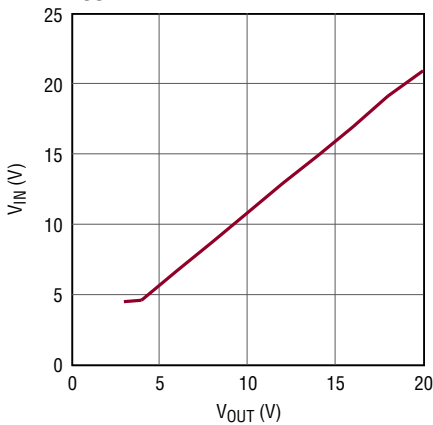

8029 G13

**Input Current vs VIN,
Output Short, BIAS = 5V**

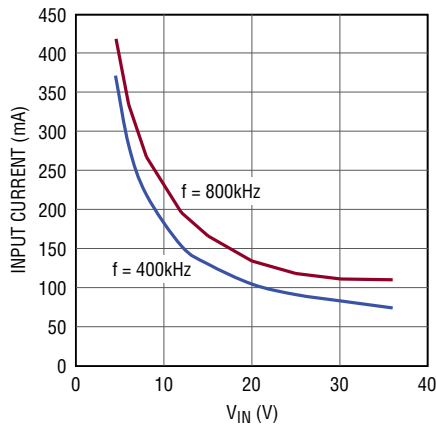

8029 G14

**Output Short-Circuit Current,
BIAS = 5V**

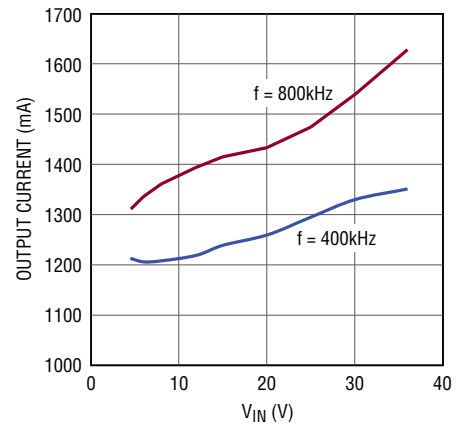

8029 G15

**I_{BIAS} vs Output Current,
2.5V_{OUT}, BIAS = 5V**

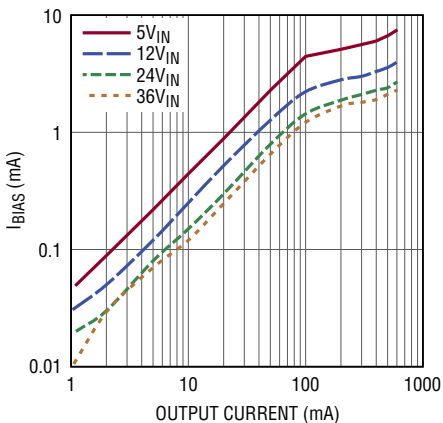

8029 G16

**I_{BIAS} vs Output Current,
3.3V_{OUT}, BIAS = 5V**

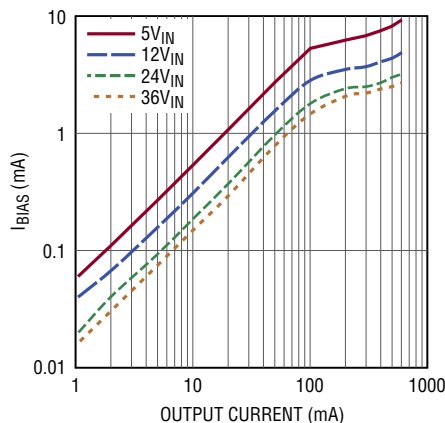

8029 G17

**I_{BIAS} vs Output Current,
5V_{OUT}, BIAS = 5V**

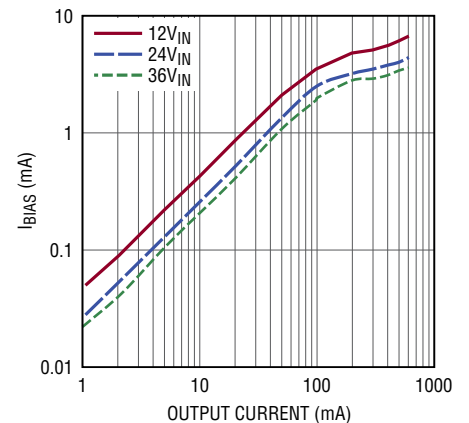

8029 G18

TYPICAL PERFORMANCE CHARACTERISTICS

$T_A = 25^\circ\text{C}$, unless otherwise noted. Configured per Table 1, where applicable.

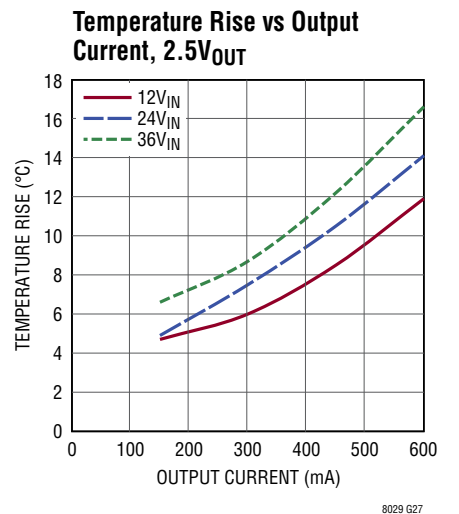
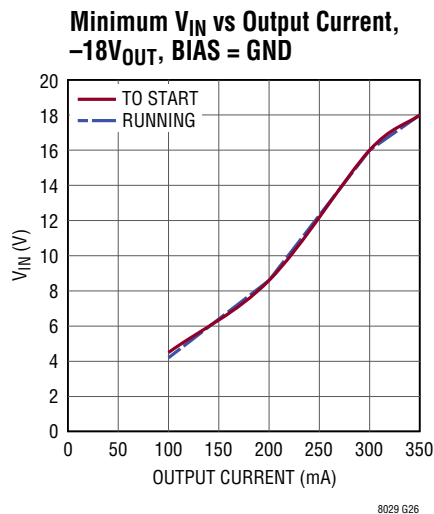
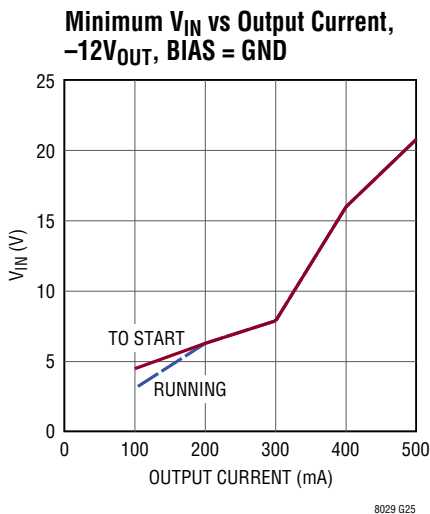
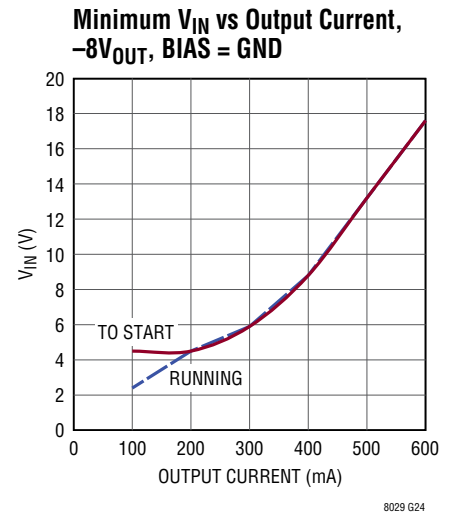
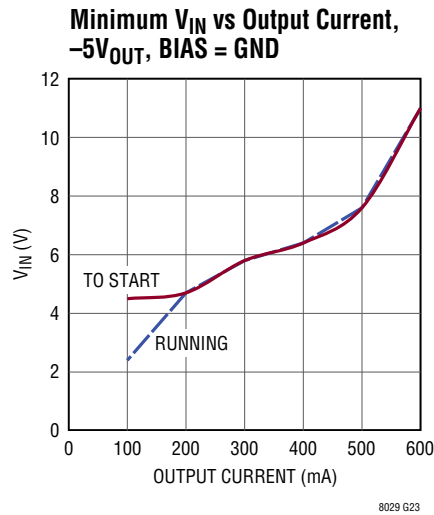
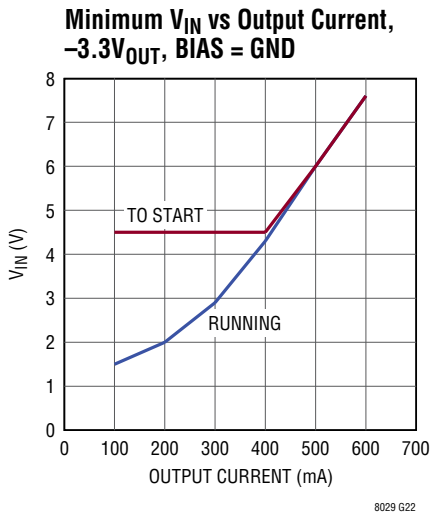
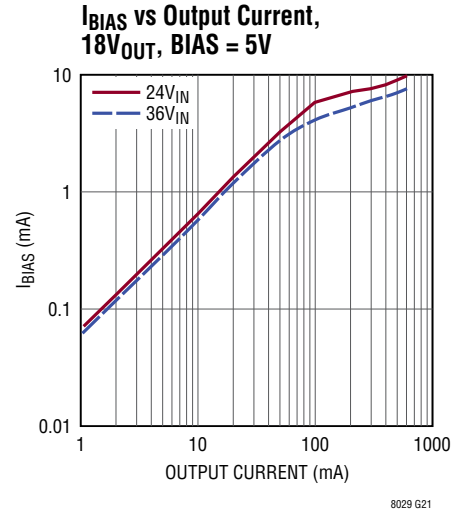
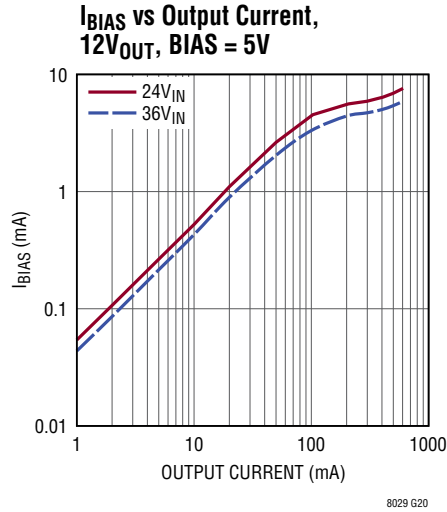
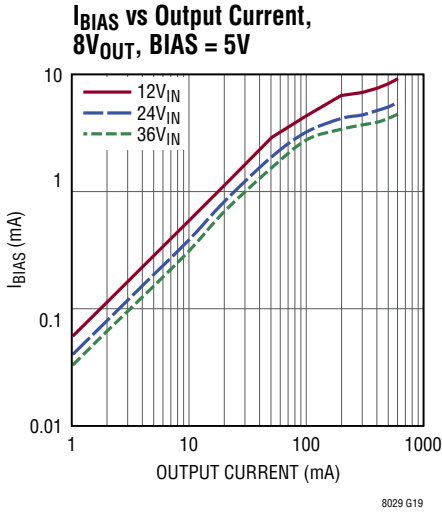

TYPICAL PERFORMANCE CHARACTERISTICS

$T_A = 25^\circ\text{C}$, unless otherwise noted. Configured per Table 1, where applicable.

Temperature Rise vs Output Current, $3.3V_{OUT}$

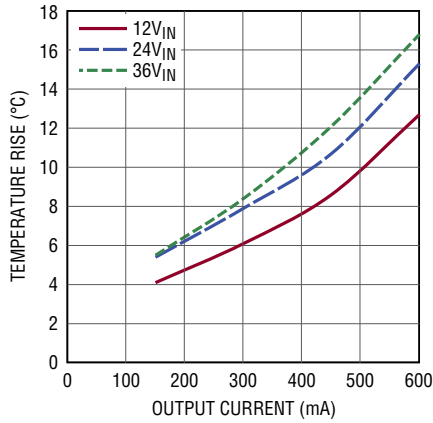

8029 G28

Temperature Rise vs Output Current, $5V_{OUT}$

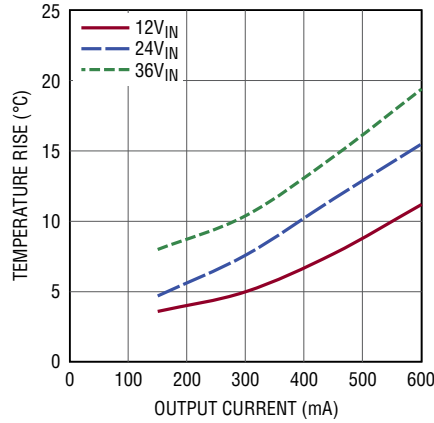

8029 G29

Temperature Rise vs Output Current, $8V_{OUT}$

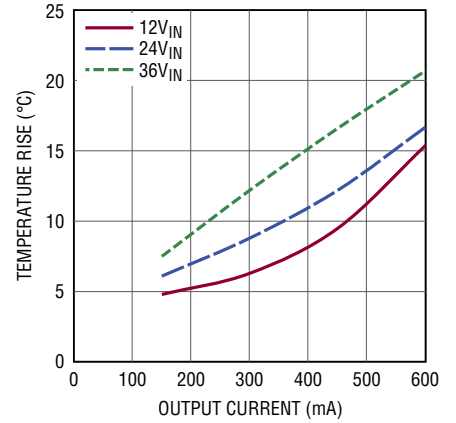

8029 G30

Temperature Rise vs Output Current, $12V_{OUT}$

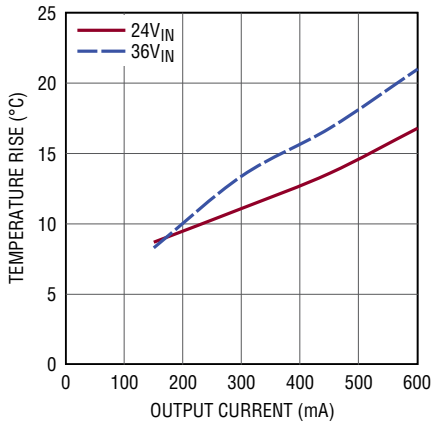

8029 G31

Temperature Rise vs Output Current, $18V_{OUT}$

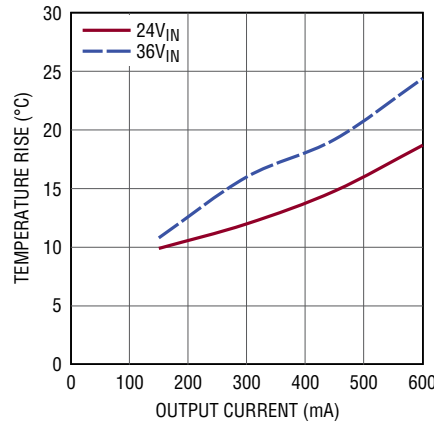

8029 G32

Temperature Rise vs Output Current, $-3.3V_{OUT}$

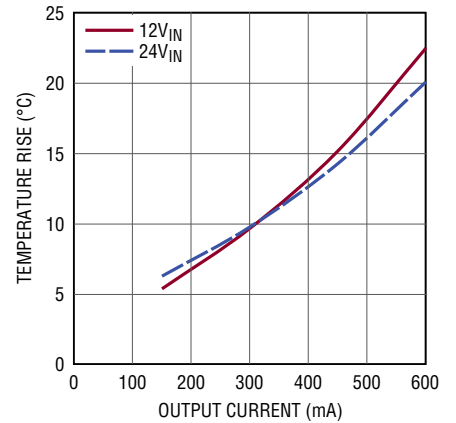

8029 G33

Temperature Rise vs Output Current, $-5V_{OUT}$

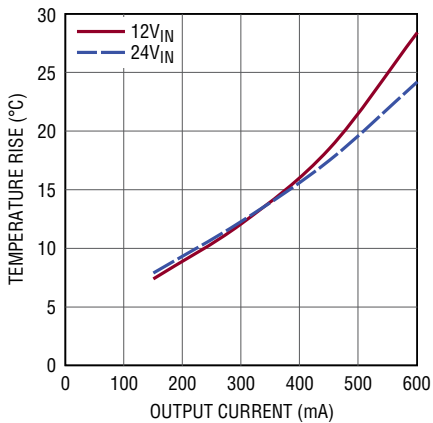

8029 G34

Temperature Rise vs Output Current, $-8V_{OUT}$

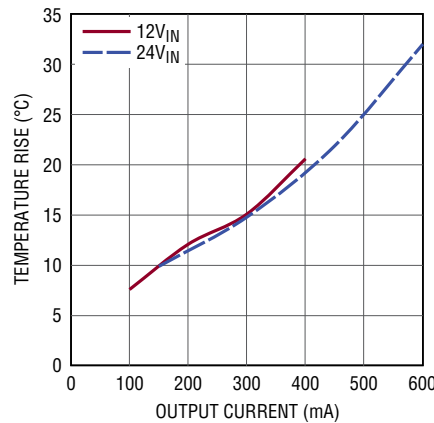

8029 G35

Temperature Rise vs Output Current, $-12V_{OUT}$

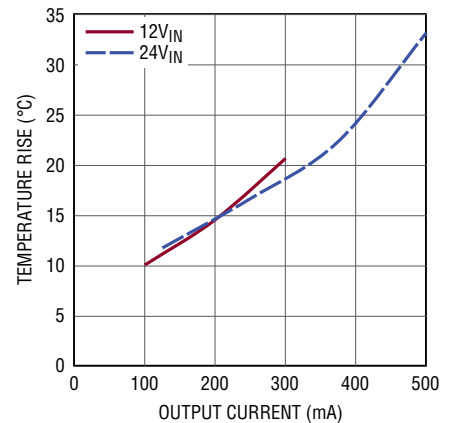

8029 G36

PIN FUNCTIONS

V_{IN} (Bank 1): The V_{IN} pins supply current to the LTM8029's internal regulator and to the internal power switch. This pin must be locally bypassed with an external, low ESR capacitor; see Table 1 for recommended values.

V_{OUT} (Bank 3): Power Output Pins. Apply the output filter capacitor and the output load between these pins and GND pins.

GND (Bank 2): Tie these GND pins to a local ground plane below the LTM8029 and the circuit components. In most applications the bulk of the heat flow out of the LTM8029 is through these pads, so the printed circuit design has a large impact on the thermal performance of the part. See the PCB Layout and Thermal Considerations sections for more details. Return the feedback resistor (R_{FB}) to this net.

RUN (Pin A1): Pull the RUN pin below 0.95V to shut down the LTM8029. Tie to 1.3V or more for normal operation. If the shutdown feature is not used, tie this pin to V_{IN}.

FB (Pin A2): The LTM8029 regulates its FB pin to 1.2V. Connect the output feedback resistor from this pin to ground. The value of R_{FB} is given by the equation $R_{FB} = 1200 / (V_{OUT} - 1.2)$, where R_{FB} is in kΩ.

RT (Pin B1): The RT pin is used to program the switching frequency of the LTM8029 by connecting a resistor from this pin to ground. The Applications Information section of the data sheet includes a table to determine the resistance value based on the desired switching frequency.

PGOOD (Pin B2): The PGOOD pin is the open-collector output of an internal comparator that monitors the FB pin. PGOOD remains low until the FB pin is within 10% of the final regulation voltage. PGOOD output is valid when V_{IN} is above 4.5V and RUN is high. If this function is not used, leave this pin floating.

BIAS (Pin H3): The BIAS pin powers internal circuitry. Connect to a power source greater than 2.25V and less than 20V. If the output is greater than 2.25V, connect this pin there. Also, make sure that BIAS + V_{IN} is less than 55V.

OPERATION

The LTM8029 is a standalone non-isolated step-down switching DC/DC power supply that can deliver up to 600mA of output current. This device features a very low quiescent current and provides a precisely regulated output voltage from 1.2V to 18V. The input voltage range is 4.5V to 36V. Given that the LTM8029 is a step-down converter, make sure that the input voltage is high enough to support the desired output voltage and load current.

As shown in the Block Diagram, the LTM8029 contains a current mode controller, power switching element, power inductor, power Schottky diode and a modest amount of input and output capacitance. The LTM8029 is a fixed frequency PWM regulator. The switching frequency is set by simply connecting the appropriate resistor value from the RT pin to GND. An internal regulator provides power to the control circuitry.

The internal regulator normally draws power from the V_{IN} pin, but if the BIAS pin is connected to an external voltage higher than 2.25V, bias power will be drawn from the external source (typically the regulated output voltage). This improves efficiency.

The RUN pin is used to place the LTM8029 in shutdown. To optimize efficiency, the LTM8029 automatically switches to Burst Mode operation in light load situations. Between bursts, all circuitry associated with controlling the output switch is shut down reducing the input supply current to

typically 5 μ A at no load and 12 V_{IN} . Since the LTM8029 is mostly shut down between bursts, the effective switching frequency will be lower than that programmed at the RT pin. For the same reason, the output ripple will be different than when the part is running at the full programmed frequency.

The LTM8029 contains a power good comparator which trips when the FB pin is at roughly 90% of its regulated value. The PGOOD output is an open-collector transistor that is off when the output is in regulation, allowing an external resistor to pull the PGOOD pin high. Power good is valid when the LTM8029 is enabled and V_{IN} is above 4.5V. The LTM8029 features the ability to skip the off-time in switching cycles when the input voltage approaches the target output. This allows the LTM8029 to operate at input voltages lower than other step-down regulators.

In an overload or short-circuit condition, the LTM8029 will protect itself by limiting its peak switching current and decreasing the operating frequency to reduce overall power consumption. The LTM8029 is also equipped with a thermal shutdown that will inhibit power switching at high junction temperatures. The activation threshold of this function, however, is above 125°C to avoid interfering with normal operation. Thus, prolonged or repetitive operation under a condition in which the thermal shutdown activates may damage or impair the reliability of the device.

APPLICATIONS INFORMATION

For most applications, the design process is straight forward, summarized as follows:

1. Look at Table 1 and find the row that has the desired input range and output voltage.
2. Apply the recommended C_{IN} , C_{OUT} , R_{FB} and R_T values.
3. Connect BIAS as indicated.

While these component combinations have been tested for proper operation, it is incumbent upon the user to verify proper operation over the intended system's line, load and environmental conditions. Bear in mind that the maximum output current is limited by junction temperature, the relationship between the input and output voltage magnitude and polarity and other factors. Please refer to the graphs in the Typical Performance Characteristics section for guidance.

The maximum frequency (and attendant R_T value) at which the LTM8029 should be allowed to switch is given in Table 1 in the f_{MAX} column, while the recommended frequency (and R_T value) for optimal efficiency over the given input condition is given in the $f_{OPTIMAL}$ column.

The LTM8029 is capable of operating at low input voltages by skipping off-times to maintain regulation. This results in a lower operating frequency than that programmed by the R_T pin, so it may be necessary to use larger input and output capacitors, depending upon the system requirements. The recommended components and V_{IN} range listed in Table 1 reflect an operation where off-times are not skipped.

Capacitor Selection Considerations

The C_{IN} and C_{OUT} capacitor values in Table 1 are the minimum recommended values for the associated operating conditions. Applying capacitor values below those indicated in Table 1 is not recommended, and may result in undesirable operation. Using larger values is generally acceptable, and can yield improved dynamic response, if it is necessary. It is incumbent upon the user to verify proper operation over the intended system's line, load and environmental conditions.

Ceramic capacitors are small, robust and have very low ESR. However, not all ceramic capacitors are suitable. X5R and X7R types are stable over temperature and applied voltage and give dependable service. Other types, including Y5V and Z5U have very large temperature and voltage coefficients of capacitance. In an application circuit they may have only a small fraction of their nominal capacitance resulting in much higher output voltage ripple than expected.

Ceramic capacitors are also piezoelectric. In Burst Mode operation, the LTM8029's switching frequency depends on the load current, and can excite a ceramic capacitor at audio frequencies, generating audible noise. Since the LTM8029 operates at a lower current limit during Burst Mode operation, the noise is typically very quiet to a casual ear. If this audible noise is unacceptable, use a high performance electrolytic capacitor at the output. It may also be a parallel combination of a ceramic capacitor and a low cost electrolytic capacitor.

A final precaution regarding ceramic capacitors concerns the maximum input voltage rating of the LTM8029. A ceramic input capacitor combined with trace or cable inductance forms a high Q (under damped) tank circuit. If the LTM8029 circuit is plugged into a live supply, the input voltage can ring to twice its nominal value, possibly exceeding the device's rating. This situation is easily avoided; see the Hot-Plugging Safety section.

APPLICATIONS INFORMATION

Table 1. Recommended Component Values and Configuration

V _{IN} (V)*	V _{OUT} (V)	C _{IN}	C _{OUT}	BIAS	R _{FB}	f _{OPT}	R _{T(OPT)}	f _{MAX}	R _{T(MIN)}
4.5-36	1.2	4.7μF 50V 1206 X5R	100μF 6.3V 1206 X5R	2.25V-20V	Open	270kHz	536k	510kHz	267k
4.5-36	1.5	4.7μF 50V 1206 X5R	100μF 6.3V 1206 X5R	2.25V-20V	4.02M	310kHz	475k	600kHz	220k
4.5-36	1.8	4.7μF 50V 1206 X5R	100μF 6.3V 1206 X5R	2.25V-20V	2M	350kHz	402k	750kHz	169k
4.5-36	2	4.7μF 50V 1206 X5R	100μF 6.3V 1206 X5R	2.25V-20V	1.5M	380kHz	374k	780kHz	162k
4.5-36	2.2	1μF 50V 1206 X5R	47μF 6.3V 1206 X5R	2.25V-20V	1.21M	450kHz	309k	840kHz	147k
4.5-36	2.5	1μF 50V 0805 X5R	47μF 6.3V 1206 X5R	2.25V-20V	931k	490kHz	280k	950kHz	127k
4.8-36	3.3	1μF 50V 0805 X5R	22μF 6.3V 1206 X5R	V _{OUT}	576k	615kHz	215k	1.2MHz	93.1k
7.8-36	5	1μF 50V 0805 X5R	22μF 6.3V 1206 X5R	V _{OUT}	309k	800kHz	158k	1.6MHz	61.9k
12-36	8	2.2μF 50V 1206 X5R	22μF 10V 1210 X5R	2.25V-20V	174k	830kHz	150k	2.2MHz	41.2k
17-36	12	2.2μF 50V 1206 X5R	10μF 50V 1210 X5R	2.25V-20V	110k	880kHz	137k	2.2MHz	41.2k
24.5-36	18	2.2μF 50V 1206 X5R	10μF 50V 1210 X5R	2.25V-20V	71.5k	880kHz	137k	2.2MHz	41.2k
10-32	-3.3	1μF 50V 0805 X5R	22μF 6.3V 1206 X5R	GND	576k	615kHz	215k	1.2MHz	93.1k
5.5-32	-3.3	4.7μF 50V 1206 X5R	100μF 6.3V 1206 X5R	GND	576k	615kHz	215k	1.2MHz	93.1k
8-31*	-5	2.2μF 50V 1206 X5R	47μF 6.3V 1206 X5R	GND	309k	800kHz	158k	1.6MHz	61.9k
7-28*	-8	2.2μF 50V 1206 X5R	22μF 10V 1210 X5R	GND	174k	830kHz	150k	2.2MHz	41.2k
7-24*	-12	2.2μF 50V 1206 X5R	22μF 16V 1210 X5R	GND	110k	880kHz	137k	2.2MHz	41.2k
4.5-24	1.2	2.2μF 50V 0805 X7R	47μF 6.3V 1206 X5R	2.25V-20V	Open	400kHz	348k	750kHz	169k
4.5-24	1.5	2.2μF 50V 0805 X7R	47μF 6.3V 1206 X5R	2.25V-20V	4.02M	430kHz	324k	930kHz	130k
4.5-24	1.8	2.2μF 50V 0805 X7R	47μF 6.3V 1206 X5R	2.25V-20V	2M	450kHz	309k	1MHz	124k
4.5-24	2	2.2μF 50V 0805 X7R	47μF 6.3V 1206 X5R	2.25V-20V	1.5M	480kHz	287k	1.2MHz	93.1k
4.5-24	2.2	1μF 50V 0805 X5R	47μF 6.3V 1206 X5R	2.25V-20V	1.21M	545kHz	249k	1.3MHz	82.5k
4.5-24	2.5	1μF 50V 0805 X5R	47μF 6.3V 1206 X5R	2.25V-20V	931k	580kHz	232k	1.4MHz	73.2k
4.8-24	3.3	1μF 25V 0603 X5R	22μF 6.3V 1206 X5R	V _{OUT}	576k	615kHz	215k	2.2MHz	41.2k
7.8-24	5	1μF 25V 0603 X5R	22μF 6.3V 1206 X5R	V _{OUT}	309k	800kHz	158k	2.2MHz	41.2k
12-24	8	2.2μF 50V 1206 X5R	22μF 10V 1210 X5R	2.25V-20V	174k	830kHz	150k	2.2MHz	41.2k
17-24	12	2.2μF 50V 1206 X5R	10μF 50V 1210 X5R	2.25V-20V	110k	880kHz	137k	2.2MHz	41.2k
9-15	1.2	2.2μF 50V 0805 X7R	47μF 6.3V 1206 X5R	2.25V-20V	Open	400kHz	348k	1.3MHz	84.5k
9-15	1.5	2.2μF 50V 0805 X7R	47μF 6.3V 1206 X5R	2.25V-20V	4.02M	430kHz	324k	1.5MHz	66.5k
9-15	1.8	2.2μF 50V 0805 X7R	47μF 6.3V 1206 X5R	2.25V-20V	2M	450kHz	309k	1.7MHz	57.6k
9-15	2	2.2μF 50V 0805 X7R	47μF 6.3V 1206 X5R	2.25V-20V	1.5M	480kHz	287k	1.9MHz	49.9k
9-15	2.2	1μF 50V 0805 X5R	47μF 6.3V 1206 X5R	2.25V-20V	1.21M	545kHz	249k	2MHz	46.4k
9-15	2.5	1μF 50V 0805 X5R	47μF 6.3V 1206 X5R	2.25V-20V	931k	580kHz	232k	2.2MHz	41.2k
9-15	3.3	1μF 25V 0603 X5R	22μF 6.3V 1206 X5R	V _{OUT}	576k	615kHz	215k	2.2MHz	41.2k
9-15	5	1μF 25V 0603 X5R	22μF 6.3V 1206 X5R	V _{OUT}	309k	800kHz	158k	2.2MHz	41.2k
12-15	8	2.2μF 50V 1206 X5R	22μF 10V 1210 X5R	2.25V-20V	174k	830kHz	150k	2.2MHz	41.2k

Notes: An input bulk capacitor is required. Do not allow V_{IN} + BIAS to exceed 55V. The minimum input operating voltage may be lower than given in the table. Refer to the Applications Information section for details.

*Maximum output current depends upon input voltage. Refer to Typical Performance Characteristics.

APPLICATIONS INFORMATION

Frequency Selection

The LTM8029 uses a constant frequency PWM architecture that can be programmed to switch from 200kHz to 2.2MHz by using a resistor tied from the RT pin to ground. Table 2 provides a list of R_T resistor values and their resultant frequencies.

Table 2. Frequency vs R_T Value

FREQUENCY (MHz)	R_T (k Ω)
0.2	768
0.4	348
0.6	220
0.8	158
1.0	124
1.2	93.1
1.4	73.2
1.6	61.9
1.8	52.3
2.0	46.4
2.2	41.2

Operating Frequency Trade-offs

It is recommended that the user apply the optimal R_T resistor value given in Table 1 for the input and output operating condition. System level or other considerations, however, may necessitate another operating frequency. While the LTM8029 is flexible enough to accommodate a wide range of operating frequencies, a haphazardly chosen one may result in undesirable operation under certain operating or fault conditions. A frequency that is too high can reduce efficiency, generate excessive heat or even damage the LTM8029 if the output is overloaded or short-circuited. A frequency that is too low can result in a final design that has too much output ripple or too large of an output capacitor. In addition, as shown in the Typical Performance Characteristics section, the operating frequency affects the amount of current that may be delivered during a short-circuit condition.

BIAS Pin Considerations

The BIAS pin is used to provide drive power for the internal power switching stage and operate other internal circuitry. For proper operation, it must be powered by at least 2.25V. If the output voltage is programmed to 2.25V or higher, BIAS may be simply tied to V_{OUT} . If V_{OUT} is less than 2.25V, BIAS can be tied to V_{IN} or some other voltage source. If the BIAS pin voltage is too high, the efficiency of the LTM8029 may suffer. The optimum BIAS voltage is dependent upon many factors, such as load current, input voltage, output voltage and switching frequency, but 4V to 5V works well in many applications. In all cases, ensure that the maximum voltage at the BIAS pin is less than 25V and that the sum of V_{IN} and BIAS is less than 55V. If BIAS power is applied from a remote or noisy voltage source, it may be necessary to apply a decoupling capacitor locally to the pin.

Burst Mode Operation

To enhance efficiency at light loads, the LTM8029 automatically switches to Burst Mode operation which keeps the output capacitor charged to the proper voltage while minimizing the input quiescent current. During Burst Mode operation, the LTM8029 delivers single cycle bursts of current to the output capacitor followed by sleep periods where the output power is delivered to the load by the output capacitor. Since the LTM8029 is mostly shut down between bursts, the effective switching frequency will be lower than that programmed at the RT pin. For the same reason, the output ripple will be different than when the part is running at the full programmed frequency. In addition, V_{IN} and BIAS quiescent currents are each greatly reduced during the sleep time. As the load current decreases towards a no load condition, the percentage of time that the LTM8029 operates in sleep mode increases and the average input current is greatly reduced, resulting in higher efficiency.

APPLICATIONS INFORMATION

RUN

The LTM8029 is in shutdown when the RUN pin is low and active when the pin is high. The rising threshold of the RUN comparator is typically 1.15V, with a 30mV hysteresis. This threshold is accurate when V_{IN} is above 4.5V. Adding a resistor divider from V_{IN} to RUN programs the LTM8029 to operate only when V_{IN} is above a desired voltage (see Figure 1). This rising threshold voltage, $V_{IN(RUN)}$, can be adjusted by setting the values R3 and R4 such that they satisfy the following equation:

$$V_{IN(RUN)} = \frac{R3 + R4}{R4} \cdot 1.15V$$

where the LTM8029 should not start until V_{IN} is above $V_{IN(RUN)}$. Note that due to the RUN pin's hysteresis, operation will not stop until the input falls slightly below $V_{IN(RUN)}$.

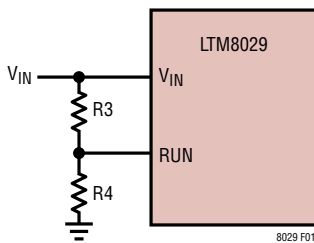

Figure 1. R3 and R4 Set the Minimum Operating Threshold Voltage

Minimum Input Voltage

The LTM8029 is a step-down converter, so a minimum amount of headroom is required to keep the output in regulation. Curves detailing the minimum input voltage of the LTM8029 for various load conditions are included in the Typical Performance Characteristics section.

The LTM8029 features the ability to skip the off-time in switching cycle when the input voltage approaches the target output. This allows the LTM8029 to operate an input voltages lower than other step-down regulators. Graphs of minimum input voltage versus output voltage and load are given in the Typical Performance Characteristics section.

It also means that the effective frequency during this mode of operation will be lower than the one programmed by the resistor connected to the RT pin, so it may be necessary to use larger input and output capacitors, depending upon the system requirements.

Shorted Input Protection

Care needs to be taken in systems where the output will be held high when the input to the LTM8029 is absent. This may occur in battery charging applications or in battery backup systems where a battery or some other supply is diode ORed with the LTM8029's output. If the V_{IN} pin is allowed to float and the RUN pin is held high (either by a logic signal or because it is tied to V_{IN}), then the LTM8029's internal circuitry will pull its quiescent current through its internal power switch. This is fine if your system can tolerate a few milliamps in this state. If you ground the RUN pin, the input current will drop to essentially zero. However, if the V_{IN} pin is grounded while the output is held high, then parasitic diodes inside the LTM8029 can pull large currents from the output through the V_{IN} pin. Figure 2 shows a circuit that will run only when the input voltage is present and that protects against a shorted or reversed input.

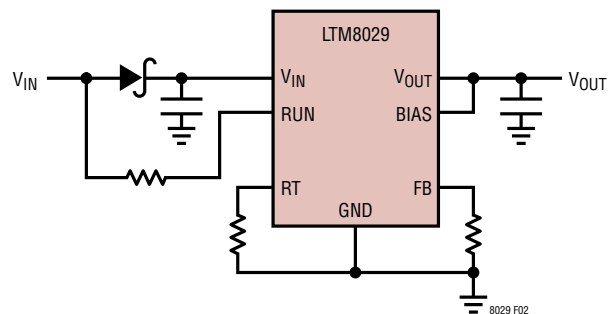

Figure 2. The Input Diode Prevents Shorted Input from Discharging a Backup Battery Tied to the Output. It Also Protects the Circuit from a Reversed Input. The LTM8029 Runs Only When the Input is Present

APPLICATIONS INFORMATION

Power Good

The PGOOD pin is the open-collector output of an internal comparator that monitors the voltage at the FB pin. It is used to indicate whether the output is near or within regulation. Specifically, PGOOD is low unless the FB pin is within 10% of the final regulation voltage. PGOOD output is valid when V_{IN} is above 4.5V and RUN is high. If this function is not used, leave this pin floating.

Hot-Plugging Safely

The small size, robustness and low impedance of ceramic capacitors make them an attractive option for the input bypass capacitor of LTM8029. However, these capacitors can cause problems if the LTM8029 is hot-plugged into a live supply (see Application Note 88 for a complete discussion). The low loss ceramic capacitor combined with stray inductance in series with the power source forms an underdamped tank circuit, and the voltage at the V_{IN} pin of the LTM8029 can ring to more than twice the nominal input voltage, possibly exceeding the LTM8029's rating and damaging the part. If the input supply is poorly controlled or the user will be hot-plugging the LTM8029 into an energized supply, the input network should be designed to prevent this overshoot. This can be accomplished by installing a small resistor in series to V_{IN} , but the most popular method of controlling input voltage overshoot is to add an electrolytic bulk capacitor to the V_{IN} net. This capacitor's relatively high equivalent series resistance usually damps the circuit and eliminates the voltage overshoot. The extra capacitor improves low frequency ripple filtering and can slightly improve the efficiency of the circuit, though it is likely to be the largest component in the circuit.

PCB Layout

Most of the headaches associated with PCB layout have been alleviated or even eliminated by the high level of integration of the LTM8029. The LTM8029 is nevertheless a switching power supply, and care must be taken to minimize EMI and ensure proper operation. Even with the high level of integration, you may fail to achieve specified operation with a haphazard or poor layout. See Figure 3 for a suggested layout. Ensure that the grounding and heat sinking are acceptable.

1. Place the R_{FB} and R_T resistors as close as possible to their respective pins.
2. Place the C_{IN} capacitor as close as possible to the V_{IN} and GND connection of the LTM8029.
3. Place the C_{OUT} capacitor as close as possible to the V_{OUT} and GND connection of the LTM8029.
4. Place the C_{IN} and C_{OUT} capacitors such that their ground currents flow directly adjacent or underneath the LTM8029.
5. Connect all of the GND connections to as large a copper pour or plane area as possible on the top layer. Avoid breaking the ground connection between the external components and the LTM8029.
6. For good heat sinking, use vias to connect the GND copper area to the board's internal ground planes. Liberally distribute these GND vias to provide both a good ground connection and thermal path to the internal planes of the printed circuit board. Pay attention to the location and density of the thermal vias in Figure 3. The LTM8029 can benefit from the heat sinking afforded by vias that connect to internal GND planes at these locations, due to their proximity to internal power handling components. The optimum number of thermal vias depends upon the printed circuit board design. For example, a board might use very small via holes. It should employ more thermal vias than a board that uses larger holes.

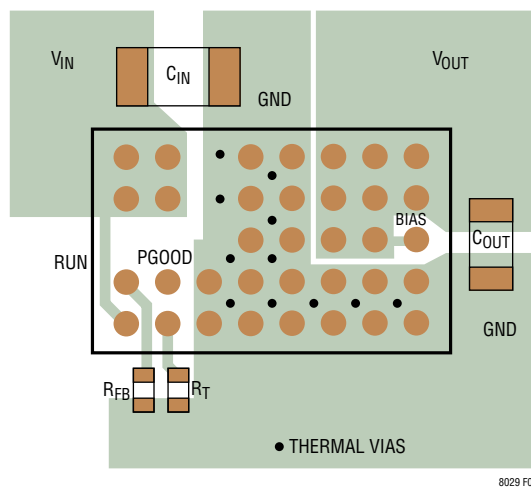

Figure 3. Layout Showing Suggested External Components, GND Plane and Thermal ViAs

APPLICATIONS INFORMATION

Thermal Considerations

The LTM8029 output current may need to be derated if it is required to operate in a high ambient temperature or deliver a large amount of continuous power. The amount of current derating is dependent upon the input voltage, output power and ambient temperature. The temperature rise curves given in the Typical Performance Characteristics section can be used as a guide. These curves were generated by a LTM8029 mounted to a 40cm² 4-layer FR4 printed circuit board. Boards of other sizes and layer count can exhibit different thermal behavior, so it is incumbent upon the user to verify proper operation over the intended system's line, load and environmental operating conditions.

The thermal resistance numbers listed in the Pin Configuration are based on modeling the μ Module package mounted on a test board specified per JESD 51-9 ("Test Boards for Area Array Surface Mount Package Thermal Measurements"). The thermal coefficients provided in this page are based on JESD 51-12 ("Guidelines for Reporting and Using Electronic Package Thermal Information").

For increased accuracy and fidelity to the actual application, many designers use FEA to predict thermal performance. To that end, the Pin Configuration section typically gives four thermal coefficients:

- θ_{JA} – Thermal resistance from junction to ambient
- $\theta_{JCbottom}$ – Thermal resistance from junction to the bottom of the product case
- θ_{JCtop} – Thermal resistance from junction to top of the product case
- θ_{JB} – Thermal resistance from junction to the printed circuit board

While the meaning of each of these coefficients may seem to be intuitive, JEDEC has defined each to avoid confusion and inconsistency. These definitions are given in JESD 51-12, and are quoted or paraphrased below:

- θ_{JA} is the natural convection junction-to-ambient air thermal resistance measured in a one cubic foot sealed enclosure. This environment is sometimes referred to as "still air" although natural convection causes the air to move. This value is determined with the part mounted to a JESD 51-9 defined test board, which does not reflect an actual application or viable operating condition.
- $\theta_{JCbottom}$ is the thermal resistance between the junction and bottom of the package with all of the component power dissipation flowing through the bottom of the package. In the typical μ Module converter, the bulk of the heat flows out the bottom of the package, but there is always heat flow out into the ambient environment. As a result, this thermal resistance value may be useful for comparing packages but the test conditions don't generally match the user's application.
- θ_{JCtop} is determined with nearly all of the component power dissipation flowing through the top of the package. As the electrical connections of the typical μ Module converter are on the bottom of the package, it is rare for an application to operate such that most of the heat flows from the junction to the top of the part. As in the case of $\theta_{JCbottom}$, this value may be useful for comparing packages but the test conditions don't generally match the user's application.
- θ_{JB} is the junction-to-board thermal resistance where almost all of the heat flows through the bottom of the μ Module converter and into the board, and is really the sum of the $\theta_{JCbottom}$ and the thermal resistance of the bottom of the part through the solder joints and through a portion of the board. The board temperature is measured a specified distance from the package, using a two sided, two layer board. This board is described in JESD 51-9.

APPLICATIONS INFORMATION

Given these definitions, it should now be apparent that none of these thermal coefficients reflects an actual physical operating condition of a μ Module converter. Thus, none of them can be individually used to accurately predict the thermal performance of the product. Likewise, it would be inappropriate to attempt to use any one coefficient to correlate to the junction temperature vs load graphs given in the product's data sheet. The only appropriate way to use the coefficients is when running a detailed thermal analysis, such as FEA, which considers all of the thermal resistances simultaneously.

A graphical representation of these thermal resistances is given in Figure 4.

The blue resistances are contained within the μ Module converter, and the green are outside.

The die temperature of the LTM8029 must be lower than the maximum rating of 125°C, so care should be taken in the layout of the circuit to ensure good heat sinking of the LTM8029. The bulk of the heat flow out of the LTM8029 is through the bottom of the μ Module converter and the BGA pads into the printed circuit board. Consequently a poor printed circuit board design can cause excessive heating, resulting in impaired performance or reliability. Please refer to the PCB Layout section for printed circuit board design suggestions.

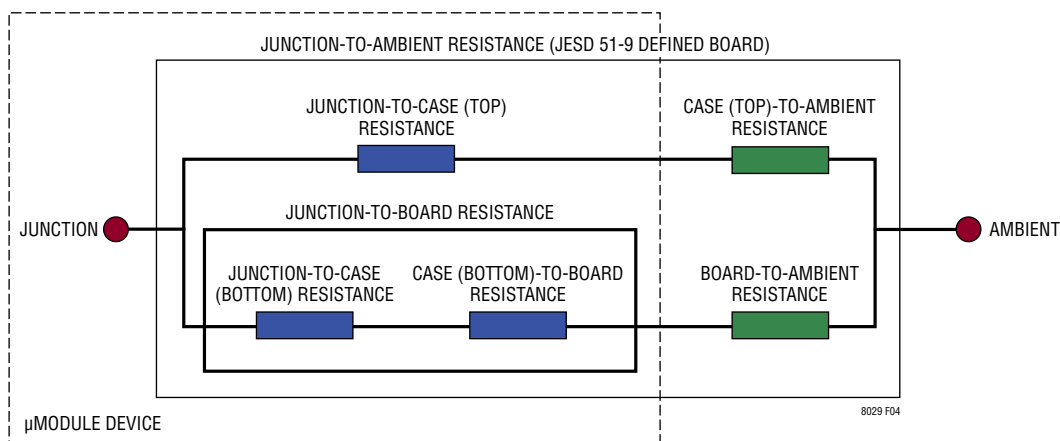
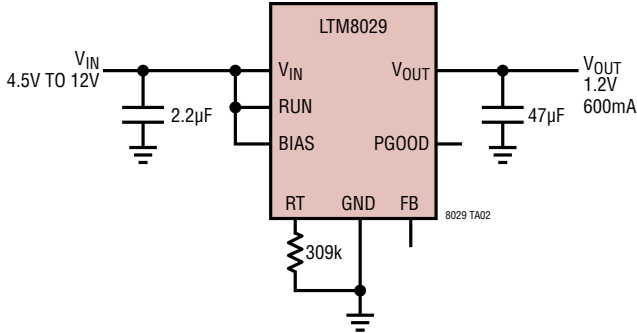

Figure 4. Graphical Representation of JESD 51-12 Thermal Coefficients

TYPICAL APPLICATION

1.2V Step-Down Converter



2.5V Step-Down Converter

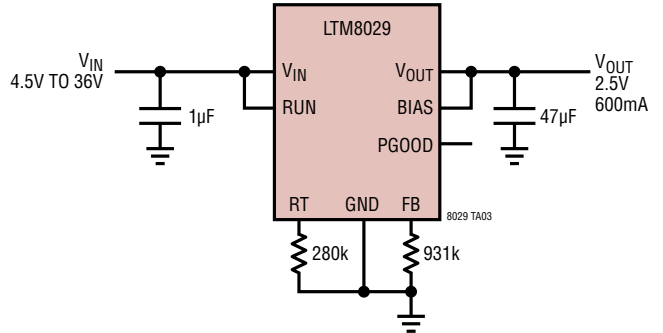

5V Step-Down Converter

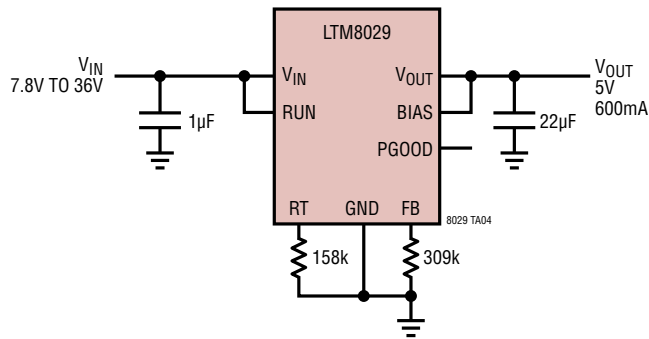

-5V Inverting Output Converter

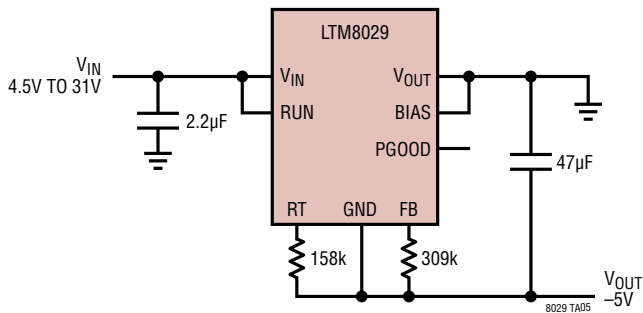

Minimum VIN vs Output Current

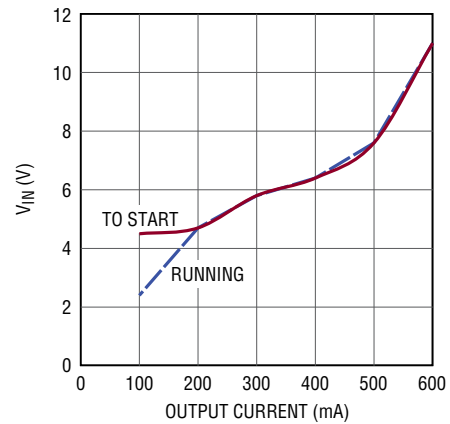

8029 TA06

TYPICAL APPLICATION

-12V Inverting Output Converter

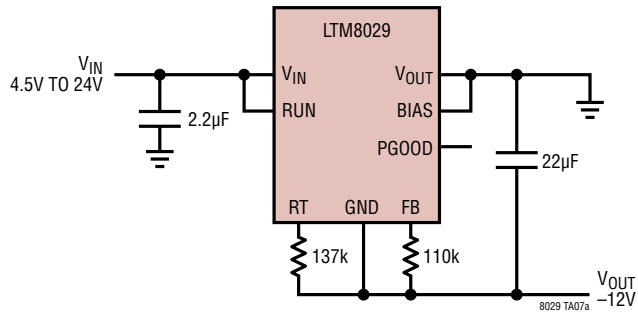

Minimum V_{IN} vs Output Current,
-12V $_{OUT}$, BIAS = GND



PACKAGE DESCRIPTION

Table 3. Pin Assignment Table (Arranged by Pin Number)

PIN	FUNCTION	PIN	FUNCTION	PIN	FUNCTION	PIN	FUNCTION
A1	RUN	B1	RT	C1	GND	D1	GND
A2	FB	B2	PGOOD	C2	GND	D2	GND
A3	-	B3	-	C3	-	D3	GND
A4	V_{IN}	B4	V_{IN}	C4	-	D4	GND
A5	V_{IN}	B5	V_{IN}	C5	-	D5	GND

PIN	FUNCTION	PIN	FUNCTION	PIN	FUNCTION	PIN	FUNCTION
E1	GND	F1	GND	G1	GND	H1	GND
E2	GND	F2	GND	G2	GND	H2	GND
E3	GND	F3	V_{OUT}	G3	V_{OUT}	H3	BIAS
E4	GND	F4	V_{OUT}	G4	V_{OUT}	H4	V_{OUT}
E5	GND	F5	V_{OUT}	G5	V_{OUT}	H5	V_{OUT}

PACKAGE DESCRIPTION

BGA Package
35-Lead (11.25mm × 6.25mm × 3.42mm)
 (Reference LTC DWG # 05-08-1878 Rev 0)

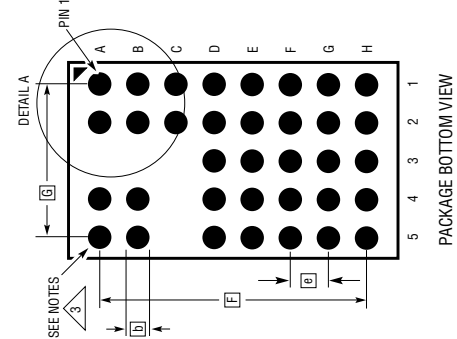

PACKAGE BOTTOM VIEW

- NOTES:
1. DIMENSIONING AND TOLERANCING PER ASME Y14.5M-1994
 2. ALL DIMENSIONS ARE IN MILLIMETERS
 3. BALL DESIGNATION PER JEDEC MS-028 AND JEP95
 4. DETAILS OF PIN #1 IDENTIFIER ARE OPTIONAL, BUT MUST BE LOCATED WITHIN THE ZONE INDICATED. THE PIN #1 IDENTIFIER MAY BE EITHER A MOLD OR MARKED FEATURE
 5. PRIMARY DATUM -Z- IS SEATING PLANE

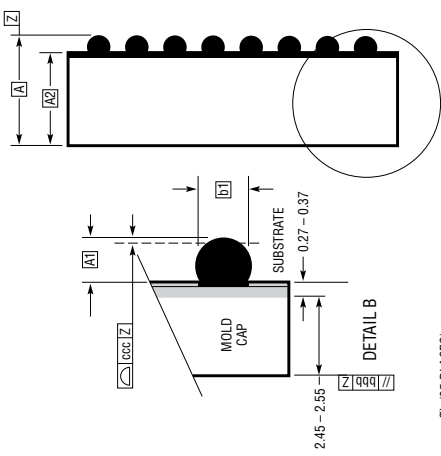
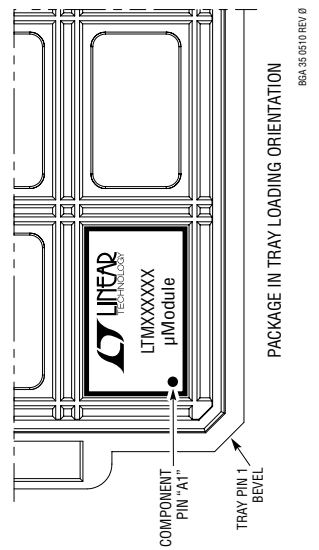

DETAIL B PACKAGE SIDE VIEW

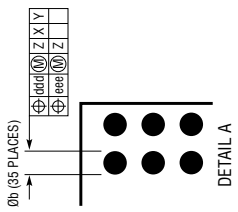

DETAIL A

DIMENSIONS				
SYMBOL	MIN	NOM	MAX	NOTES
A	3.22	3.42	3.62	
A1	0.50	0.60	0.70	
A2	2.72	2.82	2.92	
b	0.71	0.78	0.85	
b1	0.60	0.63	0.66	
D		11.25		
E		6.25		
e		1.27		
F		8.89		
G		5.08		
aaa			0.15	
bbb			0.10	
ccc			0.20	
ddd			0.30	
eee			0.15	
				TOTAL NUMBER OF BALLS: 35

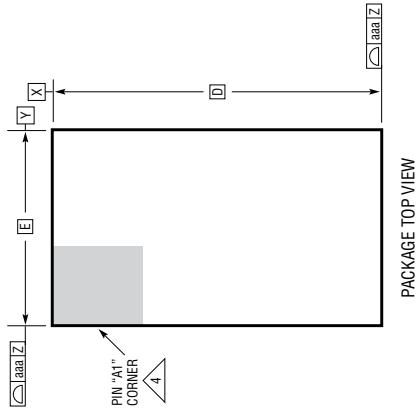

PACKAGE TOP VIEW

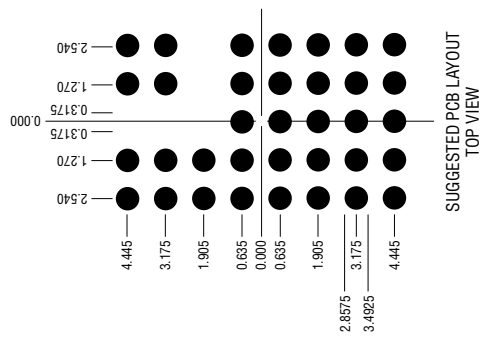

SUGGESTED PCB LAYOUT TOP VIEW

REVISION HISTORY (Revision history begins at Rev B)

REV	DATE	DESCRIPTION	PAGE NUMBER
B	02/13	Table 1, changed Bias voltage from 2.1V to 2.25V	11
		Table 1, changed V_{IN} 10-33 and 5.5V-33 to 10-32 and 5.5-32, respectively	11
		Updated all graphs	4
C	02/14	Added SnPb BGA package option	1, 2
D	10/16	Added web link to Order Information	2
		Updated Temperature Rise vs Output Current graph for $-5V_{OUT}$, $-8V_{OUT}$ and $-12V_{OUT}$	7
		Table 1, changed V_{IN} 18-24 to 4.8-24	12
		Typical Application for $-12V$ Inverting Output Convertor, changed Maximum V_{IN} 31V to 24V	22
E	04/19	Added Storage Temperature Range -65°C to 150°C	2
		Changed Maximum Internal Temperature 125°C to Internal Operating Temperature Range (Note 2)	
		E and I Grades -40°C to 125°C	
		MP Grade -55°C to 125°C	
		Changed Solder Temperature 260°C to Peak Solder Reflow Package Body Temperature	

PACKAGE PHOTO

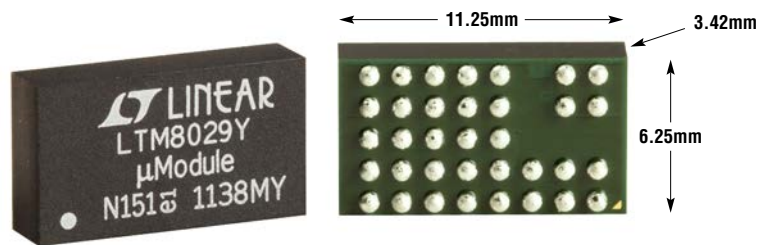

DESIGN RESOURCES



SUBJECT	DESCRIPTION
μModule Design and Manufacturing Resources	<p>Design:</p> <ul style="list-style-type: none"> • Selector Guides • Demo Boards and Gerber Files • Free Simulation Tools <p>Manufacturing:</p> <ul style="list-style-type: none"> • Quick Start Guide • PCB Design, Assembly and Manufacturing Guidelines • Package and Board Level Reliability
μModule Regulator Products Search	<ol style="list-style-type: none"> 1. Sort table of products by parameters and download the result as a spread sheet. 2. Search using the Quick Power Search parametric table.
Digital Power System Management	<p>Analog Devices' family of digital power supply management ICs are highly integrated solutions that offer essential functions, including power supply monitoring, supervision, margining and sequencing, and feature EEPROM for storing user configurations and fault logging.</p>

RELATED PARTS

PART NUMBER	DESCRIPTION	COMMENTS
LTM8020	36V, 200mA μModule Regulator	$4V \leq V_{IN} \leq 36V$, $1.25V \leq V_{OUT} \leq 5V$
LTM8021	36V, 500mA μModule Regulator	$3V \leq V_{IN} \leq 36V$, $0.8V \leq V_{OUT} \leq 5V$
LTM8022	36V, 1A μModule Regulator	$3.6V \leq V_{IN} \leq 36V$, $0.8V \leq V_{OUT} \leq 10V$
LTM8023	36V, 2A μModule Regulator	$3.6V \leq V_{IN} \leq 36V$, $0.8V \leq V_{OUT} \leq 10V$
LTM8048	Isolated μModule Regulator	725V _{DC} Isolation, $3.1V \leq V_{IN} \leq 32V$, 300mA

Looking for pricing, stock, or lifecycle information?

Click below to explore more details on WIN SOURCE:

-  [View LTM8029MPY on WIN SOURCE](#)
-  [Analog Devices Inc. Information](#)

Optimize Your Supply Chain with WIN SOURCE Solutions

-  Global Sourcing Solution
-  Obsolete Management
-  Cost Control Management
-  Shortage Management
-  Alternative Solution
-  Excess Inventory Management