

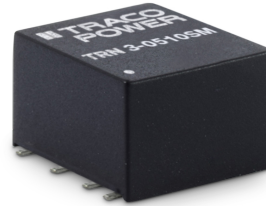

**THE DATASHEET OF
TRN 3-4812SM**



- Compact SMD package
11,9 x 11,3 x 8,0 mm
- Fully regulated outputs
- Input Voltage range
4.5-13.2, 9-18, 18-36, 36-75 VDC
- I/O-isolation 1'600 VDC
- Operating temperature range
-40°C to +85°C
- Short circuit protection
- Designed to meet IEC/EN/UL 62368-1
(not certified)
- 3-year product warranty



The TRN 3SM Series comprises 3 Watt fully regulated, high performance DC/DC converters. They come in a compact cubical package of only 1.07 cm³. Full load operation is reliable up to 65°C environment temperature. With 1'600 VDC I/O-isolation voltage, and short current protection they cover a wide range of application when space is limited. The input of the converters is designed for a wide voltage range (2:1) and minimum load is not required. The functional I/O-isolation system is designed to meet IEC/EN/UL 62368-1 (not certified) with a test voltage (60 s) of 1600 VDC.

Models

Order Code	Input Voltage Range	Output 1		Output 2		Efficiency typ.
		Vnom	I _{max}	Vnom	I _{max}	
TRN 3-0510SM	4.5 - 13.2 VDC (9 VDC nom.)	3.3 VDC	700 mA			75 %
TRN 3-0511SM		5 VDC	600 mA			78 %
TRN 3-0512SM		12 VDC	250 mA			82 %
TRN 3-0513SM		15 VDC	200 mA			80 %
TRN 3-0515SM		24 VDC	125 mA			80 %
TRN 3-0521SM		+5 VDC	300 mA	-5 VDC	300 mA	77 %
TRN 3-0522SM		+12 VDC	125 mA	-12 VDC	125 mA	80 %
TRN 3-0523SM		+15 VDC	100 mA	-15 VDC	100 mA	80 %
TRN 3-1210SM	9 - 18 VDC (12 VDC nom.)	3.3 VDC	700 mA			76 %
TRN 3-1211SM		5 VDC	600 mA			79 %
TRN 3-1212SM		12 VDC	250 mA			84 %
TRN 3-1213SM		15 VDC	200 mA			83 %
TRN 3-1215SM		24 VDC	125 mA			82 %
TRN 3-1221SM		+5 VDC	300 mA	-5 VDC	300 mA	78 %
TRN 3-1222SM		+12 VDC	125 mA	-12 VDC	125 mA	82 %
TRN 3-1223SM		+15 VDC	100 mA	-15 VDC	100 mA	81 %
TRN 3-2410SM	18 - 36 VDC (24 VDC nom.)	3.3 VDC	700 mA			76 %
TRN 3-2411SM		5 VDC	600 mA			78 %
TRN 3-2412SM		12 VDC	250 mA			84 %
TRN 3-2413SM		15 VDC	200 mA			84 %
TRN 3-2415SM		24 VDC	125 mA			83 %
TRN 3-2421SM		+5 VDC	300 mA	-5 VDC	300 mA	79 %
TRN 3-2422SM		+12 VDC	125 mA	-12 VDC	125 mA	83 %
TRN 3-2423SM		+15 VDC	100 mA	-15 VDC	100 mA	82 %
TRN 3-4810SM	36 - 75 VDC (48 VDC nom.)	3.3 VDC	700 mA			75 %
TRN 3-4811SM		5 VDC	600 mA			79 %
TRN 3-4812SM		12 VDC	250 mA			83 %
TRN 3-4813SM		15 VDC	200 mA			83 %
TRN 3-4815SM		24 VDC	125 mA			82 %
TRN 3-4821SM		+5 VDC	300 mA	-5 VDC	300 mA	77 %
TRN 3-4822SM		+12 VDC	125 mA	-12 VDC	125 mA	82 %
TRN 3-4823SM		+15 VDC	100 mA	-15 VDC	100 mA	80 %

Input Specifications

Input Current	- At no load	9 Vin models: 75 mA typ. 12 Vin models: 40 mA typ. 24 Vin models: 20 mA typ. 48 Vin models: 12 mA typ.
Surge Voltage		9 Vin models: 15 VDC max. (1 s max.) 12 Vin models: 25 VDC max. (1 s max.) 24 Vin models: 50 VDC max. (1 s max.) 48 Vin models: 100 VDC max. (1 s max.)
Reflected Ripple Current		9 Vin models: 100 mA_{p-p} typ. 12 Vin models: 75 mA_{p-p} typ. 24 Vin models: 75 mA_{p-p} typ. 48 Vin models: 50 mA_{p-p} typ.
Recommended Input Fuse		9 Vin models: 1'600 mA (slow blow) 12 Vin models: 800 mA (slow blow) 24 Vin models: 500 mA (slow blow) 48 Vin models: 315 mA (slow blow) (The need of an external fuse has to be assessed in the final application.)
Input Filter		Internal Capacitor

Output Specifications

Voltage Set Accuracy		±1% max.
Regulation	- Input Variation (V _{min} - V _{max})	single output models: 0.2% max. dual output models: 0.2% max.
	- Load Variation (0 - 100%)	single output models: 1% max. dual output models: 1% max. (Output 1) 1% max. (Output 2)
	- Cross Regulation (25% / 100% asym. load)	dual output models: 5% max.
Ripple and Noise	- 20 MHz Bandwidth	50 mV_{p-p} typ.
Capacitive Load	- single output	3.3 V _{out} models: 4'400 μF max. 5 V _{out} models: 2'200 μF max. 12 V _{out} models: 1'000 μF max. 15 V _{out} models: 820 μF max. 24 V _{out} models: 330 μF max.
	- dual output	5 / -5 V _{out} models: 1'200 / 1'200 μF max. 12 / -12 V _{out} models: 520 / 520 μF max. 15 / -15 V _{out} models: 440 / 440 μF max.
Minimum Load		Not required
Temperature Coefficient		±0.02 %/K max.
Start-up Time		5 ms typ. / 15 ms max.
Short Circuit Protection		Continuous, Automatic recovery
Output Current Limitation		180% typ. of I_{out} max.
Transient Response	- Response Deviation	3% typ. (25% Load Step)
	- Response Time	500 μs typ. (25% Load Step)

Safety Specifications

Standards	- IT / Multimedia Equipment	Designed for IEC/EN/UL 62368-1 (not certified)
-----------	-----------------------------	---

All specifications valid at nominal voltage, resistive full load and +25°C after warm-up time, unless otherwise stated.

EMC Specifications

EMI Emissions	- Conducted Emissions	EN 55032 class A (with external filter) EN 55032 class B (with external filter)
	- Radiated Emissions	EN 55032 class A (with external filter) EN 55032 class B (with external filter)
		External filter proposal: www.tracopower.com/overview/trn3sm
EMS Immunity		EN 55024 (IT Equipment) EN 55035 (Multimedia)
	- Electrostatic Discharge	Air: EN 61000-4-2, ±8 kV, perf. criteria A Contact: EN 61000-4-2, ±6 kV, perf. criteria A
	- RF Electromagnetic Field	EN 61000-4-3, 10 V/m, perf. criteria A
	- EFT (Burst) / Surge	EN 61000-4-4, ±2 kV, perf. criteria A EN 61000-4-5, ±1 kV, perf. criteria A
	- Conducted RF Disturbances	Ext. input component: Nippon chemi-con KY 220 µF/ 100 V EN 61000-4-6, 10 Vrms, perf. criteria A
	- PF Magnetic Field	Continuous: EN 61000-4-8, 100 A/m, perf. criteria A 1 s: EN 61000-4-8, 1000 A/m, perf. criteria A

General Specifications

Relative Humidity		95% max. (non condensing)
Temperature Ranges	- Operating Temperature	-40°C to +85°C
	- Case Temperature	+105°C max.
	- Storage Temperature	-55°C to +125°C
Power Derating	- High Temperature	2.5 %/K above 65°C
	See application note: www.tracopower.com/overview/trn3sm	
Cooling System		Natural convection (20 LFM)
Regulator Topology		RCC Converter
Switching Frequency		100 kHz min. (PFM)
Insulation System		Functional Insulation
Isolation Test Voltage	- Input to Output, 60 s	1'600 VDC
Isolation Resistance	- Input to Output, 500 VDC	1'000 MΩ min.
Isolation Capacitance	- Input to Output, 100 kHz, 1 V	75 pF max.
Reliability	- Calculated MTBF	4'400'000 h (MIL-HDBK-217F, ground benign)
Moisture Sensitivity (MSL)		Level 2 (J-STD-033C)
Washing Process		According to Cleaning Guideline www.tracopower.com/info/cleaning.pdf
Environment	- Vibration	MIL-STD-810F
	- Thermal Shock	MIL-STD-810F
Housing Material		Non-conductive Plastic (UL 94 V-0 rated)
Potting Material		Epoxy (UL 94 V-0 rated)
Pin Material		Copper
Pin Foundation Plating		Nickel (0.3 - 0.9 µm)
Pin Surface Plating		Tin (5 - 6 µm), matte
Housing Type		Plastic Case
Mounting Type		PCB Mount
Connection Type		SMD (Surface-Mount Device)
Footprint Type		SMD10
Soldering Profile		Lead-Free Reflow Soldering (acc. J-STD-020E) 245°C max. (Tp)
		30 s max. (tp, at Tp - 5°C)
		90 s max. (tL, time above 217°C)
		See application note: www.tracopower.com/info/reflow-soldering.pdf
Weight		2.1 g

All specifications valid at nominal voltage, resistive full load and +25°C after warm-up time, unless otherwise stated.

Environmental Compliance - REACH Declaration

www.tracopower.com/info/reach-declaration.pdf

- RoHS Declaration

REACH SVHC list compliant

REACH Annex XVII compliant

www.tracopower.com/info/rohs-declaration.pdf

Exemptions: 7a, 7c-I

(RoHS exemptions refer to the component concentration only, not to the overall concentration in the product (O5A rule))

- SCIP Reference Number

17b2d50b-cbe6-4fa7-b44e-fe47757c2464

Supporting Documents

Overview Link (for additional Documents)

www.tracopower.com/overview/trn3sm

Outline Dimensions

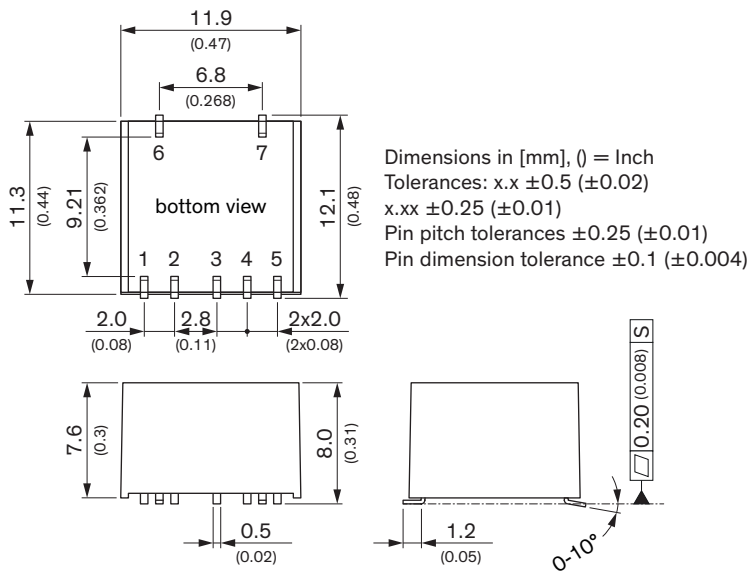

Pinout		
Pin	Single	Dual
1	-Vin (GND)	-Vin (GND)
2	+Vin (Vcc)	+Vin (Vcc)
3	+Vout	+Vout
4	No pin	Common
5	-Vout	-Vout
6	NC	NC
7	NC	NC

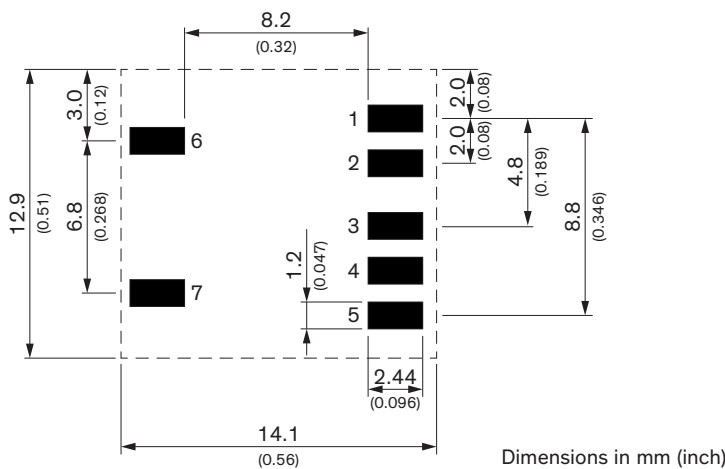

NC: Not connected

Recommended Solder Pad Layout



Looking for pricing, stock, or lifecycle information?

Click below to explore more details on WIN SOURCE:

-  [View TRN 3-4812SM on WIN SOURCE](#)
-  [Traco Power Information](#)

Optimize Your Supply Chain with WIN SOURCE Solutions

-  Global Sourcing Solution
-  Obsolete Management
-  Cost Control Management
-  Shortage Management
-  Alternative Solution
-  Excess Inventory Management