



# THE DATASHEET OF LY3200ALH





# LY3200ALH

## MEMS motion sensor: high performance $\pm 2000$ dps analog yaw-rate gyroscope

### Features

- 2.7 V to 3.6 V single supply operation
- Wide extended operating temperature range (-40°C to +85°C)
- High stability over temperature
- Analog absolute angular-rate output
- Integrated low-pass filters
- Low power consumption
- Sleep mode
- Embedded power-down
- Embedded self-test
- High shock and vibration survivability
- ECOPACK<sup>®</sup> RoHS and “Green” compliant (see [Section 6](#))

### Applications

- Gaming applications
- Pointing devices, remote and game controllers
- Motion control with user interface
- Industrial and robotics

### Description

The LY3200ALH is a high performance low-power single-axis micromachined gyroscope capable of measuring angular rate along yaw axis.

It provides excellent temperature stability and high resolution over extended operating temperature range (-40°C to +85°C).

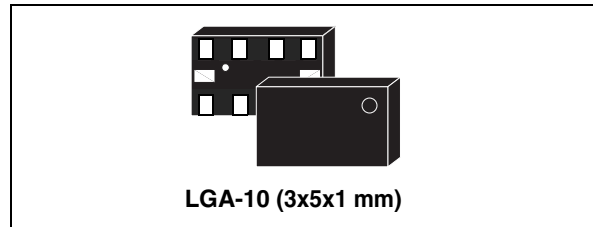

The LY3200ALH has a full scale of  $\pm 2000$  dps and is capable of detecting rates with a -3 dB bandwidth up to 140 Hz.

The device includes a sensing element composed of a single driving mass, kept in continuous oscillation and capable of reacting, based on the Coriolis principle, when an angular rate is applied.

A CMOS IC provides the measured angular rate to the external world through an analog output voltage, allowing high levels of integration and production trimming to better match sensing element characteristics.

ST's family of gyroscopes leverages on the mature and robust manufacturing process already used for the production of micro-machined accelerometers.

ST is already in the field with several hundred million sensors which have received excellent acceptance from the market in terms of quality, reliability and performance.

The LY3200ALH is available in a plastic land grid array (LGA) package, which ST successfully pioneered for accelerometers. Today ST has the widest manufacturing capability and strongest expertise in the world for production of sensors in plastic LGA packages.

**Table 1. Device summary**

Order code	Temperature range (°C)	Package	Packing
LY3200ALH	-40 to +85	LGA-10 (3x5x1)	Tray
LY3200ALHTR	-40 to +85	LGA-10 (3x5x1)	Tape and reel

# Contents

- 1      Block diagram and pin description ..... 3**
  - 1.1   Pin description ..... 3
- 2      Mechanical and electrical specifications ..... 5**
  - 2.1   Mechanical characteristics ..... 5
  - 2.2   Electrical characteristics ..... 6
- 3      Absolute maximum ratings ..... 7**
- 4      Terminology ..... 8**
  - 4.1   Sensitivity ..... 8
  - 4.2   Zero-rate level ..... 8
  - 4.3   Self-test ..... 8
  - 4.4   Sleep mode, self test and power down ..... 8
- 5      Application hints ..... 9**
  - 5.1   Output response vs. rotation ..... 10
  - 5.2   Soldering information ..... 10
- 6      Package information ..... 11**
- 7      Revision history ..... 12**

# 1 Block diagram and pin description

Figure 1. Block diagram

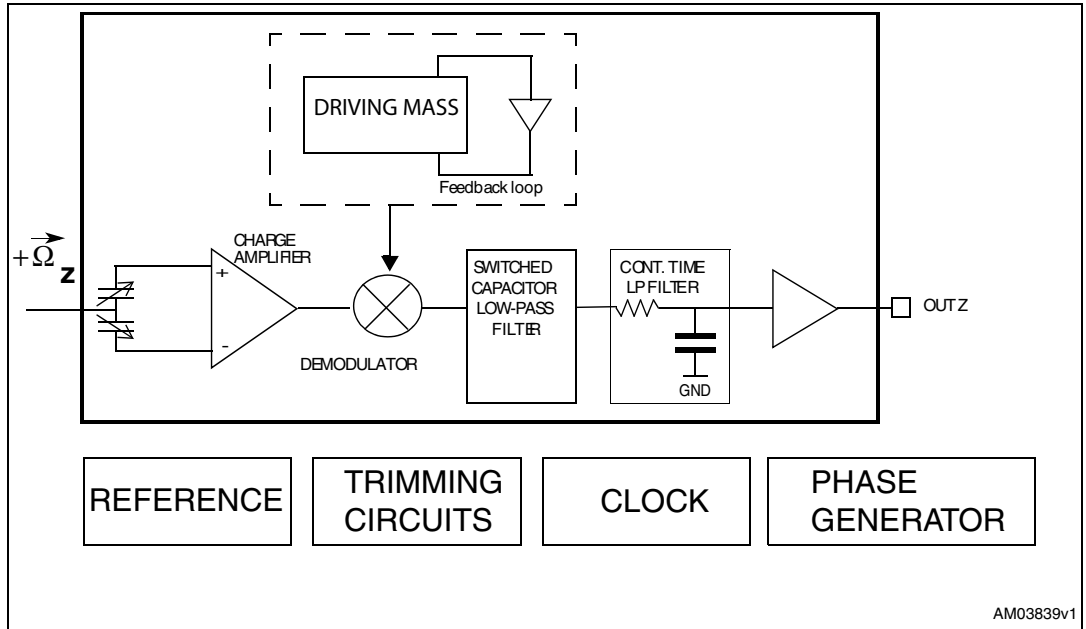

## 1.1 Pin description

Figure 2. Pin connection

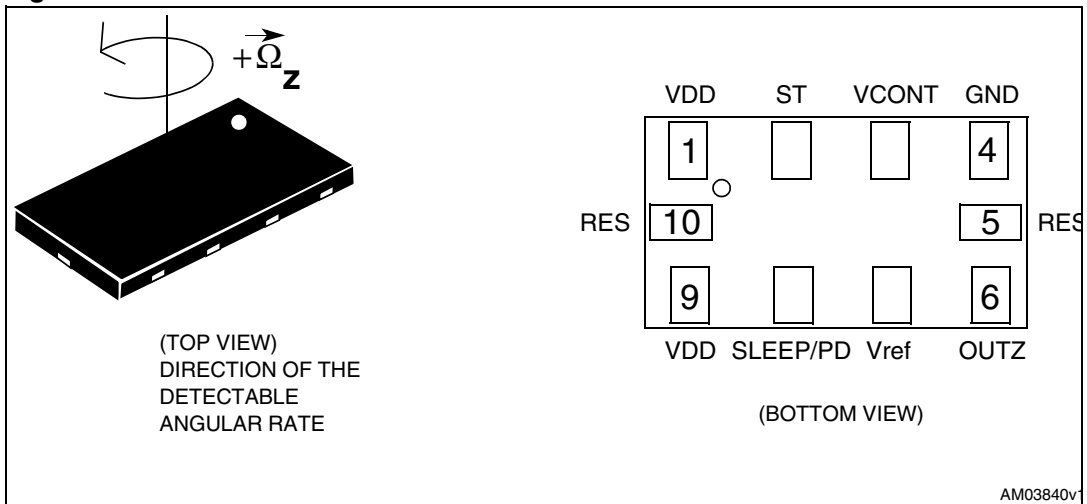

**Table 2. Pin description**

Pin #	Pin name	Analog function
1	Vdd	Power supply
2	ST	Self-test (see <a href="#">Table 6</a> )
3	VCONT	PLL filter connection
4	GND	0V supply voltage
5	Res	Leave unconnected or connect to Vdd
6	OUTZ	Z axis output voltage
7	Vref	Reference voltage
8	SLEEP/PD	Sleep mode / power-down mode (see <a href="#">Table 6</a> )
9	Vdd	Power supply
10	Res	Leave unconnected or connect to Vdd

## 2 Mechanical and electrical specifications

### 2.1 Mechanical characteristics

Vdd = 3 V, T = 25 °C unless otherwise noted <sup>(a)</sup>

**Table 3. Mechanical characteristics**

Symbol	Parameter	Test condition	Min.	Typ. <sup>(1)</sup>	Max.	Unit
FS	Measurement range			±2000		dps
So	Sensitivity <sup>(2)</sup>			0.67		mV/dps
SoDr	Sensitivity change vs. temperature	Delta from 25°C		0.01		%/°C
Voff	Zero-rate level <sup>(3)</sup>			1.5		V
OffDr	Zero-rate level change vs. temperature	Delta from 25°C		0.09		dps/°C
NL	Non linearity	Best fit straight line		±1		% FS
BW	Bandwidth <sup>(3)</sup>			140		Hz
Vst	Self-test output change			400 <sup>(4)</sup>		mV
Rn	Rate noise density			0.074		dps/√Hz
Top	Operating temperature range		-40		+85	°C

1. Typical specifications are not guaranteed.
2. Sensitivity and zero-rate offset are not ratiometric to supply voltage.
3. The product is capable of measuring angular rates extending from DC to the selected BW.
4. Self test typical absolute value.

a. The product is factory calibrated at 3 V. The operational power supply range is specified in [Table 4](#).

## 2.2 Electrical characteristics

Vdd = 3 V, T = 25 °C unless otherwise noted <sup>(b)</sup>

**Table 4. Electrical characteristics**

Symbol	Parameter	Test condition	Min.	Typ. <sup>(1)</sup>	Max.	Unit
Vdd	Supply voltage		2.7	3	3.6	V
Idd	Supply current			4.2		mA
IddSI	Supply current sleep mode			2.2		mA
IddPdn	Supply current power-down mode			5		μA
VST	Self-test input	Logic 0 level	0		0.2*Vdd	V
		Logic 1 level	0.8*Vdd		Vdd	
VPD	Power-down input	Logic 0 level	0		0.2*Vdd	V
		Logic 1 level	0.8*Vdd		Vdd	
Top	Operating temperature range		-40		+85	°C

1. Typical specifications are not guaranteed.

b. The product is factory calibrated at 3 V

### 3 Absolute maximum ratings

Stresses above those listed as “Absolute maximum ratings” may cause permanent damage to the device. This is a stress rating only and functional operation of the device under these conditions is not implied. Exposure to maximum rating conditions for extended periods may affect device reliability.

**Table 5. Absolute maximum ratings**

Symbol	Ratings	Maximum value	Unit
V <sub>dd</sub>	Supply voltage	-0.3 to 6	V
V <sub>in</sub>	Input voltage on any control pin (SLEEP/PD, ST)	-0.3 to V <sub>dd</sub> +0.3	V
A	Acceleration	3000 for 0.5 ms	<i>g</i>
		10000 for 0.1 ms	<i>g</i>
T <sub>STG</sub>	Storage temperature range	-40 to +125	°C
ESD	Electrostatic discharge protection	2 (HBM)	kV



This is a mechanical shock sensitive device, improper handling can cause permanent damage to the part



This is an ESD sensitive device, improper handling can cause permanent damage to the part

## 4 Terminology

### 4.1 Sensitivity

An angular rate gyroscope is a device that produces a positive-going output voltage for counterclockwise rotation around the sensitive axis considered. Sensitivity describes the gain of the sensor and can be determined by applying a defined angular velocity to it. This value changes very little over temperature and time.

### 4.2 Zero-rate level

Zero-rate level describes the actual output signal if there is no angular rate present. The zero-rate level of precise MEMS sensors is, to some extent, a result of stress to the sensor and therefore zero-rate level can slightly change after mounting the sensor onto a printed circuit board or after exposing it to extensive mechanical stress. This value changes very little over temperature and time.

### 4.3 Self-test

Self-test allows testing of the mechanical and electrical part of the sensor, allowing the seismic mass to be moved by means of an electrostatic test-force. The self-test function is off when the ST pin is connected to GND. When the ST pin is tied to Vdd, an actuation force is applied to the sensor, emulating a definite Coriolis force. In this case the sensor output exhibits a voltage change in its DC level which is also dependent on the supply voltage. When ST is active, the device output level is given by the algebraic sum of the signals produced by the velocity acting on the sensor and by the electrostatic test-force. If the output signals change within the amplitude specified in [Table 3](#), then the mechanical element is working properly and the parameters of the interface chip are within the defined specifications.

### 4.4 Sleep mode, self test and power down

The LY3200ALH enables advanced power-saving features thanks to the availability of three different operating modes. When the device is set in a Sleep mode configuration, the reading chain is completely turned off, resulting in low power consumption. In this condition the device turn-on time is significantly reduced, allowing simple external power cycling.

In accordance with the table below, the user can select the desired operating mode using two dedicated pins (ST and SLEEP/PD).

**Table 6. Sleep mode and Power-down mode configuration**

Operating mode	ST pin	SLEEP/PD pin
Normal mode	0	0
Sleep mode	0	1
Self-test	1	0
Power-down	1	1

## 5 Application hints

**Figure 3. LY3200ALH electrical connections and external components values**

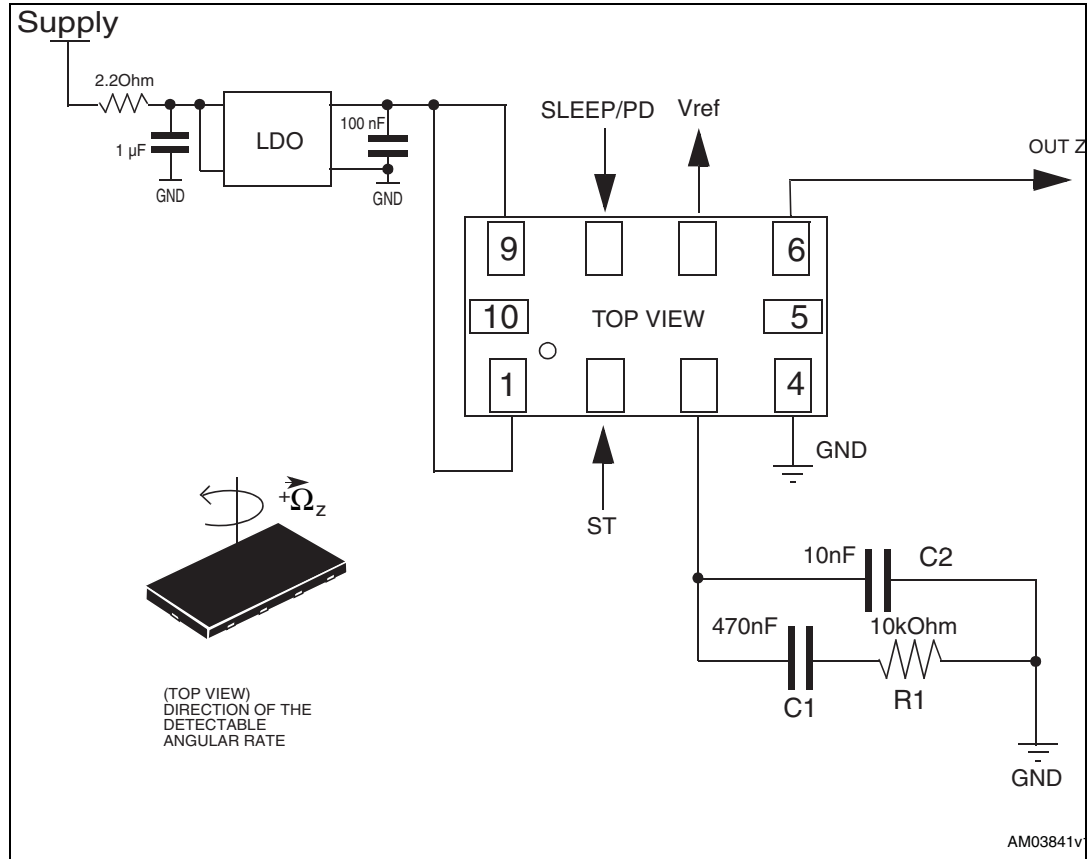

Power supply decoupling capacitors should be placed in combination with an LDO regulator (common design practice).

The LY3200ALH IC includes a PLL (phase-locked loop) circuit to synchronize driving and sensing interfaces. Capacitors and resistors must be added at **VCONT** pin 3 (as shown in [Figure 3](#)) to implement a low-pass filter.

## 5.1 Output response vs. rotation

Figure 4. Output response vs. rotation

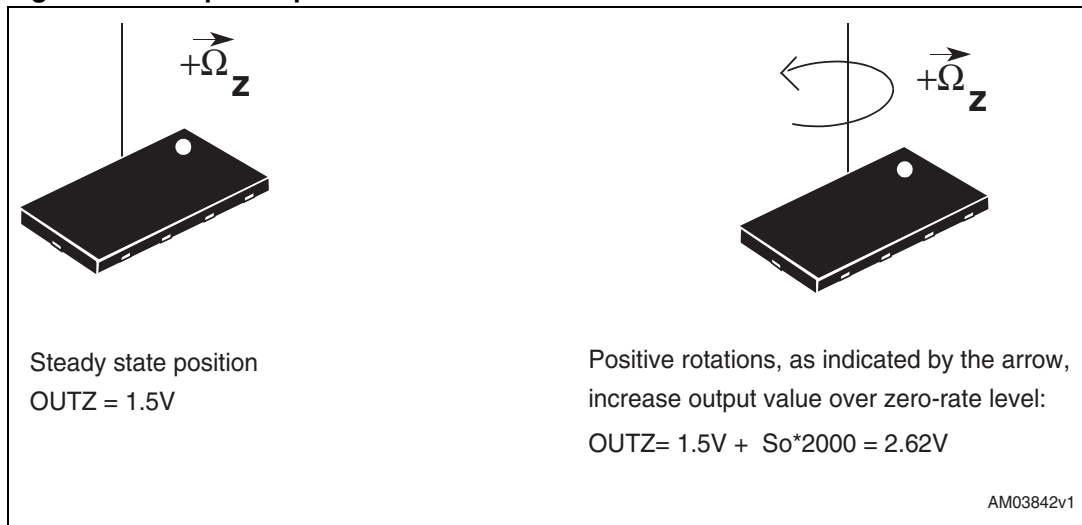

## 5.2 Soldering information

The LGA package is compliant with the ECOPACK<sup>®</sup>, RoHS and “Green” standard. It is qualified for soldering heat resistance according to JEDEC J-STD-020.

Leave “Pin 1 indicator” unconnected during soldering.

Land pattern and soldering recommendations are available at [www.st.com](http://www.st.com)

## 6 Package information

In order to meet environmental requirements, ST offers these devices in different grades of ECOPACK® packages, depending on their level of environmental compliance. ECOPACK® specifications, grade definitions and product status are available at: [www.st.com](http://www.st.com). ECOPACK is an ST trademark.

**Figure 5. LGA-10: mechanical data and package dimensions**

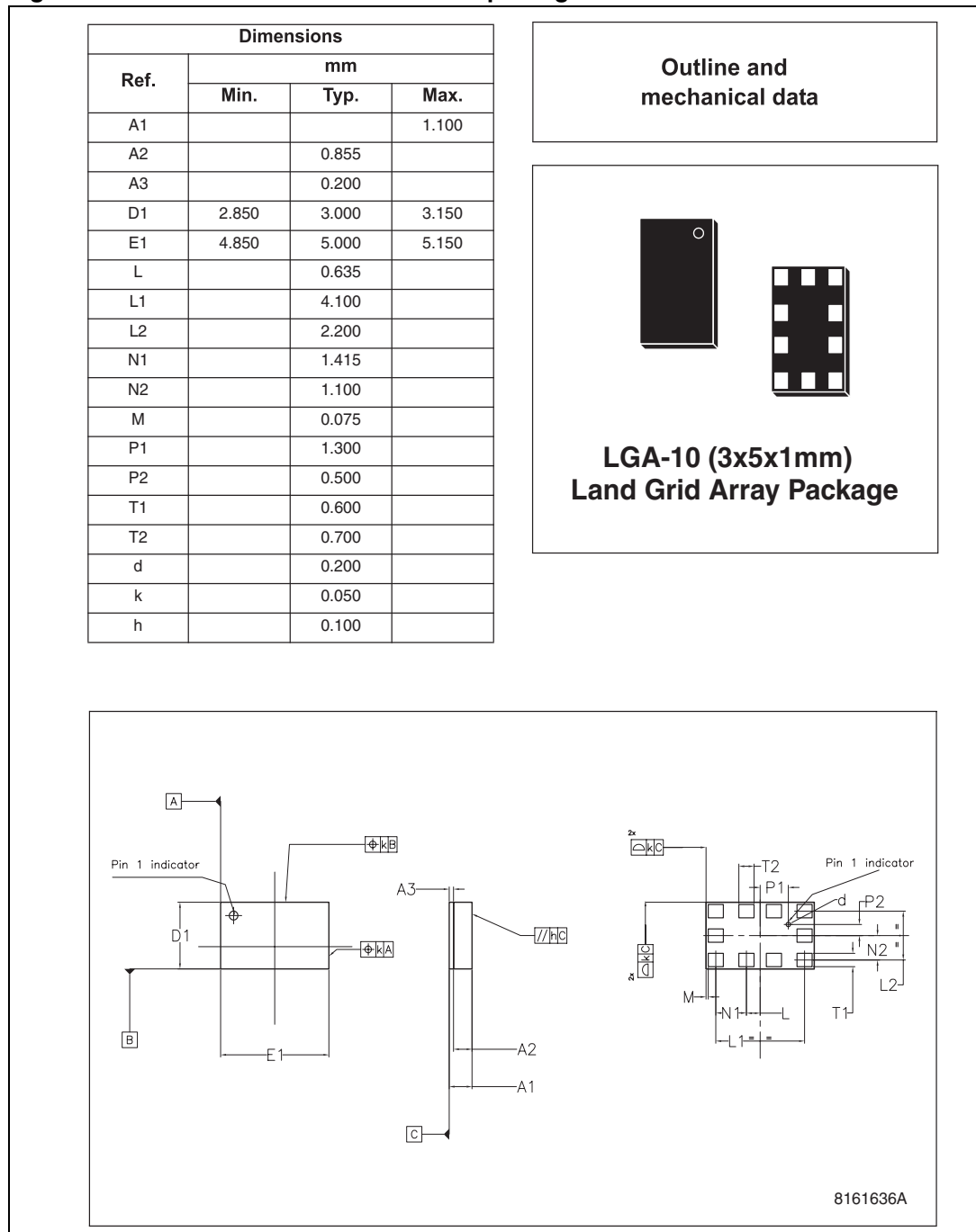

## 7 Revision history

**Table 7. Document revision history**

Date	Revision	Changes
29-Oct-2009	1	First issue

**Please Read Carefully:**

Information in this document is provided solely in connection with ST products. STMicroelectronics NV and its subsidiaries ("ST") reserve the right to make changes, corrections, modifications or improvements, to this document, and the products and services described herein at any time, without notice.

All ST products are sold pursuant to ST's terms and conditions of sale.

Purchasers are solely responsible for the choice, selection and use of the ST products and services described herein, and ST assumes no liability whatsoever relating to the choice, selection or use of the ST products and services described herein.

No license, express or implied, by estoppel or otherwise, to any intellectual property rights is granted under this document. If any part of this document refers to any third party products or services it shall not be deemed a license grant by ST for the use of such third party products or services, or any intellectual property contained therein or considered as a warranty covering the use in any manner whatsoever of such third party products or services or any intellectual property contained therein.

**UNLESS OTHERWISE SET FORTH IN ST'S TERMS AND CONDITIONS OF SALE ST DISCLAIMS ANY EXPRESS OR IMPLIED WARRANTY WITH RESPECT TO THE USE AND/OR SALE OF ST PRODUCTS INCLUDING WITHOUT LIMITATION IMPLIED WARRANTIES OF MERCHANTABILITY, FITNESS FOR A PARTICULAR PURPOSE (AND THEIR EQUIVALENTS UNDER THE LAWS OF ANY JURISDICTION), OR INFRINGEMENT OF ANY PATENT, COPYRIGHT OR OTHER INTELLECTUAL PROPERTY RIGHT.**

**UNLESS EXPRESSLY APPROVED IN WRITING BY AN AUTHORIZED ST REPRESENTATIVE, ST PRODUCTS ARE NOT RECOMMENDED, AUTHORIZED OR WARRANTED FOR USE IN MILITARY, AIR CRAFT, SPACE, LIFE SAVING, OR LIFE SUSTAINING APPLICATIONS, NOR IN PRODUCTS OR SYSTEMS WHERE FAILURE OR MALFUNCTION MAY RESULT IN PERSONAL INJURY, DEATH, OR SEVERE PROPERTY OR ENVIRONMENTAL DAMAGE. ST PRODUCTS WHICH ARE NOT SPECIFIED AS "AUTOMOTIVE GRADE" MAY ONLY BE USED IN AUTOMOTIVE APPLICATIONS AT USER'S OWN RISK.**

Resale of ST products with provisions different from the statements and/or technical features set forth in this document shall immediately void any warranty granted by ST for the ST product or service described herein and shall not create or extend in any manner whatsoever, any liability of ST.

ST and the ST logo are trademarks or registered trademarks of ST in various countries.

Information in this document supersedes and replaces all information previously supplied.

The ST logo is a registered trademark of STMicroelectronics. All other names are the property of their respective owners.

© 2009 STMicroelectronics - All rights reserved

STMicroelectronics group of companies



Australia - Belgium - Brazil - Canada - China - Czech Republic - Finland - France - Germany - Hong Kong - India - Israel - Italy - Japan - Malaysia - Malta - Morocco - Philippines - Singapore - Spain - Sweden - Switzerland - United Kingdom - United States of America

[www.st.com](http://www.st.com)



## Looking for pricing, stock, or lifecycle information?

Click below to explore more details on WIN SOURCE:

-  [View LY3200ALH on WIN SOURCE](#)
-  [STMicroelectronics Information](#)

## Optimize Your Supply Chain with WIN SOURCE Solutions

-  Global Sourcing Solution
-  Obsolete Management
-  Cost Control Management
-  Shortage Management
-  Alternative Solution
-  Excess Inventory Management