



**THE DATASHEET OF  
TS1107-200ITQ1633T**



# TS1107/10 Data Sheet

## Electronic Circuit Breaker: High Side Current Sense Amplifier with Current Limiter Comparator and FET Control (TS1110 only)

The TS1110 Electronic Circuit Breaker uses a bidirectional current-sense amplifier for current limit detection to disconnect the load by use of an external P-channel MOSFET. An internal Current Limit Comparator with an adjustable threshold provides a latch capable output to signal when a fault condition has occurred. Once the Current Limit Comparator's output is latched the internal FET control is enabled which drives the gate of the external P-channel MOSFET, disconnecting the load from the power supply. Once the fault condition is removed, the system may be reset by strobing or pulling the latch enable pin, CLATCH, low. The Circuit Breaker system delay of the TS1110 is typically 428  $\mu$ s. The Current Limiter system delay of the TS1107 and TS1110 is typically 670  $\mu$ s.

### Applications

- Power Management Systems
- Portable/Battery-Powered Systems
- Smart Chargers
- Battery Monitoring
- Overcurrent and Undercurrent Detection
- Remote Sensing
- Industrial Controls

### KEY FEATURES

- Circuit Breaker with Latching Load Disconnect
- Internal Latching Current Limiter Comparator with CLATCH Reset
- Programmable Current Limit
- COUT Output Signals Fault Condition
- Low Supply Current
  - Current Sense Amplifier: 0.68  $\mu$ A
  - TS1110  $I_{VDD}$ : 1.16  $\mu$ A
  - TS1107  $I_{VDD}$ : 1.15  $\mu$ A
- High Side Bidirectional Current Sense Amplifier
- Wide CSA Input Common Mode Range: +2 V to +27 V
- Low CSA Input Offset Voltage: 150  $\mu$ V(max)
- Low Gain Error: 1% (max)
- Two Gain Options Available for TS1107 and TS1110:
  - Gain = 20 V/V : TS1107-20 and TS1110-20
  - Gain = 200 V/V : TS1107-200 and TS1110-200
- 16-Pin TQFN Packaging (3 mm x 3 mm)

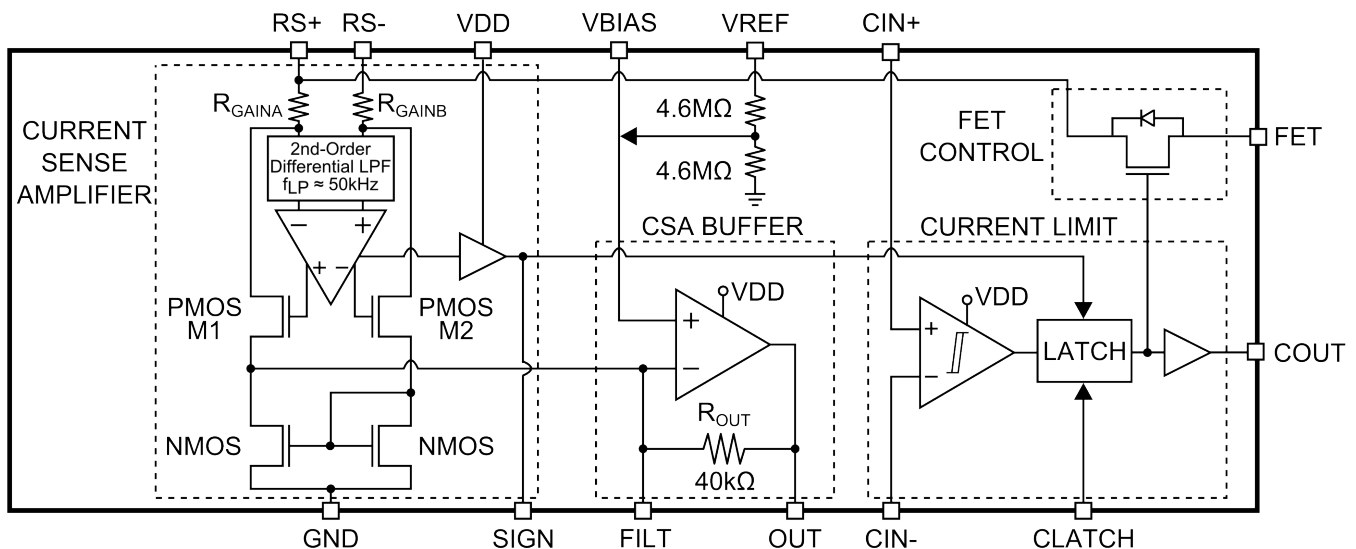

## 1. Ordering Information

**Table 1.1. Ordering Part Numbers**

Ordering Part Number	Description	FET Control	Gain V/V
TS1107-20ITQ1633	Electronic Circuit Breaker: High Side Current Sense Amplifier with Current Limiter Comparator	No	20
TS1107-200ITQ1633	Electronic Circuit Breaker: High Side Current Sense Amplifier with Current Limiter Comparator	No	200
TS1110-20ITQ1633	Electronic Circuit Breaker: High Side Current Sense Amplifier with Current Limiter Comparator and FET Control	Yes	20
TS1110-200ITQ1633	Electronic Circuit Breaker: High Side Current Sense Amplifier with Current Limiter Comparator and FET Control	Yes	200

**Note:** Adding the suffix “T” to the part number (e.g. TS1107-200ITQ1633T) denotes tape and reel.

## 2. System Overview

### 2.1 Functional Block Diagrams

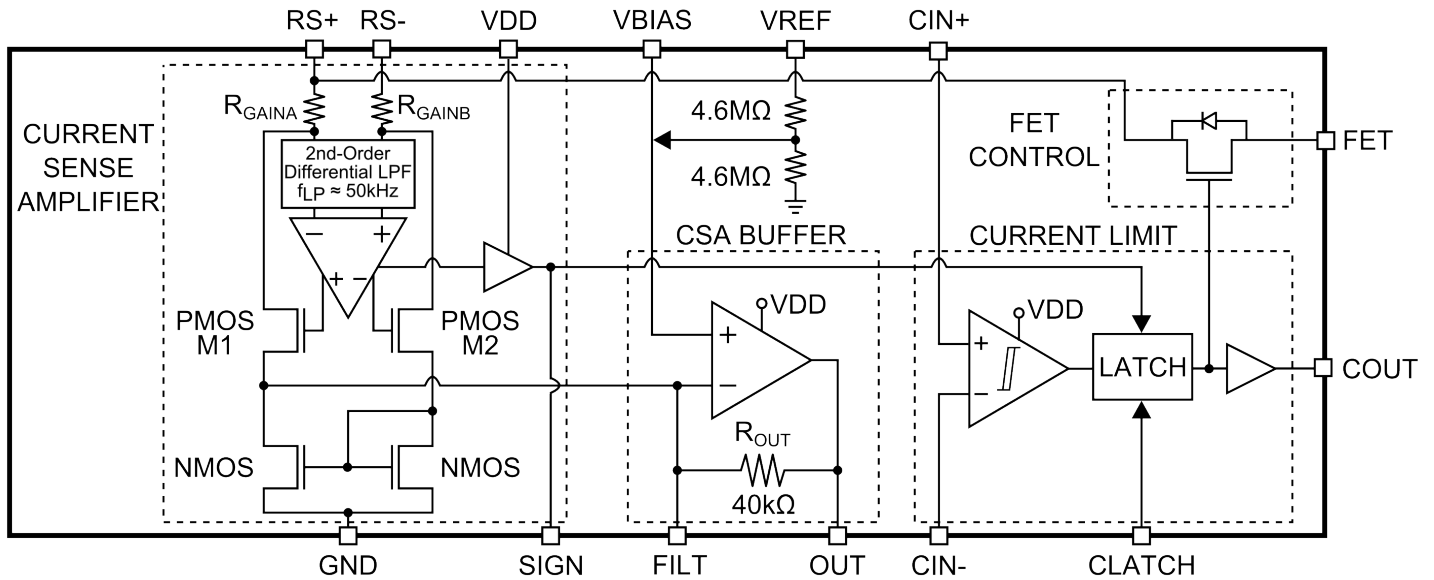

Figure 2.1. TS1110 Current Limit with FET Control Block Diagram

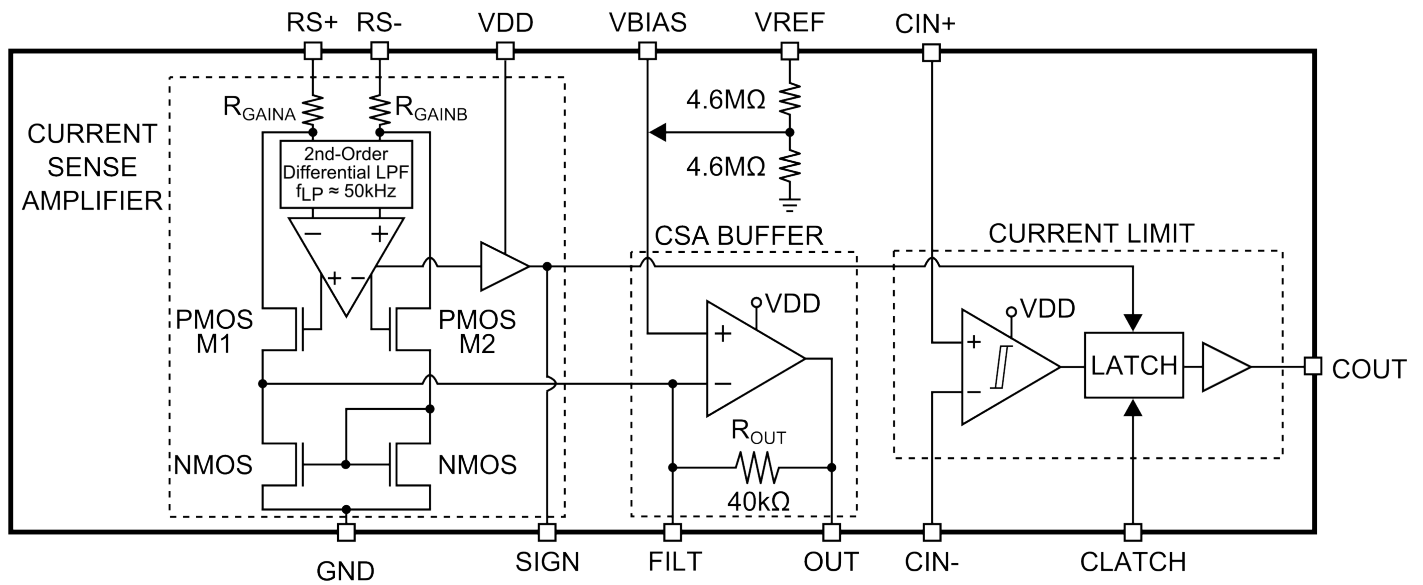

Figure 2.2. TS1107 Current Limit Block Diagram

## 2.2 Current Sense Amplifier + Output Buffer

The internal configuration of the TS1107/10 bidirectional current-sense amplifier is a variation of the TS1101 bidirectional current-sense amplifier. The TS1107/10 current-sense amplifier is configured for fully differential input/output operation.

Referring to the block diagram, the inputs of the TS1107/10's differential input/output amplifier are connected to RS+ and RS– across an external R<sub>SENSE</sub> resistor that is used to measure current. At the non-inverting input of the current-sense amplifier, the applied voltage difference in voltage between RS+ and RS– is I<sub>LOAD</sub> × R<sub>SENSE</sub>. Since the RS– terminal is the non-inverting input of the internal op-amp, the current-sense op-amp action drives PMOS[1/2] to drive current across R<sub>GAIN[A/B]</sub> to equalize voltage at its inputs.

Thus, since the M1 PMOS source is connected to the inverting input of the internal op-amp and since the voltage drop across R<sub>GAINA</sub> is the same as the external V<sub>SENSE</sub>, the M1 PMOS drain-source current is equal to:

$$I_{DS(M1)} = \frac{V_{SENSE}}{R_{GAINA}}$$

or

$$I_{DS(M1)} = \frac{I_{LOAD} \times R_{SENSE}}{R_{GAINA}}$$

The drain terminal of the M1 PMOS is connected to the transimpedance amplifier's gain resistor, R<sub>OUT</sub>, via the inverting terminal. The non-inverting terminal of the transimpedance amplifier is internally connected to V<sub>BIAS</sub>, therefore the output voltage of the TS1107/10 at the OUT terminal is:

$$V_{OUT} = V_{BIAS} - I_{LOAD} \times R_{SENSE} \times \frac{R_{OUT}}{R_{GAINA}}$$

When the voltage at the RS– terminal is greater than the voltage at the RS+ terminal, the external V<sub>SENSE</sub> voltage drop is impressed upon R<sub>GAINB</sub>. The voltage drop across R<sub>GAINB</sub> is then converted into a current by the M2 PMOS. The M2 PMOS drain-source current is the input current for the NMOS current mirror which is matched with a 1-to-1 ratio. The transimpedance amplifier sources the M2 PMOS drain-source current for the NMOS current mirror. Therefore the output voltage of the TS1107/10 at the OUT terminal is:

$$V_{OUT} = V_{BIAS} + I_{LOAD} \times R_{SENSE} \times \frac{R_{OUT}}{R_{GAINB}}$$

When M1 is conducting current (V<sub>RS+</sub> > V<sub>RS–</sub>), the TS1107/10's internal amplifier holds M2 OFF. When M2 is conducting current (V<sub>RS–</sub> > V<sub>RS+</sub>), the internal amplifier holds M1 OFF. In either case, the disabled PMOS does not contribute to the resultant output voltage.

The current-sense amplifier's gain accuracy is therefore the ratio match of R<sub>OUT</sub> to R<sub>GAIN[A/B]</sub>. For each of the gain options available, The following table lists the values for R<sub>GAIN[A/B]</sub>.

**Table 2.1. Internal Gain Setting Resistors (Typical Values)**

GAIN (V/V)	R <sub>GAIN[A/B]</sub> (Ω)	R <sub>OUT</sub> (Ω)	Part Number
20	2 k	40 k	TS1110-20
200	200	40 k	TS1110-200
20	2 k	40 k	TS1107-20
200	200	40 k	TS1107-200

The TS1107/10 allows access to the inverting terminal of the transimpedance amplifier by the FILT pin, whereby a series RC filter may be connected to reduce noise at the OUT terminal. The recommended RC filter is 4 kΩ and 0.47 μF connected in series from FILT to GND to suppress the noise. Any capacitance at the OUT terminal should be minimized for stable operation of the buffer.

### 2.3 Sign Output

The TS1107/10 SIGN output indicates the load current's direction. The SIGN output is a logic HIGH when M1 is conducting current ( $V_{RS+} > V_{RS-}$ ). Alternatively, the SIGN output is a logic LOW when M2 is conducting current ( $V_{RS-} > V_{RS+}$ ). The SIGN comparator's transfer characteristic is illustrated in Figure 1. Unlike other current-sense amplifiers that implement an OUT/SIGN arrangement, the TS1107/10 exhibits no "dead zone" at ILOAD switchover.

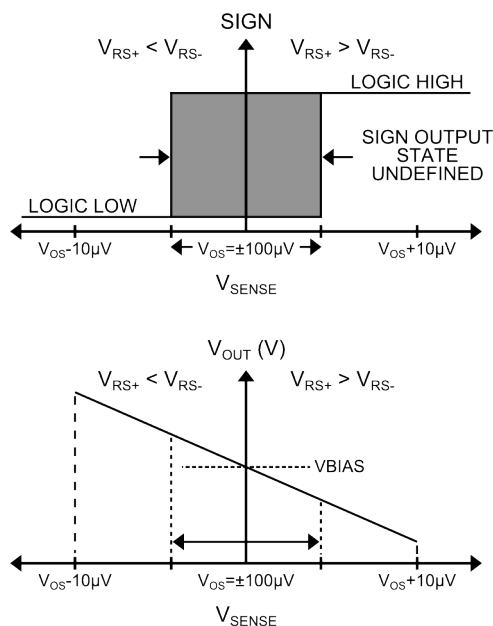

Figure 2.3. TS1107/10 Sign Output Transfer Characteristic

### 2.4 Current Limit Comparator

The TS1107/10 provides a comparator which can be used for current limit detection. The current limit threshold can be set to detect either positive or negative current, though it provides fastest response in the positive direction. In a typical configuration, the inverting terminal, CIN- is connected to OUT. The non-inverting terminal of the comparator, CIN+, should be supplied with an external voltage or a resistor divider from the supply voltage, which is used as the threshold voltage for the current limiter. The output of the comparator is latch capable only when the Sign Comparator is HIGH ( $V_{RS+} > V_{RS-}$ ), and CLATCH is held HIGH. Once the comparator output (COUT) is triggered, COUT will latch HIGH and maintain the HIGH state as long as CLATCH is held HIGH. To reset COUT to the default comparator output state, CLATCH must be held or strobed LOW.

### 2.5 FET Control (TS1110 Only)

A "circuit breaker" feature is supplied within the TS1110 as a FET control which drives the gate drive of an external P-channel MOS-FET. When the Current Limit Comparator's output goes HIGH and the LATCH feature is enabled, the FET control output will latch HIGH thereby disconnecting current flow to the load by holding the gate of the external PMOS HIGH. To resume current flow to the load, the FET control must be brought low by holding or strobing CLATCH low. The output of the comparator controls the gate logic of an internal FET whereby the source is connected to the non-inverting terminal of the CSA, RS+, while the drain is fed to the FET pin. The FET pin is intended to drive the gate of an external PMOS, where the PMOS source is connected to the inverting terminal of the CSA, RS-, and the drain is connected to the external load. FET will maintain its logic LOW state while the comparator output, COUT, is LOW. When COUT is latched HIGH, the FET pin will latch to a HIGH state, thereby switching and holding the external PMOS OFF. The FET control features a Turn ON Time,  $t_{FET(ON)}$ , of 720 ns(typ) and a Turn OFF Time,  $t_{FET(OFF)}$ , of 2.9 ms(typ) when driving a 860 pF gate capacitance. Note that the FET Control is a pull-up only. A pull-down resistor is required from the external FET's gate to ground to ensure the FET is normally ON.

### 2.6 VREF Divider

The TS1107/10 provides an internal voltage divider network to set VBIAS, eliminating the need for externally setting the voltage. The VREF Divider is activated once the voltage applied to VREF is 0.9 V or greater. The VREF divider connects to VBIAS, where the VBIAS voltage is equal to 50% of VREF. The VREF Divider exhibits a total series resistance of 9.2 MΩ from VREF to GND.

## 2.7 Selecting a Sense Resistor

Selecting the optimal value for the external  $R_{SENSE}$  is based on the following criteria and for each commentary follows:

1.  $R_{SENSE}$  Voltage Loss
2.  $V_{OUT}$  Swing vs. Desired  $V_{SENSE}$  and Applied Supply Voltage at VDD
3. Total  $I_{LOAD}$  Accuracy
4. Circuit Efficiency and Power Dissipation
5.  $R_{SENSE}$  Kelvin Connections

### 2.7.1 RSENSE Voltage Loss

For lowest IR power dissipation in  $R_{SENSE}$ , the smallest usable resistor value for  $R_{SENSE}$  should be selected.

### 2.7.2 VOUT Swing vs. Desired VSENSE and Applied Supply Voltage at VDD

Although the Current Sense Amplifier draws its power from the voltage at its  $RS+$  and  $RS-$  terminals, the signal voltage at the OUT terminal is provided by a buffer, and is therefore bounded by the buffer's output range. As shown in the Electrical Characteristics table, the CSA Buffer has a maximum and minimum output voltage of:

$$V_{OUT(max)} = VDD_{(min)} - 0.2V$$

$$V_{OUT(min)} = 0.2V$$

Therefore, the full-scale sense voltage should be chosen so that the OUT voltage is neither greater nor less than the maximum and minimum output voltage defined above. To satisfy this requirement, the positive full-scale sense voltage,  $V_{SENSE(pos\_max)}$ , should be chosen so that:

$$V_{SENSE(pos\_max)} < \frac{VBIAS - V_{OUT(min)}}{GAIN}$$

The negative full-scale sense voltage,  $V_{SENSE(neg\_min)}$ , should be chosen so that:

$$V_{SENSE(neg\_min)} < \frac{V_{OUT(max)} - VBIAS}{GAIN}$$

For best performance,  $R_{SENSE}$  should be chosen so that the full-scale  $V_{SENSE}$  is less than  $\pm 75$  mV.

### 2.7.3 Total Load Current Accuracy

In the TS1107/10's linear region where  $V_{OUT(min)} < V_{OUT} < V_{OUT(max)}$ , there are two specifications related to the circuit's accuracy: a) the TS1107/10 CSA's input offset voltage ( $V_{OS(max)} = 150 \mu V$ ), b) the TS1107/10 CSA's gain error ( $GE_{(max)} = 1\%$ ). An expression for the TS110's total error is given by:

$$V_{OUT} = VBIAS - [GAIN \times (1 \pm GE) \times V_{SENSE}] \pm (GAIN \times V_{OS})$$

A large value for  $R_{SENSE}$  permits the use of smaller load currents to be measured more accurately because the effects of offset voltages are less significant when compared to larger  $V_{SENSE}$  voltages. Due care though should be exercised as previously mentioned with large values of  $R_{SENSE}$ .

### 2.7.4 Circuit Efficiency and Power Dissipation

IR losses in  $R_{SENSE}$  can be large especially at high load currents. It is important to select the smallest, usable  $R_{SENSE}$  value to minimize power dissipation and to keep the physical size of  $R_{SENSE}$  small. If the external  $R_{SENSE}$  is allowed to dissipate significant power, then its inherent temperature coefficient may alter its design center value, thereby reducing load current measurement accuracy. Precisely because the TS1107/10 CSA's input stage was designed to exhibit a very low input offset voltage, small  $R_{SENSE}$  values can be used to reduce power dissipation and minimize local hot spots on the pcb.

### 2.7.5 RSENSE Kelvin Connections

For optimal  $V_{SENSE}$  accuracy in the presence of large load currents, parasitic pcb track resistance should be minimized. Kelvin-sense pcb connections between  $R_{SENSE}$  and the TS1107/10's  $RS+$  and  $RS-$  terminals are strongly recommended. The drawing below illustrates the connections between the current-sense amplifier and the current-sense resistor. The pcb layout should be balanced and symmetrical to minimize wiring-induced errors. In addition, the pcb layout for  $R_{SENSE}$  should include good thermal management techniques for optimal  $R_{SENSE}$  power dissipation.

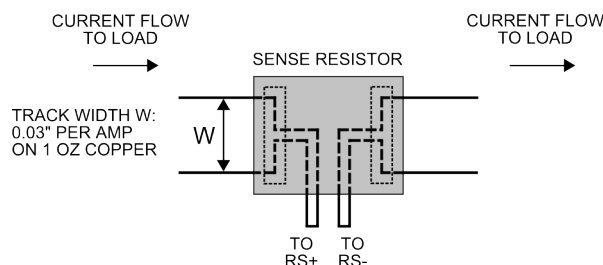

Figure 2.4. Making PCB Connections to  $R_{SENSE}$

### 2.7.6 RSENSE Composition

Current-shunt resistors are available in metal film, metal strip, and wire-wound constructions. Wire-wound current-shunt resistors are constructed with wire spirally wound onto a core. As a result, these types of current shunt resistors exhibit the largest self-inductance. In applications where the load current contains high-frequency transients, metal film or metal strip current sense resistors are recommended.

### 2.7.7 Internal Noise Filter

In power management and motor control applications, current-sense amplifiers are required to measure load currents accurately in the presence of both externally-generated differential and common-mode noise. An example of differential-mode noise that can appear at the inputs of a current-sense amplifier is high-frequency ripple. High-frequency ripple (whether injected into the circuit inductively or capacitively) can produce a differential-mode voltage drop across the external current-shunt resistor,  $R_{SENSE}$ . An example of externally-generated, common-mode noise is the high-frequency output ripple of a switching regulator that can result in common-mode noise injection into both inputs of a current-sense amplifier.

Even though the load current signal bandwidth is dc, the input stage of any current-sense amplifier can rectify unwanted, out-of-band noise that can result in an apparent error voltage at its output. Against common-mode injection noise, the current-sense amplifier's internal common-mode rejection ratio is 130 dB (typ).

To counter the effects of externally-injected noise, the TS1107/10 incorporates a 50 kHz (typ), 2nd-order differential low-pass filter as shown in the TS1107/10's block diagram, thereby eliminating the need for an external low-pass filter which can generate errors in the offset voltage and the gain error.

### 2.7.8 PC Board Layout and Power-Supply Bypassing

For optimal circuit performance, the TS1107/10 should be in very close proximity to the external current-sense resistor and the pcb tracks from  $R_{SENSE}$  to the  $RS+$  and the  $RS-$  input terminals of the TS1107/10 should be short and symmetric. Also recommended are surface mount resistors and capacitors, as well as a ground plane.

### 3. Electrical Characteristics

**Table 3.1. Recommended Operating Conditions<sup>1</sup>**

Parameter	Symbol	Conditions	Min	Typ	Max	Units
<b>System Specifications</b>						
Operating Voltage Range	V <sub>DD</sub>		1.7	—	5.25	V
Common-Mode Input Range	V <sub>CM</sub>	V <sub>RS+</sub> , Guaranteed by CMRR	2	—	27	V
<b>Note:</b>						
1. All devices 100% production tested at T <sub>A</sub> = +25 °C. Limits over Temperature are guaranteed by design and characterization.						

**Table 3.2. DC Characteristics<sup>1</sup>**

Parameter	Symbol	Conditions	Min	Typ	Max	Units	
<b>System Specifications</b>							
No Load Input Supply Current	I <sub>RS+</sub> + I <sub>RS-</sub>	See Note 2	—	0.68	1.2	μA	
	I <sub>VDD</sub>	See Note 2	TS1107	—	1.15	1.84	μA
			TS1110	—	1.16	1.85	μA
<b>Current Sense Amplifier</b>							
Common Mode Rejection Ratio	CMRR	2 V < V <sub>RS+</sub> < 27 V	120	130	—	dB	
Input Offset Voltage <sup>3</sup>	V <sub>OS</sub>	T <sub>A</sub> = +25 °C	—	±100	±150	μV	
		−40 °C < T <sub>A</sub> < +85 °C	—	—	±200	μV	
V <sub>OS</sub> Hysteresis <sup>4</sup>	V <sub>HYS</sub>	T <sub>A</sub> = +25 °C	—	10	—	μV	
Gain	G	TS1107-20, TS1110-20	—	20	—	V/V	
		TS1107-200, TS1110-200	—	200	—	V/V	
Positive Gain Error <sup>5</sup>	GE+	T <sub>A</sub> = +25 °C	—	±0.1	±0.6	%	
		−40 °C < T <sub>A</sub> < +85 °C	—	—	±1	%	
Negative Gain Error <sup>5</sup>	GE−	T <sub>A</sub> = +25 °C	—	±0.6	±1	%	
		−40 °C < T <sub>A</sub> < +85 °C	—	—	±1.4	%	
Gain Match <sup>5</sup>	GM	T <sub>A</sub> = +25 °C	—	±0.6	±1	%	
		−40 °C < T <sub>A</sub> < +85 °C	—	—	±1.4	%	
Transfer Resistance	R <sub>OUT</sub>	From FILT to OUT	28	40	52.8	kΩ	
<b>CSA Buffer</b>							
Input Bias Current	I <sub>Buffer_BIAS</sub>	−40 °C < T <sub>A</sub> < +85 °C	—	0.3	—	nA	
Input referred DC Offset	V <sub>Buffer_OS</sub>		—	—	±2.5	mV	
Offset Drift	TCV <sub>Buffer_OS</sub>	−40 °C < T <sub>A</sub> < +85 °C	—	0.6	—	μV/°C	
Input Common Mode Range	V <sub>Buffer_CM</sub>	−40 °C < T <sub>A</sub> < +85 °C	0.2	—	V <sub>DD</sub> − 0.2	V	

Parameter	Symbol	Conditions	Min	Typ	Max	Units
Output Range	$V_{OUT(min,max)}$	$I_{OUT} = \pm 150 \mu A$	0.2	—	$V_{DD} - 0.2$	V
<b>Sign Comparator Parameters</b>						
Output Low Voltage	$V_{SIGN\_OL}$	$V_{DD} = 1.8 V, I_{SINK} = 35 \mu A$	—	—	0.2	V
Output High Voltage	$V_{SIGN\_OH}$	$V_{DD} = 1.8 V, I_{SOURCE} = 35 \mu A$	$V_{DD} - 0.2$	—	—	V
<b>Comparator</b>						
Input Bias Current	$I_{CIN\_BIAS}$	CIN-	—	0.3	—	nA
Input Bias Current	$I_{CIN+\_BIAS}$	CIN+	—	0.3	—	nA
Input referred DC offset	$V_{C\_OS}$	$-40^\circ C < T_A < +85^\circ C$	—	—	$\pm 4$	mV
Input Common Mode Range	$V_{C\_CM}$		0.4	—	$V_{DD}$	V
COOUT Output Range	$V_{COOUT(min,max)}$	$I_{COOUT} = \pm 500 \mu A; V_{DD} = 1.7 V$	0.4	—	$V_{DD} - 0.4$	V
CLATCH Input Voltage	CLATCH <sub>Lo</sub>	Low CMOS Logic Level	—	—	0.4	V
	CLATCH <sub>Hi</sub>	High CMOS Logic Level	$V_{DD} - 0.4$	—	—	V
<b>FET Control (TS1110 Only)</b>						
FET Leakage	$I_{FET\_Leakage}$	$T_A = +25^\circ C$	—	—	4.5	nA
FET Sourcing Current	$I_{FET\_Source(max)}$	$T_A = +25^\circ C$	—	3.2	17.4	mA
FET Internal On Resistance	$R_{FET\_ON}$	$T_A = +25^\circ C$	—	487	794	$\Omega$
<b>VREF Divider</b>						
VREF Activation voltage	$V_{REF(min)}$	VREF Rising edge	—	—	0.9	V
Resistor on VREF	$R_{VREF}$		—	9.2	—	M $\Omega$
VBIAS	$V_{VBIAS}$	$V_{REF} = 1 V$	0.495	0.5	0.505	V
<b>Note:</b>						
1. $RS+ = RS- = 3.6 V$ ; $V_{SENSE} = (V_{RS+} - V_{RS-}) = 0 V$ ; $V_{DD} = 3 V$ ; $V_{BIAS} = 1.5 V$ ; $CIN+ = 0.75 V$ ; $V_{REF} = GND$ ; $CLATCH = GND$ ; $R_{FET} = 1 M\Omega$ ; $FILT$ connected to $4 k\Omega$ and $470 nF$ in series to $GND$ . $T_A = T_J = -40^\circ C$ to $+85^\circ C$ unless otherwise noted. Typical values are at $T_A = +25^\circ C$ .						
2. Extrapolated to $V_{OUT} = V_{FILT}$ ; $I_{RS+} + I_{RS-}$ is the total current into the $RS+$ and the $RS-$ pins.						
3. Input offset voltage $V_{OS}$ is extrapolated from a $V_{OUT(+)}$ measurement with $V_{SENSE}$ set to $+1 mV$ and a $V_{OUT(-)}$ measurement with $V_{SENSE}$ set to $-1 mV$ ; average $V_{OS} = (V_{OUT(-)} - V_{OUT(+)}) / (2 \times GAIN)$ .						
4. Amplitude of $V_{SENSE}$ lower or higher than $V_{OS}$ required to cause the comparator to switch output states.						
5. Gain error is calculated by applying two values for $V_{SENSE}$ and then calculating the error of the actual slope vs. the ideal transfer characteristic. For $GAIN = 20 V/V$ , the applied $V_{SENSE}$ for $GE\pm$ is $\pm 25 mV$ and $\pm 60 mV$ . For $GAIN = 200 V/V$ , the applied $V_{SENSE}$ for $GE\pm$ is $\pm 2.5 mV$ and $\pm 6 mV$ .						

Table 3.3. AC Characteristics<sup>1</sup>

Parameter	Symbol	Conditions	Min	Typ	Max	Units	
<b>CSA Buffer</b>							
Output Settling time	$t_{OUT\_s}$	1% Final value, $V_{OUT} = 1.3\text{ V}$	Gain = 20 V/V	—	1.35	—	msec
<b>Sign Comparator</b>							
Propagation Delay	$t_{SIGN\_PD}$	$V_{SENSE} = \pm 1\text{ mV}$		—	3	—	msec
		$V_{SENSE} = \pm 10\text{ mV}$		—	0.4	—	msec
<b>Comparator</b>							
Rising Propagation Delay	$t_{C\_PDR}$	Overdrive = 10 mV, $C_{COUT} = 15\text{ pF}$		—	9	—	$\mu\text{s}$
Comparator Hysteresis	$V_{C\_HYS}$	CIN– falling		—	20	—	mV
<b>FET Control (TS1110 Only)</b>							
FET Turn ON Time	$T_{FET(ON)}$	See Note 2		—	0.255	—	$\mu\text{s}$
<b>Note:</b>							
1. $RS+ = RS- = 3.6\text{ V}$ , $V_{SENSE} = (V_{RS+} - V_{RS-}) = 0\text{ V}$ , $VDD = 3\text{ V}$ , $VBIAS = 1.5\text{ V}$ . $T_A = T_J = -40\text{ }^\circ\text{C}$ to $+85\text{ }^\circ\text{C}$ unless otherwise noted. Typical values are at $T_A = +25\text{ }^\circ\text{C}$ .							
2. Delay after comparator is triggered. Refer to FET ON Time vs. Gate Capacitance graph.							

Table 3.4. Thermal Conditions

Parameter	Symbol	Conditions	Min	Typ	Max	Units
Operating Temperature Range	$T_{OP}$		–40	—	+85	$^\circ\text{C}$

**Table 3.5. Absolute Maximum Limits**

Parameter	Symbol	Conditions	Min	Typ	Max	Units
RS+ Voltage	$V_{RS+}$		-0.3	—	27	V
RS- Voltage	$V_{RS-}$		-0.3	—	27	V
FET Voltage (TS1110 Only)	$V_{FET}$		-0.3	—	27	V
Supply Voltage	VDD		-0.3	—	6	V
OUT Voltage	$V_{OUT}$		-0.3	—	6	V
SIGN Voltage	$V_{SIGN}$		-0.3	—	6	V
FILT Voltage	$V_{FILT}$		-0.3	—	6	V
CLATCH Voltage	$V_{CLATCH}$		-0.3	—	6	V
COUT Voltage	$V_{COUT}$		-0.3	—	6	V
VREF Voltage	$V_{VREF}$		-0.3	—	6	V
CIN+ Voltage	$V_{CIN+}$		-0.3	—	VDD + 0.3	V
CIN- Voltage	$V_{CIN-}$		-0.3	—	VDD + 0.3	V
VBIAS Voltage	$V_{VBIAS}$		-0.3	—	VDD + 0.3	V
RS+ to RS- Voltage	$V_{RS+} - V_{RS-}$		—	—	27	V
Short Circuit Duration: OUT to GND			—	—	Continuous	
Continuous Input Current (Any Pin)			-20	—	20	mA
Junction Temperature			—	—	150	°C
Storage Temperature Range			-65	—	150	°C
Lead Temperature (Soldering, 10 s)			—	—	300	°C
Soldering Temperature (Reflow)			—	—	260	°C
<b>ESD Tolerance</b>						
Human Body Model			—	—	2000	V
Machine Model			—	—	200	V

For the following graphs,  $V_{RS+} = V_{RS-} = 3.6\text{ V}$ ;  $V_{DD} = 3\text{ V}$ ;  $V_{REF} = \text{GND}$ ;  $V_{BIAS} = 1.5\text{ V}$ ,  $C_{IN+} = 0.75\text{ V}$ ,  $CLATCH = V_{DD}$ ,  $C_{IN-} = \text{OUT}$ ,  $R_{FET} = 1\text{ M}\Omega$ ,  $C_{FET} = 820\text{ pF}$ , and  $T_A = +25\text{ C}$  unless otherwise noted.

Positive Gain Error Histogram

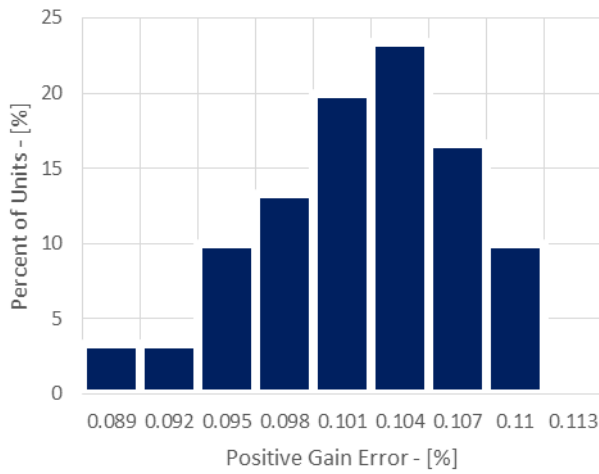

Negative Gain Error Histogram

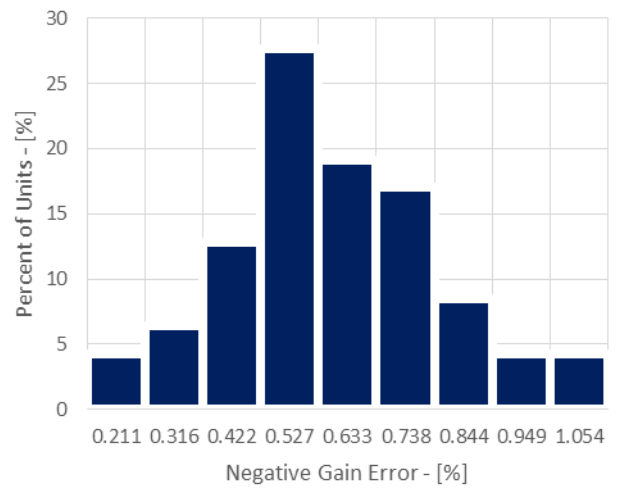

CSA Input Offset Voltage Histogram

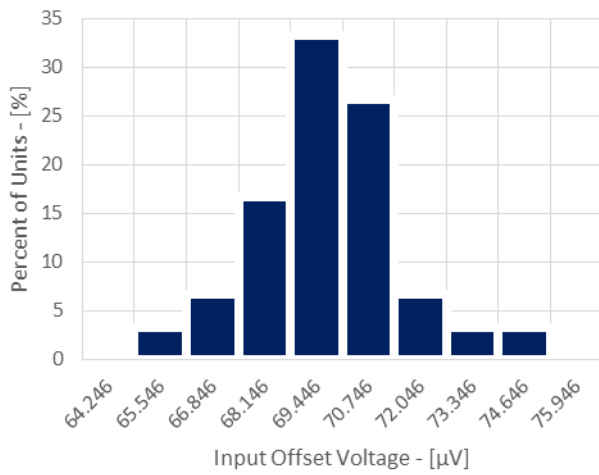

CSA Input Offset vs Common Mode Voltage

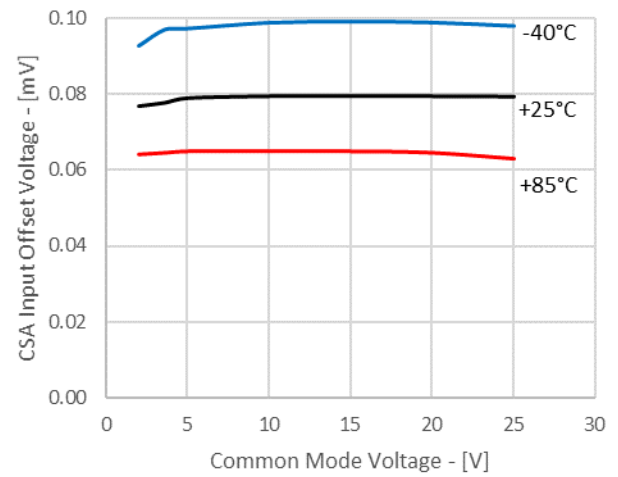

CSA Supply Current vs Common Mode Voltage

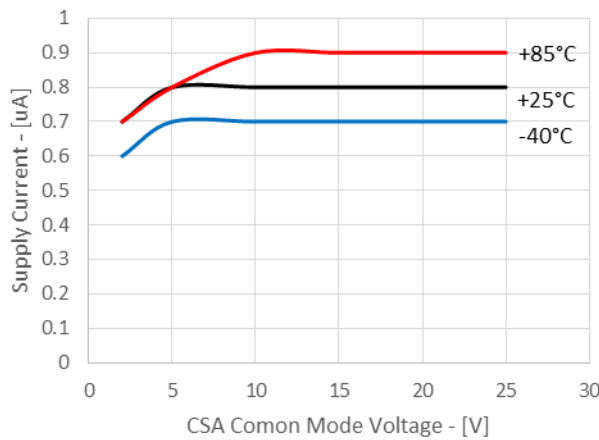

Supply Current vs VDD

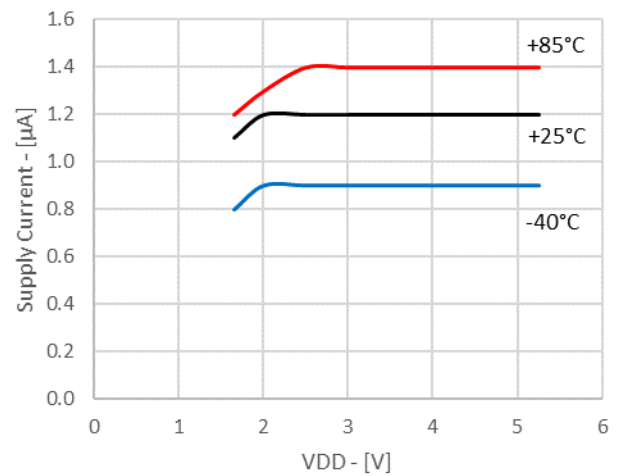

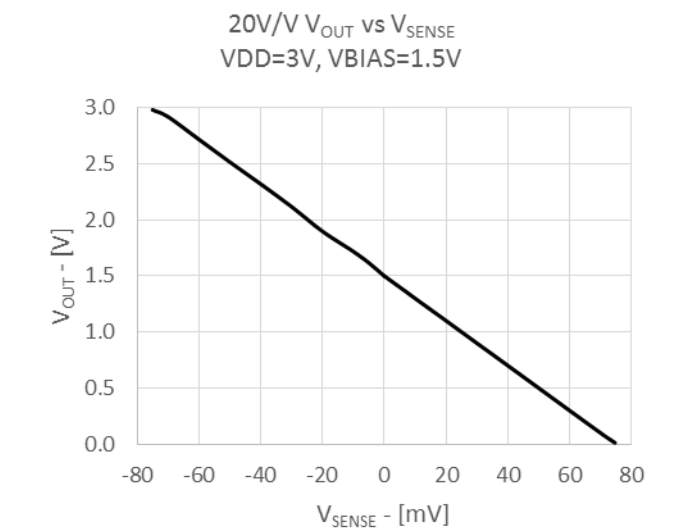
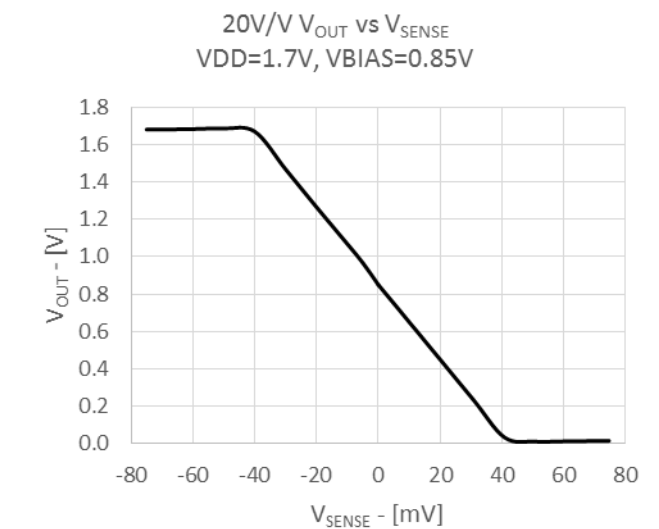
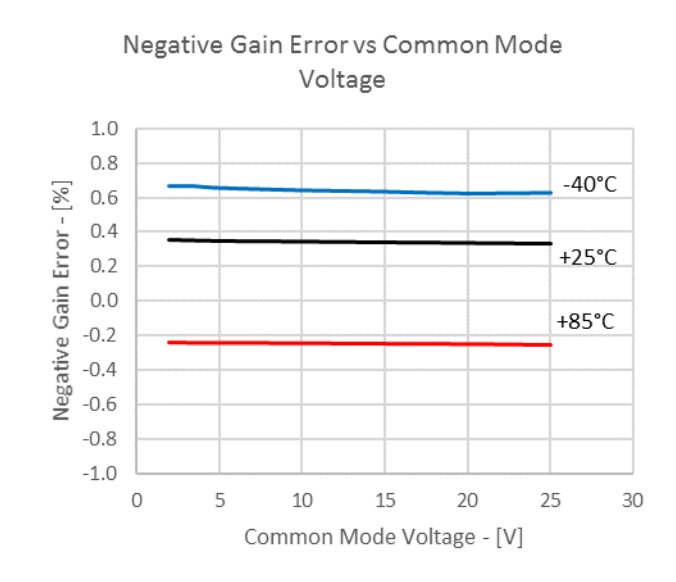
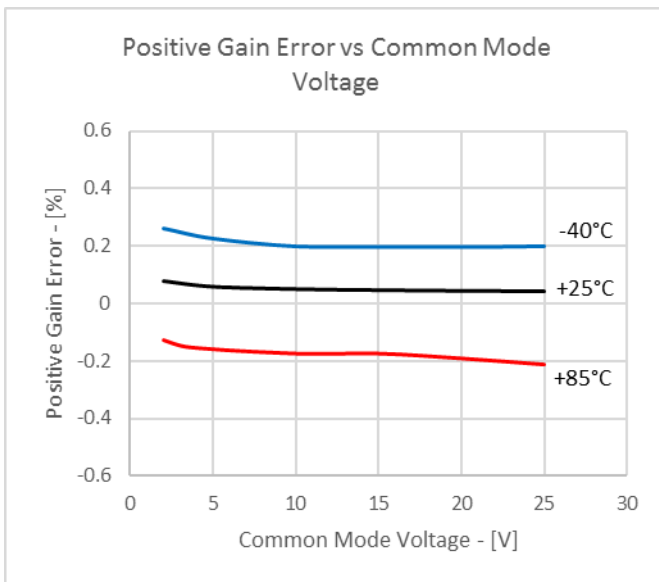
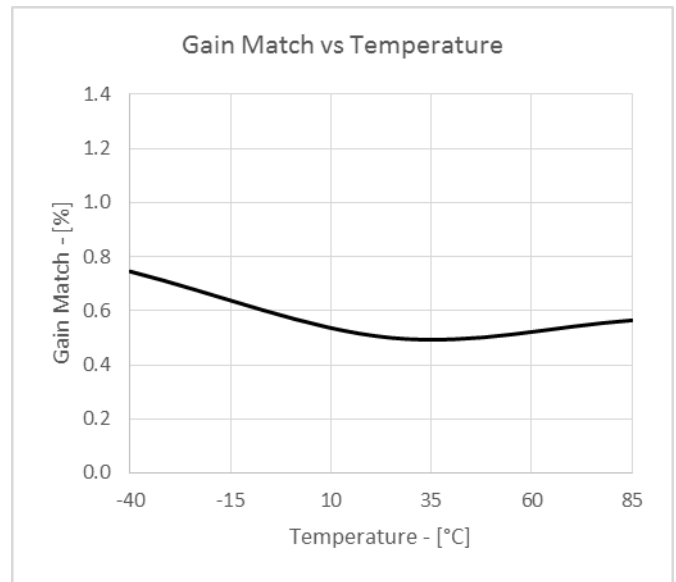
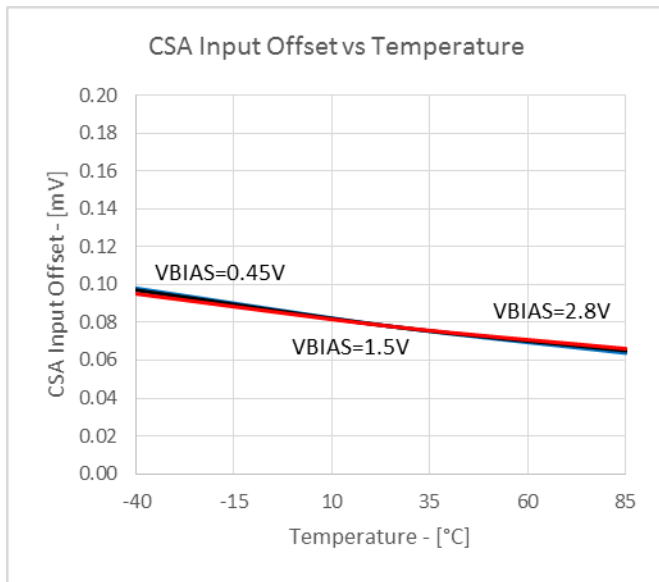

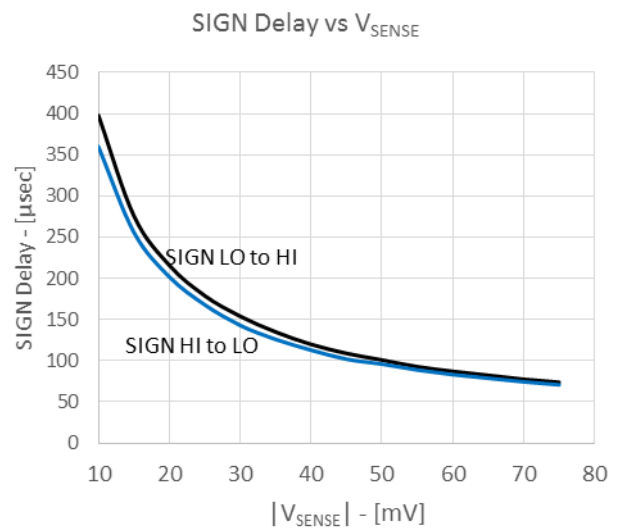
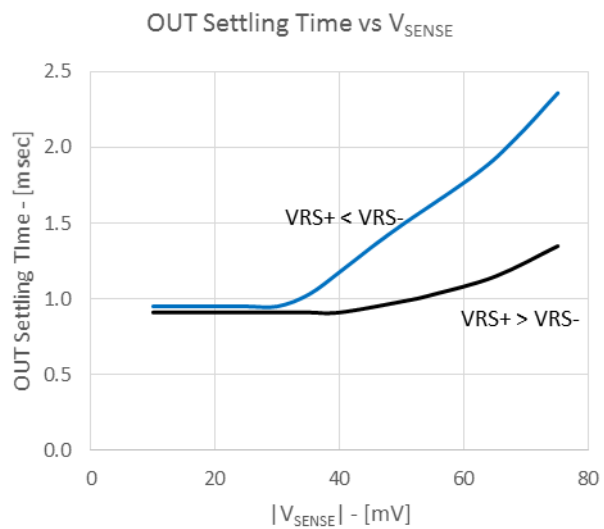
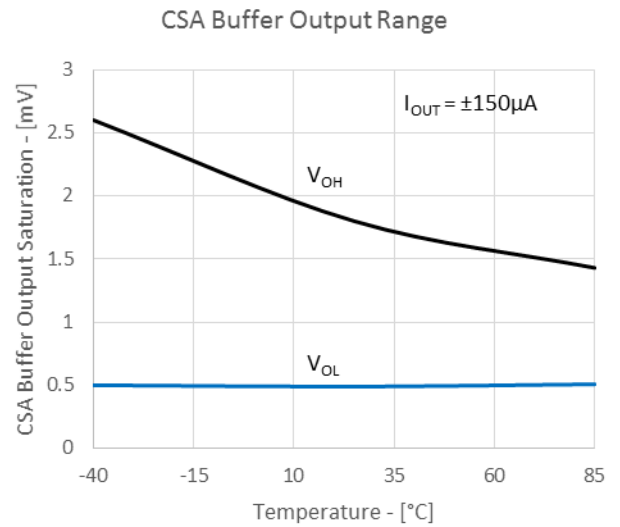
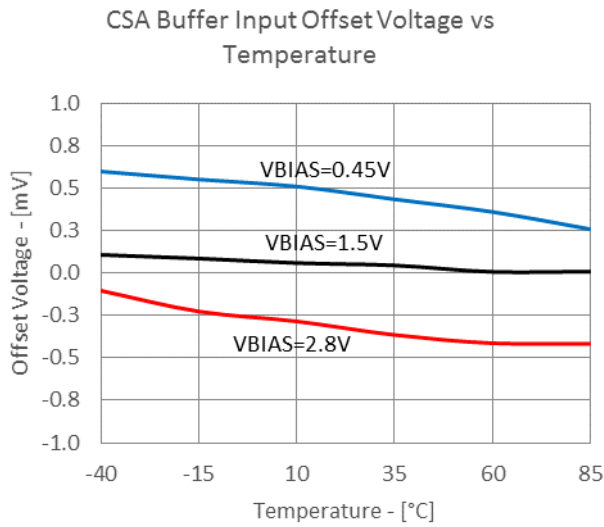
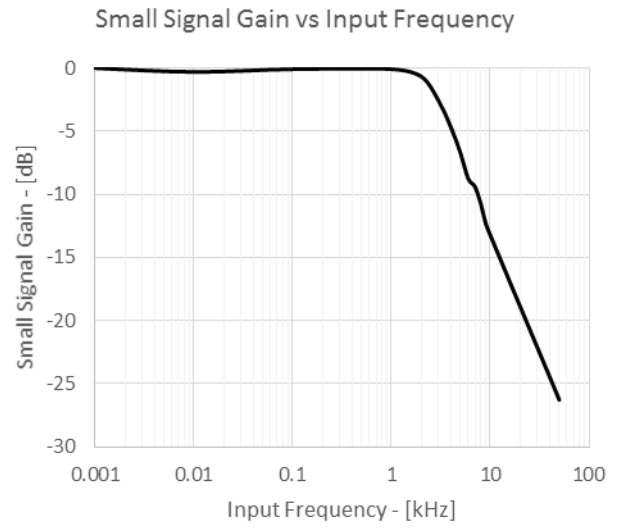
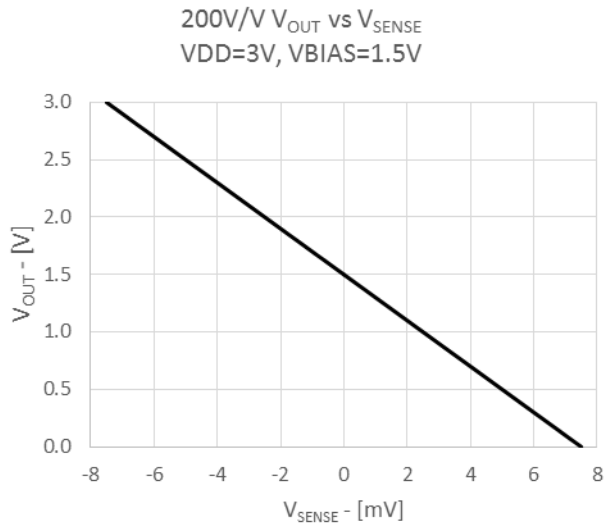

Current Limit Delay vs Overdrive

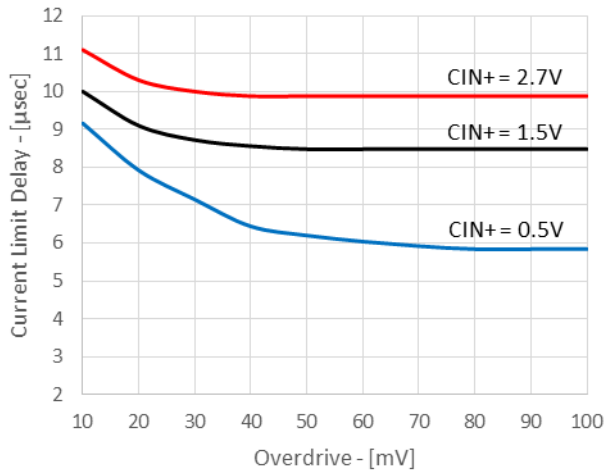

Current Limit Delay vs Capacitive Load

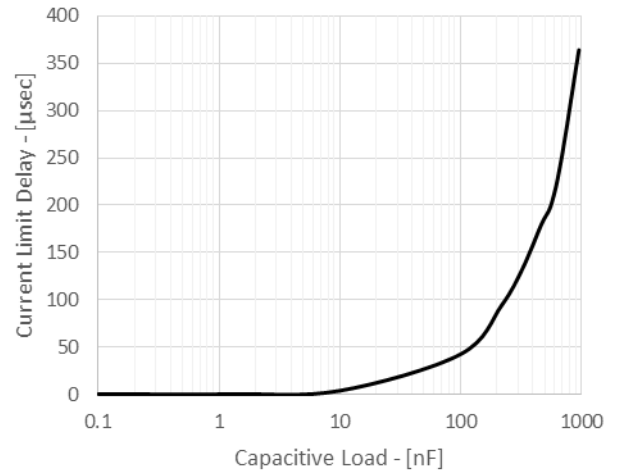

FET ON Time vs Gate Capacitance

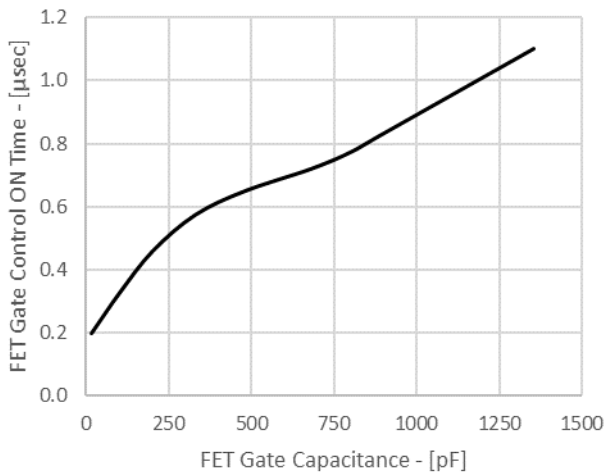

FET OFF Time vs Gate Capacitance

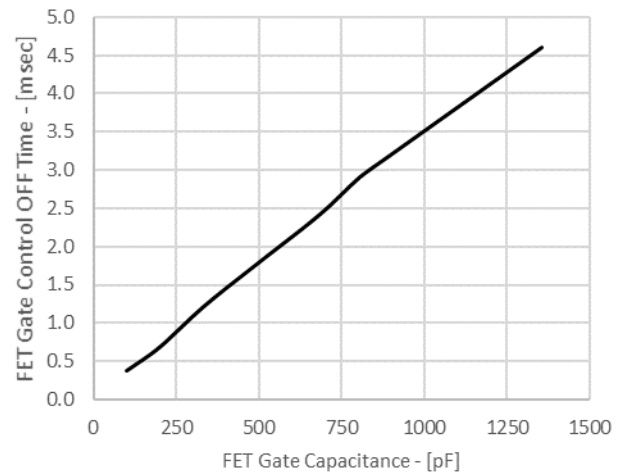

VBIAS Variation Over Temperature

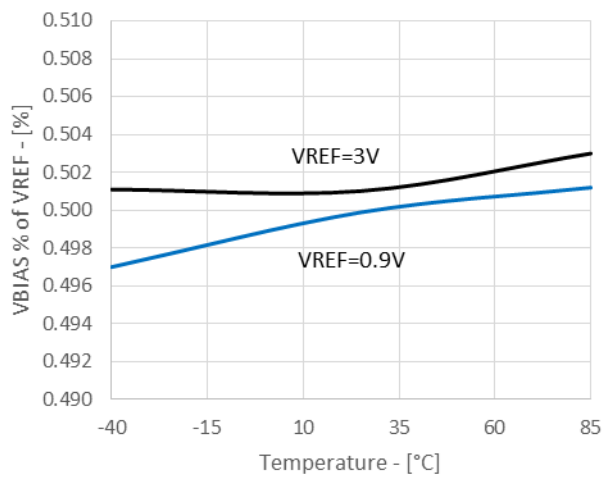

Small Signal Pulse Response

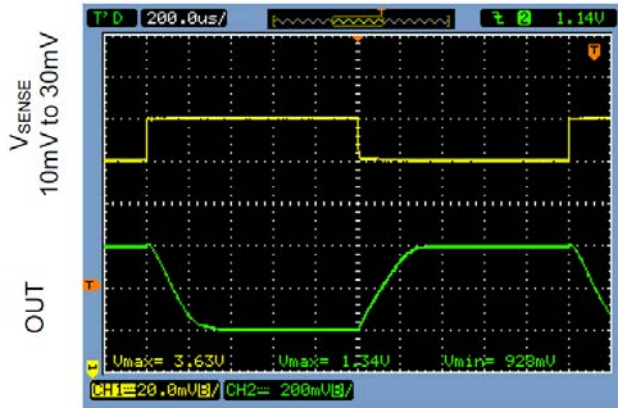

Large Signal Pulse Response

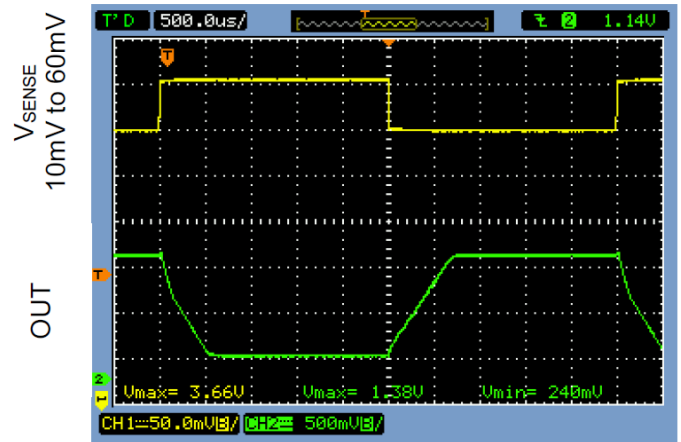

Circuit Breaker with Current Limiter  
VBIAS=1.5V, CIN+=0.75V

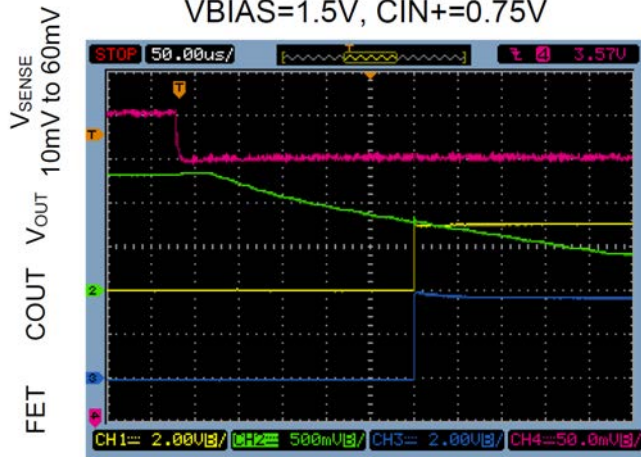

Current Limiter Falling Edge  
VBIAS=1.5V, CIN+=0.75V

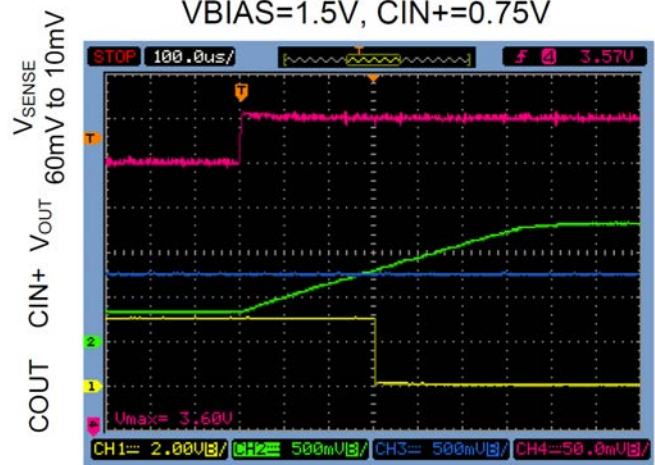

FET Gate Control ON Time  
VBIAS=1.5V, CIN+=0.75V, CFET=820pF

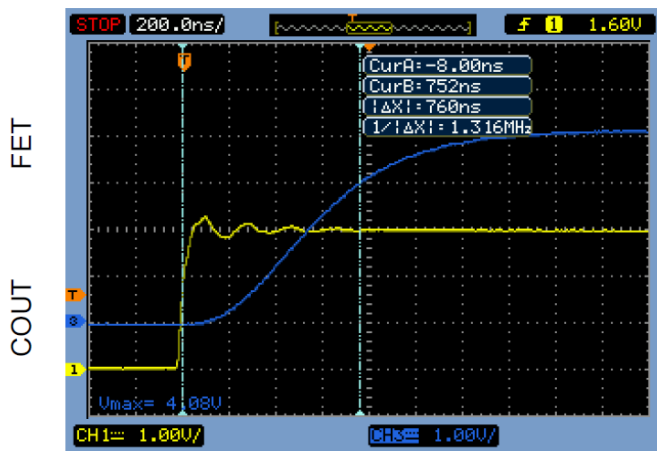

FET Gate Control OFF Time  
VBIAS=1.5V, CIN+=0.75V, CFET=820pF

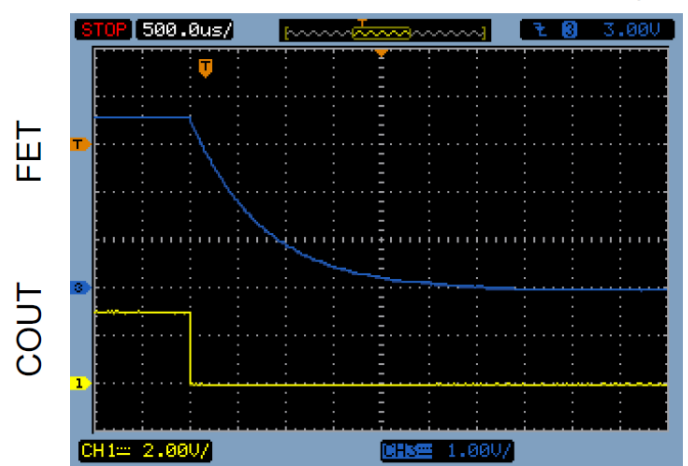



## 5. Pin Descriptions

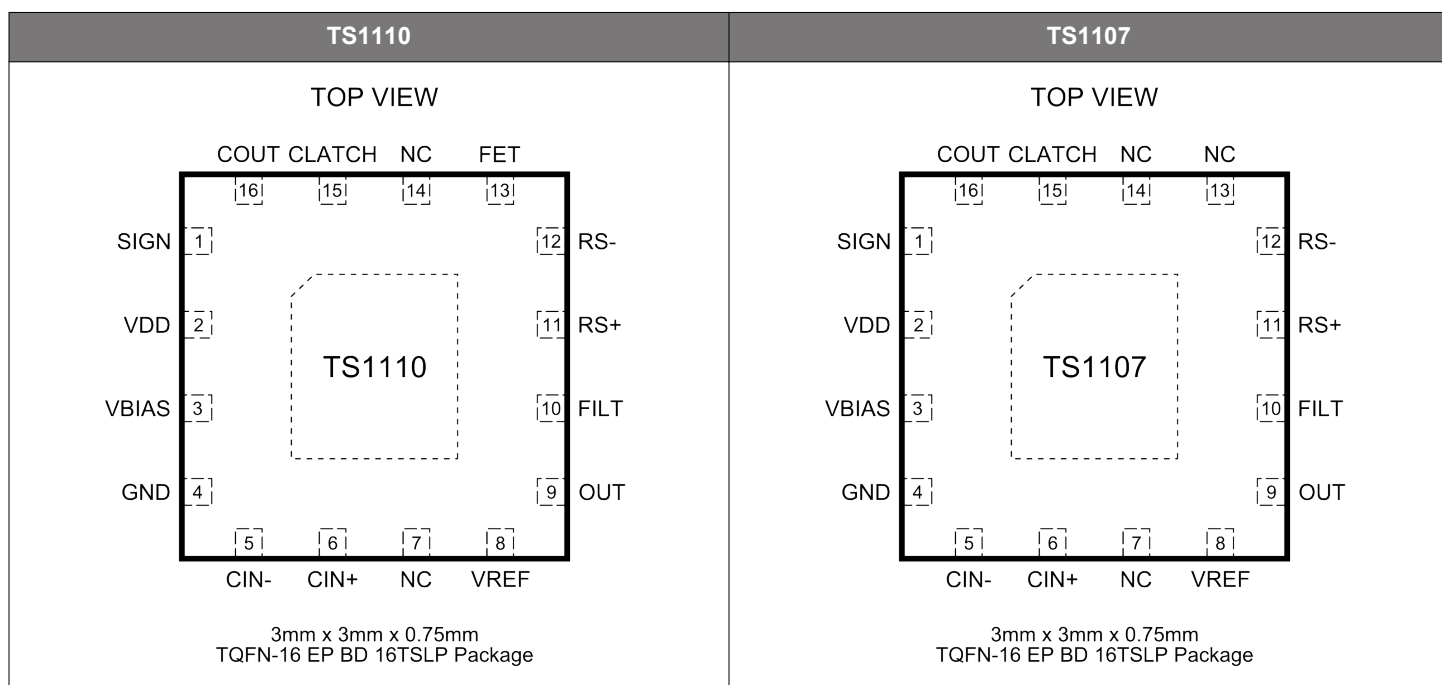

**Table 5.1. Pin Descriptions**

Pin	Label	Function
1	SIGN	Sign output. SIGN is HIGH for $V_{RS+} > V_{RS-}$ and LOW for $V_{RS-} > V_{RS+}$ .
2	VDD	External power supply pin. Connect this to the system's VDD supply.
3	VBIAS	Bias voltage for CSA output. When VREF is activated, leave open.
4	GND	Ground. Connect to analog ground.
5	CIN-	Inverting terminal of Current Limiter Comparator. Connect to OUT.
6	CIN+	Non-inverting terminal of Current Limiter Comparator. Connect an external reference voltage to set current limit.
7	NC	No connection. Leave open.
8	VREF	Voltage reference. To activate, a minimum voltage of 0.9V is required. To disable voltage divider, connect to analog ground, GND.
9	OUT	CSA buffered output. Connect to CIN-.
10	FILT	Inverting terminal of CSA Buffer. Connect a series RC Filter of 4k $\Omega$ and 0.47 $\mu$ F, otherwise leave open.
11	RS+	External Sense Resistor Power-Side Connection
12	RS-	External Sense Resistor Load-Side Connection. For TS1110 only, connect external PFET's source to RS- pin and connect load to PFET's drain. For TS1107, connect load directly to RS- pin.
13	FET	TS1110 External PFET Gate Connection. Connect an external pull-down resistor of 1M $\Omega$ .
	NC	TS1107 No connection. Leave open.
14	NC	No connection. Leave open.
15	CLATCH	Current Limiter Comparator Latch Enable. CLATCH must be HIGH for latch enable. To disable latch, CLATCH must be held LOW.
16	COUT	Current Limiter Comparator Output.
Exposed Pad	EPAD	Exposed backside paddle. For best electrical and thermal performance, solder to analog ground.

## 6. Packaging

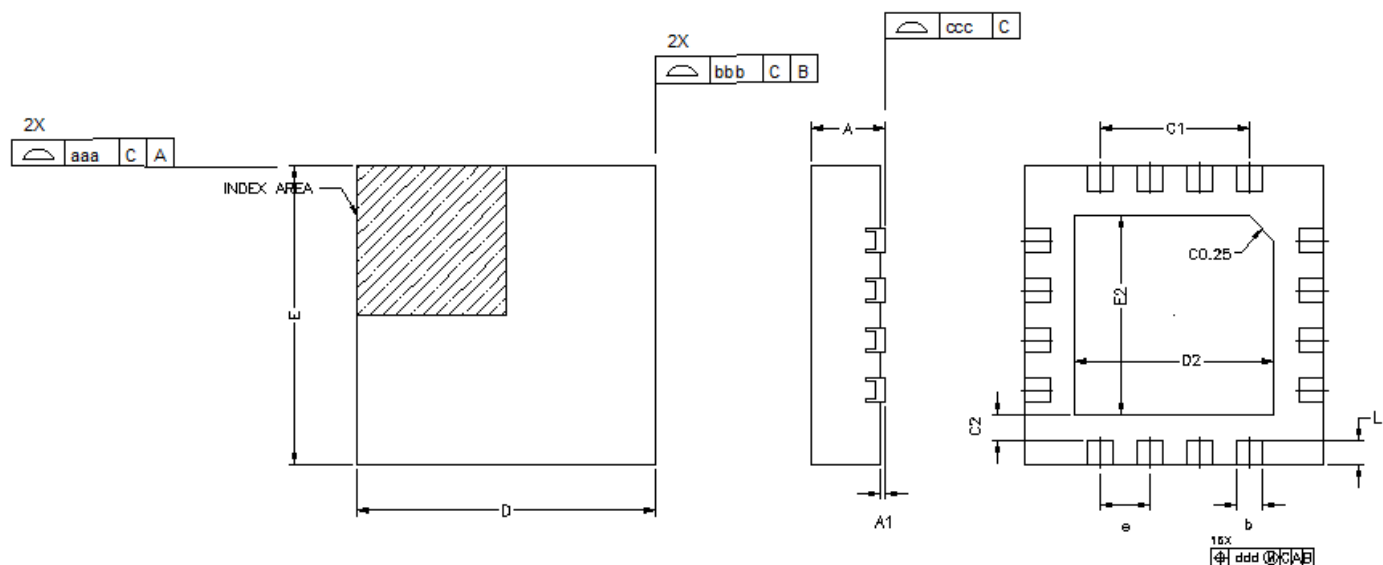

Figure 6.1. TS1107/10 3x3 mm 16-QFN Package Diagram

Table 6.1. Package Dimensions

Dimension	Min	Nom	Max
A	0.70	0.75	0.80
A1	0.00	0.02	0.05
b	0.20	0.25	0.30
C1	1.50 REF		
C2	0.25 REF		
D	3.00 BSC		
D2	1.90	2.00	2.10
e	0.50 BSC		
E	3.00 BSC		
E2	1.90	2.00	2.10
L	0.20	0.25	0.30
aaa	—	—	0.05
bbb	—	—	0.05
ccc	—	—	0.05
ddd	—	—	0.10

**Note:**

1. All dimensions shown are in millimeters (mm) unless otherwise noted.
2. Dimensioning and Tolerancing per ANSI Y14.5M-1994.

## 7. Top Marking

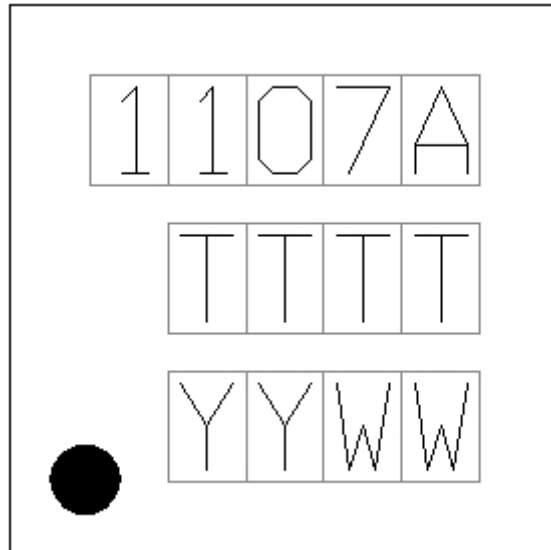
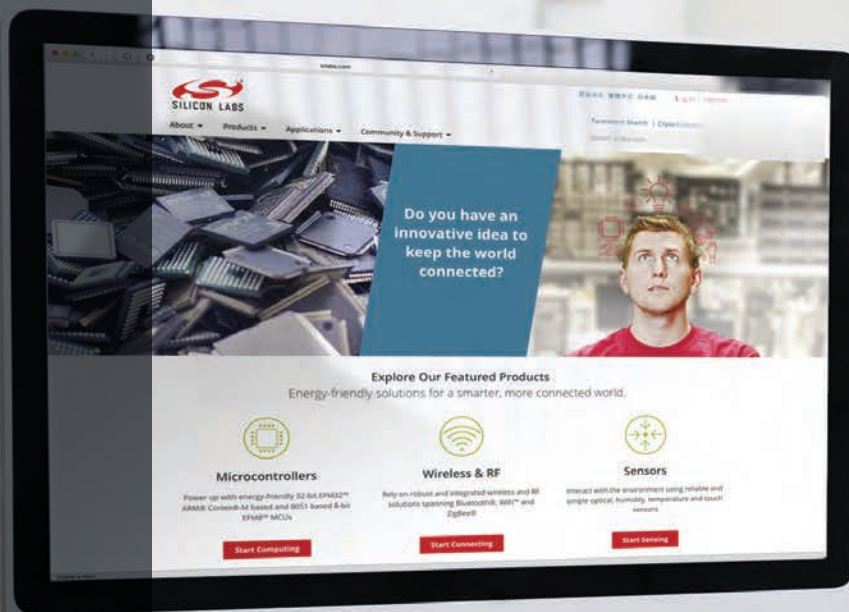

**Figure 7.1. Top Marking**

**Table 7.1. Top Marking Explanation**

Mark Method	Laser	
Pin 1 Mark:	Circle = 0.50 mm Diameter (lower left corner)	
Font Size:	0.50 mm (20 mils)	
Line 1 Mark Format:	Product ID	Note: A = 20 gain, B = 200 gain
Line 2 Mark Format:	TTTT – Mfg Code	Manufacturing code
Line 3 Mark Format:	YY = Year; WW = Work Week	Year and week of assembly

<b>1. Ordering Information</b>	<b>1</b>
<b>2. System Overview</b>	<b>2</b>
2.1 Functional Block Diagrams	2
2.2 Current Sense Amplifier + Output Buffer	3
2.3 Sign Output	4
2.4 Current Limit Comparator	4
2.5 FET Control (TS1110 Only)	4
2.6 VREF Divider	4
2.7 Selecting a Sense Resistor	5
2.7.1 RSENSE Voltage Loss	5
2.7.2 VOUT Swing vs. Desired VSENSE and Applied Supply Voltage at VDD.	5
2.7.3 Total Load Current Accuracy	5
2.7.4 Circuit Efficiency and Power Dissipation	5
2.7.5 RSENSE Kelvin Connections	6
2.7.6 RSENSE Composition	6
2.7.7 Internal Noise Filter	6
2.7.8 PC Board Layout and Power-Supply Bypassing	6
<b>3. Electrical Characteristics</b>	<b>7</b>
<b>4. Typical Application Circuit</b>	<b>16</b>
<b>5. Pin Descriptions</b>	<b>17</b>
<b>6. Packaging</b>	<b>18</b>
<b>7. Top Marking</b>	<b>19</b>



Smart.  
Connected.  
Energy-Friendly



**Products**  
[www.silabs.com/products](http://www.silabs.com/products)

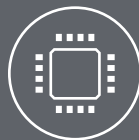

**Quality**  
[www.silabs.com/quality](http://www.silabs.com/quality)



**Support and Community**  
[community.silabs.com](http://community.silabs.com)

#### Disclaimer

Silicon Laboratories intends to provide customers with the latest, accurate, and in-depth documentation of all peripherals and modules available for system and software implementers using or intending to use the Silicon Laboratories products. Characterization data, available modules and peripherals, memory sizes and memory addresses refer to each specific device, and "Typical" parameters provided can and do vary in different applications. Application examples described herein are for illustrative purposes only. Silicon Laboratories reserves the right to make changes without further notice and limitation to product information, specifications, and descriptions herein, and does not give warranties as to the accuracy or completeness of the included information. Silicon Laboratories shall have no liability for the consequences of use of the information supplied herein. This document does not imply or express copyright licenses granted hereunder to design or fabricate any integrated circuits. The products must not be used within any Life Support System without the specific written consent of Silicon Laboratories. A "Life Support System" is any product or system intended to support or sustain life and/or health, which, if it fails, can be reasonably expected to result in significant personal injury or death. Silicon Laboratories products are generally not intended for military applications. Silicon Laboratories products shall under no circumstances be used in weapons of mass destruction including (but not limited to) nuclear, biological or chemical weapons, or missiles capable of delivering such weapons.

#### Trademark Information

Silicon Laboratories Inc., Silicon Laboratories, Silicon Labs, SiLabs and the Silicon Labs logo, CMEMS®, EFM, EFM32, EFR, Energy Micro, Energy Micro logo and combinations thereof, "the world's most energy friendly microcontrollers", Ember®, EZLink®, EZMac®, EZRadio®, EZRadioPRO®, DSPLL®, ISOmodem®, Precision32®, ProSLIC®, SiPHY®, USBXpress® and others are trademarks or registered trademarks of Silicon Laboratories Inc. ARM, CORTEX, Cortex-M3 and THUMB are trademarks or registered trademarks of ARM Holdings. Keil is a registered trademark of ARM Limited. All other products or brand names mentioned herein are trademarks of their respective holders.





Silicon Laboratories Inc.  
400 West Cesar Chavez  
Austin, TX 78701  
USA

<http://www.silabs.com>

## Looking for pricing, stock, or lifecycle information?

Click below to explore more details on WIN SOURCE:

-  [View TS1107-200ITQ1633T on WIN SOURCE](#)
-  [Silicon Labs](#) Information

## Optimize Your Supply Chain with WIN SOURCE Solutions

-  Global Sourcing Solution
-  Obsolete Management
-  Cost Control Management
-  Shortage Management
-  Alternative Solution
-  Excess Inventory Management