



**THE DATASHEET OF
AP22652AW6-7**



Description

The AP22652, AP22653, AP22652A, and AP22653A are single-channel, precision-adjustable, current-limited switches optimized for applications that require precision current limiting, or to provide up to 2.1A of continuous load current during heavy loads/short circuits. These devices offer a programmable current-limit threshold between 125mA and 2665mA (typ) via an external resistor. Current-limit accuracy $\pm 10\%$ can be achieved at high current-limit settings. The rise and fall times are controlled to minimize current surges during turn on/off.

The devices have fast short-circuit response time for improved overall system robustness. They provide a complete protection solution for applications subject to heavy capacitive loads and the prospect of short circuit, offering reverse-current blocking and limiting, overcurrent, overtemperature, and short-circuit protection, as well as controlled rise time and undervoltage lockout functionality. A 6ms deglitch capability on the open-drain flag output prevents false overcurrent reporting and does not require any external components.

The AP22652 and AP22653 limit the output current to a safe level when the output current exceeds current-limit threshold.

The AP22652A and AP22653A provide latch-off function during overcurrent or reverse-voltage conditions.

All devices are available in SOT26 (Type A1) and W-DFN2020-6 (Type A1) packages.

Applications

- Set-Top Boxes
- LCD TVs & Monitors
- Residential Gateways
- Laptops, Desktops, Servers, e-Readers, Printers, Docking Stations, HUBs

Pin Assignments

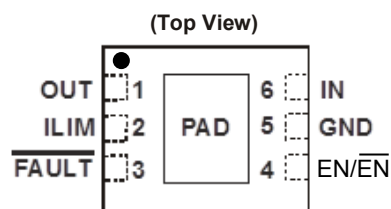

W-DFN2020-6 (Type A1)

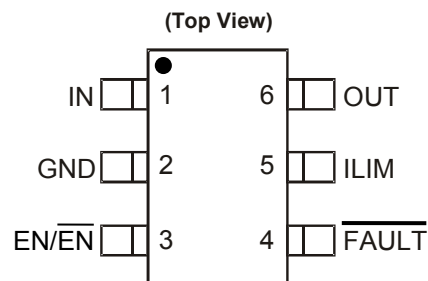

SOT26 (Type A1)

Features

- Up to 2.1A Maximum Load Current
- Accurate Adjustable Current Limit, 125mA to 2665mA
- $\pm 7\%$ Accurate Adjustable Current Limit, 1.735A with $R_{LIM} = 15k\Omega$
- Constant-Current (AP22652/53) During Overcurrent
- Output Latch-Off (AP22652A/53A) at Overcurrent
- Fast Short-Circuit Response Time: 5 μ s (typ)
- Reverse Current Blocking During Shutdown and Reverse Current Limiting During Enable
- Operating Range: 3.0V to 5.5V
- Built-In Soft-Start with 0.5ms Typical Rise Time
- Overcurrent, Output Overvoltage, and Thermal Protection
- Fault Report (FAULT) with Blanking Time
- ESD Protection: 2kV HBM, 500V CDM
- 15kV ESD Protection per IEC61000-4-2 (With External Capacitance)
- UL Recognized, File Number E322375, Vol. 1
- IEC60950-1 CB Scheme Certified
- Active-Low (AP22652/52A) or Active-High (AP22653/53A) Enable
- Ambient Temperature Range: -40°C to $+85^{\circ}\text{C}$
- SOT26 (Type A1) and W-DFN2020-6 (Type A1) Packages: Available in "Green" Molding Compound (No Br, Sb)
- **Totally Lead-Free & Fully RoHS Compliant (Notes 1 & 2)**
- **Halogen and Antimony Free. "Green" Device (Note 3)**
- **For automotive applications requiring specific change control (i.e. parts qualified to AEC-Q100/101/200, PPAP capable, and manufactured in IATF 16949 certified facilities), please [contact us](mailto:contact@diodes.com) or your local Diodes representative.**
<https://www.diodes.com/quality/product-definitions/>

Notes: 1. No purposely added lead. Fully EU Directive 2002/95/EC (RoHS), 2011/65/EU (RoHS 2) & 2015/863/EU (RoHS 3) compliant.
2. See <https://www.diodes.com/quality/lead-free/> for more information about Diodes Incorporated's definitions of Halogen- and Antimony-free, "Green" and Lead-free.
3. Halogen- and Antimony-free "Green" products are defined as those which contain <900ppm bromine, <900ppm chlorine (<1500ppm total Br + Cl) and <1000ppm antimony compounds.

Typical Applications Circuit (Note 4)

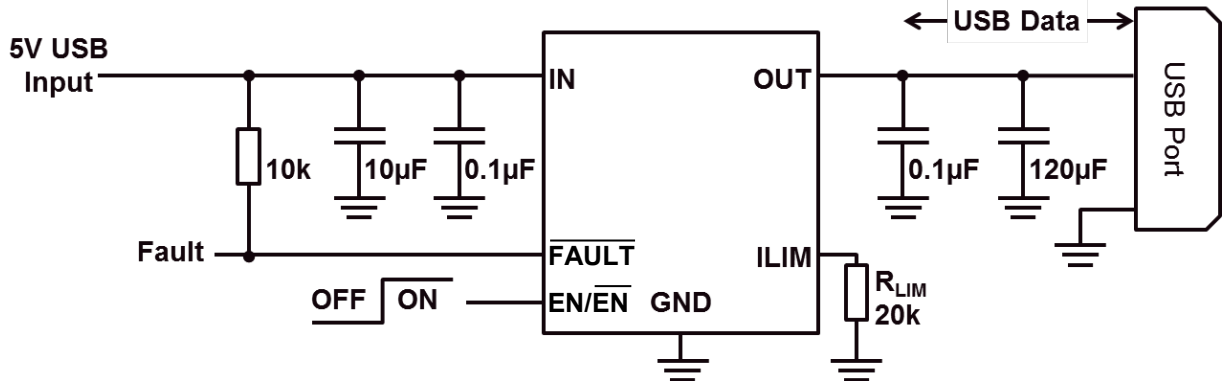

Note: 4. 120µF output capacitance is a requirement of USB.

Available Options

Part Number	Channel	Enable Pin (EN/EN)	Recommended Maximum Continuous Load Current (A)	Current-Limit Protection	Package
AP22652	1	Active Low	2.1	Constant-Current	W-DFN2020-6 (Type A1)
AP22653	1	Active High			W-DFN2020-6 (Type A1)
AP22652	1	Active Low			SOT26 (Type A1)
AP22653	1	Active High			SOT26 (Type A1)
AP22652A	1	Active Low		Latch-Off	W-DFN2020-6 (Type A1)
AP22653A	1	Active High			W-DFN2020-6 (Type A1)
AP22652A	1	Active Low			SOT26 (Type A1)
AP22653A	1	Active High			SOT26 (Type A1)

Pin Descriptions

Pin Name	Pin Number				I/O	Function
	AP22652W6-7 AP22652AW6-7	AP22653W6-7 AP22653AW6-7	AP22652FDZ-7 AP22652AFDZ-7	AP22653FDZ-7 AP22653AFDZ-7		
IN	1	1	6	6	I	Input, connect a 0.1µF or greater ceramic capacitor from IN to GND as close to IC as possible.
GND	2	2	5	5	—	Ground, connect to external exposed pad.
EN	3	—	4	—	I	Enable input, logic low turns on power switch.
EN	—	3	—	4	I	Enable input, logic high turns on power switch.
FAULT	4	4	3	3	O	Active-low open-drain output, asserted during over-current, over-temperature, or reverse-voltage conditions.
ILIM	5	5	2	2	O	Use external resistor to set current-limit threshold; recommended $10k\Omega \leq R_{LIM} \leq 210k\Omega$
OUT	6	6	1	1	O	Voltage Output Pin, connect a 0.1µF bypass capacitor and a high-value capacitor to GND, close to IC. (At least 10µF in USB application.)
Exposed Pad	—	—	Pad	Pad	—	Internal connection to GND; Connect to GND externally for improved power dissipation. It should not be used as electrical ground conduction path.

Functional Block Diagram

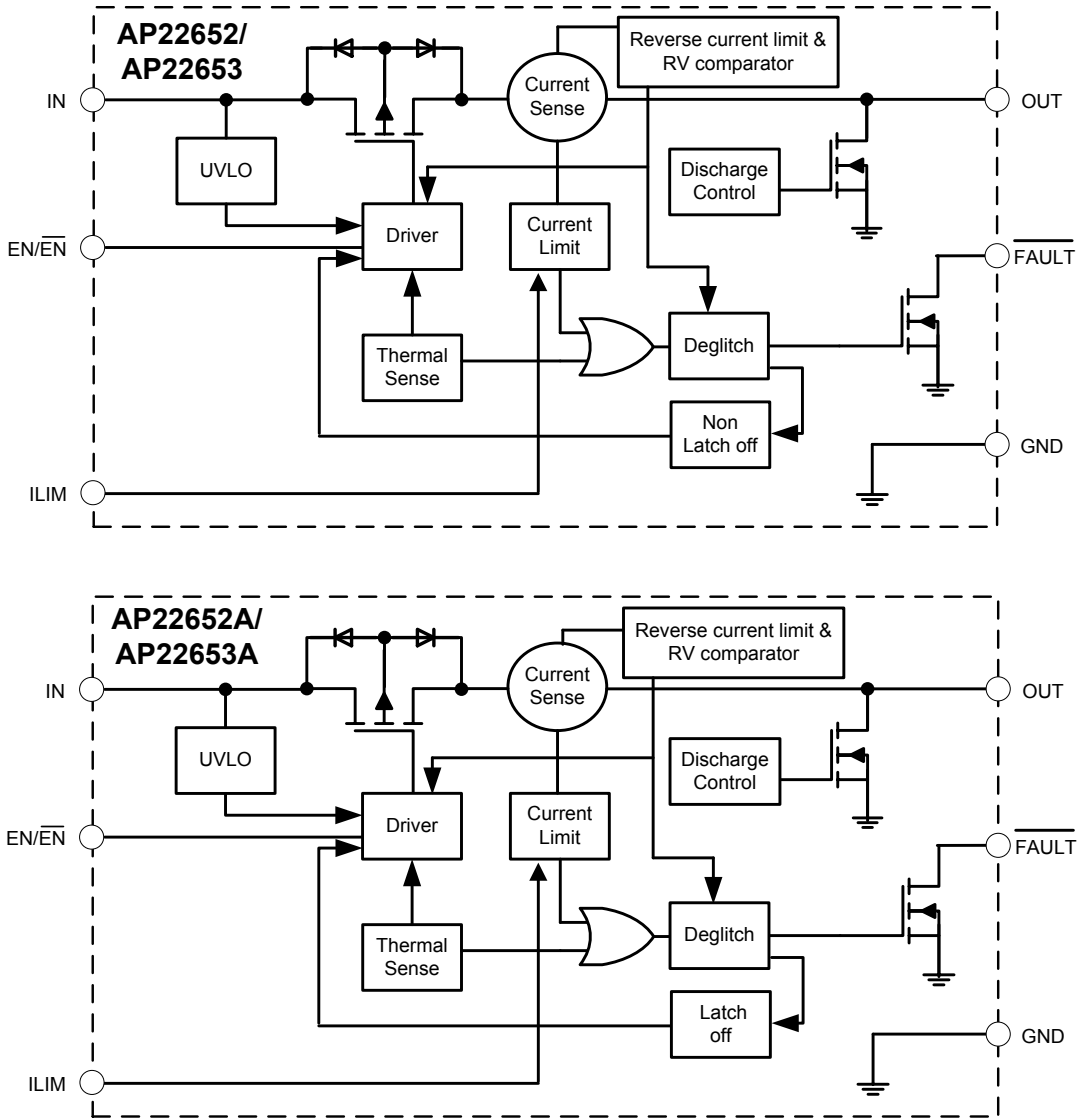

Absolute Maximum Ratings (@ T_A = +25°C, unless otherwise specified.)

Symbol	Parameter	Ratings	Unit	
ESD	HBM	Human Body Model ESD Protection	2	kV
	CDM	Charged Device Model ESD Protection	500	V
	IEC System Level	Surges per IEC61000-4-2. 1999 Applied to Output Terminals of EVM (Note 6)	15	kV
V _{IN} , V _{OUT} , V _{FAULT} , V _{ILIM} , V _{EN} , V _{EN}	Voltage on IN, OUT, FAULT, ILIM, EN, EN	-0.3 to +6.0	V	
—	Continuous FAULT Sink Current	25	mA	
—	ILIM Source Current	1	mA	
I _{LOAD}	Maximum Continuous Load Current	Internal Limited	A	
T _{J(MAX)}	Maximum Junction Temperature	-40 to +150	°C	
T _{STG}	Storage Temperature Range (Note 5)	-65 to +150	°C	

- Notes: 5. UL Recognized Rating from -30°C to +70°C (Diodes Incorporated qualified T_{STG} from -65°C to +150°C).
6. External capacitors need to be connected to the output, EVM board was tested with external capacitor. This level is a pass test only and not a limit.

Caution: Stresses greater than the 'Absolute Maximum Ratings' specified above, can cause permanent damage to the device. These are stress ratings only; functional operation of the device at these or any other conditions exceeding those indicated in this specification is not implied. Device reliability can be affected by exposure to absolute maximum rating conditions for extended periods of time. Semiconductor devices are ESD sensitive and can be damaged by exposure to ESD events. Suitable ESD precautions should be taken when handling and transporting these devices.

Dissipation Rating Table

Board	Package	Thermal Resistance θ _{JA}	Thermal Resistance θ _{JC}	T _A ≤ +25°C Power Rating	Derating Factor Above T _A = +25°C	T _A = +70°C Power Rating	T _A = +85°C Power Rating
High-K (Note 7)	W6	120°C/W	35°C/W	830mW	8.3mW/°C	450mW	330mW
High-K (Note 7)	FDZ	95°C/W	25°C/W	1050mW	10.05mW/°C	570mW	420mW

Note: 7. The JEDEC high-K (2s2p) board used to derive this data was a 3inch x 3inch, multilayer board with 1oz internal power and ground planes with 2oz copper traces on top and bottom of the board.

Recommended Operating Conditions (@ T_A = +25°C, unless otherwise specified.)

Symbol	Parameter	Min	Max	Unit
V _{IN}	Input Voltage	3	5.5	V
I _{OUT}	Continuous Output Current (-40°C ≤ T _A ≤ +85°C)	0	2.1	A
V _{EN} , V _{EN}	Enable Voltage	0	5.5	V
V _{IH}	High-Level Input Voltage on EN or EN	1.5	V _{IN}	V
V _{IL}	Low-Level Input Voltage on EN or EN	0	0.4	V
R _{LIM}	Current-Limit Threshold Resistor Range (1% Initial Tolerance)	10	210	kΩ
I _O	Continuous FAULT Sink Current	0	10	mA
—	Input De-Coupling Capacitance, IN to GND	0.1	—	μF
T _A	Operating Ambient Temperature	-40	+85	°C
T _J	Operating Junction Temperature	-40	+125	°C

Electrical Characteristics (@ $T_A = +25^\circ\text{C}$, $V_{IN} = 3.0\text{V}$ to 5.5V , $V_{EN} = 0\text{V}$ or $V_{EN} = V_{IN}$, $R_{FAULT} = 10\text{k}\Omega$, unless otherwise specified.)

Symbol	Parameter	Test Conditions (Note 8)	Min	Typ	Max	Unit	
Supply							
V_{UVLO}	Input UVLO	V_{IN} Rising	—	2.65	2.95	V	
ΔV_{UVLO}	Input UVLO Hysteresis	V_{IN} Decreasing	—	65	—	mV	
I_{SHDN}	Input Shutdown Current	$V_{IN} = 5.5\text{V}$, Disabled, OUT = Open	—	0.1	1	μA	
I_Q	Input Quiescent Current	$V_{IN} = 5.5\text{V}$, Enabled, OUT = Open, $R_{LIM} = 20\text{k}\Omega$	—	140	160	μA	
		$V_{IN} = 5.5\text{V}$, Enabled, OUT = Open, $R_{LIM} = 210\text{k}\Omega$	—	120	140	μA	
I_{REV}	Reverse Leakage Current	Disabled, $V_{IN} = 0\text{V}$, $V_{OUT} = 5.5\text{V}$, I_{REV} at V_{IN}	—	0.01	1	μA	
Power Switch							
$R_{DS(ON)}$	Switch On-Resistance	SOT26 (Type A1) Package	$T_J = +25^\circ\text{C}$, $V_{IN} = 5.0\text{V}$	—	65	90	m Ω
			$-40^\circ\text{C} \leq T_A \leq +85^\circ\text{C}$	—	—	135	
		W-DFN2020-6 (Type A1) Package	$T_J = +25^\circ\text{C}$, $V_{IN} = 5.0\text{V}$	—	65	90	
			$-40^\circ\text{C} \leq T_A \leq +85^\circ\text{C}$	—	—	135	
t_{r}	Output Turn-On Rise Time	$V_{IN} = 5.5\text{V}$, $C_L = 1\mu\text{F}$, $R_{LOAD} = 100\Omega$. See Figure 1	—	0.5	1.5	ms	
		$V_{IN} = 3.0\text{V}$, $C_L = 1\mu\text{F}$, $R_{LOAD} = 100\Omega$	—	0.3	1	ms	
t_f	Output Turn-Off Fall Time	$V_{IN} = 5.5\text{V}$, $C_L = 1\mu\text{F}$, $R_{LOAD} = 100\Omega$. See Figure 1	0.1	—	0.5	ms	
		$V_{IN} = 3.0\text{V}$, $C_L = 1\mu\text{F}$, $R_{LOAD} = 100\Omega$	0.1	—	0.5	ms	
Current Limit							
I_{LIMIT}	Current-Limit Threshold (Maximum DC Output Current), $V_{IN} = 5\text{V}$, $V_{OUT} = 4.5\text{V}$	$R_{LIM} = 10\text{k}\Omega$	$T_A = +25^\circ\text{C}$	2478	2665	2852	mA
			$-40^\circ\text{C} \leq T_A \leq +85^\circ\text{C}$	2398	2665	2931	
		$R_{LIM} = 15\text{k}\Omega$	$T_A = +25^\circ\text{C}$	1614	1735	1856	
			$-40^\circ\text{C} \leq T_A \leq +85^\circ\text{C}$	1561	1735	1908	
		$R_{LIM} = 20\text{k}\Omega$	$T_A = +25^\circ\text{C}$	1196	1286	1376	
			$-40^\circ\text{C} \leq T_A \leq +85^\circ\text{C}$	1157	1286	1414	
		$R_{LIM} = 49.9\text{k}\Omega$	$T_A = +25^\circ\text{C}$	456	490	524	
			$-40^\circ\text{C} \leq T_A \leq +85^\circ\text{C}$	441	490	539	
		$R_{LIM} = 210\text{k}\Omega$	$T_A = +25^\circ\text{C}$	95	125	155	
		R_{LIM} Shorted to GND		40	80	120	
I_{SHORT}	Short-Circuit Current Limit, OUT Connected to GND	$R_{LIM} = 10\text{k}\Omega$, $T_A = +25^\circ\text{C}$	—	700	—	mA	
		$R_{LIM} = 15\text{k}\Omega$, $T_A = +25^\circ\text{C}$	—	470	—		
		$R_{LIM} = 20\text{k}\Omega$, $T_A = +25^\circ\text{C}$	—	350	—		
		$R_{LIM} = 49.9\text{k}\Omega$, $T_A = +25^\circ\text{C}$	—	140	—		
		$R_{LIM} = 210\text{k}\Omega$, $T_A = +25^\circ\text{C}$	—	35	—		
		R_{LIM} Shorted to GND, $T_A = +25^\circ\text{C}$	—	80	—		
Enable Pin							
$I_{LEAK-EN}$	EN Input Leakage Current	$V_{IN} = 5\text{V}$, $V_{EN} = 0\text{V}$ and 5.5V	-2	—	2	μA	
t_{ON}	Turn-On Time	$C_L = 1\mu\text{F}$, $R_L = 100\Omega$. See Figure 1	—	—	4	ms	
t_{OFF}	Turn-Off Time	$C_L = 1\mu\text{F}$, $R_L = 100\Omega$. See Figure 1	—	—	1	ms	
Output Discharge							
R_{DIS}	Discharge Resistance (Note 9)	$V_{IN} = 5\text{V}$, Disabled, $I_{OUT} = 1\text{mA}$	—	600	—	Ω	

Notes: 8. Pulse-testing techniques maintain junction temperature close to ambient temperature; thermal effects must be taken into account separately.
9. The discharge function is active when the device is disabled (when enable is de-asserted or during power-up power-down when $V_{IN} < V_{UVLO}$). The discharge function offers a resistive discharge path for the external storage capacitor for limited time.

Electrical Characteristics (continued) (@ $T_A = +25^\circ\text{C}$, $V_{IN} = 3.0\text{V}$ to 5.5V , $V_{EN} = 0\text{V}$ or $V_{EN} = V_{IN}$, $R_{FAULT} = 10\text{k}\Omega$, unless otherwise specified.)

Symbol	Parameter	Test Conditions (Note 8)	Min	Typ	Max	Unit
Reverse Voltage Protection						
V_{RVP}	Reverse-Voltage Comparator Trip Point	$V_{OUT} - V_{IN}$	—	65	—	mV
I_{ROCP}	Reverse Current Limit	$V_{OUT} - V_{IN} = 150\text{mV}$	—	0.32	—	A
t_{TRIG}	Time from Reverse-Voltage Condition to MOSFET Turn Off	$V_{IN} = 5\text{V}$	2	6	20	ms
Fault Flag						
V_{OL}	FAULT Output Low Voltage	$I_{FAULT} = 1\text{mA}$	—	—	180	mV
I_{FOH}	FAULT Off Current	$V_{FAULT} = 5.5\text{V}$	—	—	1	μA
t_{BLANK}	FAULT Blanking Time	Assertion or deassertion due to overcurrent and overtemperature condition	2	6	20	ms
Thermal Shutdown						
T_{SHDN}	Thermal Shutdown Threshold	Enabled	—	+145	—	$^\circ\text{C}$
T_{HYS}	Thermal Shutdown Hysteresis	Only for AP22652 and AP22653	—	+40	—	$^\circ\text{C}$

Typical Performance Characteristics

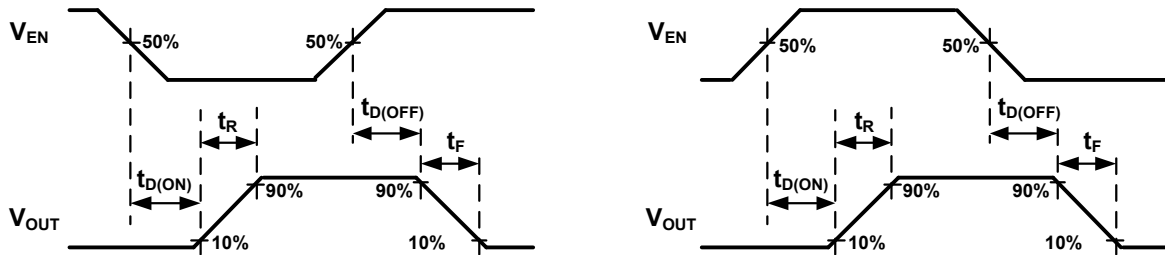

Figure 1. Voltage Waveforms: AP22652/52A (Left), AP22653/53A (Right)

Typical Performance Characteristics (continued)

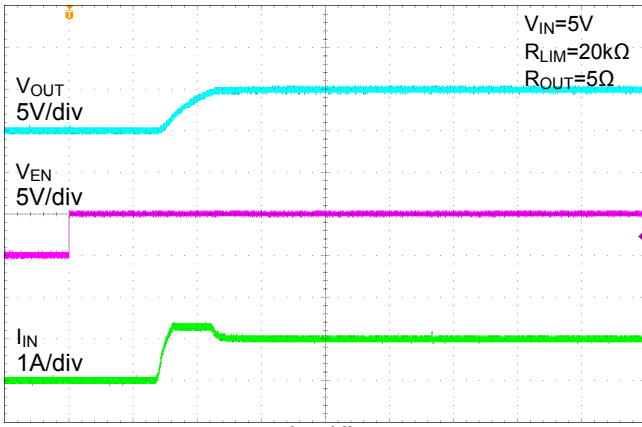

Figure 2. Turn-On Delay and Rise Time

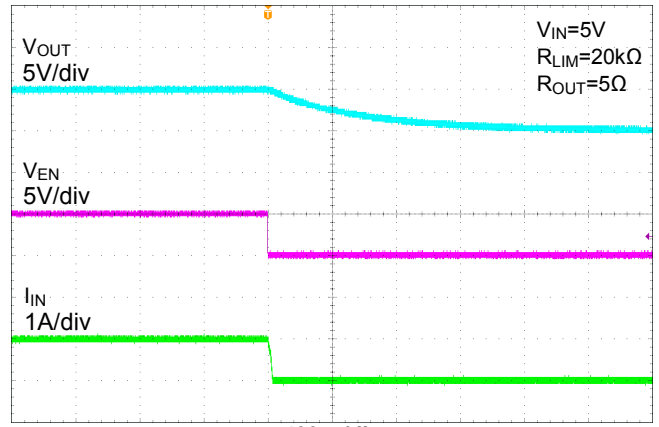

Figure 3. Turn-Off Delay and Fall Time

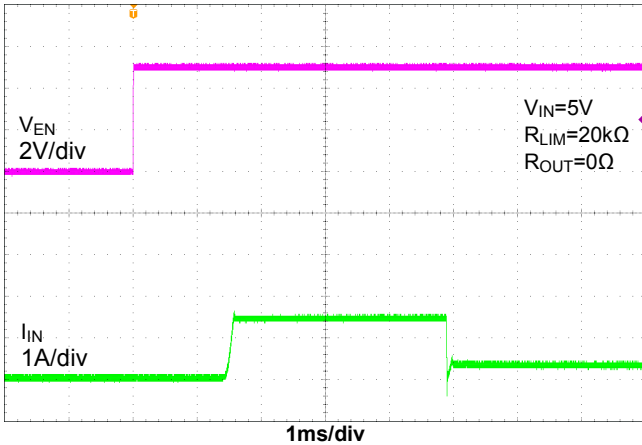

Figure 4. Device Enabled into Short-Circuit

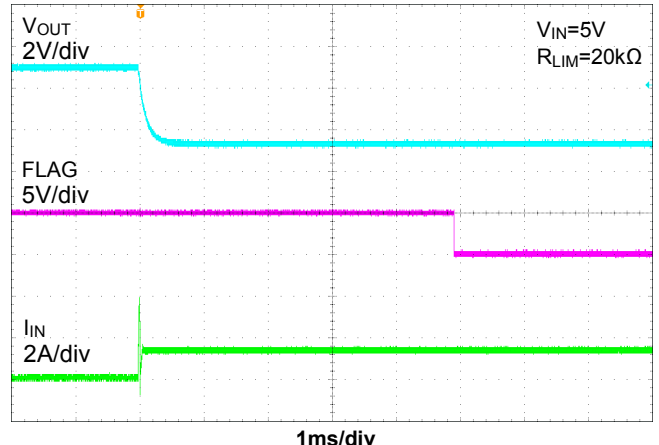

Figure 5. No Load to 1Ω Transient Response

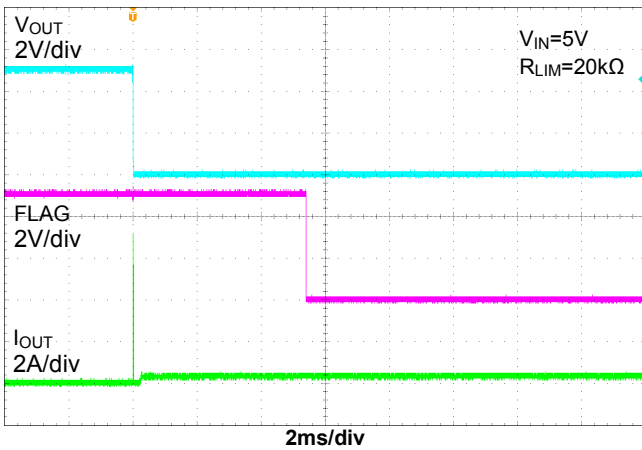

Figure 6. Short-Circuit Current Limit Response

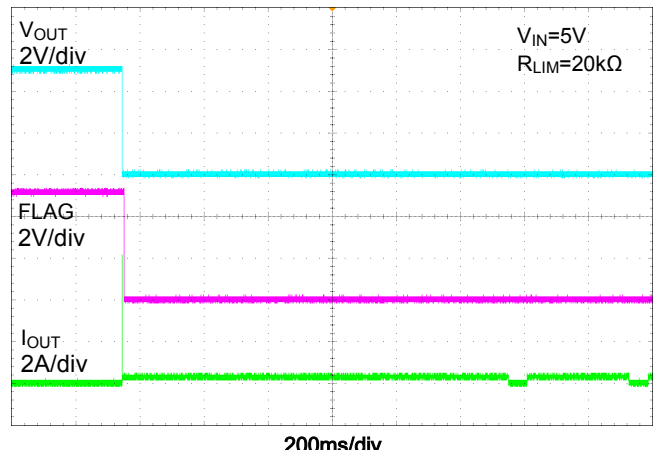

Figure 7. Extended Short-Circuit into Thermal Cycles

Typical Performance Characteristics (continued)

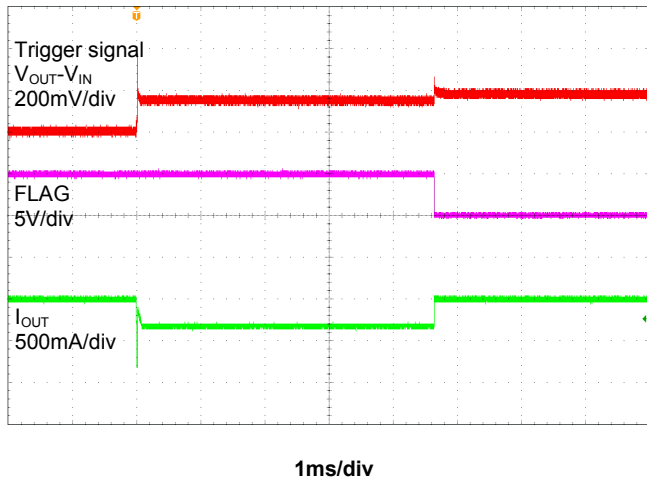

Figure 8. Reverse Current Limit Response

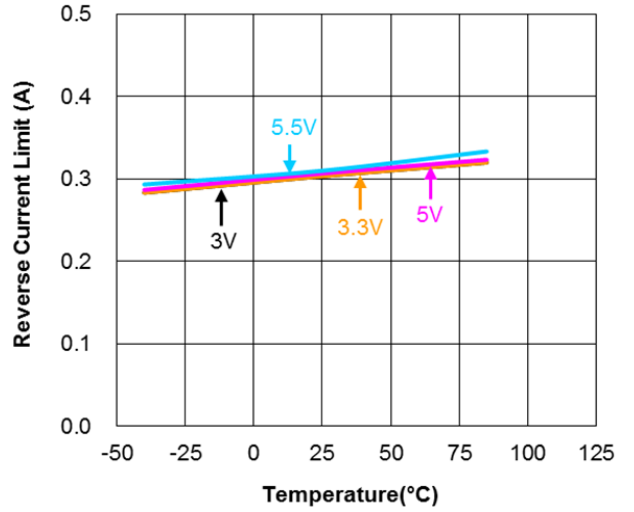

Figure 9. Reverse Current Limit vs. Temperature

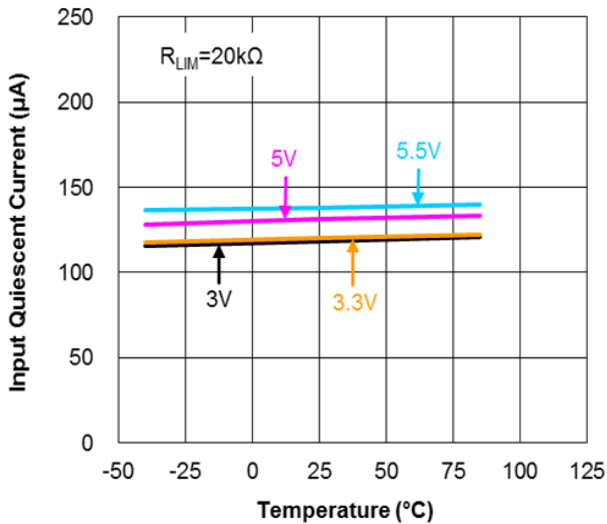

Figure 10. Input Quiescent Current vs. Temperature

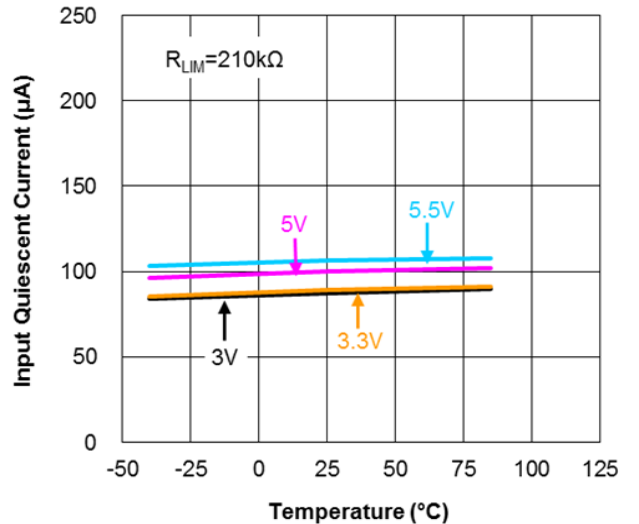

Figure 11. Input Quiescent Current vs. Temperature

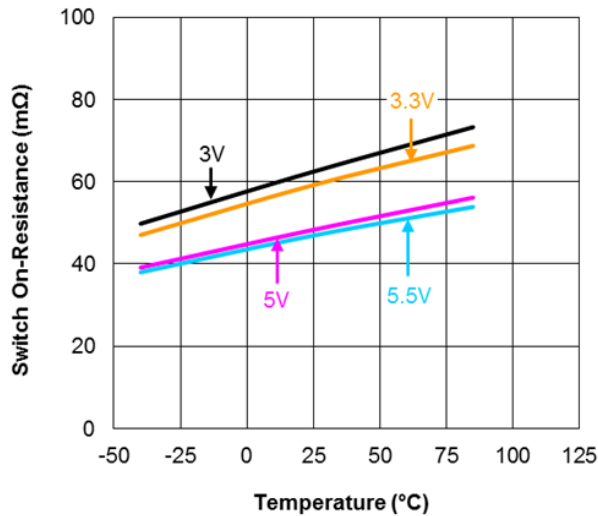

Figure 12. Switch On-Resistance vs. Temperature

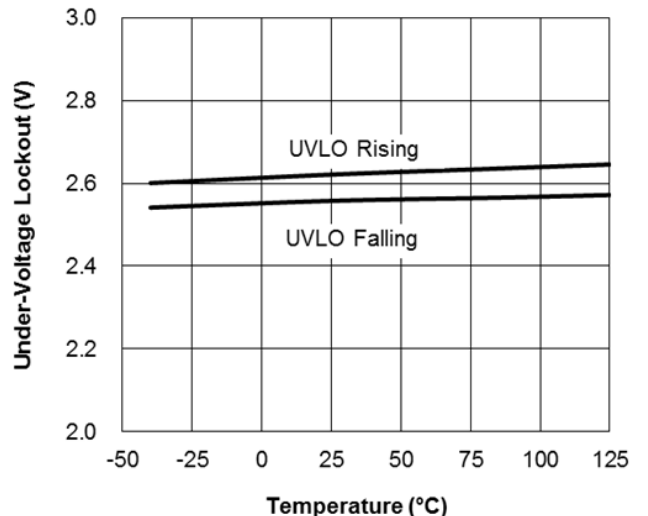

Figure 13. Under-Voltage Lock Out vs. Temperature

Application Information

The AP22652/52A and AP22653/53A are integrated high-side power switches optimized for Universal Serial Bus (USB) that require protection functions. The power switches are equipped with a driver that controls the gate voltage and incorporates slew-rate limitation. This, along with the various protection features and special functions, makes these power switches ideal for hot-swap or hot-plug applications.

Protection Features

Undervoltage Lockout (UVLO)

Whenever the input voltage falls below UVLO threshold (~2.5V), the power switch is turned off. This facilitates the design of hot-insertion systems where it is not possible to turn off the power switch before input power is removed.

Overcurrent and Short-Circuit Protection

An internal sensing FET is employed to check for overcurrent conditions. Unlike current-sense resistors, sense FETs do not increase the series resistance of the current path. When an overcurrent condition is detected, AP22652 and AP22653 maintain a constant output current and reduce the output voltage accordingly. Complete shutdown occurs only if the fault stays long enough to activate thermal limiting.

For AP22652A/53A, when an overcurrent condition is detected, the devices will limit the current until the overload condition is removed or the internal deglitch time (6ms typical) is reached, and AP22652A/53A will be turned off. AP22652A/53A will remain latched off until power is cycled or the device enable is toggled.

The different overload conditions and the corresponding response of the AP22652/52A and AP22653/53A are outlined below:

NO.	Conditions	Explanation	Behavior of the AP22652 and AP22653
1	Short-circuit condition at start-up	Output is shorted before input voltage is applied or before the part is enabled.	The IC senses the short circuit and immediately clamps output current to a certain safe level namely I_{SHORT} .
2	Short-circuit or overcurrent condition	Short-Circuit or Overload condition that occurs when the part is enabled.	<ul style="list-style-type: none"> At the instance the overload occurs, higher current may flow for a very short period of time before the current limit function can react. After the current limit function has tripped (reached the over-current trip threshold), the device switches into current limiting mode and the current is clamped at I_{SHORT}/I_{LIMIT}.
3	Gradual increase from nominal operating current to I_{LIMIT}	Load increases gradually until the current-limit threshold. (I_{TRIG})	The current rises until I_{LIMIT} or thermal limit. Once the threshold has been reached, the device switches into its current limiting mode and is set at I_{LIMIT} .

NO.	Conditions	Explanation	Behavior of the AP22652A/53A
1	Short-circuit condition at start-up	Output is shorted before input voltage is applied or before the part is enabled	The IC senses the short circuit and immediately clamps output current to a certain safe level namely I_{SHORT} . When the internal deglitch time (6ms typical) is reached and the devices will be turned off.
2	Short-circuit or overcurrent condition	Short-Circuit or Overload condition that occurs when the part is enabled.	<ul style="list-style-type: none"> At the instance the overload occurs, higher current may flow for a very short period of time before the current limit function can react. After the current limit function has tripped (reached the over-current trip threshold), the device switches into current limiting mode and the current is clamped at I_{SHORT}/I_{LIMIT}. When the internal deglitch time (6ms typical) is reached and the devices will be turned off.
3	Gradual increase from nominal operating current to I_{LIMIT}	Load increases gradually until the current-limit threshold. (I_{TRIG})	The current rises until I_{LIMIT} or thermal limit. Once the threshold has been reached, the device switches into its current limiting mode and is set at I_{LIMIT} . When the internal deglitch time (6ms typical) is reached and the devices will be turned off.

Application Information (continued)

Current-Limit Threshold Programming

The current-limit threshold can be programmed using an external resistor. The current-limit threshold is proportional to the current sourced out of I_{LIM} .

The recommended 1% resistor range for R_{LIM} is $10k\Omega \leq R_{LIM} \leq 210k\Omega$. Figure 14 includes current-limit tolerance due to variations caused by temperature and process. This graph does not include the external resistor tolerance. The traces routing the R_{LIM} resistor to the AP22652/52A and AP22653/53A should be as short as possible to reduce parasitic effects on the current-limit accuracy.

To design below a maximum current-limit threshold, find the intersection of R_{LIM} and the maximum desired load current on the $I_{OS(max)}$ (I_{LIM}) curve and choose a value of R_{LIM} above this value. Programming the current limit below a maximum threshold is important to avoid current limiting upstream power supplies causing the input voltage bus to drop. The resulting minimum current-limit threshold is the intersection of the selected value of R_{LIM} and the $I_{OS(min)}$ (I_{LIM}) curve.

Best-Fit Current-Limit Threshold Equations (I_{LIMIT}):

$$I_{LIMIT_Min}[mA] = 28955/R[k\Omega]^{1.075} \quad I_{LIMIT_Typ}[mA] = 30321/R[k\Omega]^{1.055} \quad I_{LIMIT_Max}[mA] = 31033/R[k\Omega]^{1.031}$$

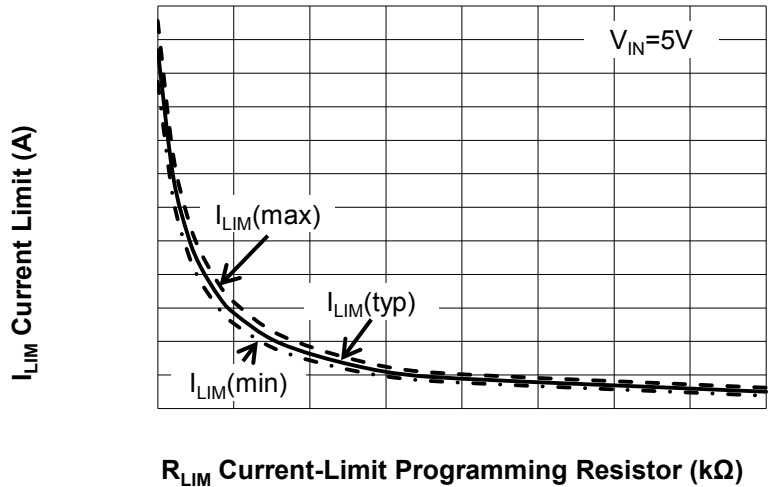

Figure 14. Current-Limit Threshold vs. R_{LIM}

Thermal Protection

Thermal protection prevents the IC from damage when the die temperature exceeds safe margins. This mainly occurs when heavy-overload or short-circuit faults are present for extended periods of time. The AP22652/52A and AP22653/53A implement a thermal sensing to monitor the operating junction temperature of the power distribution switch. Once the die temperature rises to approximately +145°C, the thermal protection feature activates as follows: The internal thermal sense circuitry turns the power switch off and the FAULT output is asserted, thus preventing the power switch from damage. Hysteresis in the thermal sense circuit allows the device to cool down by approximately +40°C before the output is turned back on. This built-in thermal hysteresis feature is an excellent feature, as it avoids undesirable oscillations of the thermal protection circuit.

Reverse-Current and Reverse-Voltage Protection

The USB specification does not allow an output device to source current back into the USB port. In a normal MOSFET switch, current will flow in reverse direction (from the output side to the input side) when the output side voltage is higher than the input side. A reverse-current limit (ROCP) feature is implemented in the AP22652/52A and AP22653/53A to limit such back currents. The ROCP circuit is activated when the output voltage is higher than the input voltage. After the reverse current circuit has tripped (reached the reverse current trip threshold), the current is clamped at this I_{ROCP} level.

In addition to ROCP, reverse overvoltage protection (ROVP) is also implemented. The ROVP circuit is activated by the reverse voltage comparator trip point; i.e., the difference between the output voltage and the input voltage.

For AP22652/53, once ROVP is activated, FAULT assertion occurs at a de-glitch time of 6ms. Recovery from ROVP is automatic when the fault is removed. FAULT de-assertion de-glitch time is same as the de-assertion time.

For AP22652A/53A, once ROVP is activated and when the condition exists for more than 5ms (typ), output device is disabled and shut down. This is called the "Time from Reverse-Voltage Condition to MOSFET Turn Off". FAULT assertion occurs at a de-glitch time of 6ms after ROVP is reached. Recovery from this fault is achieved by recycling power or toggling EN. FAULT de-assertion de-glitch time is same as the de-assertion time.

Application Information (continued)

Special Functions

Discharge Function

When enable is de-asserted, or when the input voltage is under UVLO level, the discharge function is active. The output capacitor is discharged through an internal NMOS that has a discharge resistance of 600Ω. Hence, the output voltage drops down to zero. The time taken for discharge is dependent on the RC time constant of the resistance and the output capacitor.

FAULT Response

The FAULT open-drain output goes active low for any of following faults: overcurrent, OUT pin short-circuit, reverse-voltage condition, or thermal shutdown. The time from when a fault condition is encountered to when the FAULT output goes low is 6ms (typ). The FAULT output remains low until overcurrent, OUT pin short-circuit, and overtemperature conditions are removed. Connecting a heavy capacitive load to the output of the device can cause a momentary overcurrent condition, which does not trigger the FAULT due to the 6ms deglitch timeout. This 6ms timeout is also applicable for overcurrent recovery and overtemperature recovery. The AP22652 and AP22653 are designed to eliminate erroneous overcurrent reporting without the need for external components, such as an RC delay network.

For the AP22652/52A and AP22653/53A when the reverse voltage condition is triggered, FAULT output goes low after 6ms (typ). This 6ms (typ) timeout is also applicable for the recovery from reverse voltage fault. The Flag Current is always higher than Current Limit Threshold to ensure maximum loading consuming.

When the ILIM pin is shorted to GND, current-limit threshold and short-circuit current limit will be clamped at typically 100mA. When the ILIM pin is shorted to GND, the AP22652/53 and AP22652A/53A $\overline{\text{FAULT}}$ pin will assert during current-limiting and short-circuit conditions.

For latch-off version, once Fault signal is triggered, the device will stay off until EN pin is toggled or power is restarted.

Power Supply Considerations

A 0.01μF to 0.1μF, X7R or X5R ceramic bypass capacitor between IN and GND, close to the device, is recommended. This limits the input voltage drop during line transients. Placing a high-value electrolytic capacitor on the input (10μF minimum) and output pin (120μF) is recommended when the output load is heavy. This precaution also reduces power-supply transients that may cause ringing on the input. Additionally, bypassing the device output with a 0.1μF to 4.7μF ceramic capacitor improves the immunity of the device to short-circuit transients. This capacitor also prevents output from going negative during turn-off due to parasitic inductance.

Power Dissipation and Junction Temperature

The low on-resistance of the internal MOSFET allows the small surface-mount packages to pass large current. Using the maximum operating ambient temperature (T_A) and $R_{DS(ON)}$, the power dissipation can be calculated by:

$$P_D = R_{DS(ON)} \times I^2$$

Finally, calculate the junction temperature:

$$T_J = P_D \times \theta_{JA} + T_A$$

Where:

T_A = Ambient temperature °C

θ_{JA} = Thermal resistance

P_D = Total power dissipation

Generic Hot-Plug Applications

In many applications, it may be necessary to remove modules or PC boards while the main unit is still operating. These are considered hot-plug applications. Such implementations require the control of current surges seen by the main power supply and the card being inserted. The most effective way to control these surges is to limit and slowly ramp the current and voltage being applied to the card, similar to the way in which a power supply normally turns on. Due to the controlled rise and fall times of the AP22652/52A and AP22653/53A these devices can be used to provide a softer start-up to devices being hot-plugged into a powered system. The UVLO feature of the AP22652/52A and AP22653/53A also ensures that the switch is off after the card has been removed, and that the switch is off during the next insertion.

Generic Hot-Plug Applications

By placing the AP22652/52A and AP22653/53A between the V_{CC} input and the rest of the circuitry, the input power reaches these devices first after insertion. The typical rise time of the switch is approximately 1ms, providing a slow voltage ramp at the output of the device. This implementation controls system surge current and provides a hot-plugging mechanism for any device.

Ordering Information

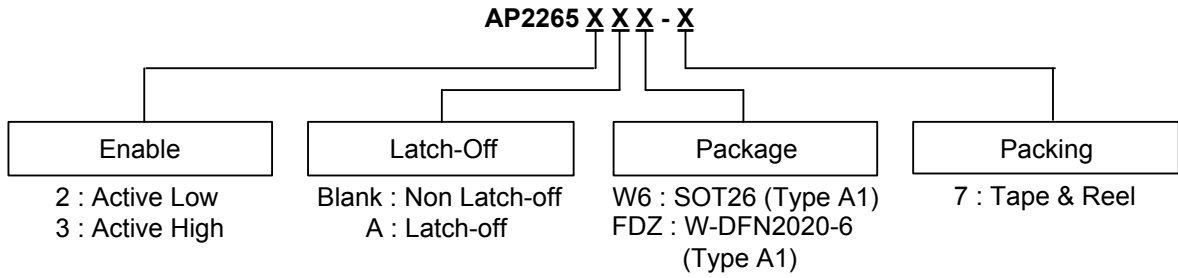

Type	Part Number	Enable Active	Output Fault Condition	Package Code	Packaging	7" Tape and Reel	
						Quantity	Part Number Suffix
Consumer Grade	AP22652W6-7	Low	Output Current Limits	W6	SOT26 (Type A1)	3000/Tape & Reel	-7
	AP22652FDZ-7			FDZ	W-DFN2020-6 (Type A1)	3000/Tape & Reel	-7
	AP22653W6-7	High		W6	SOT26 (Type A1)	3000/Tape & Reel	-7
	AP22653FDZ-7			FDZ	W-DFN2020-6 (Type A1)	3000/Tape & Reel	-7
	AP22652AW6-7	Low	Output Latches Off	W6	SOT26 (Type A1)	3000/Tape & Reel	-7
	AP22652AFDZ-7			FDZ	W-DFN2020-6 (Type A1)	3000/Tape & Reel	-7
	AP22653AW6-7	High		W6	SOT26 (Type A1)	3000/Tape & Reel	-7
	AP22653AFDZ-7			FDZ	W-DFN2020-6 (Type A1)	3000/Tape & Reel	-7

Marking Information

(1) SOT26 (Type A1)

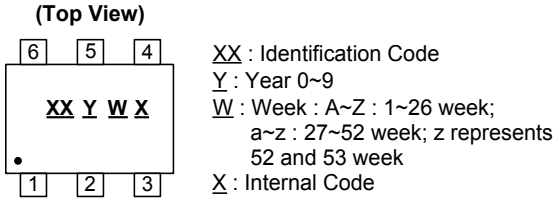

Type	Part Number	Package	Identification Code
Consumer Grade	AP22652W6-7	SOT26 (Type A1)	FJ
	AP22653W6-7	SOT26 (Type A1)	FK
	AP22652AW6-7	SOT26 (Type A1)	FR
	AP22653AW6-7	SOT26 (Type A1)	FS

(2) W-DFN2020-6 (Type A1)

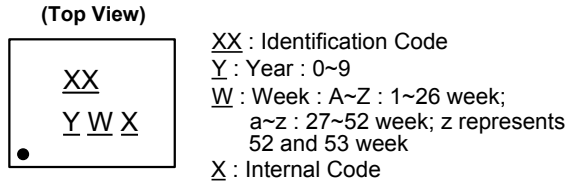

Type	Part Number	Package	Identification Code
Consumer Grade	AP22652FDZ-7	W-DFN2020-6 (Type A1)	FJ
	AP22653FDZ-7	W-DFN2020-6 (Type A1)	FK
	AP22652AFDZ-7	W-DFN2020-6 (Type A1)	FR
	AP22653AFDZ-7	W-DFN2020-6 (Type A1)	FS

Package Outline Dimensions

Please see <http://www.diodes.com/package-outlines.html> for the latest version.

(1) Package Type: SOT26 (Type A1)

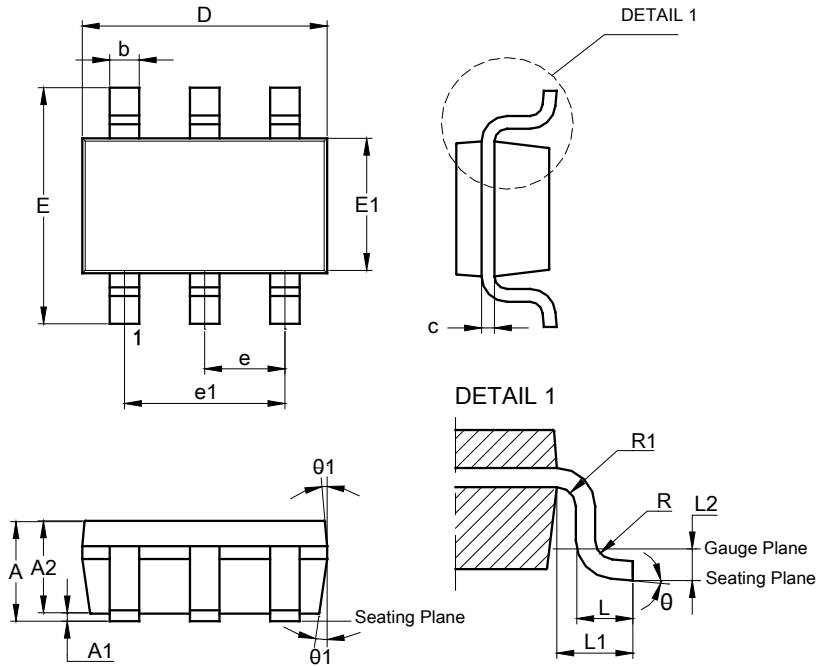

SOT26 (Type A1)			
Dim	Min	Max	Typ
A	--	1.45	--
A1	0.00	0.15	--
A2	0.90	1.30	1.15
b	0.30	0.50	--
c	0.08	0.22	--
D	2.80	3.00	2.90
E	2.70	2.90	2.80
E1	1.50	1.70	1.60
e	0.95 BSC		
e1	1.90 BSC		
L	0.30	0.60	0.45
L1	0.60 REF		
L2	0.25 BSC		
R	0.10	--	--
R1	0.10	0.25	--
theta	0°	8°	4°
theta1	5°	15°	10°
All Dimensions in mm			

(2) Package Type: W-DFN2020-6 (Type A1)

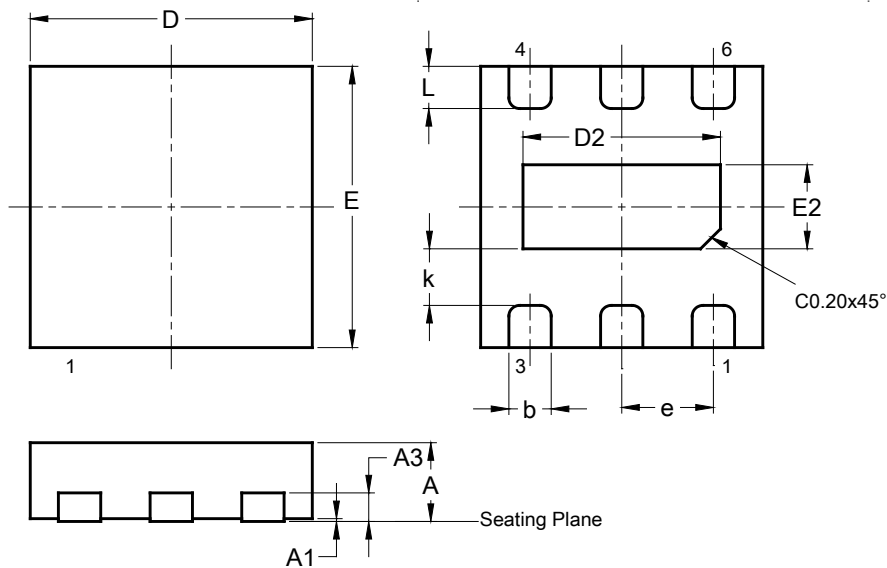

W-DFN2020-6 Type A1			
Dim	Min	Max	Typ
A	0.70	0.80	0.75
A1	0.00	0.05	0.02
A2	0.20 REF		
A3	0.20 REF		
b	0.25	0.35	0.30
D	1.90	2.10	2.00
D2	1.35	1.45	1.40
E	1.90	2.10	2.00
E2	0.55	0.65	0.60
e	0.65 BSC		
k	0.20	--	--
L	0.25	0.35	0.30
All Dimensions in mm			

Suggested Pad Layout

Please see <http://www.diodes.com/package-outlines.html> for the latest version.

(1) Package Type: SOT26 (Type A1)

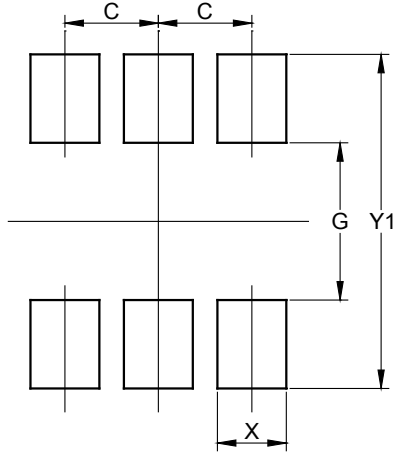

Dimensions	Value (in mm)
C	0.950
G	1.600
X	0.700
Y	0.900
Y1	3.400

(2) Package Type: W-DFN2020-6 (Type A1)

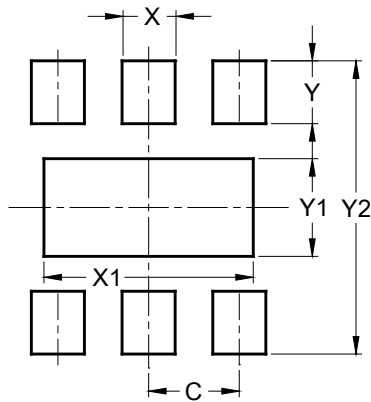

Dimensions	Value (in mm)
C	0.65
X	0.38
X1	1.50
Y	0.45
Y1	0.70
Y2	2.10

Mechanical Data

SOT26 (Type A1)

- Moisture Sensitivity: Level 1 per J-STD-020
- Terminals: Finish – Matte Tin Plated Leads, Solderable per MIL-STD-202, Method 208③
- Weight: 0.016 grams (Approximate)

W-DFN2020-6 (Type A1)

- Moisture Sensitivity: Level 1 per J-STD-020
- Terminals: Finish – Matte Tin Plated Leads, Solderable per MIL-STD-202, Method 208③
- Weight: 0.0075 grams (Approximate)

IMPORTANT NOTICE

1. DIODES INCORPORATED AND ITS SUBSIDIARIES (“DIODES”) MAKE NO WARRANTY OF ANY KIND, EXPRESS OR IMPLIED, WITH REGARDS TO ANY INFORMATION CONTAINED IN THIS DOCUMENT, INCLUDING, BUT NOT LIMITED TO, THE IMPLIED WARRANTIES OF MERCHANTABILITY, FITNESS FOR A PARTICULAR PURPOSE OR NON-INFRINGEMENT OF THIRD PARTY INTELLECTUAL PROPERTY RIGHTS (AND THEIR EQUIVALENTS UNDER THE LAWS OF ANY JURISDICTION).
2. The Information contained herein is for informational purpose only and is provided only to illustrate the operation of Diodes products described herein and application examples. Diodes does not assume any liability arising out of the application or use of this document or any product described herein. This document is intended for skilled and technically trained engineering customers and users who design with Diodes products. Diodes products may be used to facilitate safety-related applications; however, in all instances customers and users are responsible for (a) selecting the appropriate Diodes products for their applications, (b) evaluating the suitability of the Diodes products for their intended applications, (c) ensuring their applications, which incorporate Diodes products, comply the applicable legal and regulatory requirements as well as safety and functional-safety related standards, and (d) ensuring they design with appropriate safeguards (including testing, validation, quality control techniques, redundancy, malfunction prevention, and appropriate treatment for aging degradation) to minimize the risks associated with their applications.
3. Diodes assumes no liability for any application-related information, support, assistance or feedback that may be provided by Diodes from time to time. Any customer or user of this document or products described herein will assume all risks and liabilities associated with such use, and will hold Diodes and all companies whose products are represented herein or on Diodes’ websites, harmless against all damages and liabilities.
4. Products described herein may be covered by one or more United States, international or foreign patents and pending patent applications. Product names and markings noted herein may also be covered by one or more United States, international or foreign trademarks and trademark applications. Diodes does not convey any license under any of its intellectual property rights or the rights of any third parties (including third parties whose products and services may be described in this document or on Diodes’ website) under this document.
5. Diodes products are provided subject to Diodes’ Standard Terms and Conditions of Sale (<https://www.diodes.com/about/company/terms-and-conditions/terms-and-conditions-of-sales/>) or other applicable terms. This document does not alter or expand the applicable warranties provided by Diodes. Diodes does not warrant or accept any liability whatsoever in respect of any products purchased through unauthorized sales channel.
6. Diodes products and technology may not be used for or incorporated into any products or systems whose manufacture, use or sale is prohibited under any applicable laws and regulations. Should customers or users use Diodes products in contravention of any applicable laws or regulations, or for any unintended or unauthorized application, customers and users will (a) be solely responsible for any damages, losses or penalties arising in connection therewith or as a result thereof, and (b) indemnify and hold Diodes and its representatives and agents harmless against any and all claims, damages, expenses, and attorney fees arising out of, directly or indirectly, any claim relating to any noncompliance with the applicable laws and regulations, as well as any unintended or unauthorized application.
7. While efforts have been made to ensure the information contained in this document is accurate, complete and current, it may contain technical inaccuracies, omissions and typographical errors. Diodes does not warrant that information contained in this document is error-free and Diodes is under no obligation to update or otherwise correct this information. Notwithstanding the foregoing, Diodes reserves the right to make modifications, enhancements, improvements, corrections or other changes without further notice to this document and any product described herein. This document is written in English but may be translated into multiple languages for reference. Only the English version of this document is the final and determinative format released by Diodes.
8. Any unauthorized copying, modification, distribution, transmission, display or other use of this document (or any portion hereof) is prohibited. Diodes assumes no responsibility for any losses incurred by the customers or users or any third parties arising from any such unauthorized use.

Copyright © 2021 Diodes Incorporated

www.diodes.com

Looking for pricing, stock, or lifecycle information?

Click below to explore more details on WIN SOURCE:

- ⊖ [View AP22652AW6-7 on WIN SOURCE](#)
- ⊖ [Diodes Incorporated Information](#)

Optimize Your Supply Chain with WIN SOURCE Solutions

- ✓ Global Sourcing Solution
- ✓ Obsolete Management
- ✓ Cost Control Management
- ✓ Shortage Management
- ✓ Alternative Solution
- ✓ Excess Inventory Management