

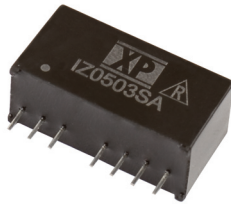

**THE DATASHEET OF  
IZ2415S**



# 3 Watts IZ Series



- Regulated Single & Dual Output
- Wide 2:1 Input Range
- SIP Package
- 1600 VDC Isolation
- Continuous Short Circuit Protection
- Remote On/Off
- 3 Year Warranty

## Specification

### Input

- Input Voltage Range • See table  
 Input Reflected Ripple Current • 35 mA pk-pk through 12  $\mu$ H inductor and 47  $\mu$ F capacitor, 5 Hz to 20 MHz  
 Input Filter • Capacitor

### Output

- Output Voltage • See table  
 Minimum Load • None<sup>(4)</sup>  
 Line Regulation •  $\pm 0.5\%$  max  
 Load Regulation •  $\pm 1.0\%$  max for a 25-100% load change  
 Setpoint Accuracy •  $\pm 1\%$  max  
 Ripple & Noise • 75 mV pk-pk max, 20 MHz bandwidth  
 Short Circuit Protection • Continuous with auto recovery (foldback)  
 Cross Regulation •  $\pm 5\%$  on dual output models<sup>(5)</sup>  
 Temperature Coefficient • 0.02%/C  
 Remote On/Off • Module "on" if pin 3 is open circuit. Module "off" by driving 3-6mA into pin 3. Maximum applied voltage 9.7VDC relative to -Vin. See below.

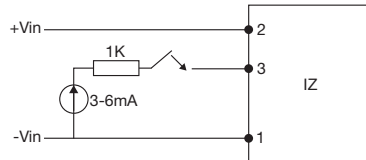

### General

- Efficiency • See table  
 Isolation Voltage • 1600 VDC  
 Isolation Resistance •  $10^9 \Omega$   
 Isolation Capacitance • 680 pF  
 Switching Frequency • 100-650 kHz  
 MTBF • >1.34 Mhrs to MIL-HDBK-217F at 25 °C, GB

### Environmental

- Operating Temperature • -40 °C to +100 °C, derate from 100% load at +70 °C to 0% load at +100 °C  
 Storage Temperature • -40 °C to +125 °C  
 Case Temperature • +100 °C max  
 Cooling • Convection cooled

### Safety

- Safety Approvals • UL60950-1, CAN/CSA C22.2 No.60950-1, UL62368-1, CE & UKCA meets all applicable directives & legislation

Input Voltage	No Load <sup>(1)</sup> Input Current	Output Voltage	Output Current	Efficiency	Max Capacitive Load	Model Number <sup>(2)</sup>
4.5-9.0 V	65 mA	3.3 V	700 mA	74%	2200 $\mu$ F	IZ0503SA
	70 mA	5.0 V	600 mA	76%	1000 $\mu$ F	IZ0505SA
	75 mA	12.0 V	250 mA	82%	470 $\mu$ F	IZ0512SA
	75 mA	15.0 V	200 mA	82%	220 $\mu$ F	IZ0515SA
	90 mA	$\pm 5.0$ V	$\pm 300$ mA	77%	$\pm 470$ $\mu$ F	IZ0505S
	90 mA	$\pm 12.0$ V	$\pm 125$ mA	81%	$\pm 220$ $\mu$ F	IZ0512S
9.0-18.0 V	90 mA	$\pm 15.0$ V	$\pm 100$ mA	82%	$\pm 100$ $\mu$ F	IZ0515S
	25 mA	3.3 V	700 mA	76%	2200 $\mu$ F	IZ1203SA
	35 mA	5.0 V	600 mA	81%	1000 $\mu$ F	IZ1205SA
	35 mA	12.0 V	250 mA	84%	470 $\mu$ F	IZ1212SA
	35 mA	15.0 V	200 mA	84%	220 $\mu$ F	IZ1215SA
	45 mA	$\pm 5.0$ V	$\pm 300$ mA	80%	$\pm 470$ $\mu$ F	IZ1205S
18.0-36.0 V	45 mA	$\pm 12.0$ V	$\pm 125$ mA	83%	$\pm 220$ $\mu$ F	IZ1212S
	45 mA	$\pm 15.0$ V	$\pm 100$ mA	82%	$\pm 100$ $\mu$ F	IZ1215S
	15 mA	3.3 V	700 mA	74%	2200 $\mu$ F	IZ2403SA
	15 mA	5.0 V	600 mA	79%	1000 $\mu$ F	IZ2405SA
	20 mA	12.0 V	250 mA	82%	470 $\mu$ F	IZ2412SA
	20 mA	15.0 V	200 mA	84%	220 $\mu$ F	IZ2415SA
36.0-72.0 V	20 mA	$\pm 5.0$ V	$\pm 300$ mA	80%	$\pm 470$ $\mu$ F	IZ2405S
	20 mA	$\pm 12.0$ V	$\pm 125$ mA	83%	$\pm 220$ $\mu$ F	IZ2412S
	20 mA	$\pm 15.0$ V	$\pm 100$ mA	83%	$\pm 100$ $\mu$ F	IZ2415S
	10 mA	3.3 V	700 mA	75%	2200 $\mu$ F	IZ4803SA
	10 mA	5.0 V	600 mA	78%	1000 $\mu$ F	IZ4805SA
	15 mA	12.0 V	250 mA	81%	470 $\mu$ F	IZ4812SA
	15 mA	15.0 V	200 mA	81%	220 $\mu$ F	IZ4815SA
	35 mA	$\pm 5.0$ V	$\pm 300$ mA	78%	$\pm 470$ $\mu$ F	IZ4805S
	20 mA	$\pm 12.0$ V	$\pm 125$ mA	80%	$\pm 220$ $\mu$ F	IZ4812S
	20 mA	$\pm 15.0$ V	$\pm 100$ mA	81%	$\pm 100$ $\mu$ F	IZ4815S

## Mechanical Details

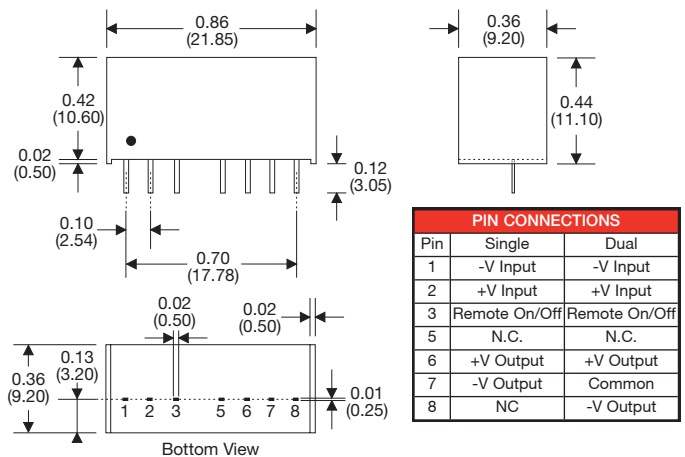



### Notes







1. Measured at nominal input voltage.
2. Minimum load of 25% required to meet load regulation & ripple & noise specifications.
3. Operation at no load will not damage the part but it may not meet all specifications.
4. When one output is set to 100% load and the other varies between 25-100% load.
5. Pin pitch tolerance:  $\pm 0.014$  ( $\pm 0.35$ )
6. Case tolerance:  $\pm 0.02$  ( $\pm 0.5$ )
7. Weight: SIP 0.009 lbs (3.9 g), DIP 0.013 lbs (5.9 g)
8. All dimensions in inches (mm)

## Looking for pricing, stock, or lifecycle information?

Click below to explore more details on WIN SOURCE:

-  [View IZ2415S on WIN SOURCE](#)
-  [XP Power Information](#)

## Optimize Your Supply Chain with WIN SOURCE Solutions

-  Global Sourcing Solution
-  Obsolete Management
-  Cost Control Management
-  Shortage Management
-  Alternative Solution
-  Excess Inventory Management